

Joseph Lstiburek, Ph.D., P.Eng, ASHRAE Fellow

Building Science

presented by www.buildingscience.com

Arrhenius Equation

For Every 10 Degree K Rise
Rate of Reaction Doubles

$$k = Ae^{-E_a/(RT)}$$

Damage Functions

Water

Heat

Ultra-violet Radiation

Vapor Pressure and Relative Humidity

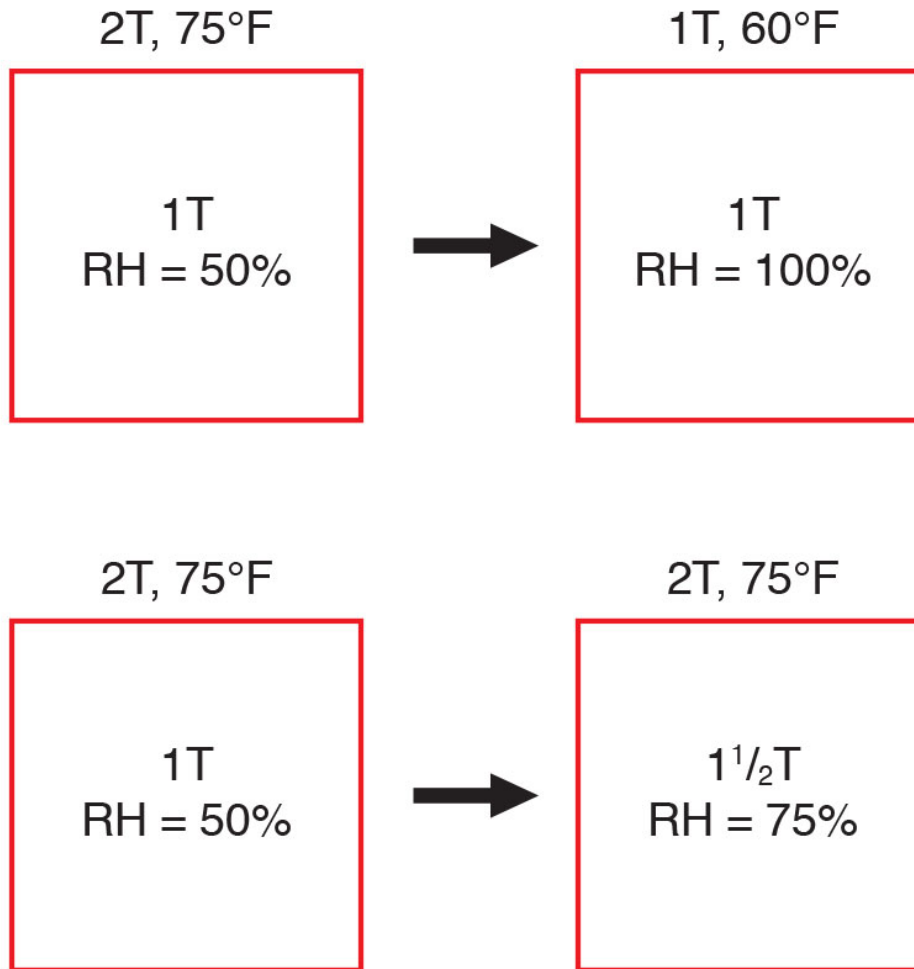

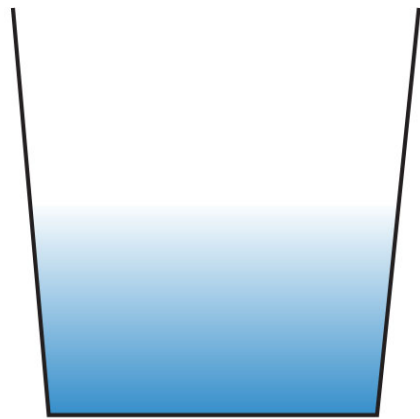

90°F
50% RH

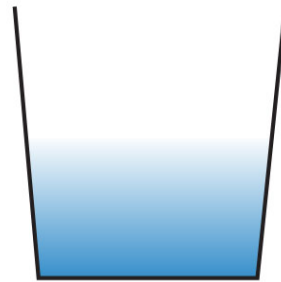

75°F
50% RH

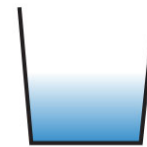

60°F
50% RH



45°F
50% RH



30°F
50% RH

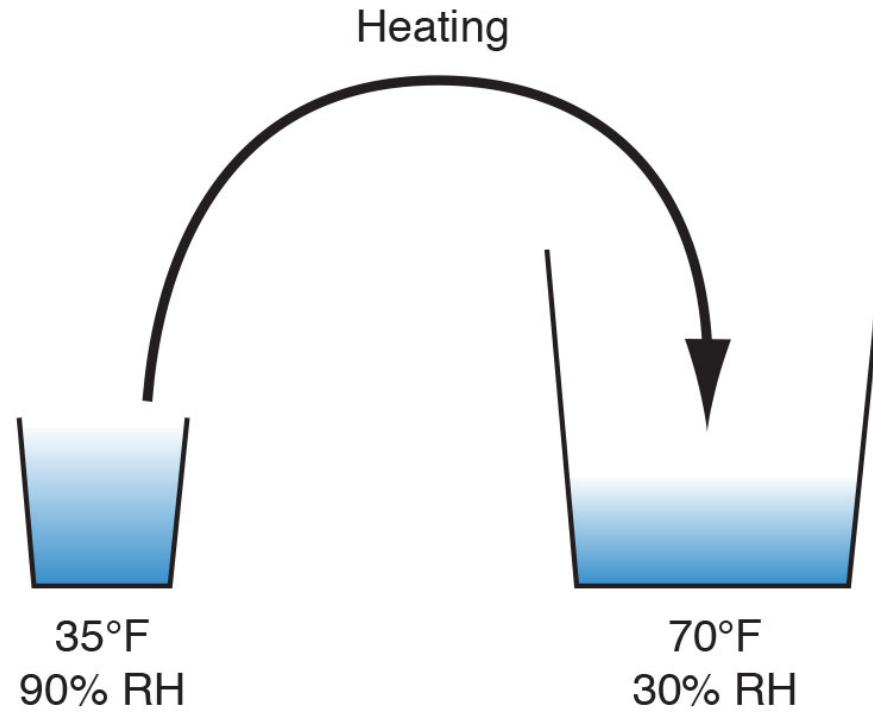

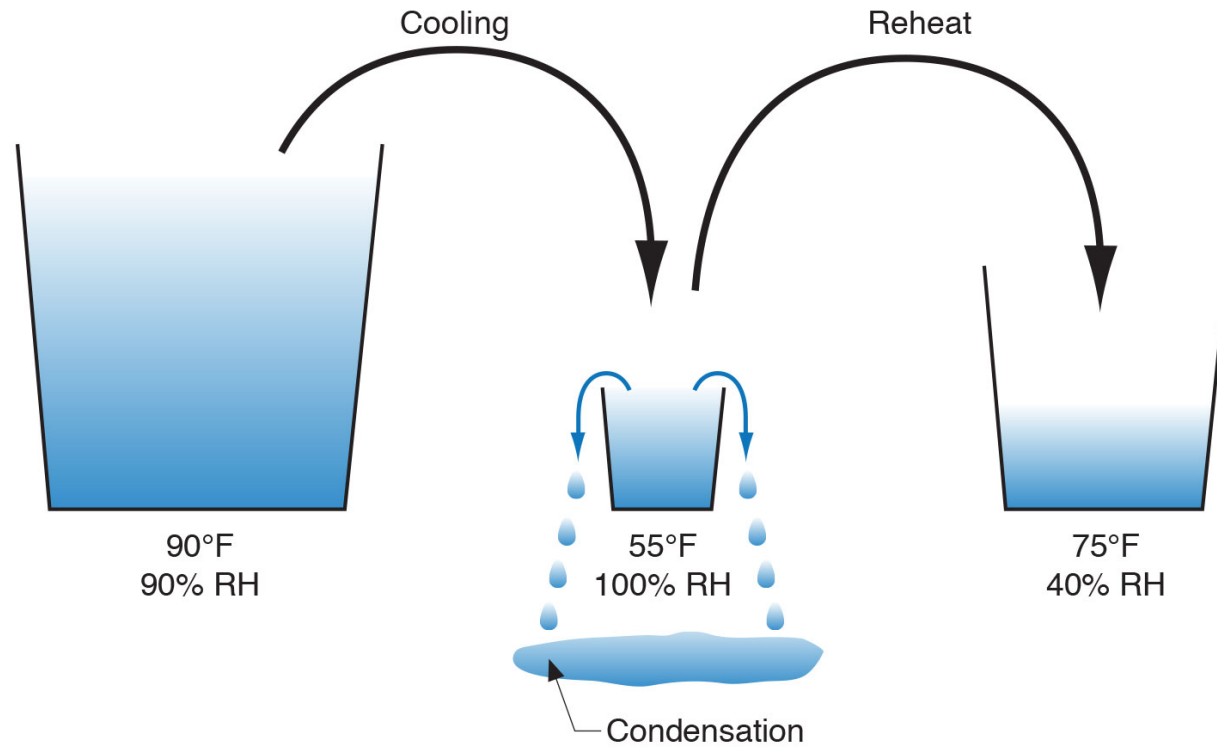

Sorption Isotherms

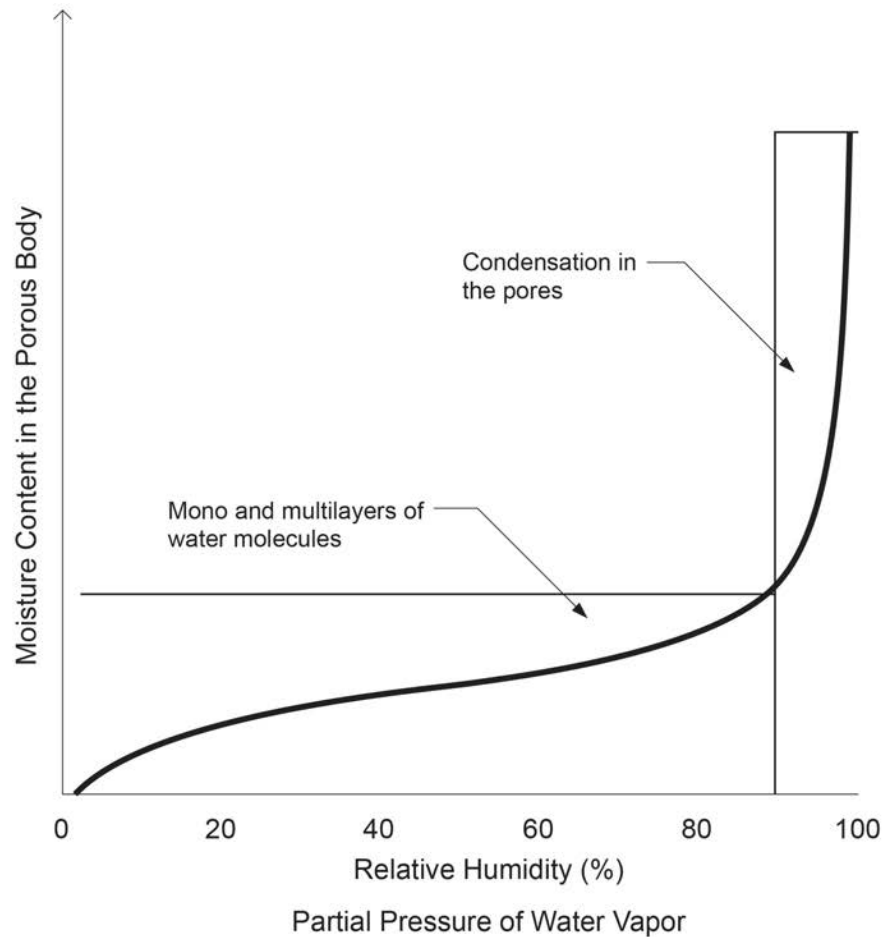

Change in the storage of moisture in a porous building material as the partial pressure of water vapor in the ambient air increases from zero to full saturation value at a given temperature.

Sorption Curve

From M.K. Kumaran, ASTM MNL 18-2nd Edition,
Moisture Control in Buildings, 2009

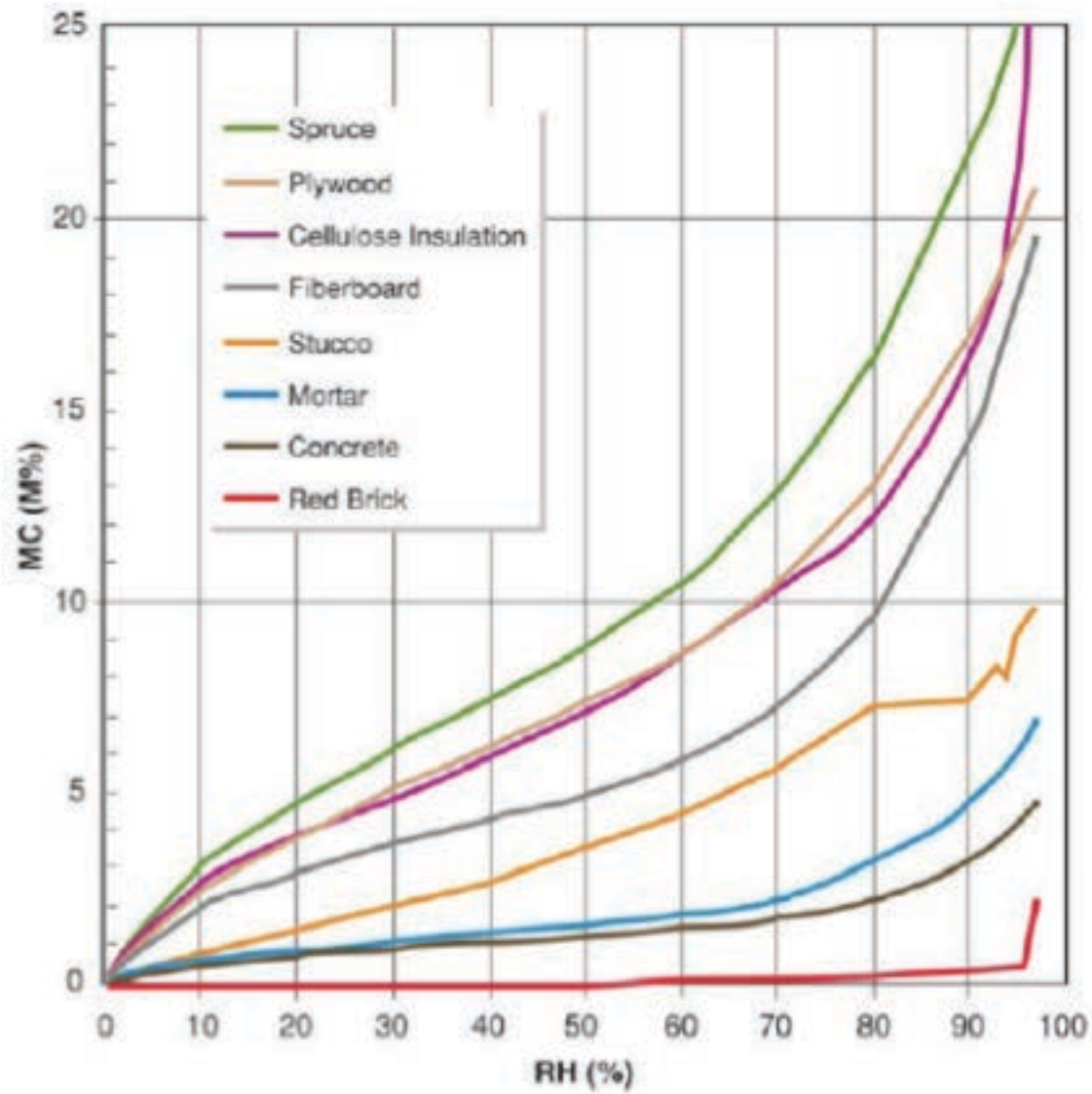

Moisture Content vs. Relative Humidity

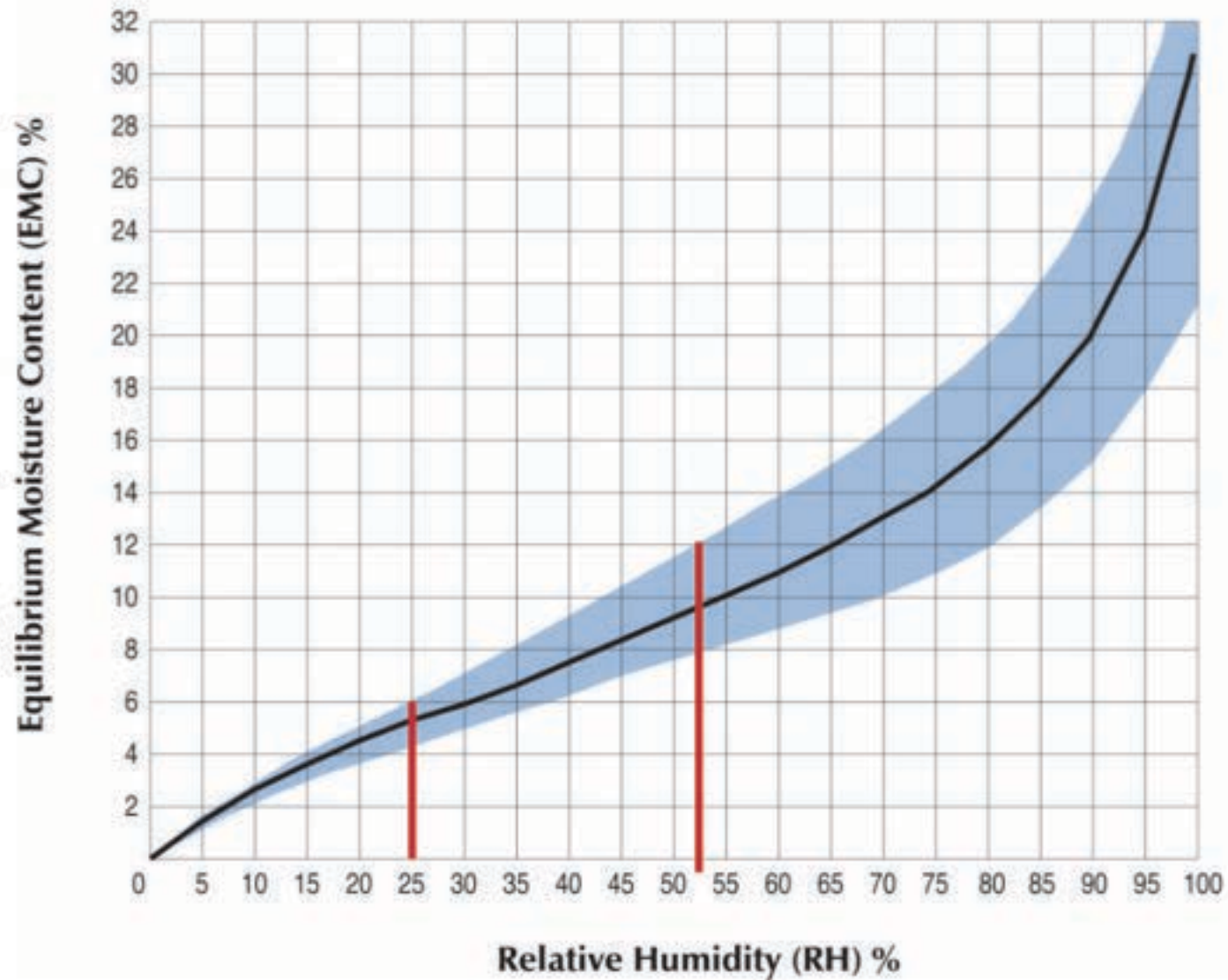

2nd Law of Thermodynamics

Heat Flow Is From Warm To Cold

Moisture Flow Is From Warm To Cold

Moisture Flow Is From More To Less

Air Flow Is From A Higher Pressure to a
Lower Pressure

Gravity Acts Down



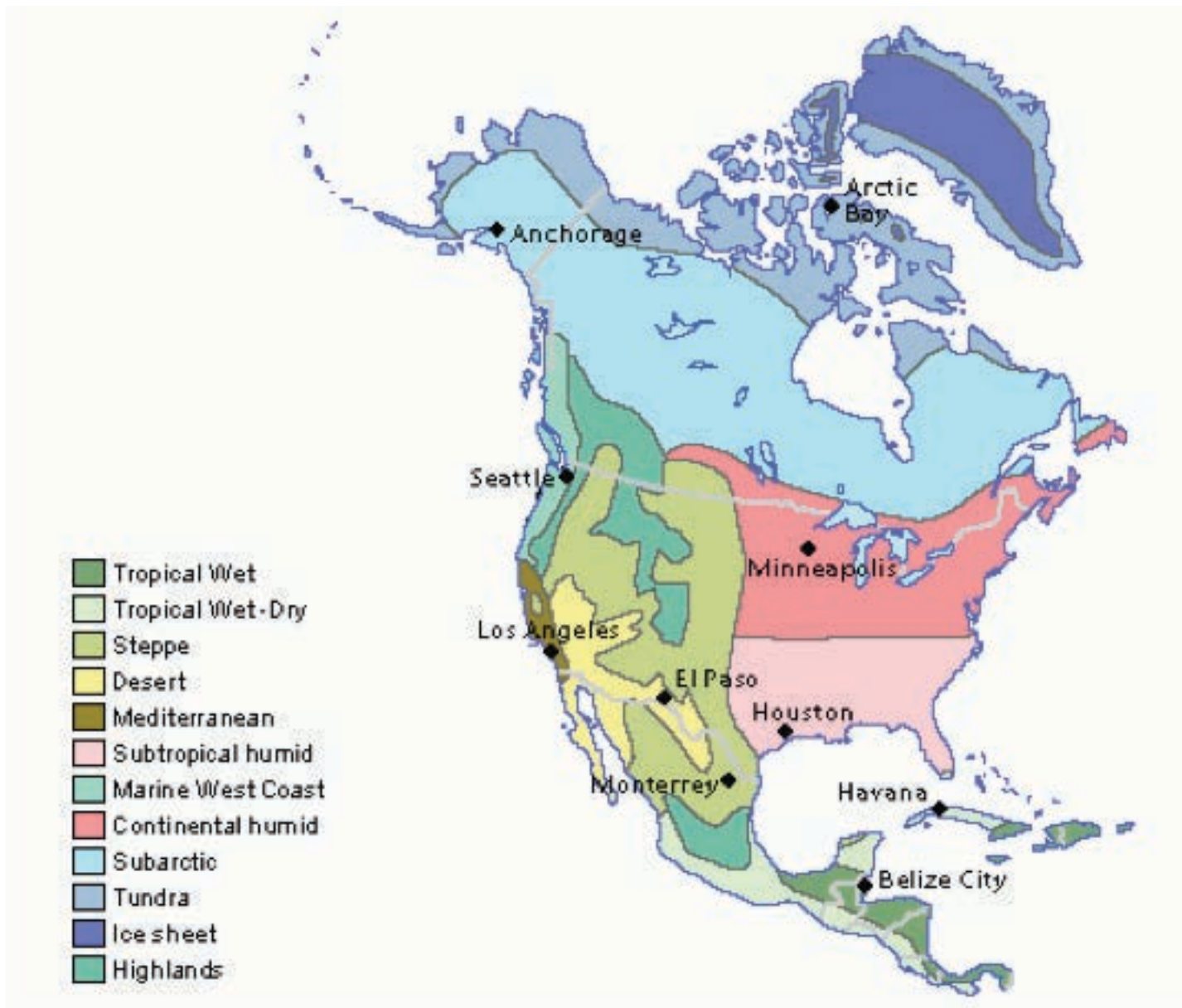

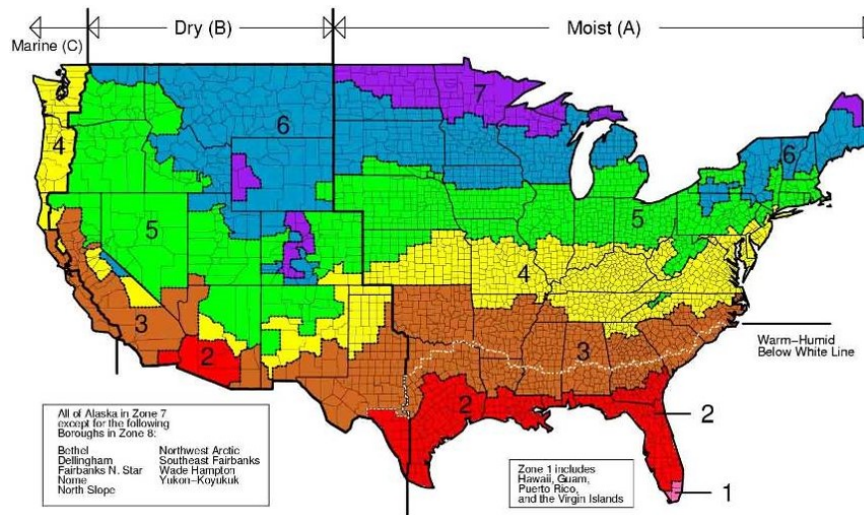







Exposure

Extreme		Over 60"
High		40" - 60"
Moderate		20" - 40"
Low		Under 20"

Vented Attics Are Climate Dependant

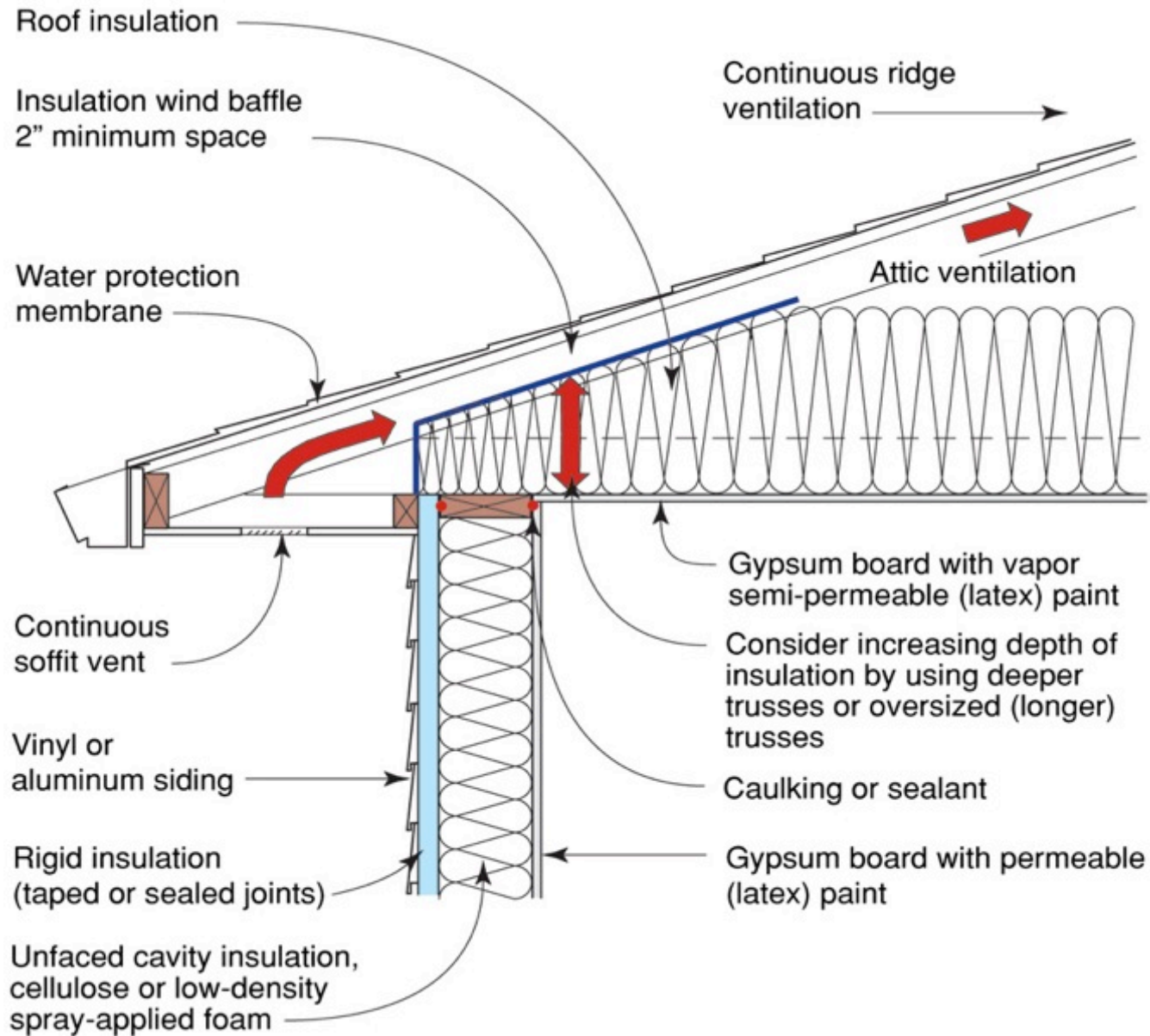

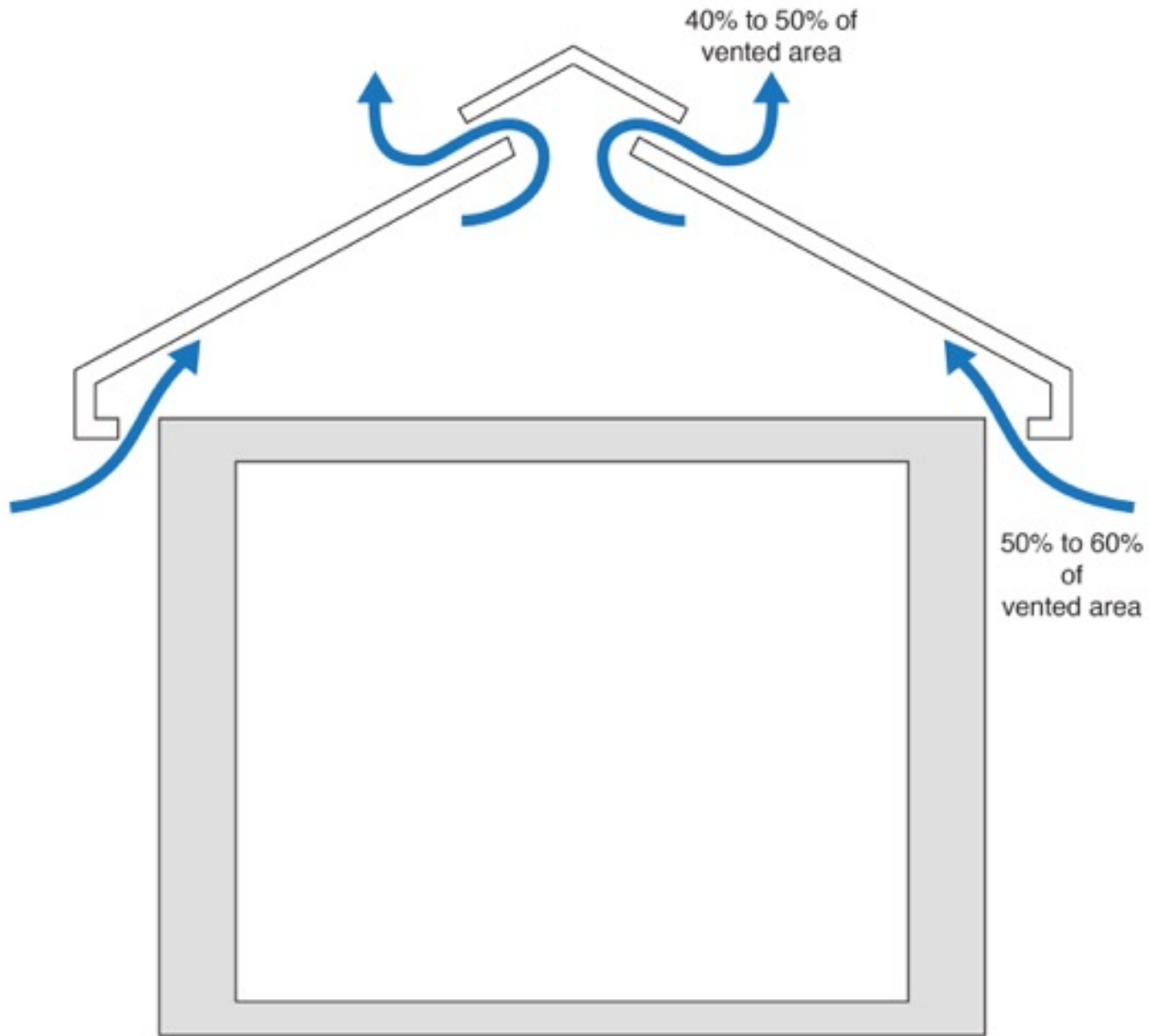

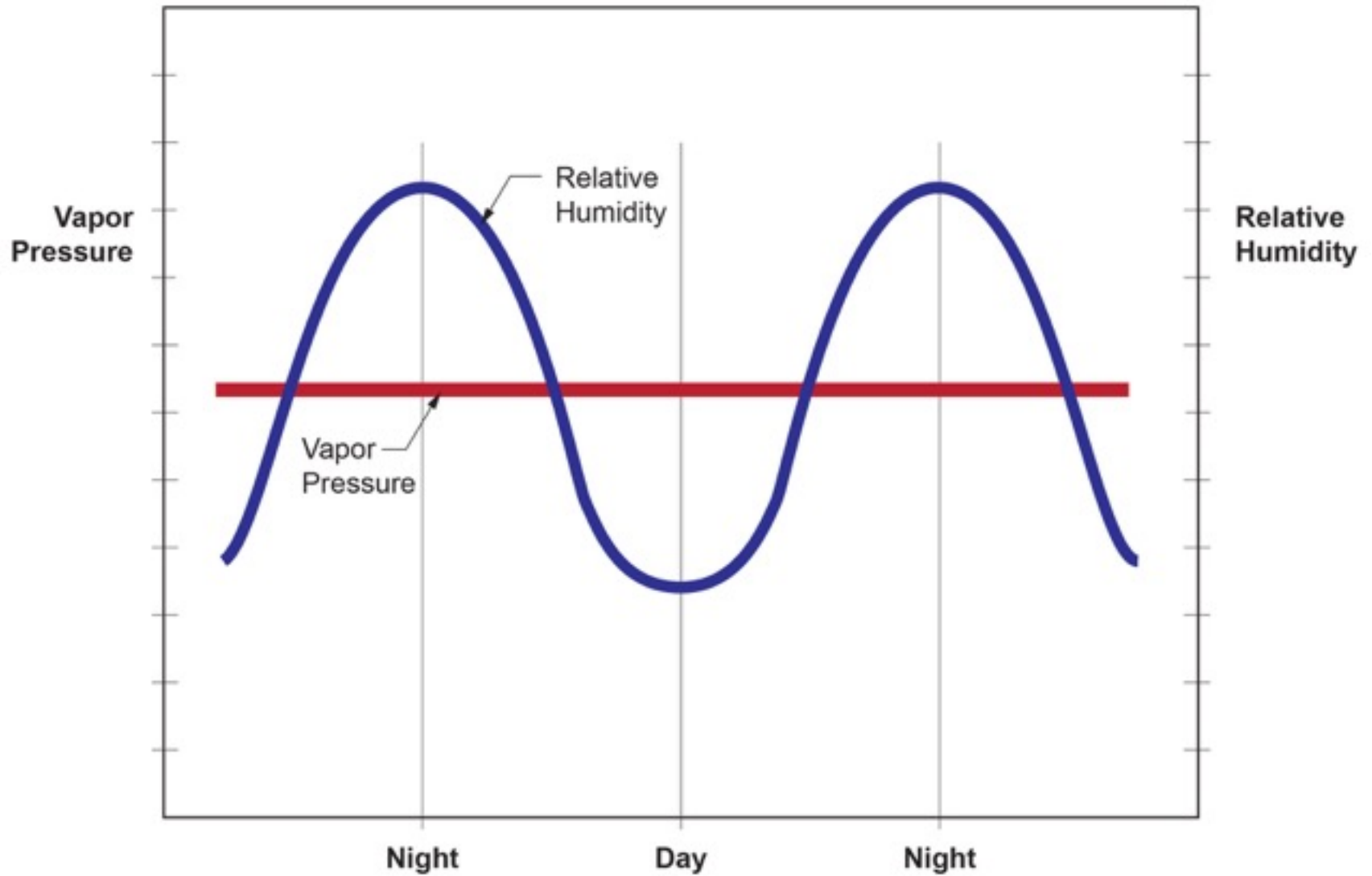

Houses With Vented Attics Suck

Houses With Vented Attics Suck
Not all the Time.....but.....





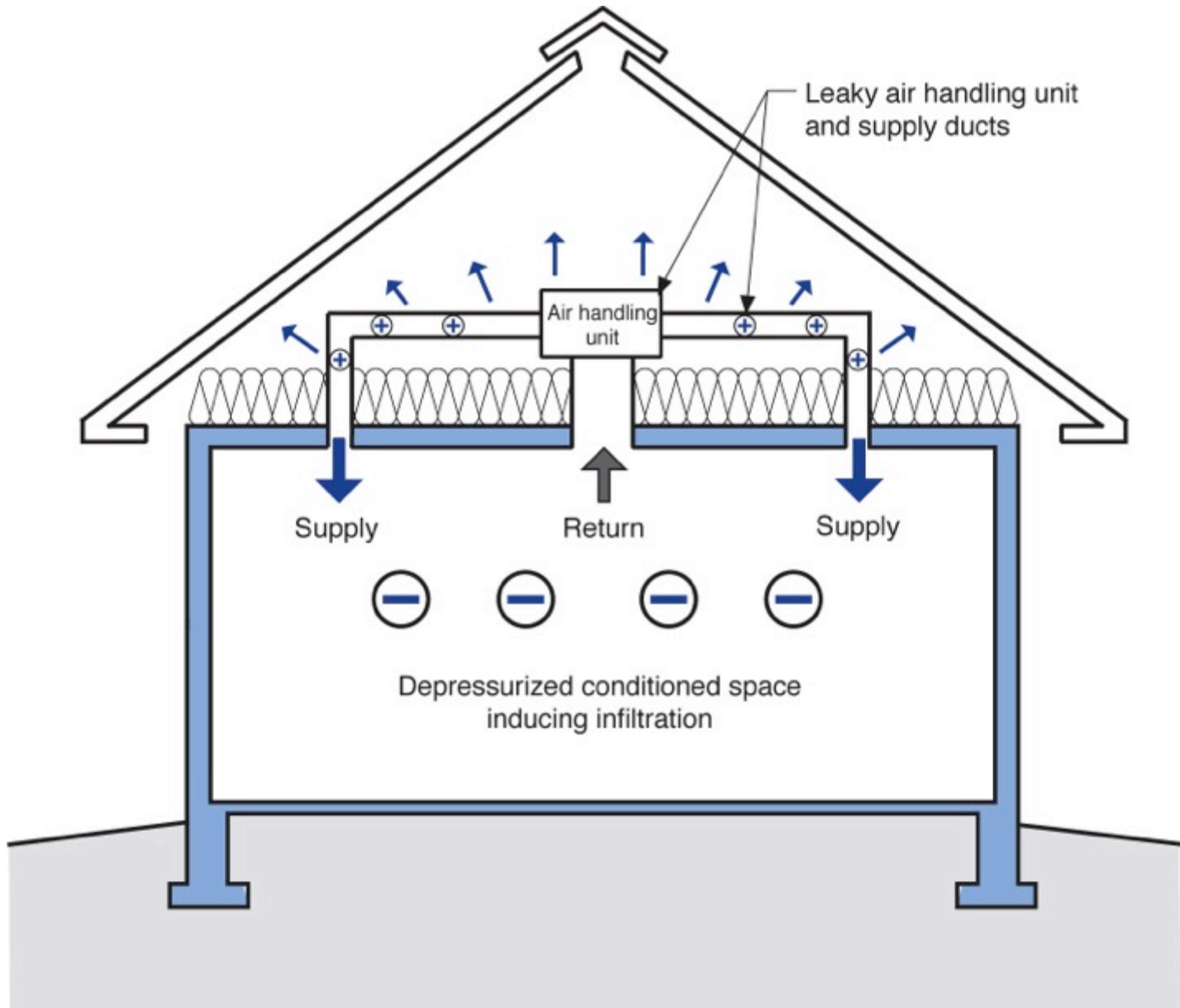

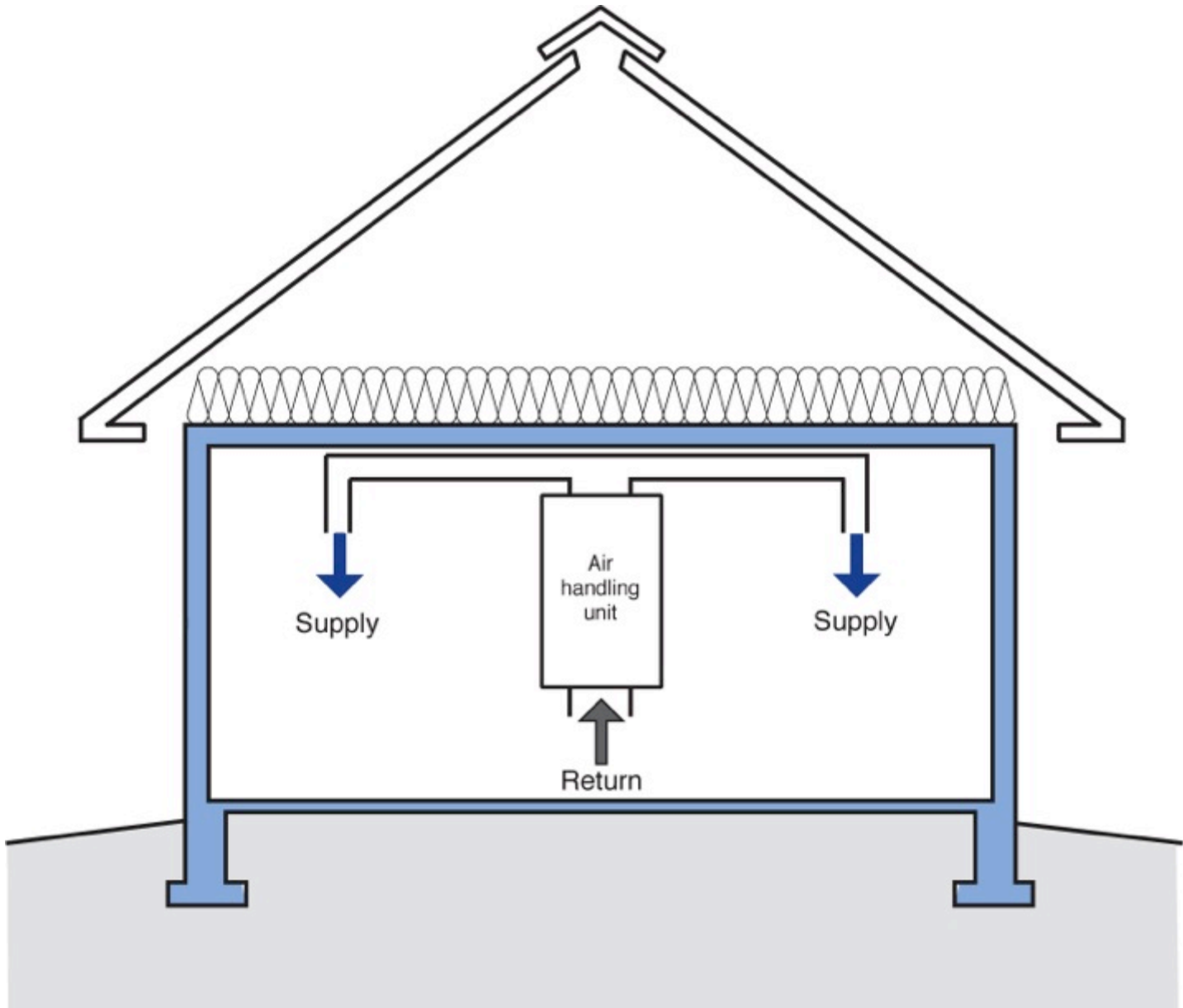

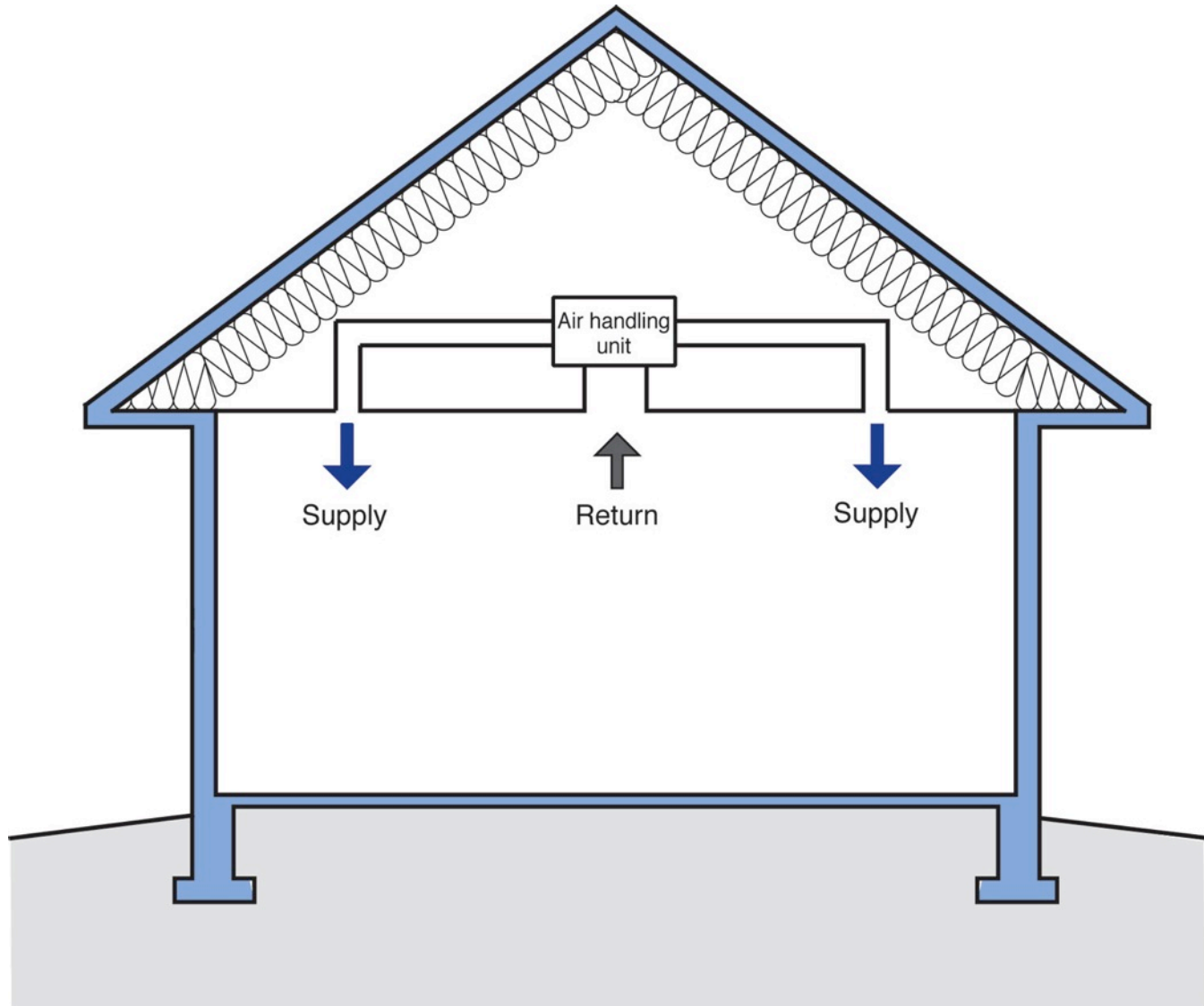







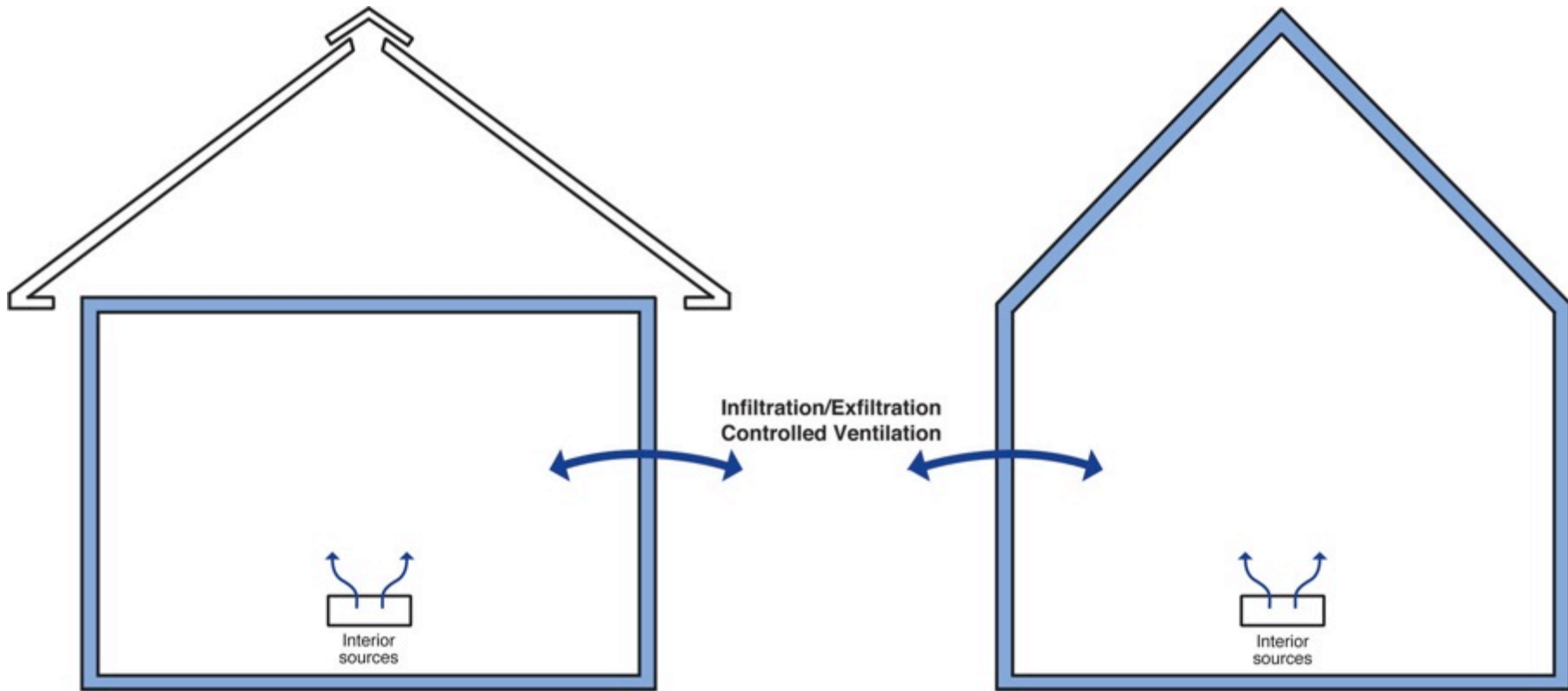

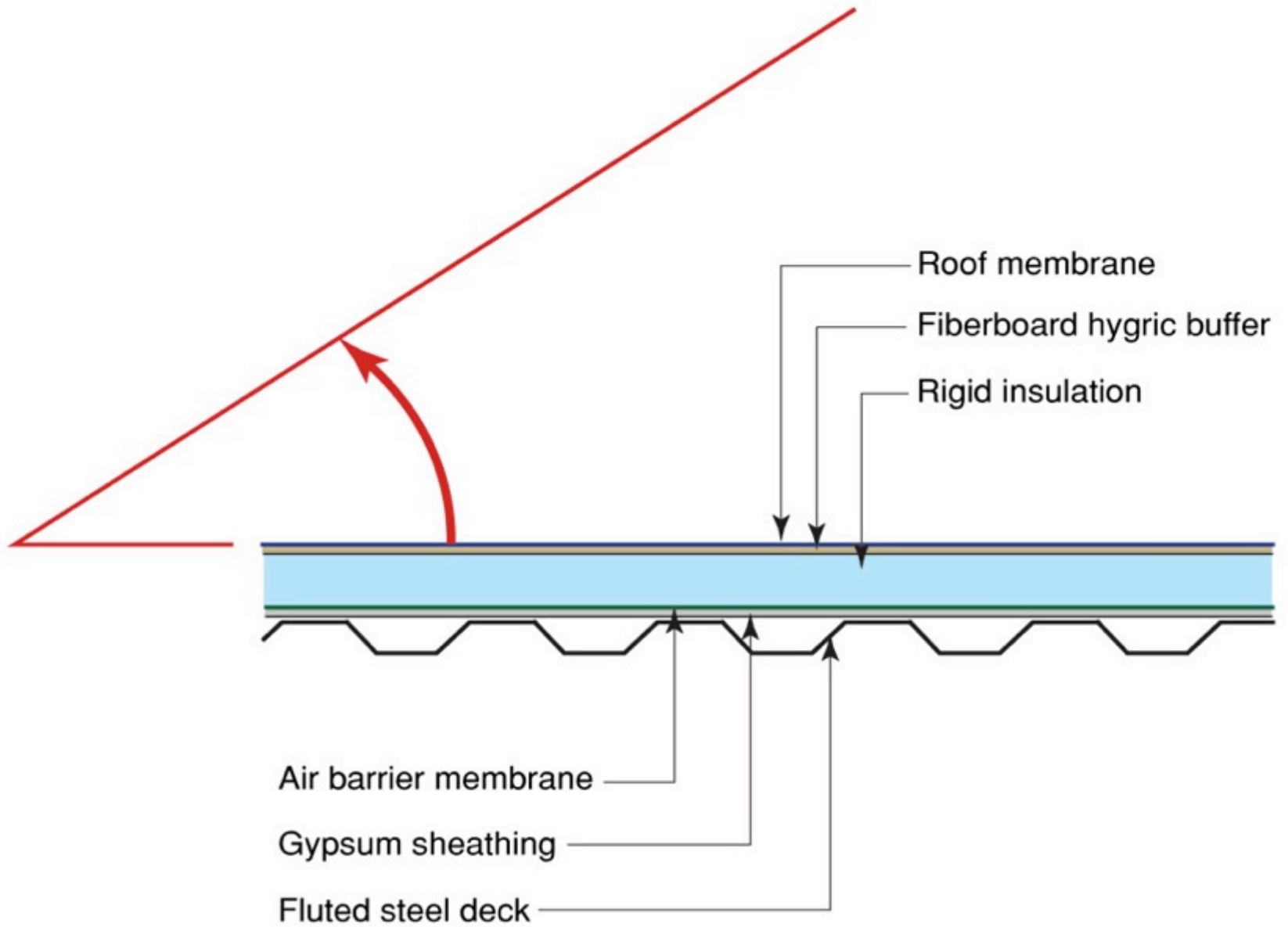

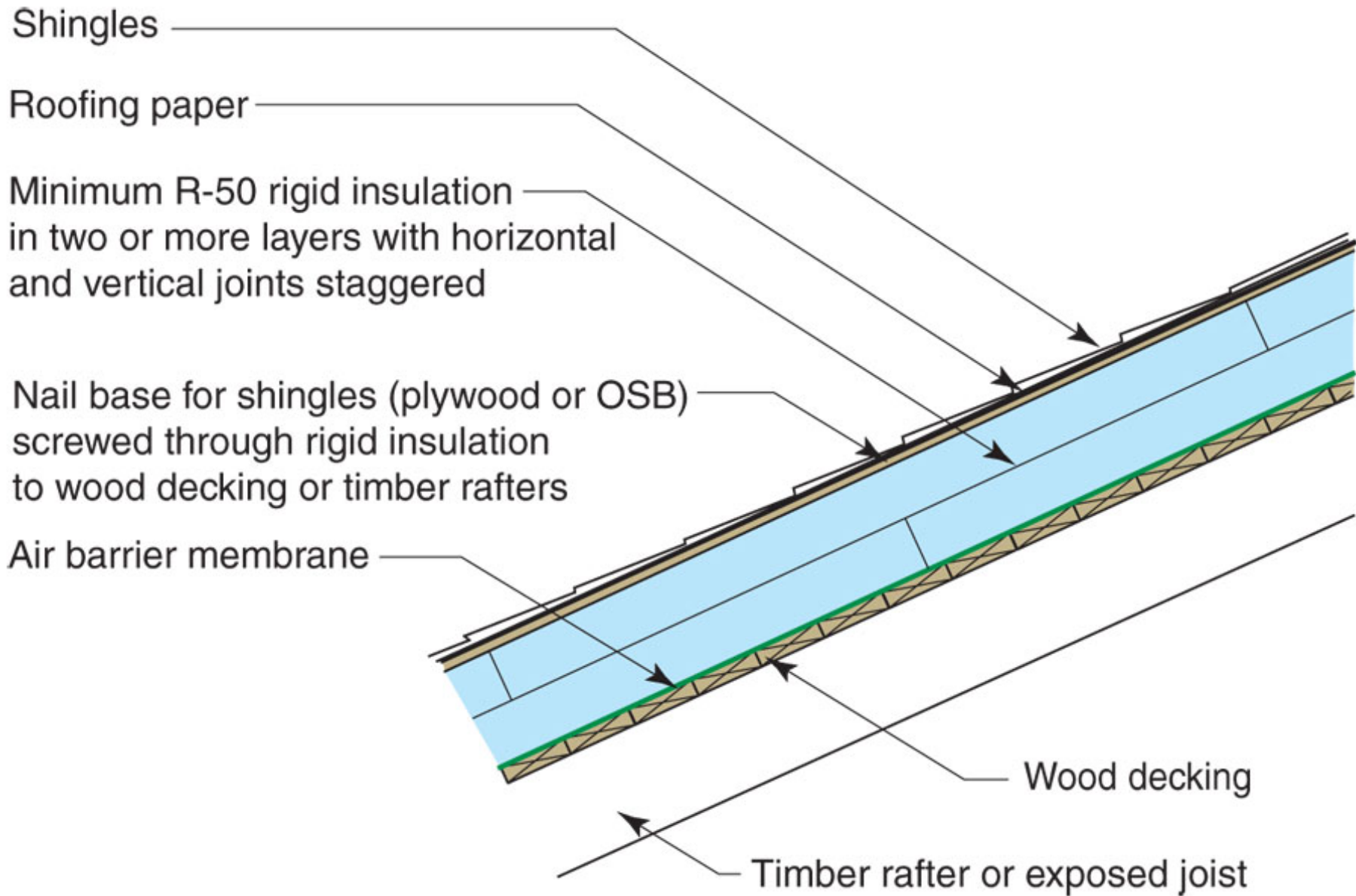











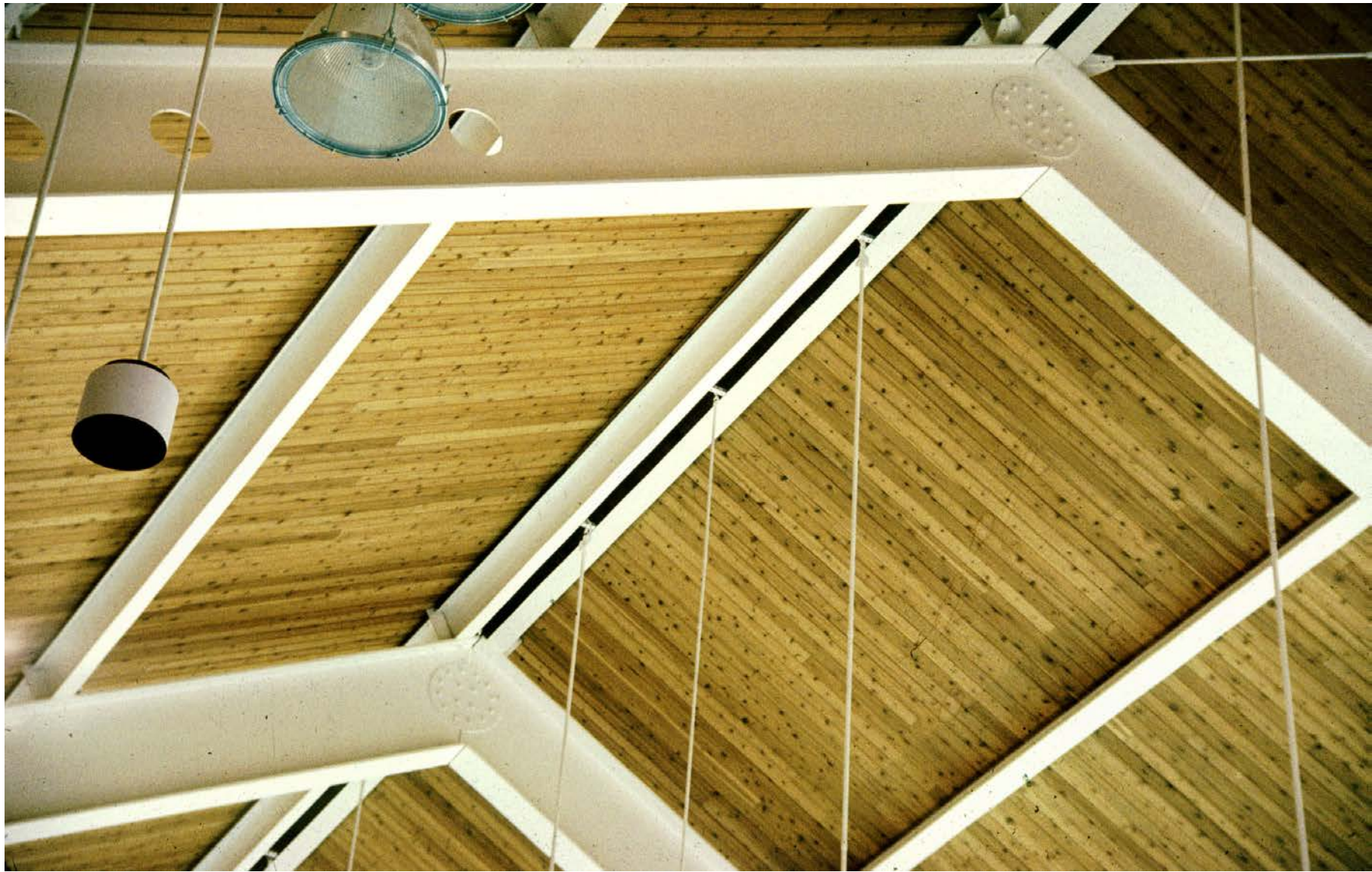













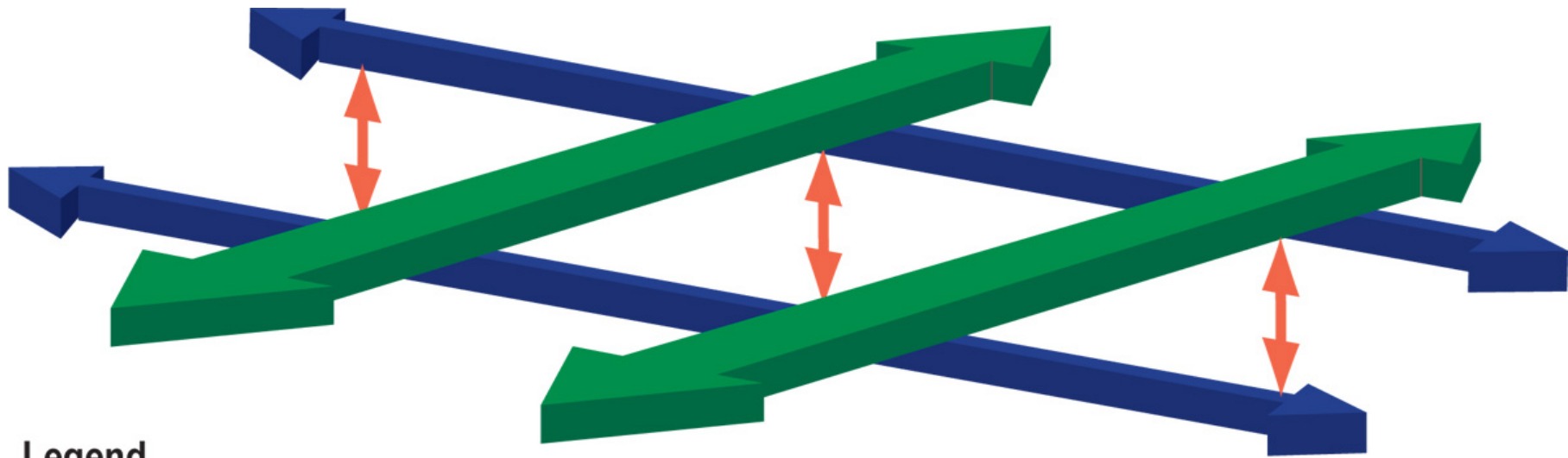

Legend

- ↔ Upper level air flows
- ↔ Lower level air flows
- ↕ Air flow at panel joints

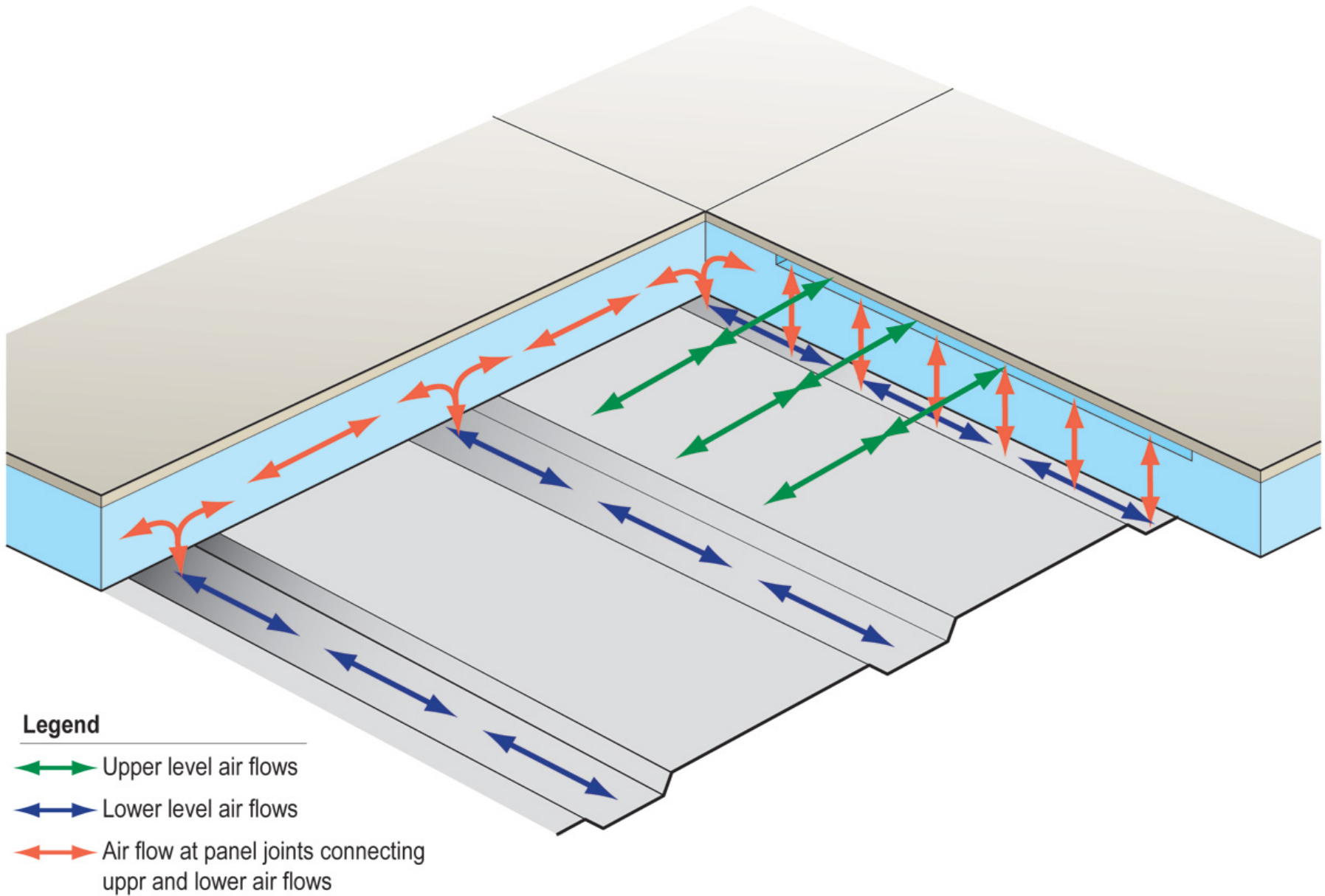

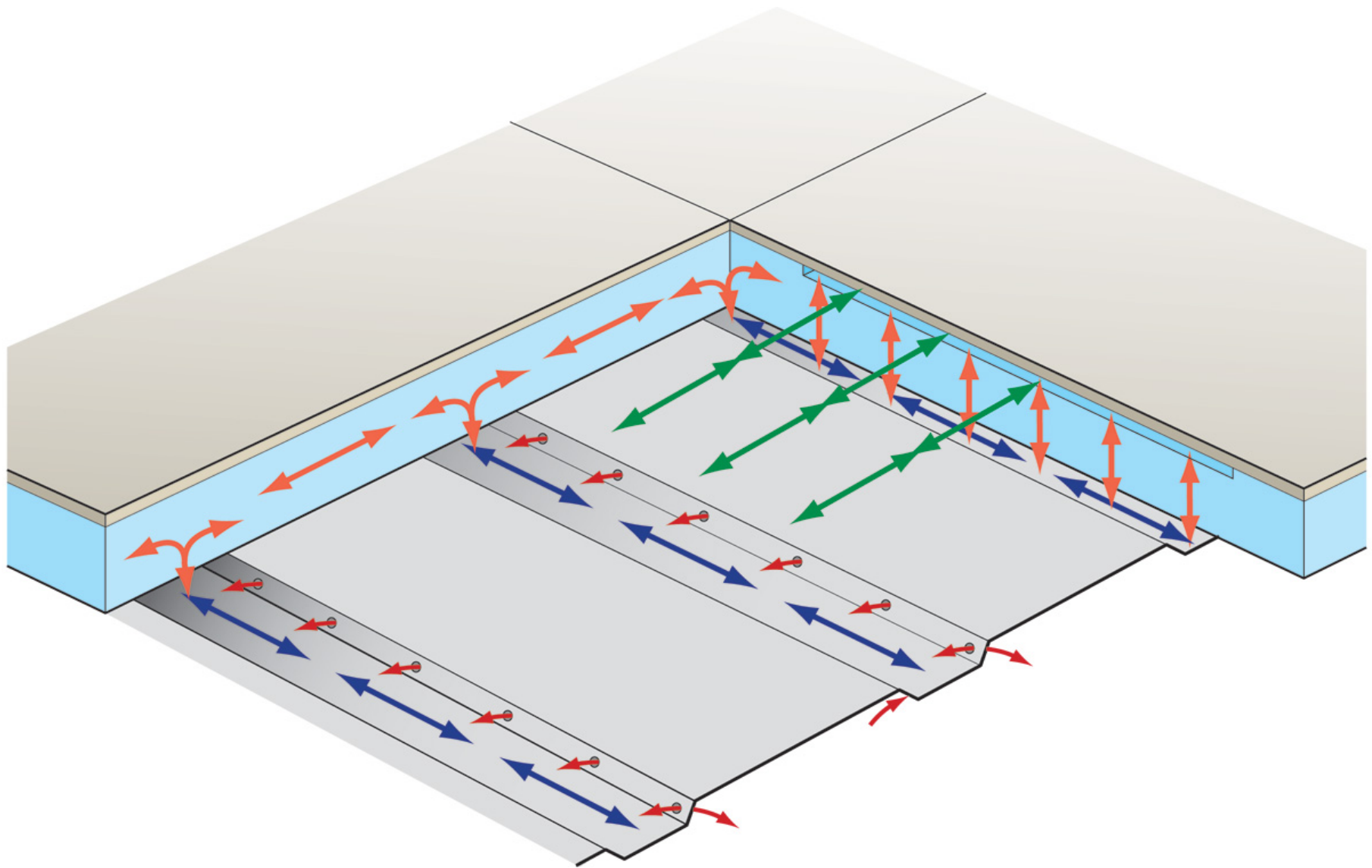



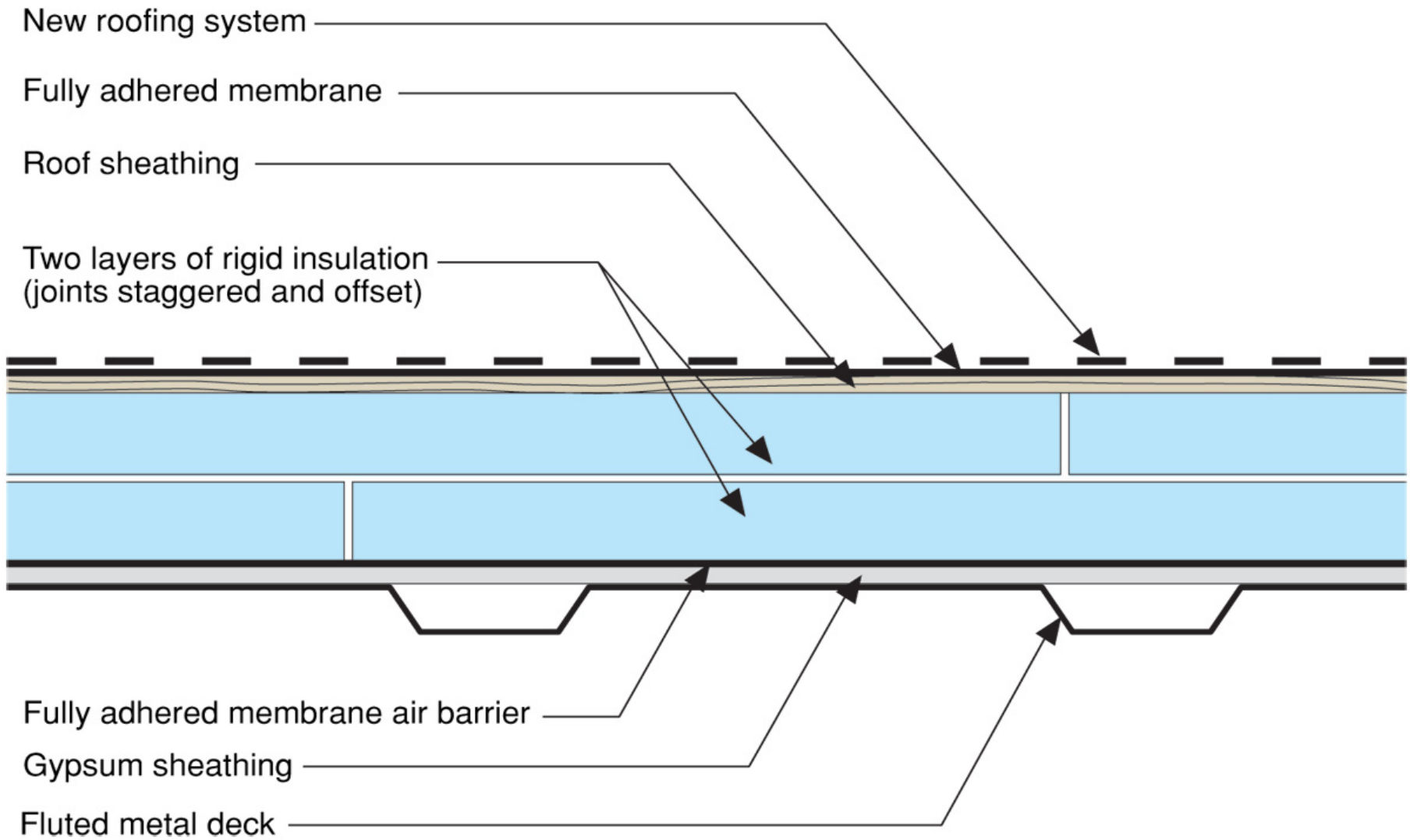









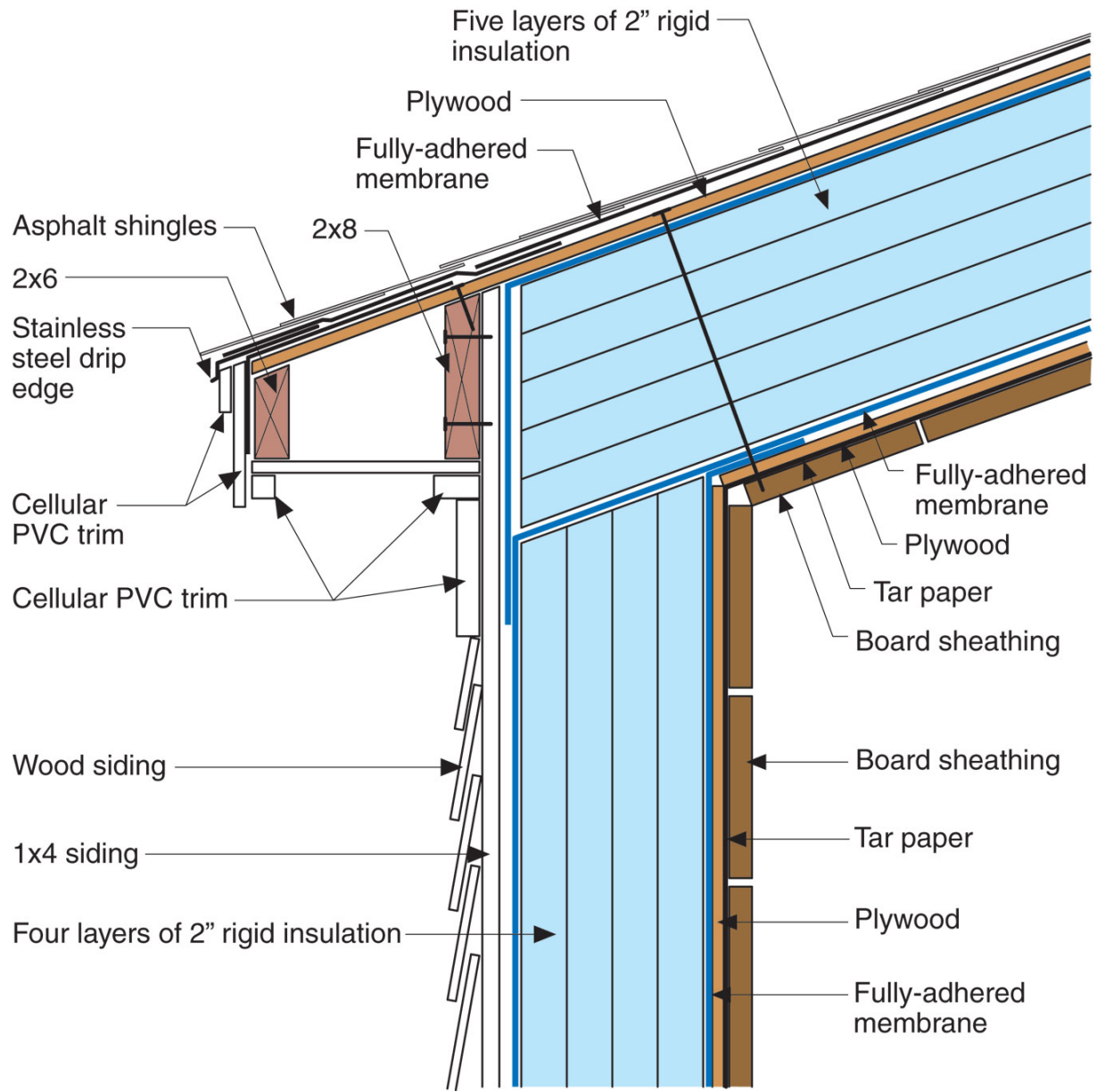





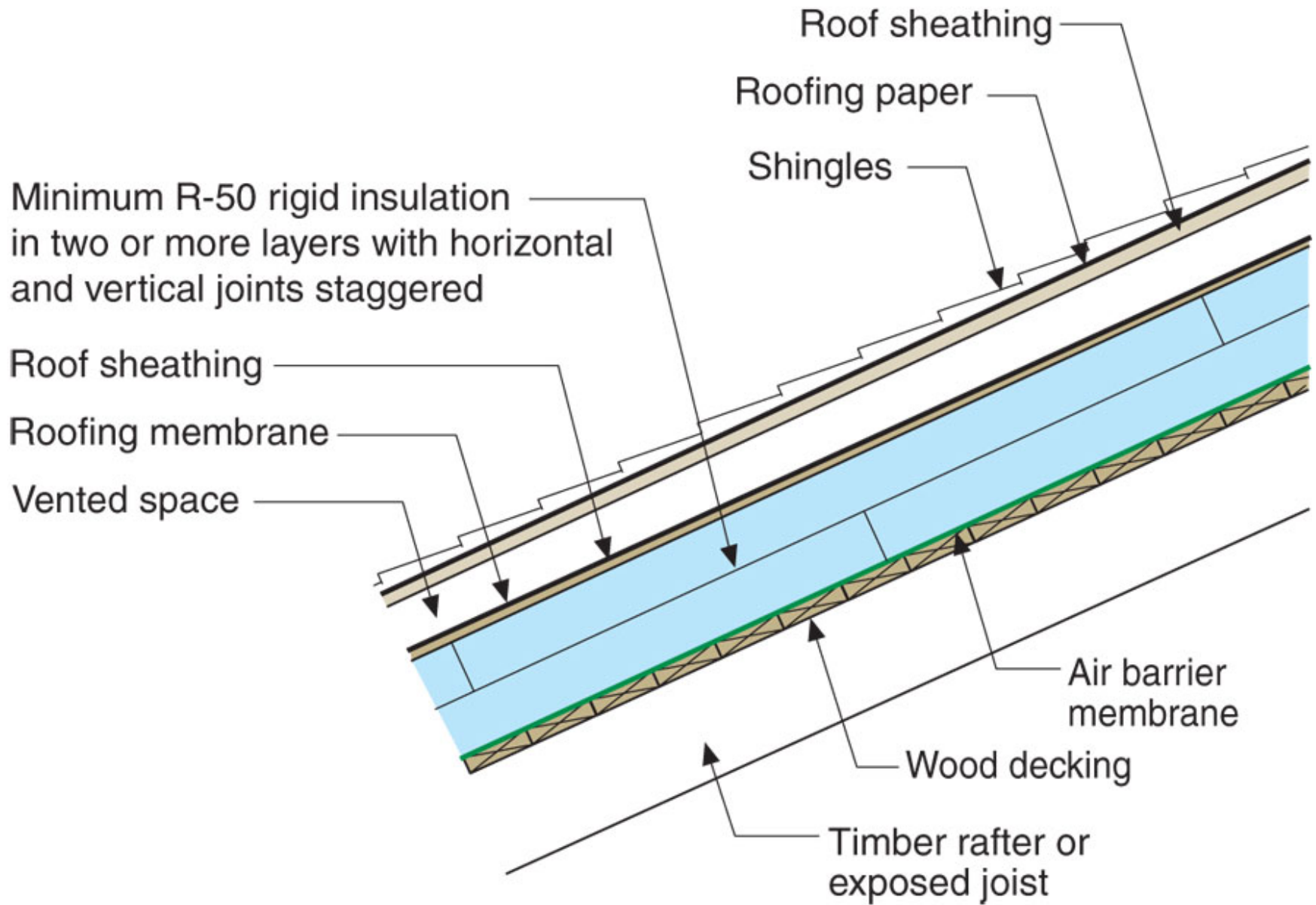





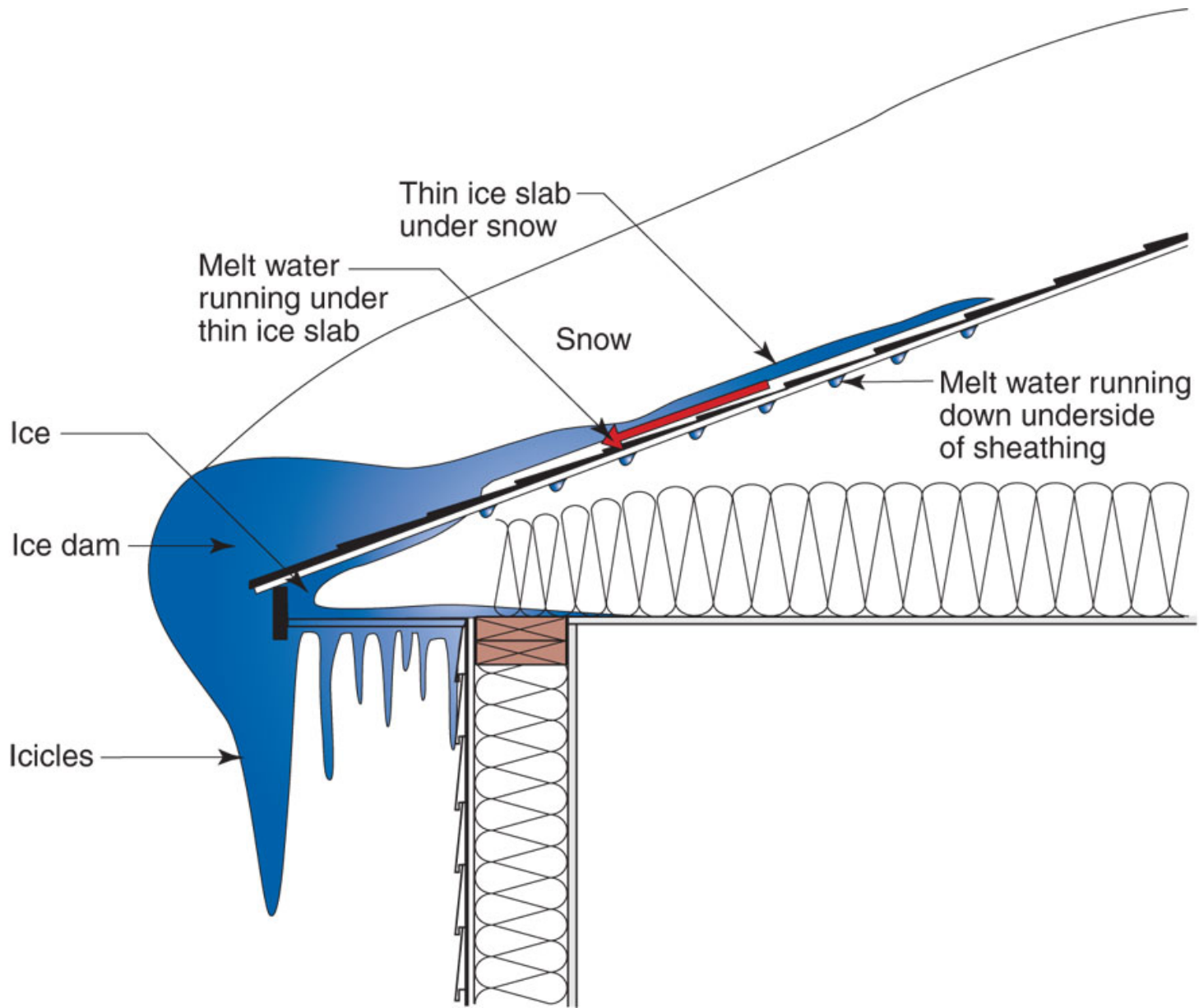









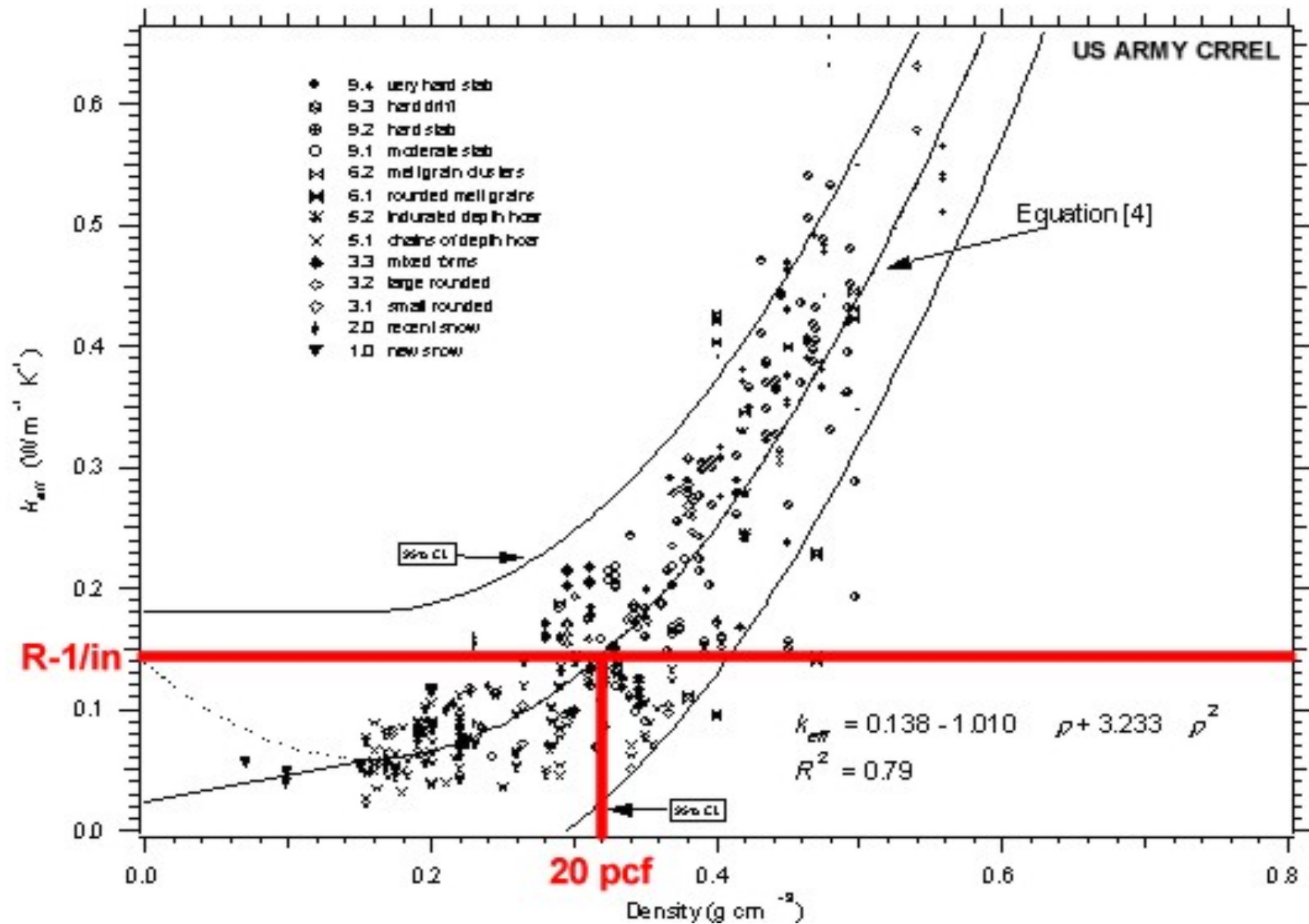





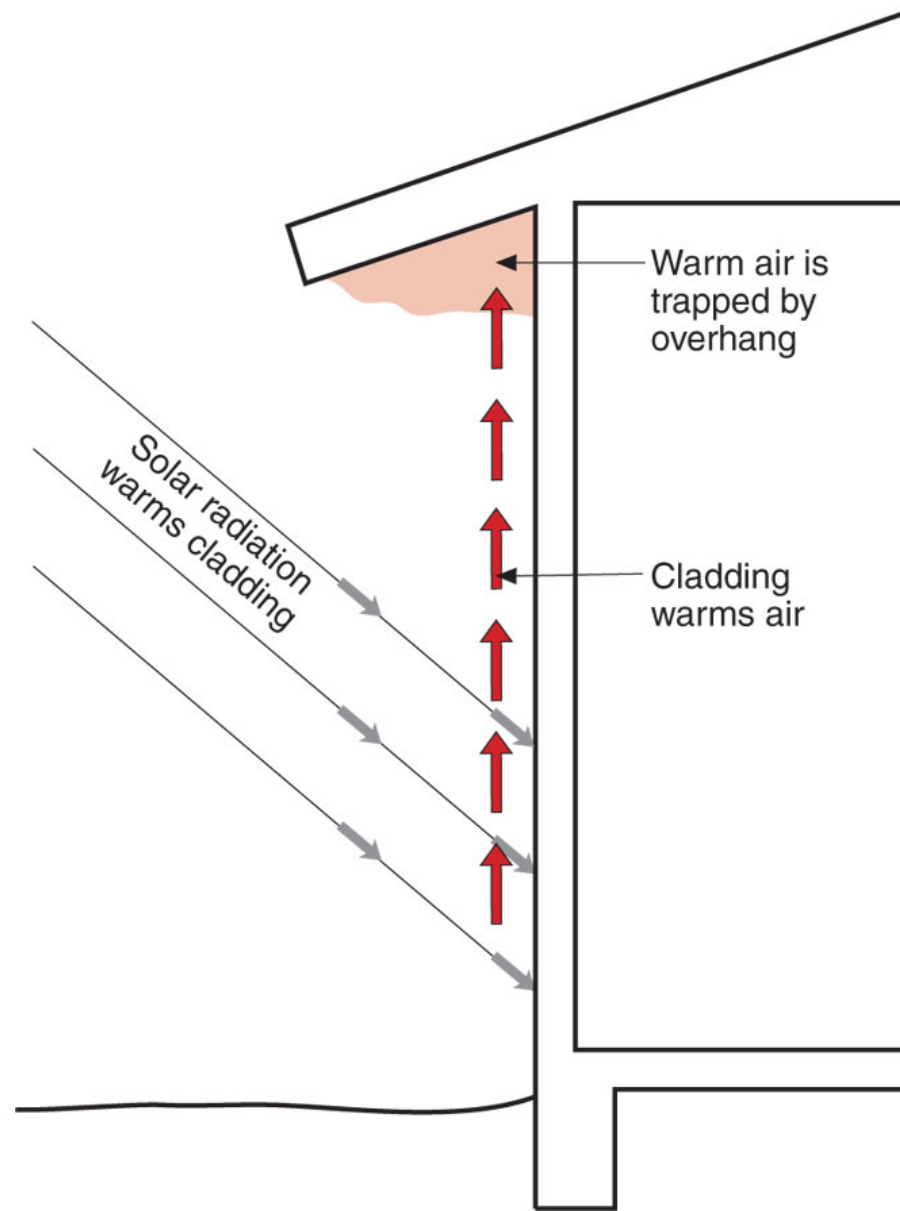









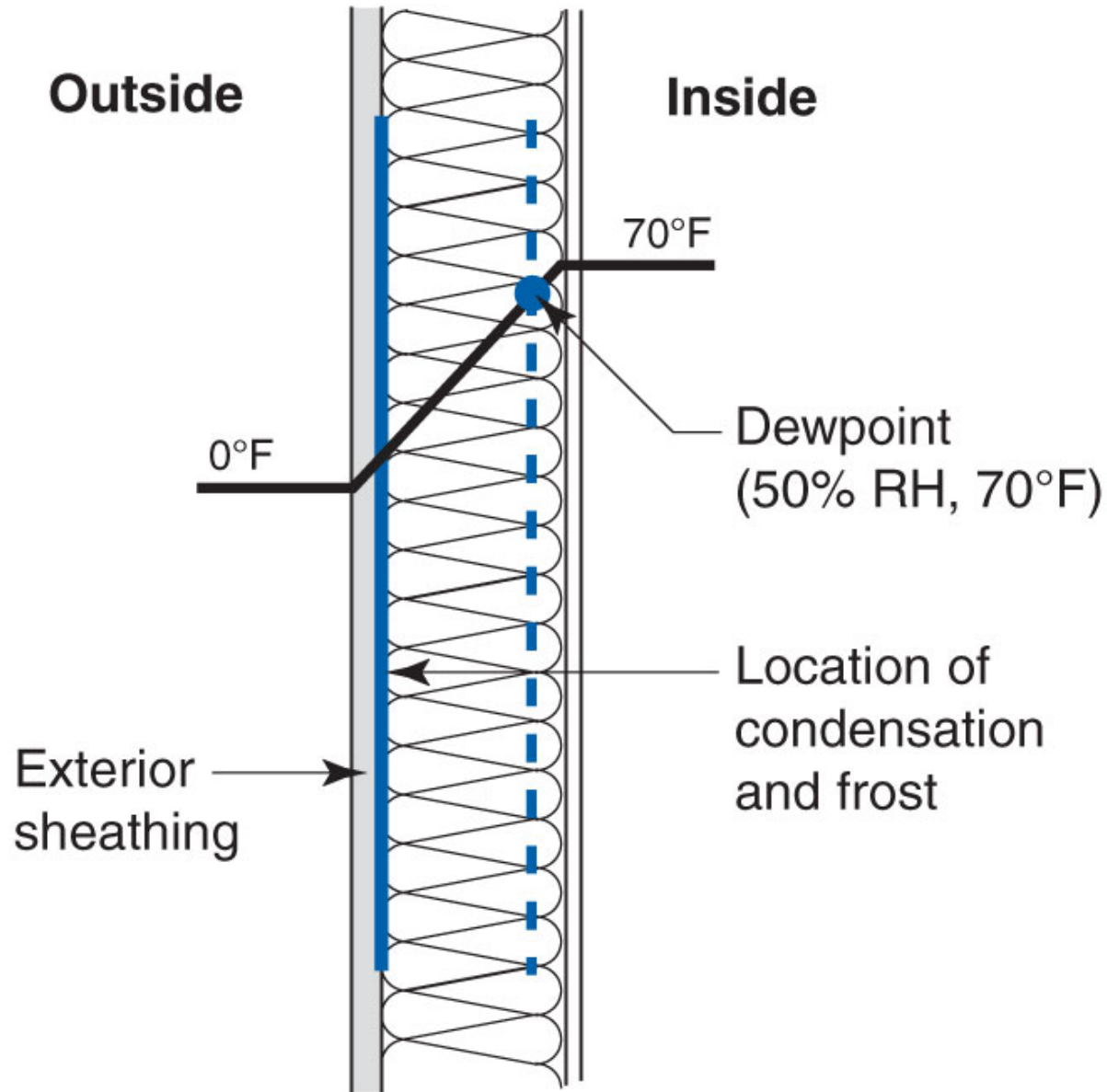



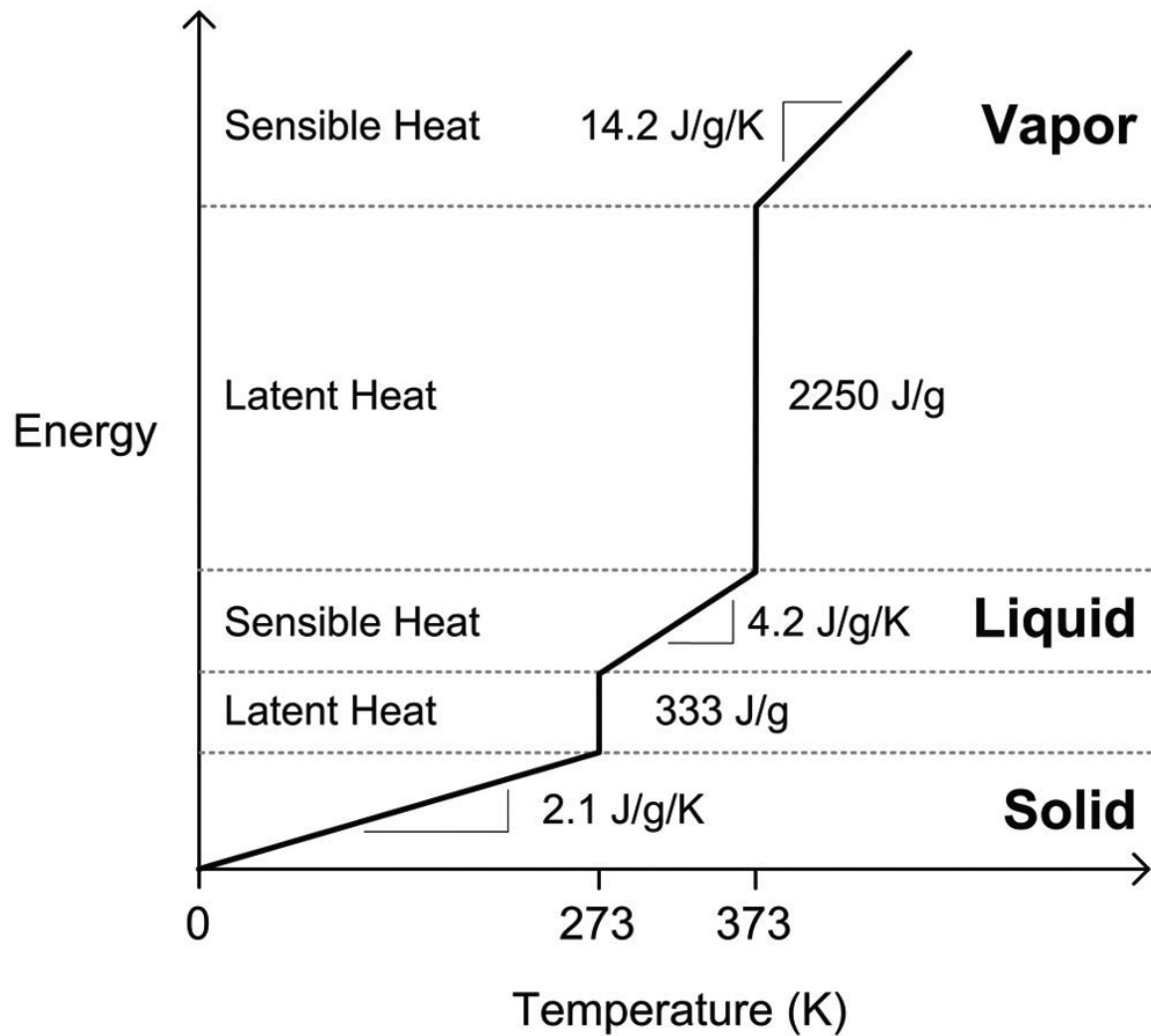

Simple linearized energy-temperature relation for water

From Straube & Burnett, 2005



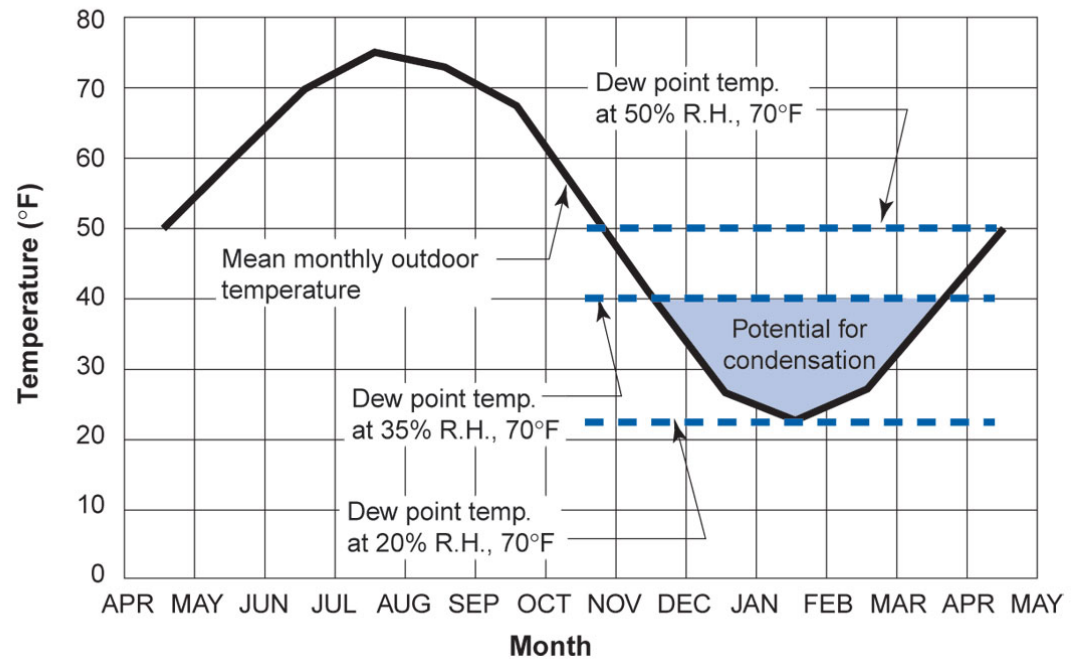
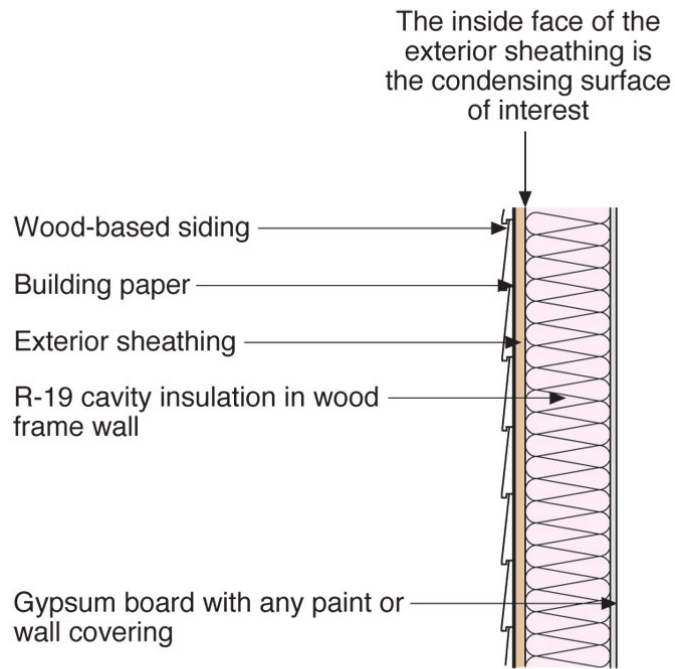

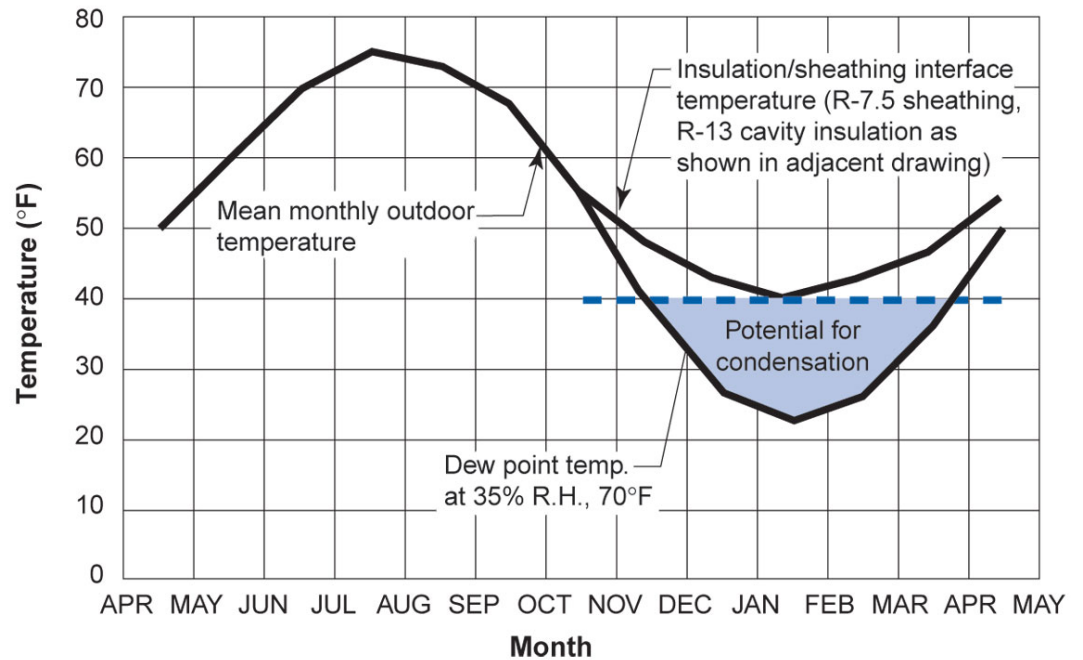
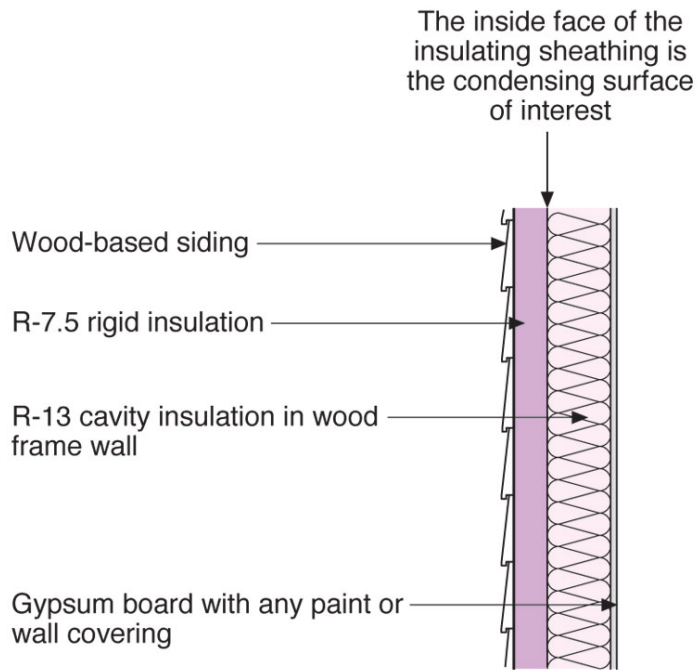

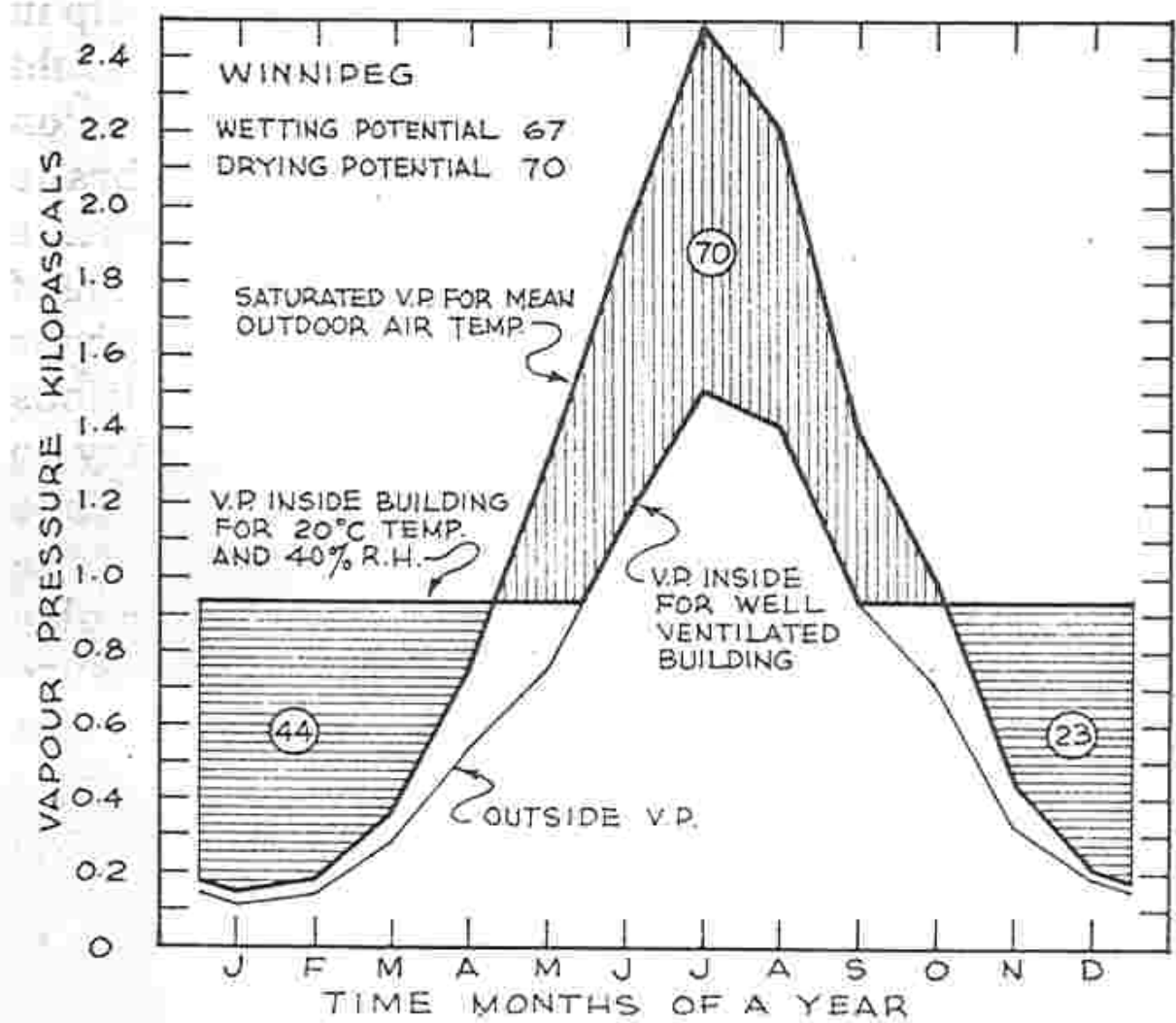
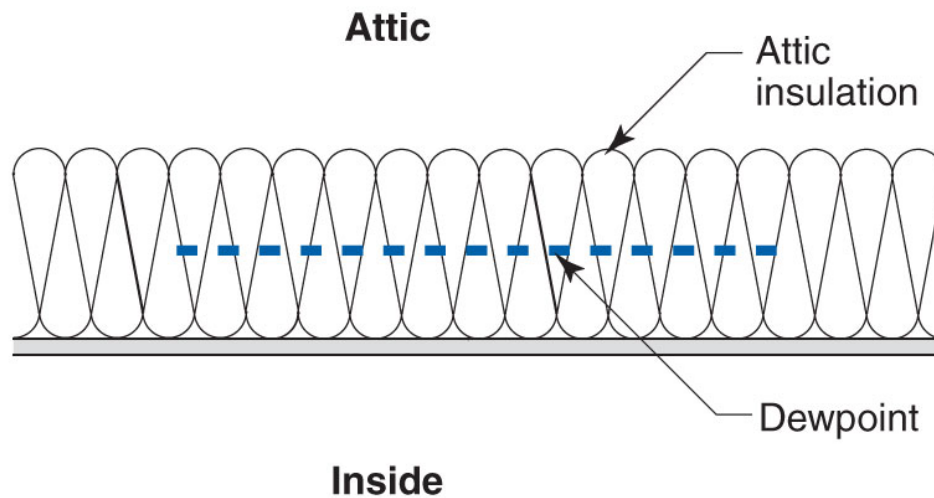
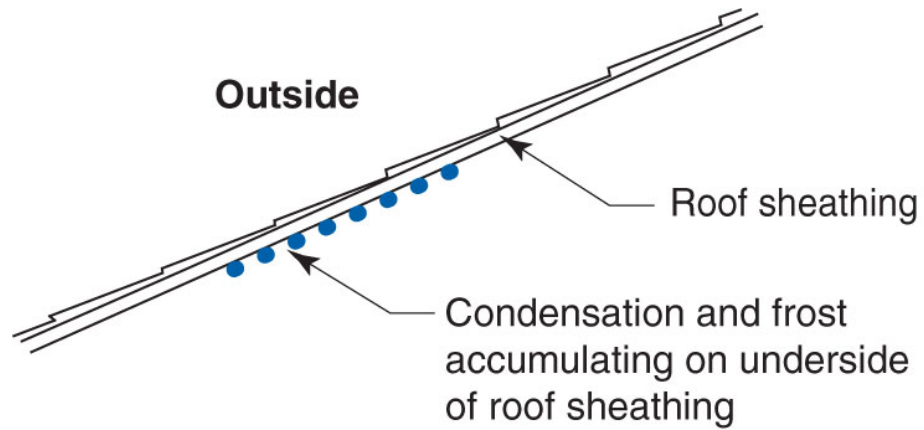
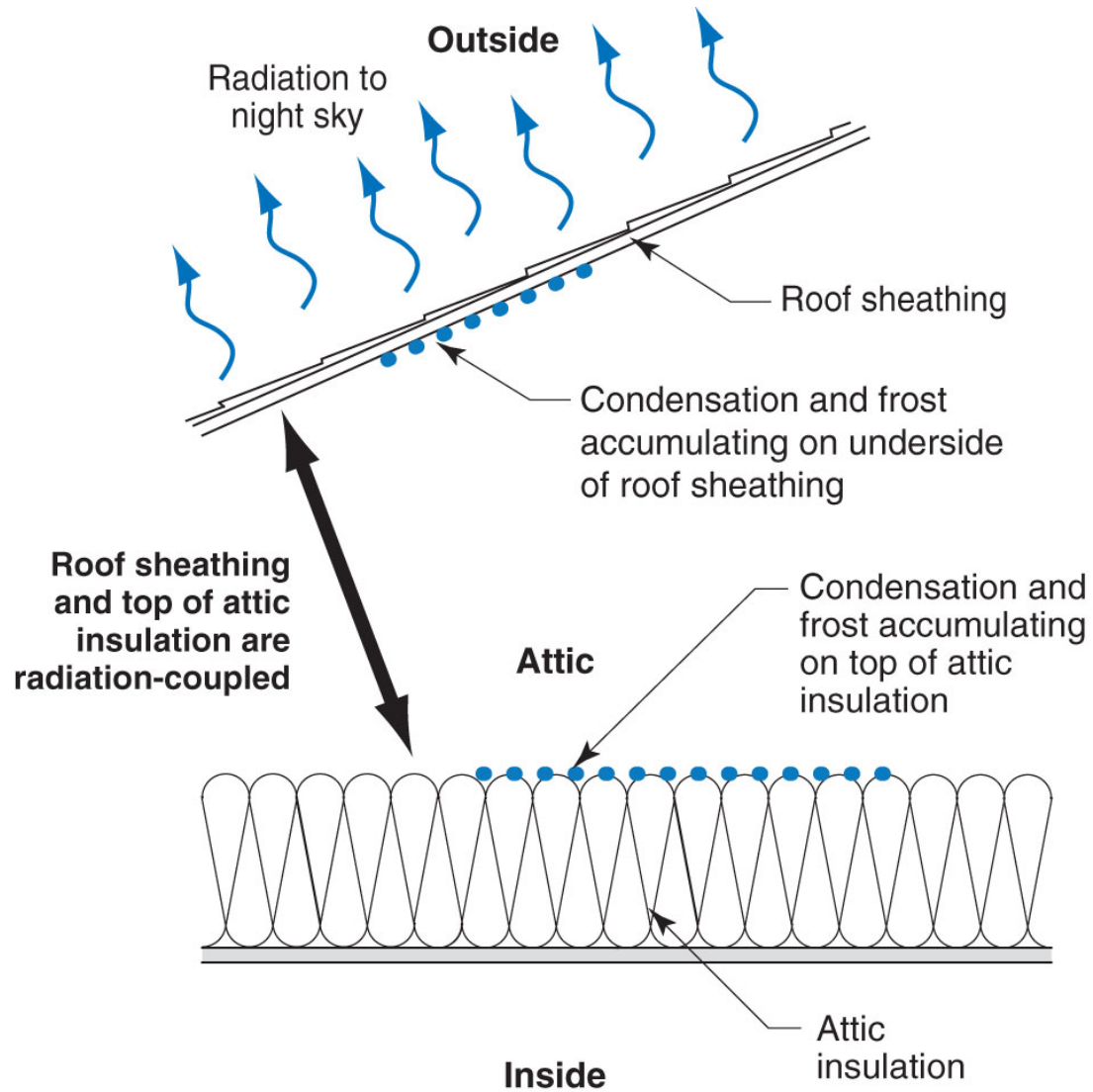
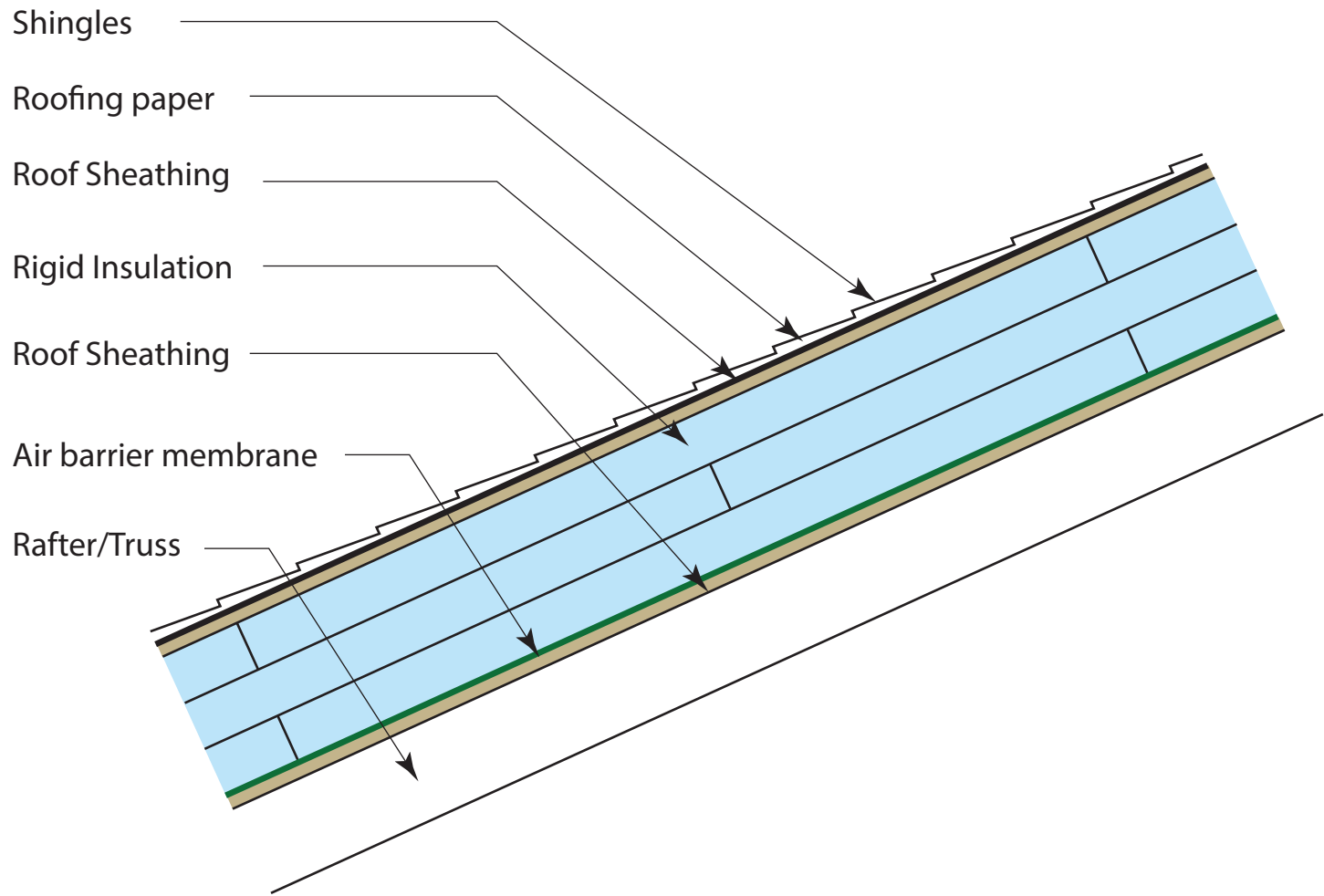

Figure 8-7. Outside vapour pressure, saturated vapour pressure and inside vapour pressure for Winnipeg.









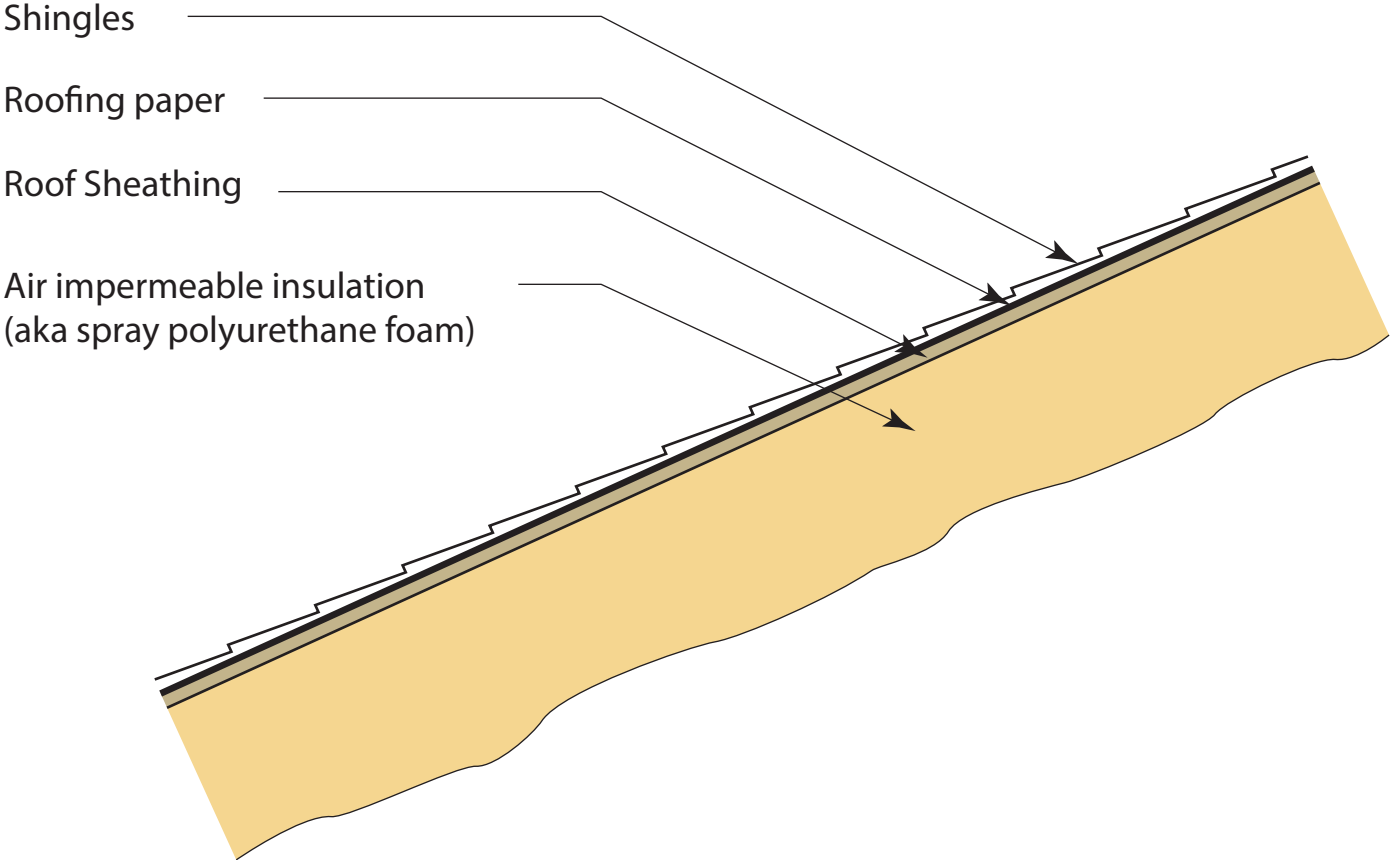

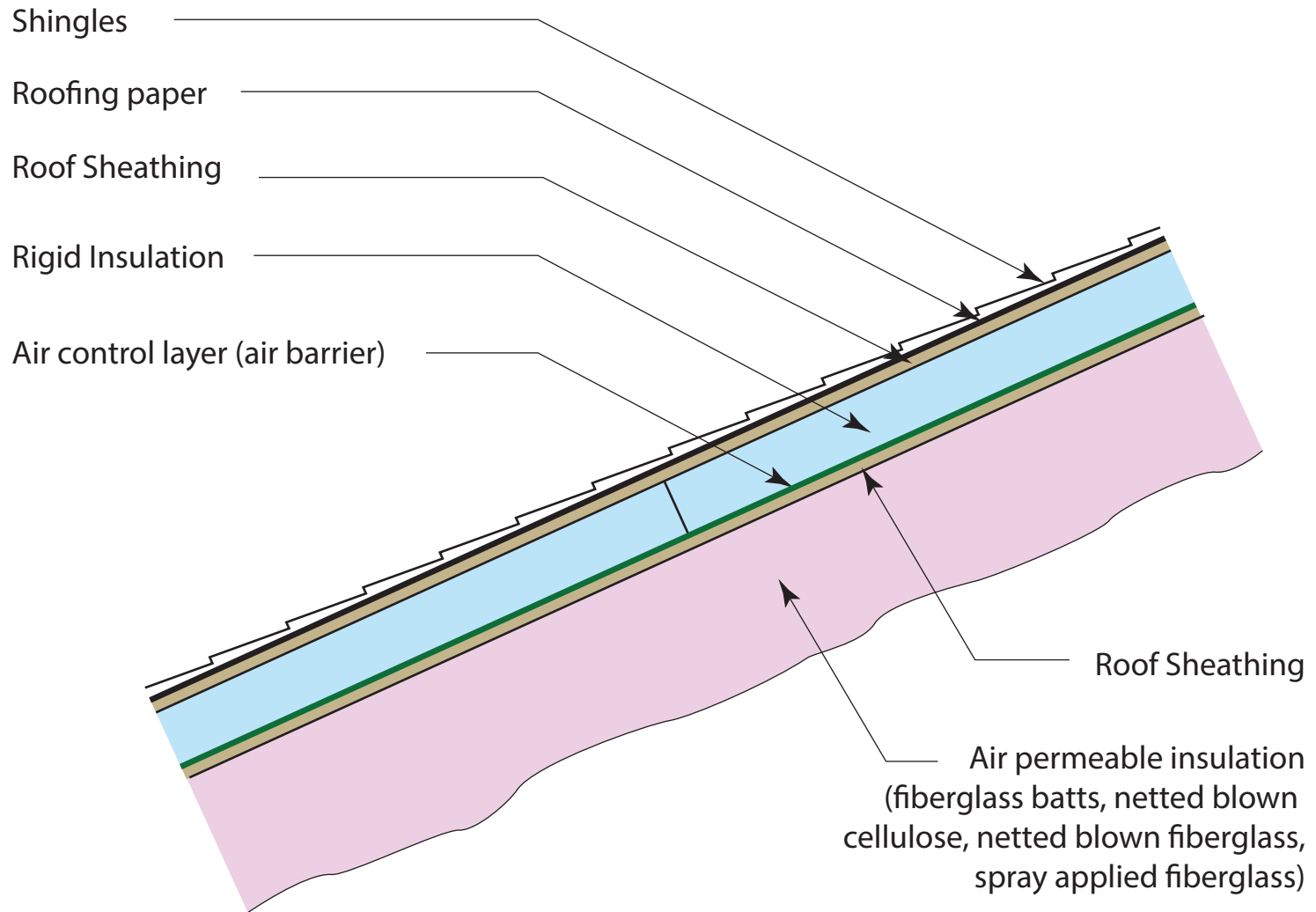

Shingles

Roofing paper

Roof Sheathing

Air impermeable insulation
(aka spray polyurethane foam)

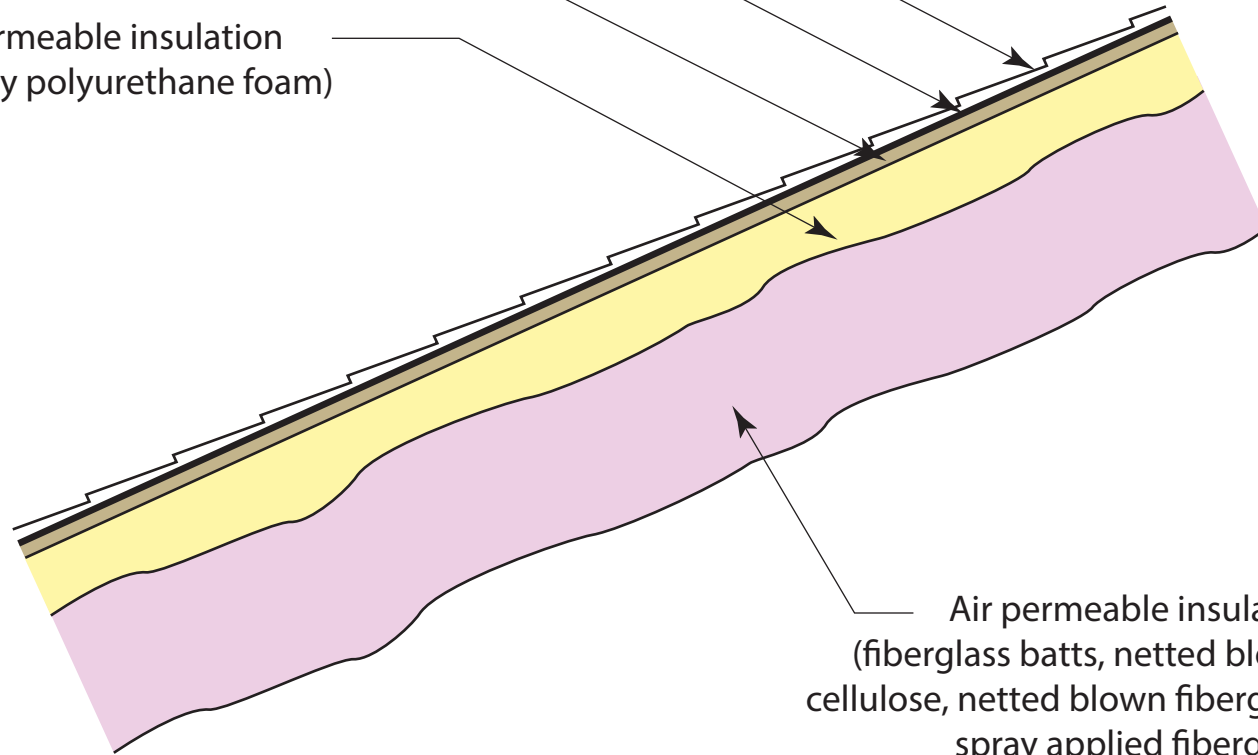

Air permeable insulation
(fiberglass batts, netted blown
cellulose, netted blown fiberglass,
spray applied fiberglass)

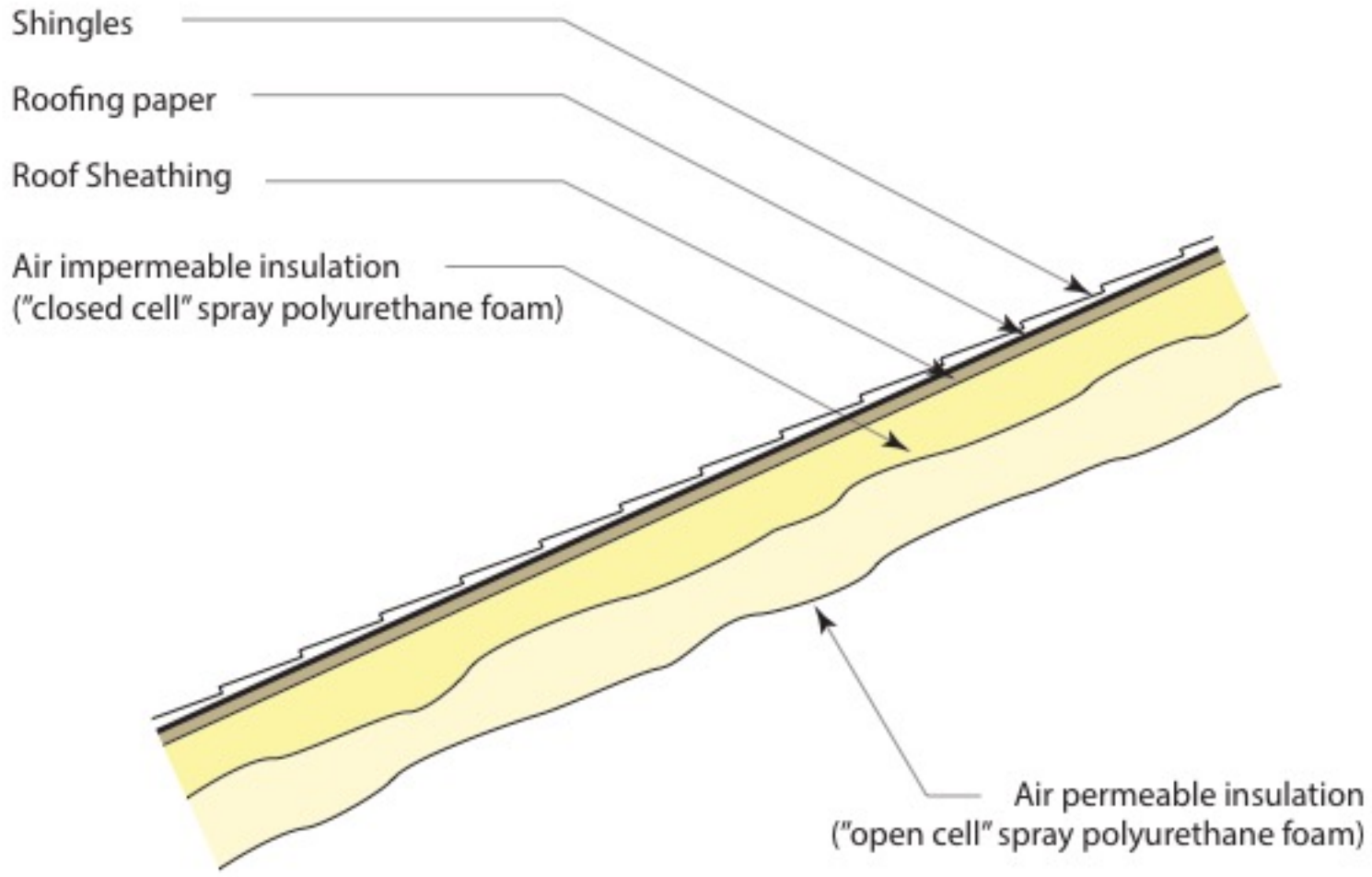

Insulation for Condensation Control*

Climate Zone	Rigid Board or Air Impermeable Insulation	Total Cavity Insulation	Total Wall Assembly Insulation	Ratio of Rigid Board Insulation or Air Impermeable R-Value to Total Insulation R-Value
4C	R-2.5	R-13	R-15.5	15%
	R-3.75	R-20	R-23.75	15%
5	R-5	R-13	R-18	30%
	R-7.5	R-20	R-27.5	30%
6	R-7.5	R-13	R-20.5	35%
	R-11.25	R-20	R-31.25	35%
7	R-10	R-13	R-28	45%
	R-15	R-20	R-35	45%
8	R-15	R-13	R-28	50%
	R-20	R-20	R-40	50%

*Adapted from Table R 702.1 2015 International Residential Code

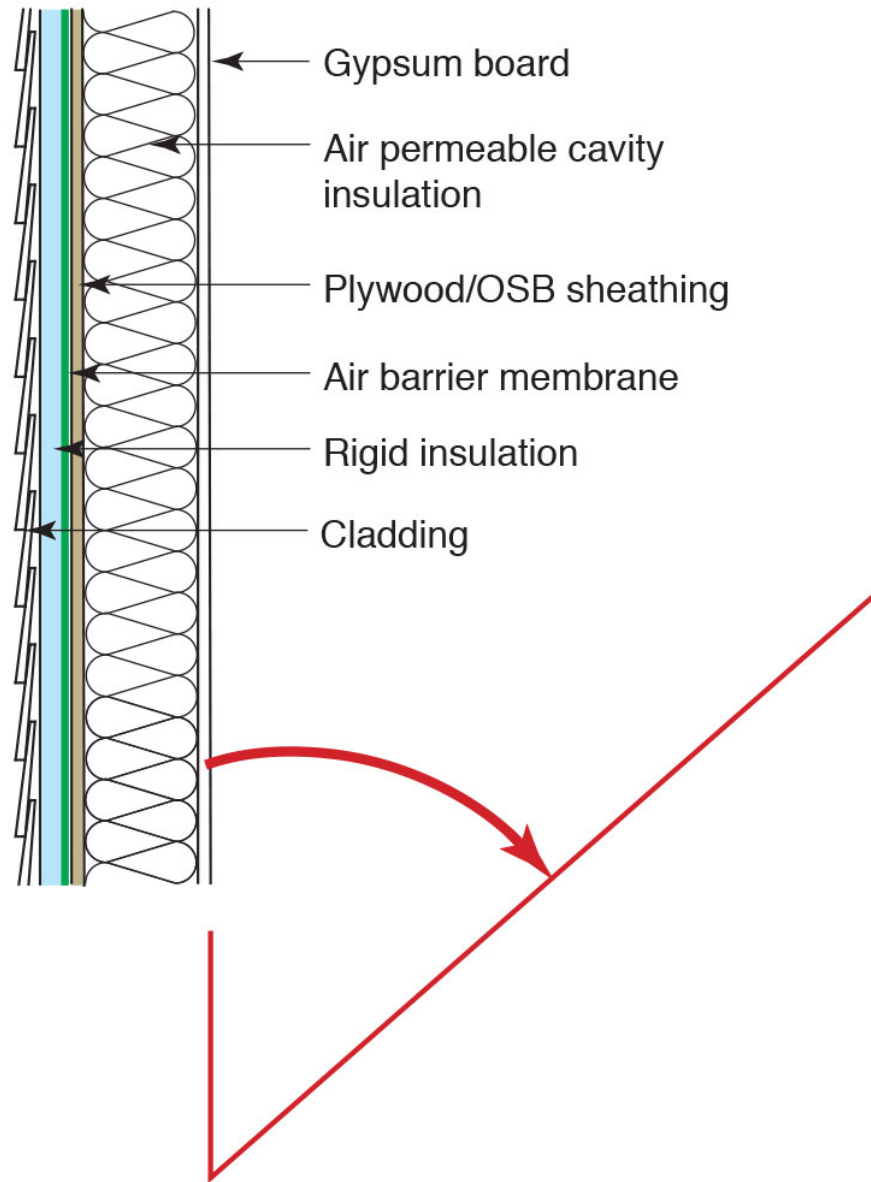

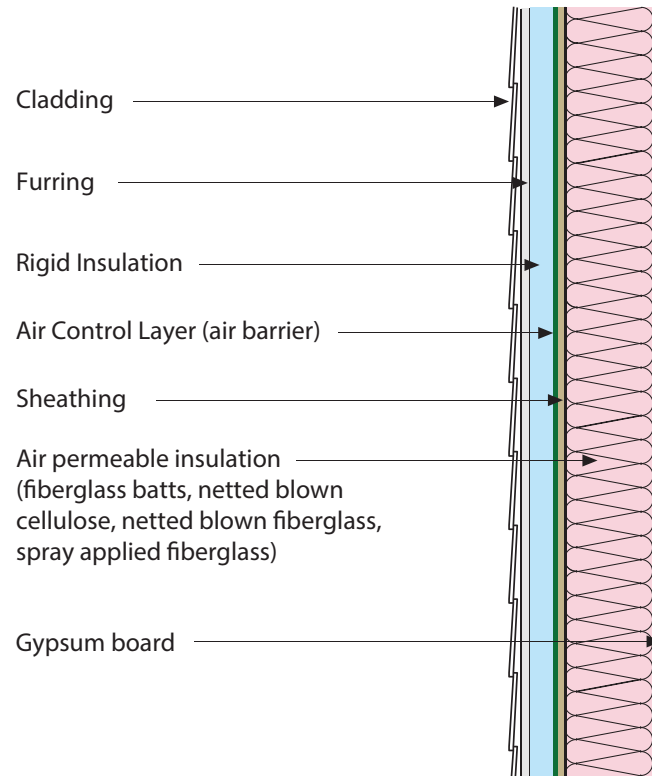

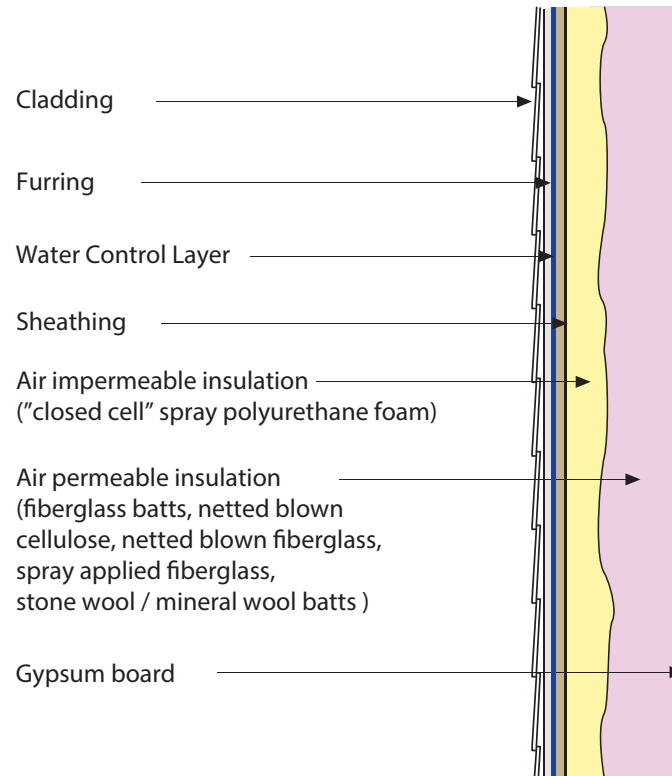

Insulation for Condensation Control*

Climate Zone	Rigid Board or Air Impermeable Insulation	Code Required R-Value	Ratio of Rigid Board Insulation or Air Impermeable R-Value to Total Insulation R-Value
1,2,3	R-5	R-38	10%
4C	R-10	R-49	20%
4A, 4B	R-15	R-49	30%
5	R-20	R-49	40%
6	R-25	R-49	50%
7	R-30	R-49	60%
8	R-35	R-49	70%

*Adapted from Table R 806.5 2015 International Residential Code

Table 1

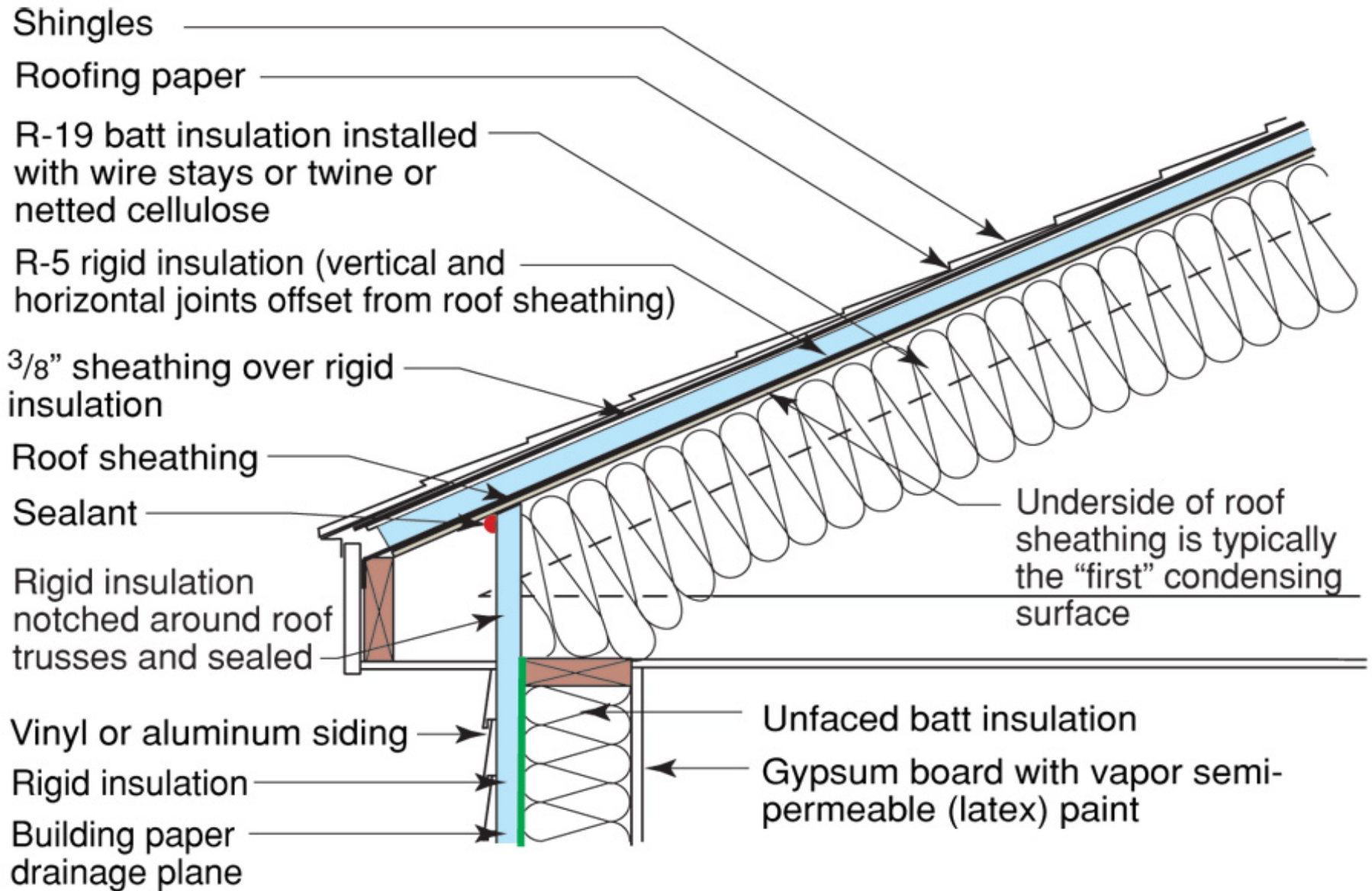

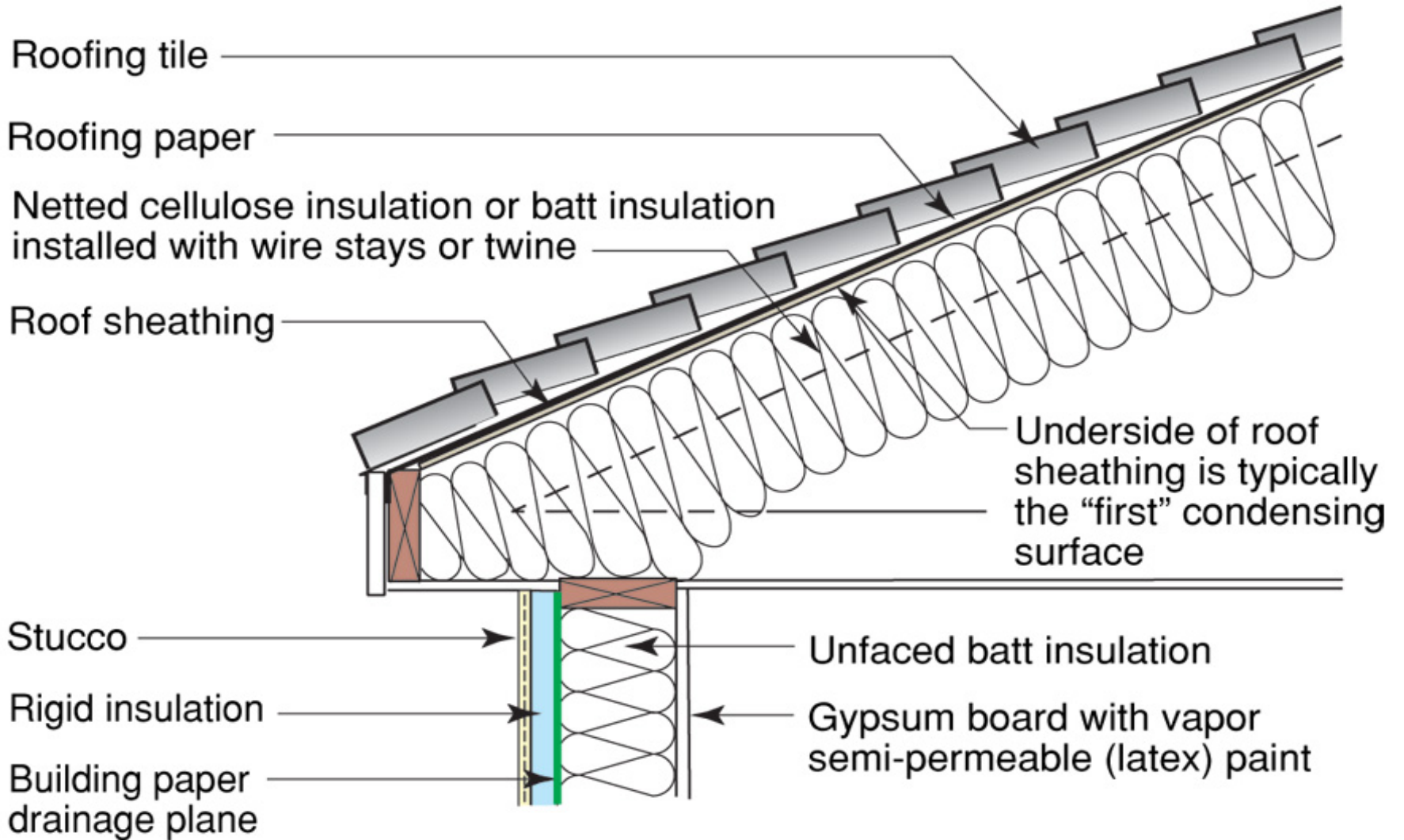







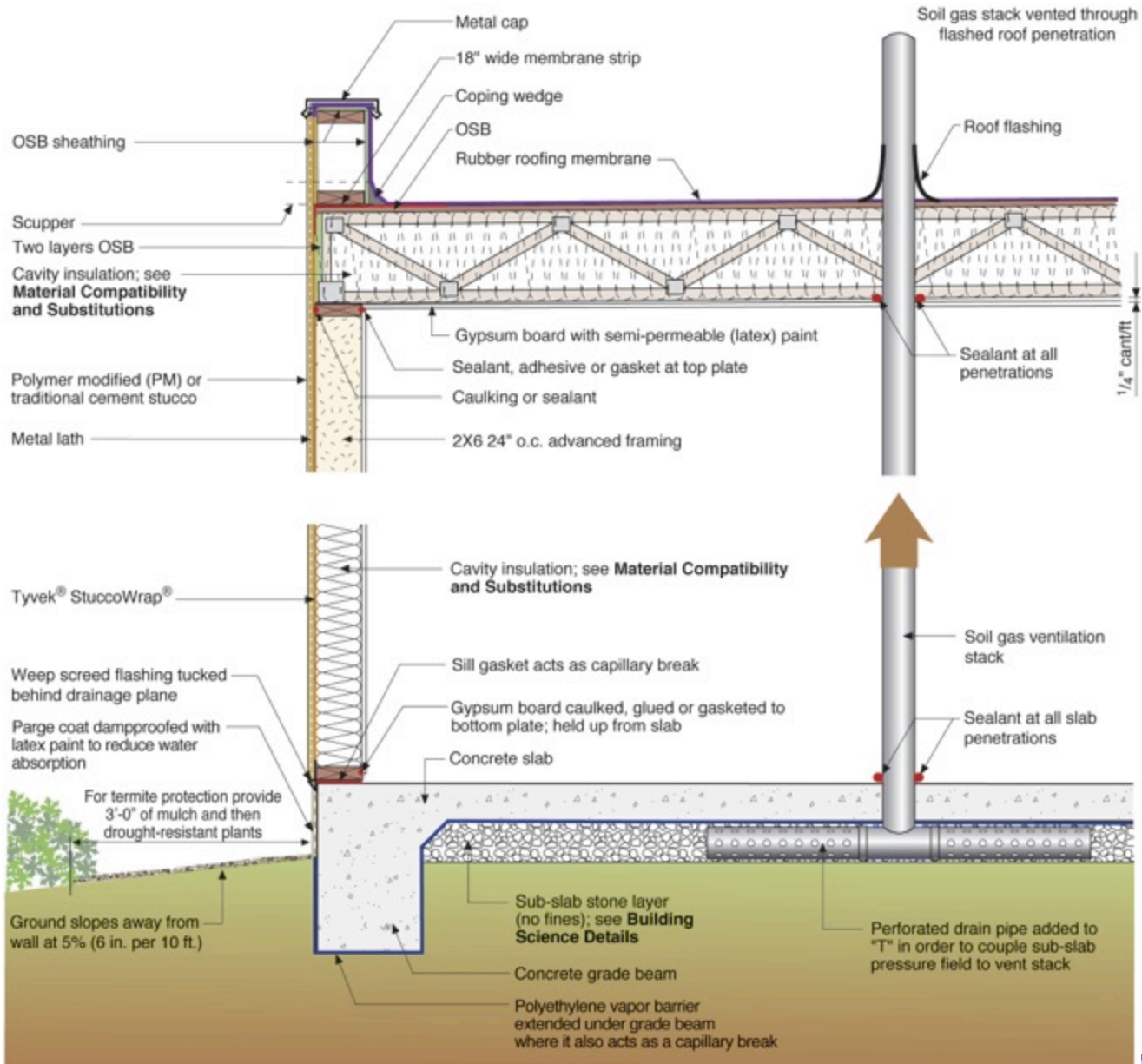

Truss Uplift







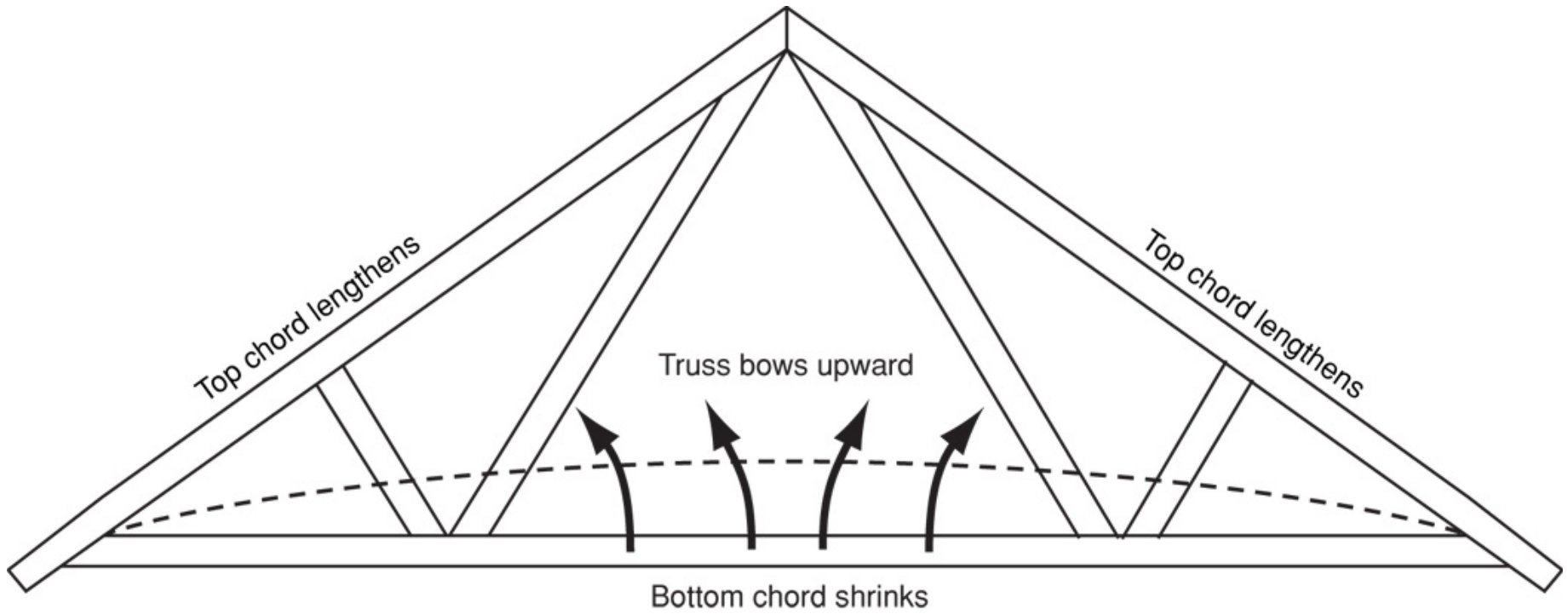

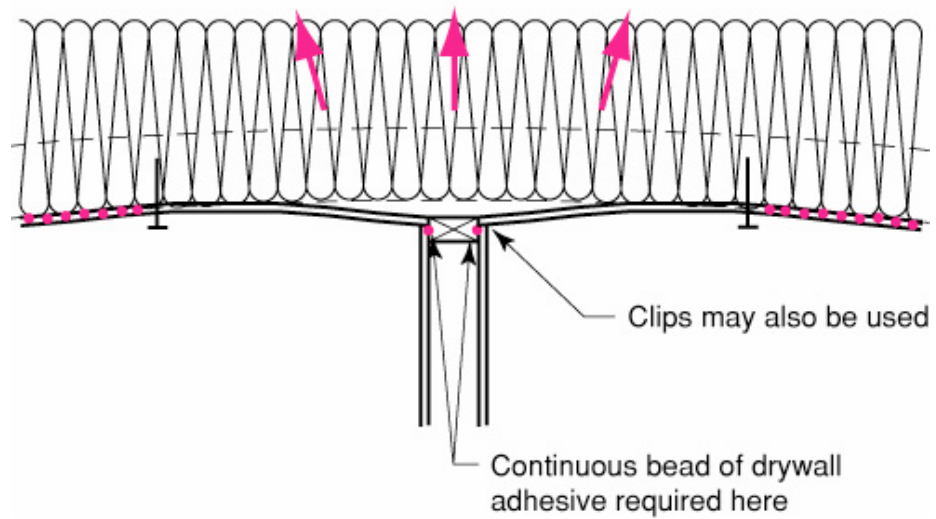
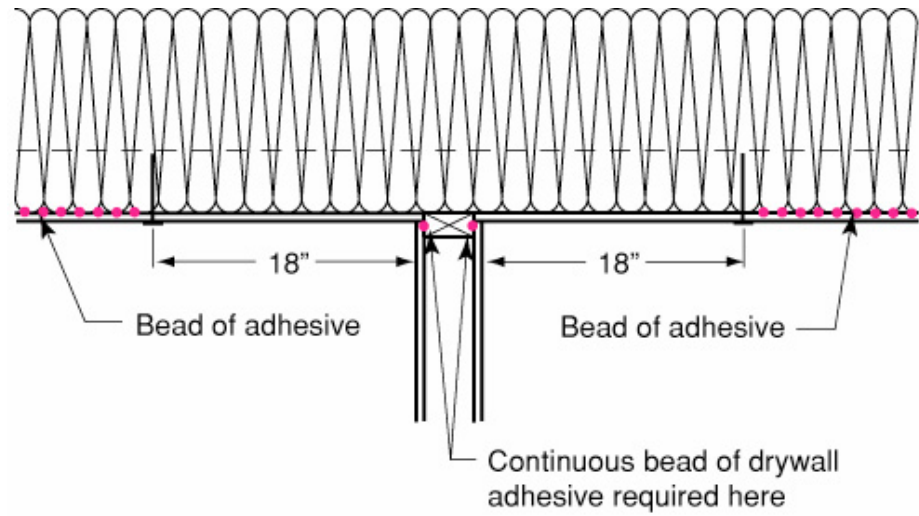

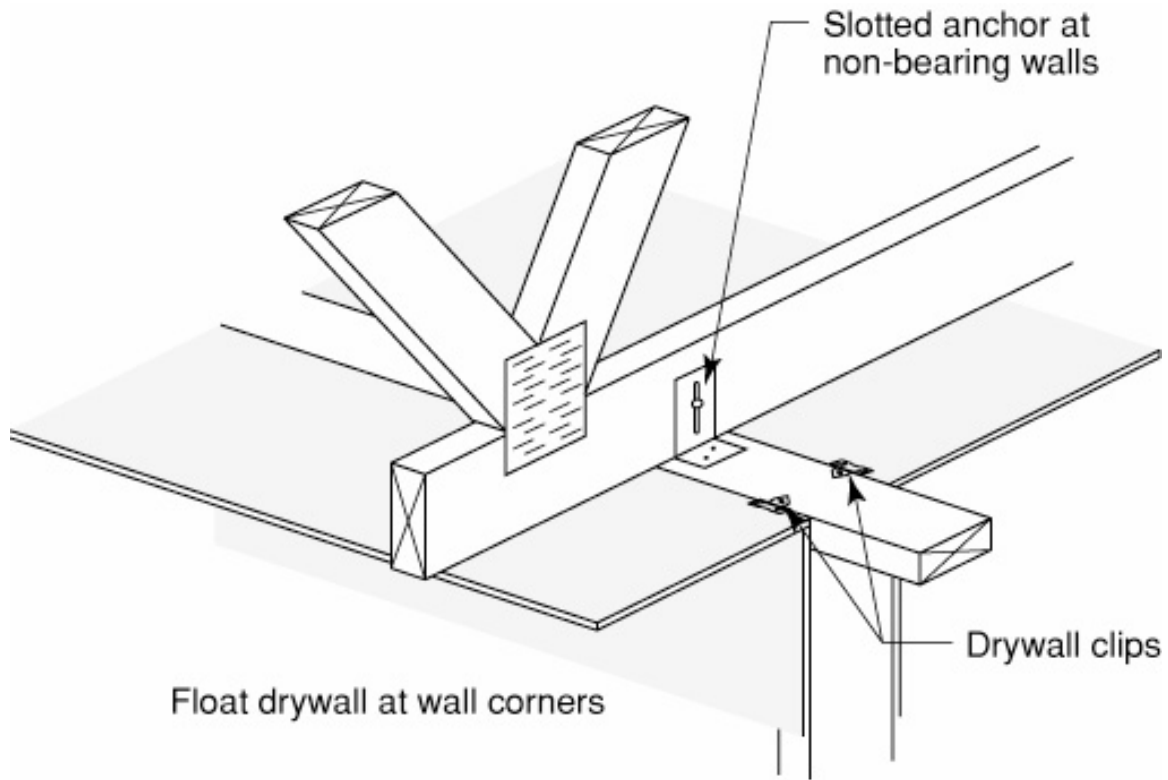





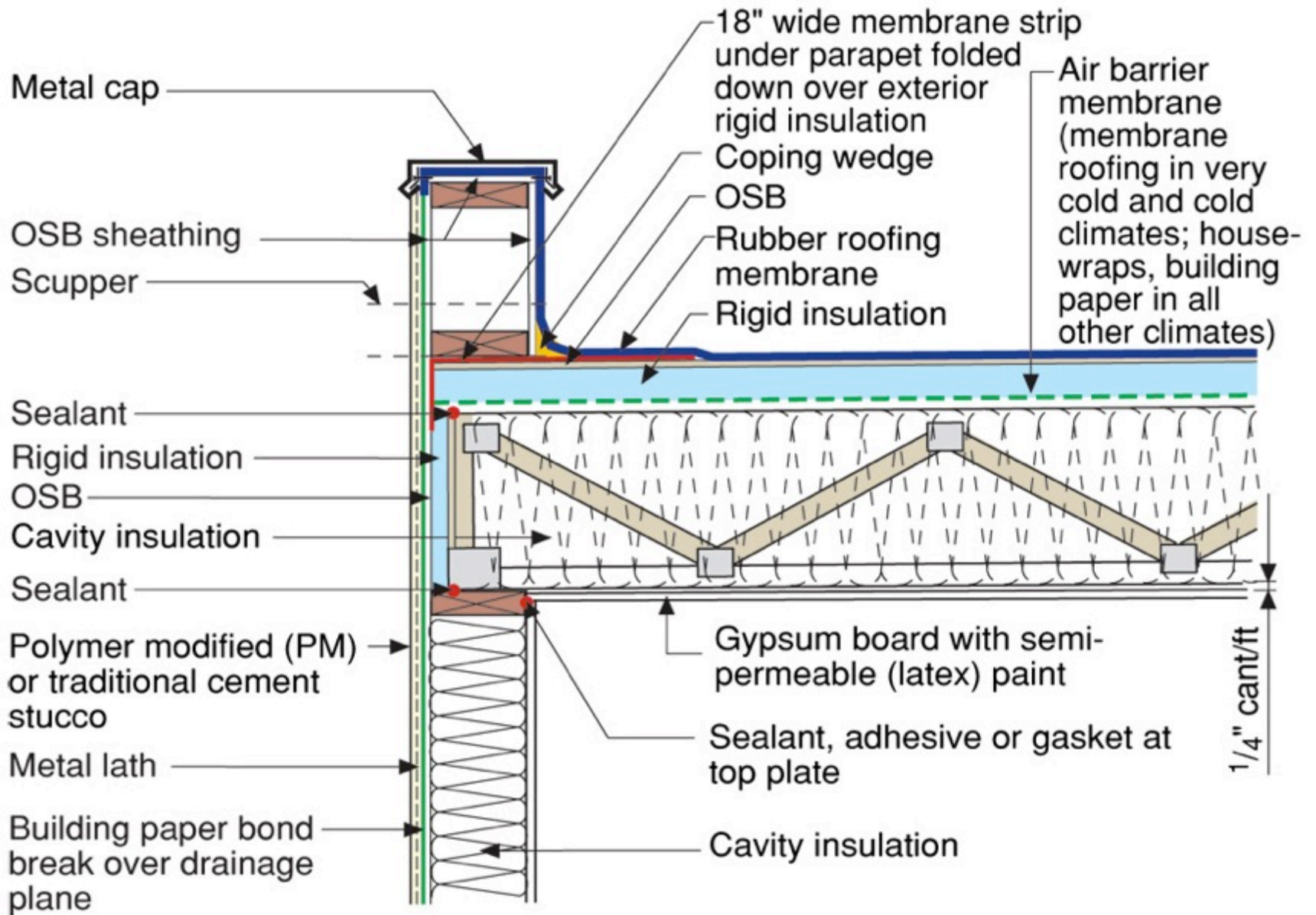

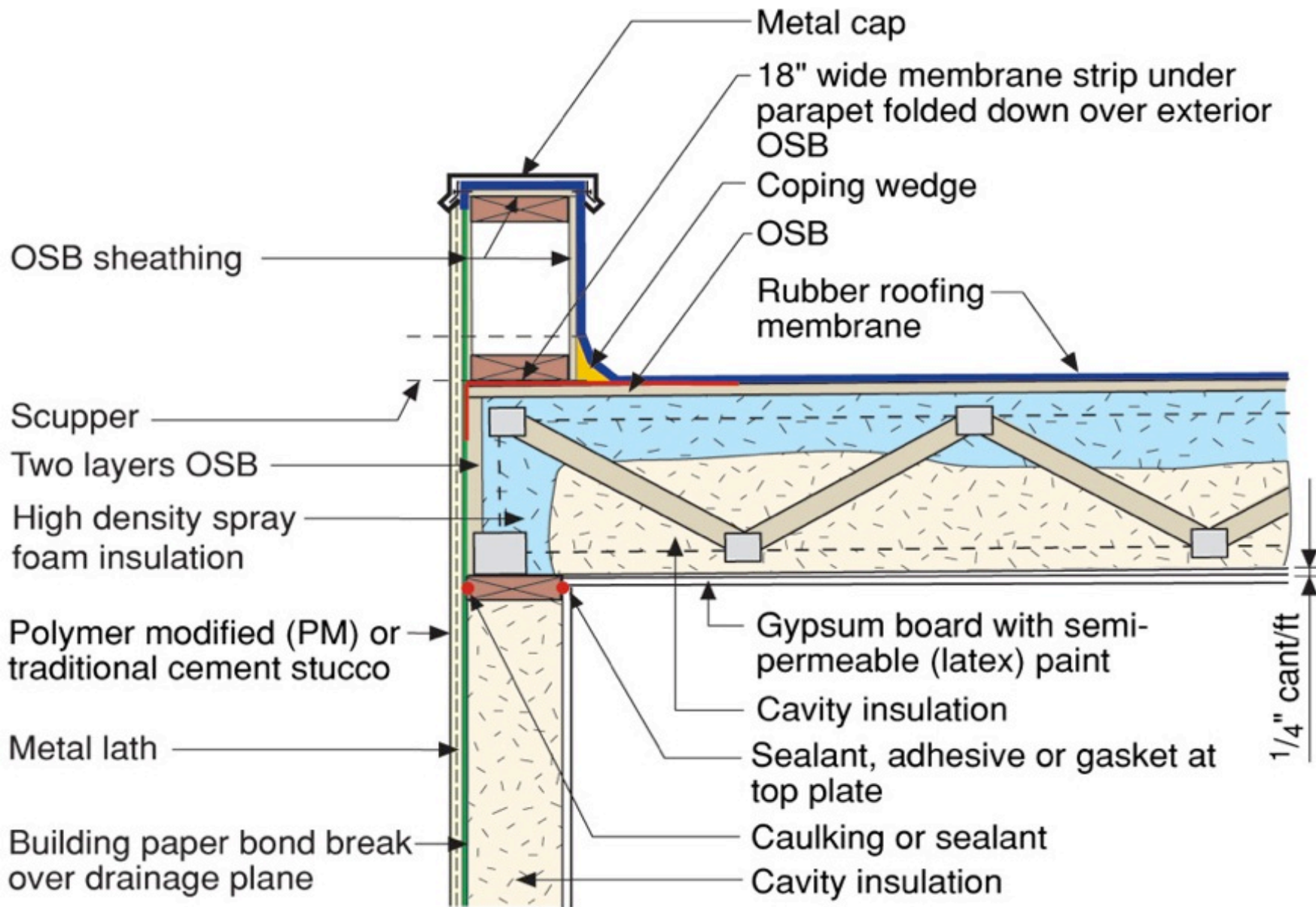

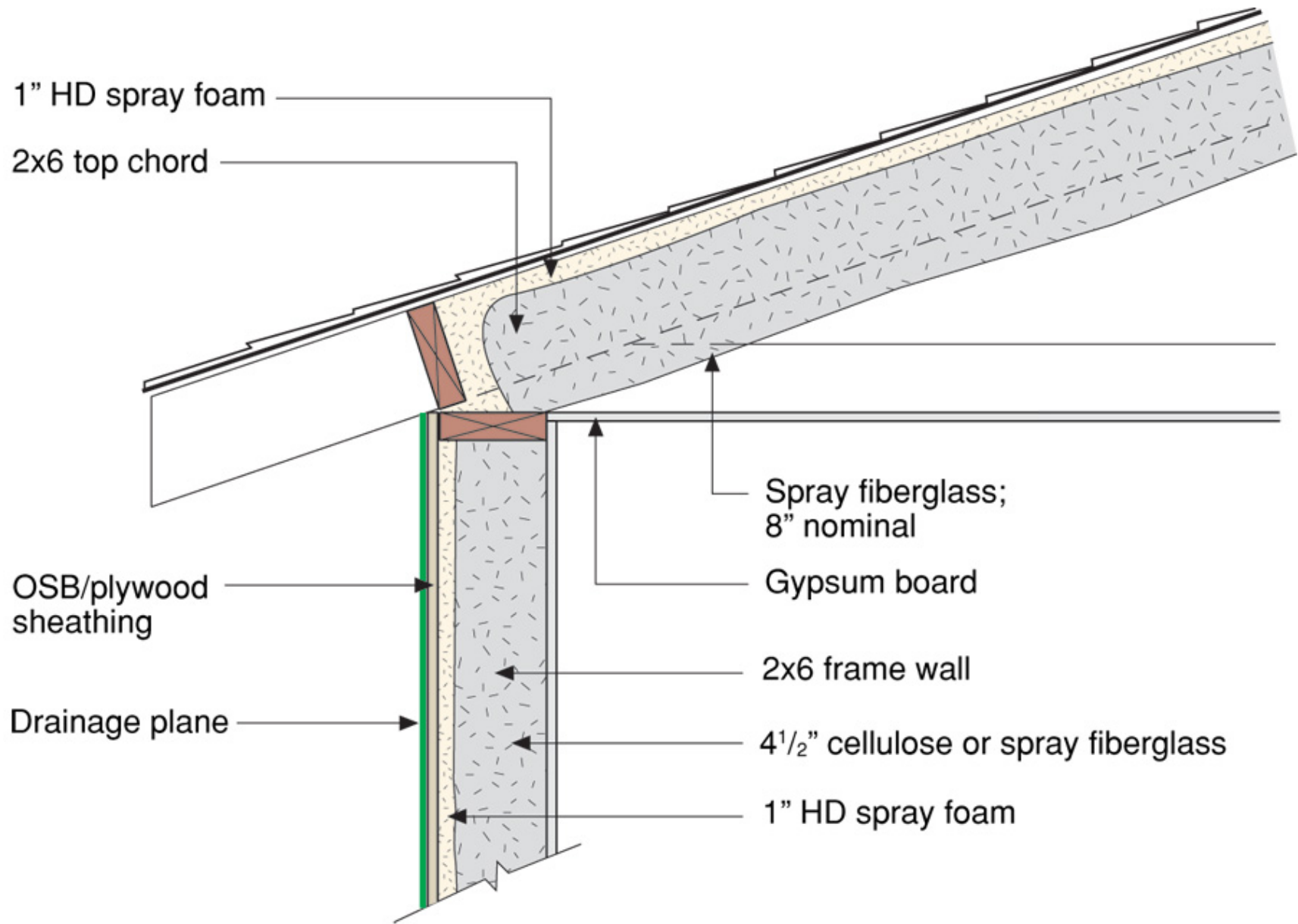

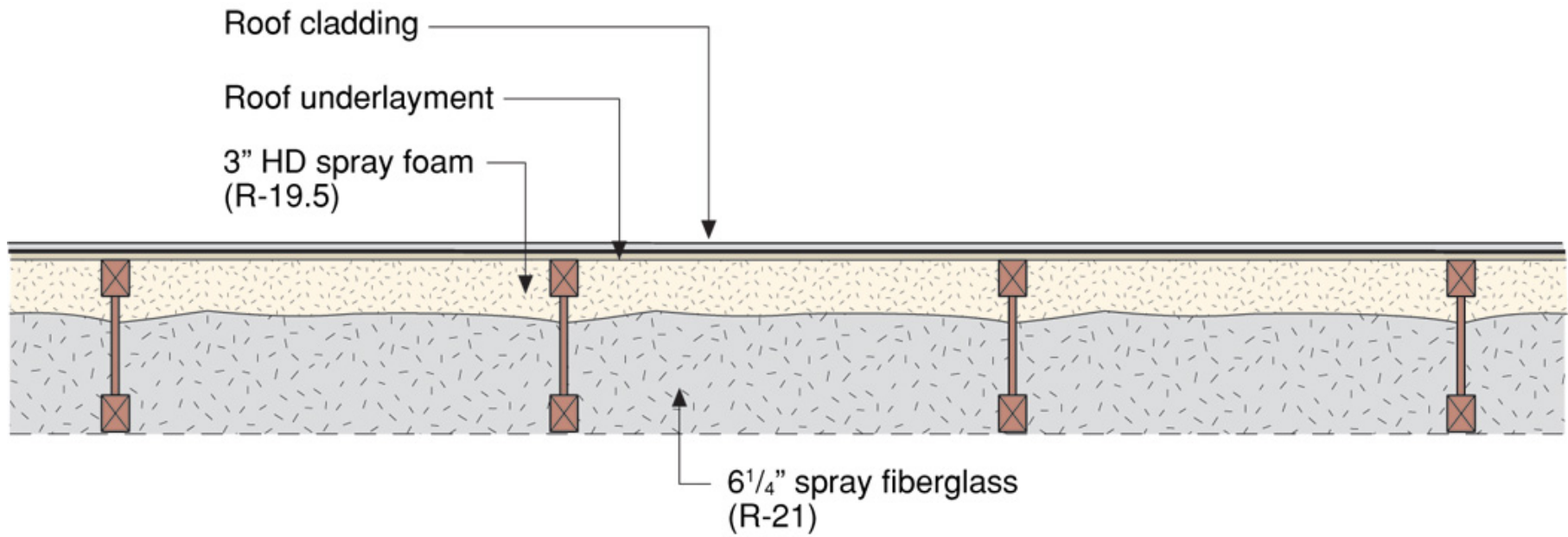

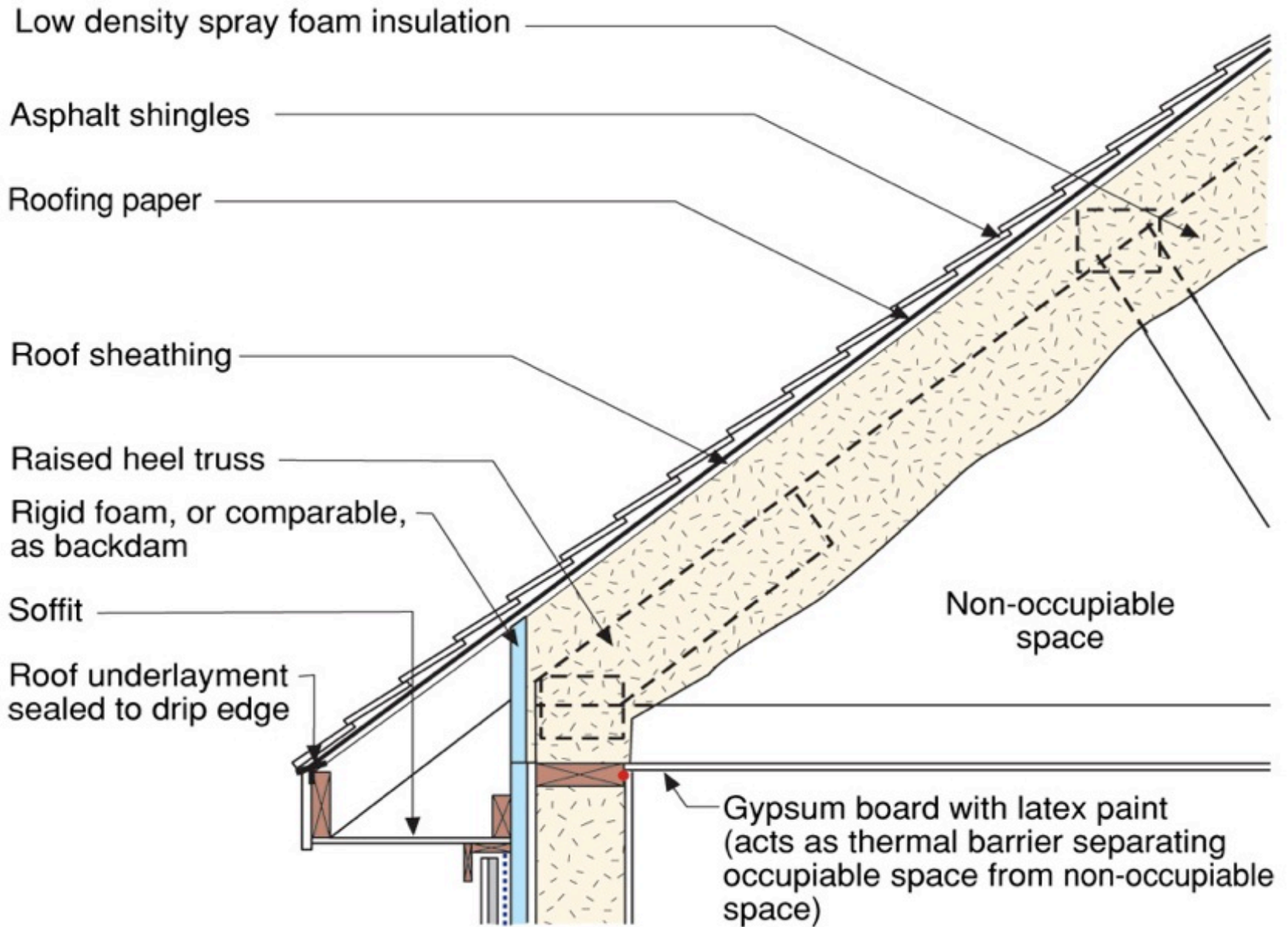

















Map of DOE's Proposed Climate Zones

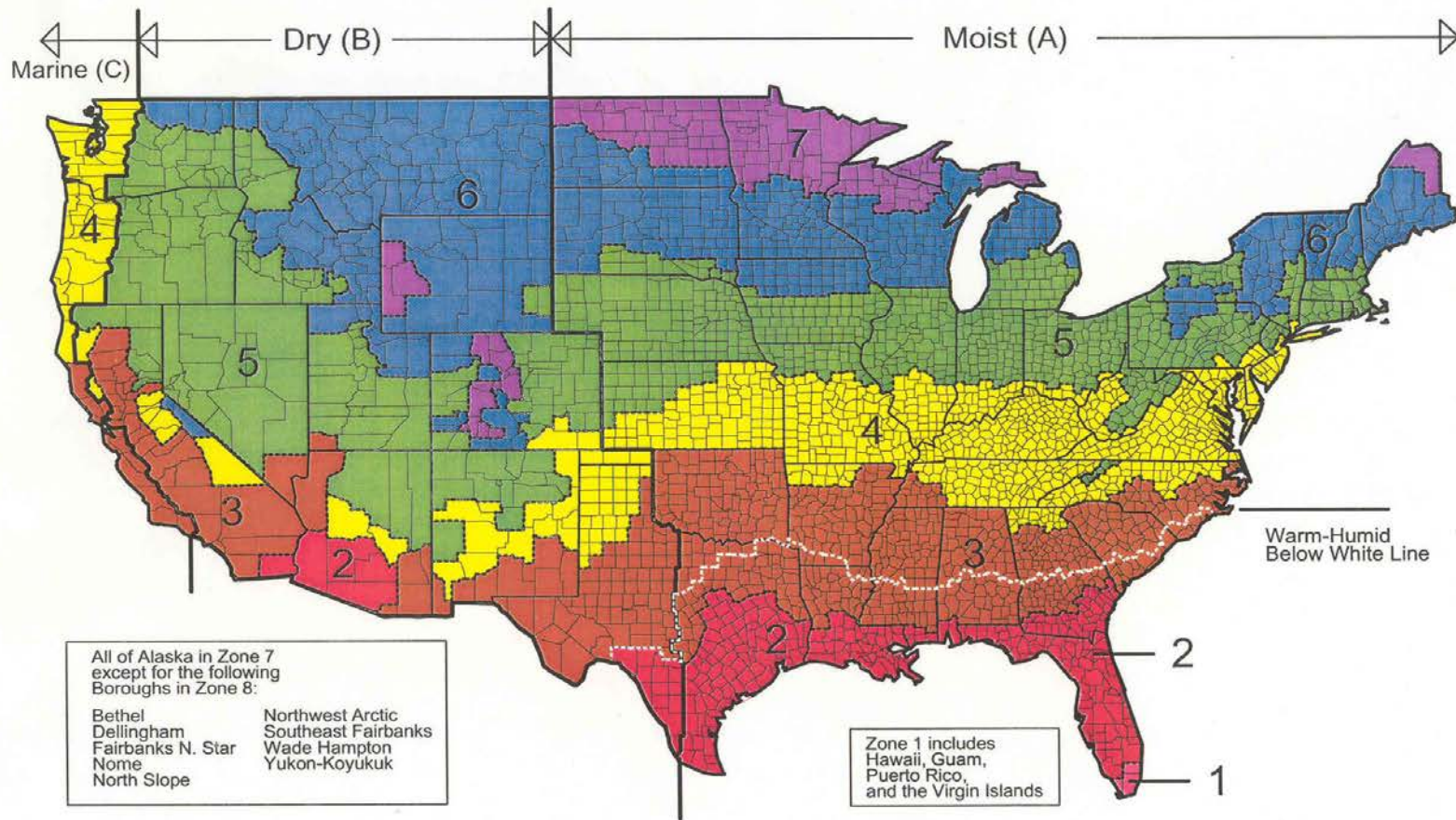

March 24, 2003

Conditioned Attics Not Unvented Attics

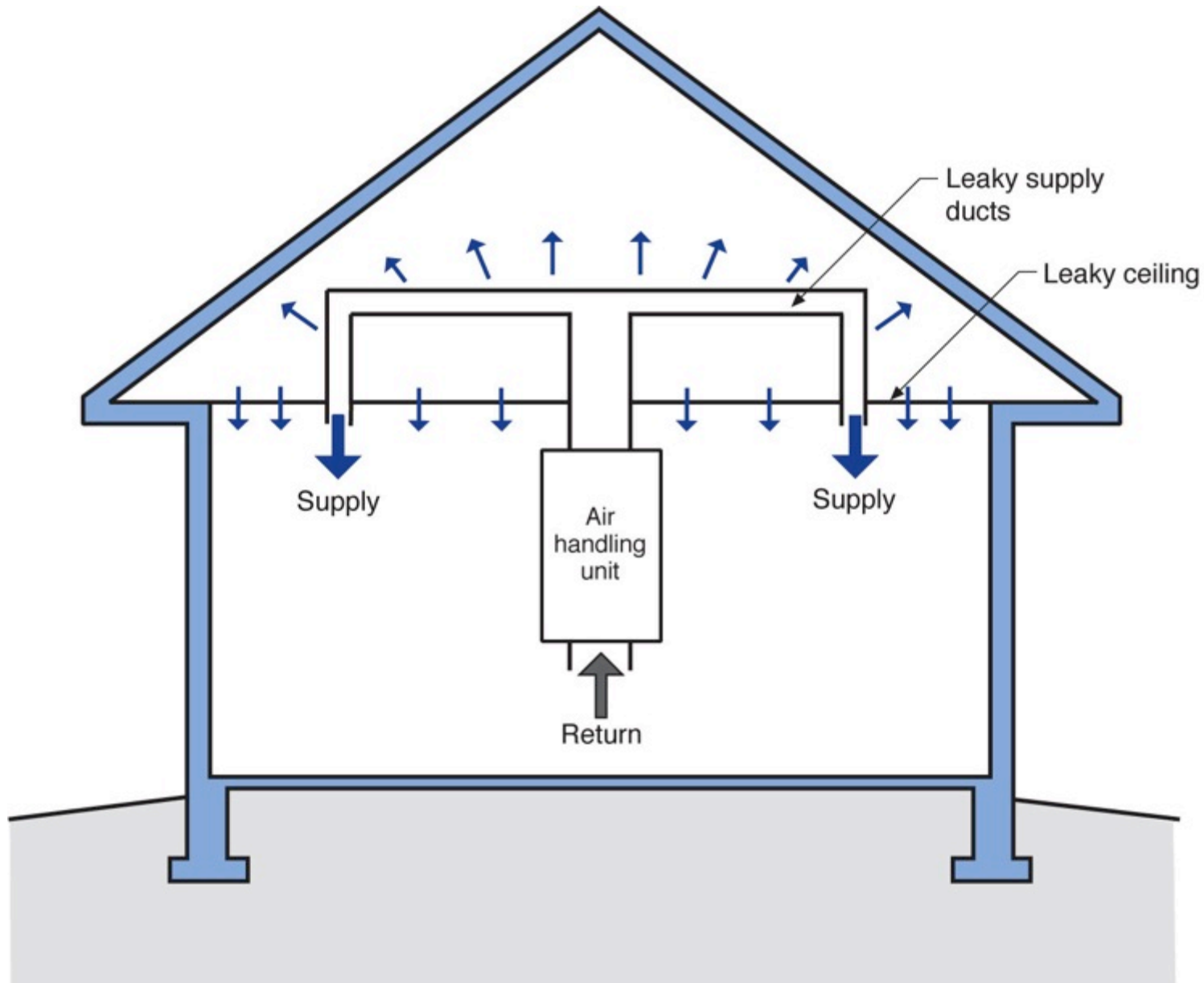



Conditioned Attics Not Unvented Attics Need Supply Air

Conditioned Attics Not Unvented Attics
Need Supply Air
50 cfm/1000 ft² of Attic

Hygric Buoyancy

Components in Dry Air	Volume Ratio compared to Dry Air	Molecular Mass - M (kg/kmol)	Molecular Mass in Air
Oxygen	0.2095	32.00	6.704
Nitrogen	0.7809	28.02	21.88
Carbon Dioxide	0.0003	44.01	0.013
Hydrogen	0.0000005	2.02	0
Argon	0.00933	39.94	0.373
Neon	0.000018	20.18	0
Helium	0.000005	4.00	0
Krypton	0.000001	83.8	0
Xenon	$0.09 \cdot 10^{-6}$	131.29	0
Total Molecular Mass of Air			28.97

Components in Dry Air	Volume Ratio compared to Dry Air	Molecular Mass - M (kg/kmol)	Molecular Mass in Air
Oxygen	0.2095	32.00	6.704
Nitrogen	0.7809	28.02	21.88
Carbon Dioxide	0.0003	44.01	0.013
Hydrogen	0.0000005	2.02	0
Argon	0.00933	39.94	0.373
Neon	0.000018	20.18	0
Helium	0.000005	4.00	0
Krypton	0.000001	83.8	0
Xenon	$0.09 \cdot 10^{-6}$	131.29	0
Total Molecular Mass of Air			28.97

Note Water Vapor (H₂O) is 18

Dry Air is 29

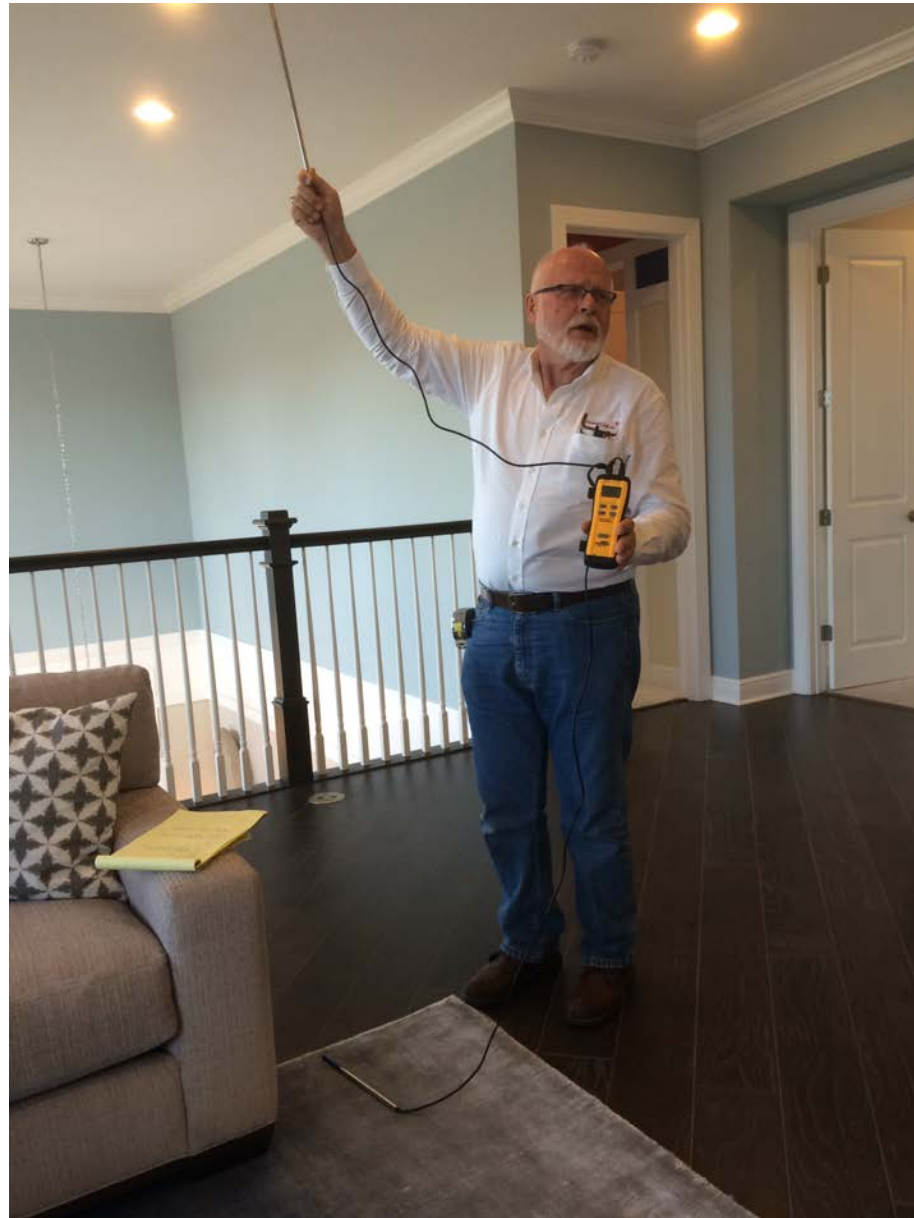



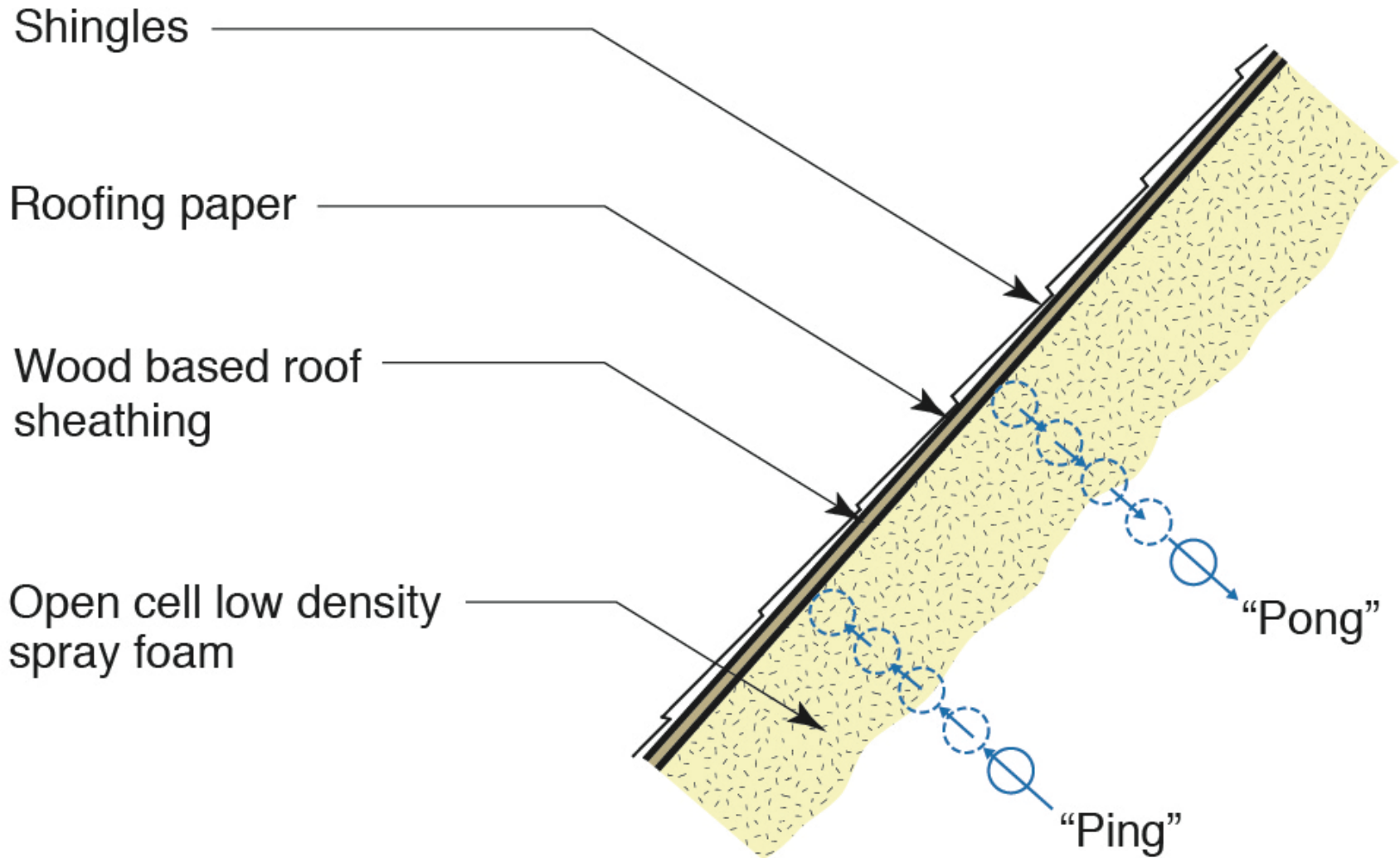

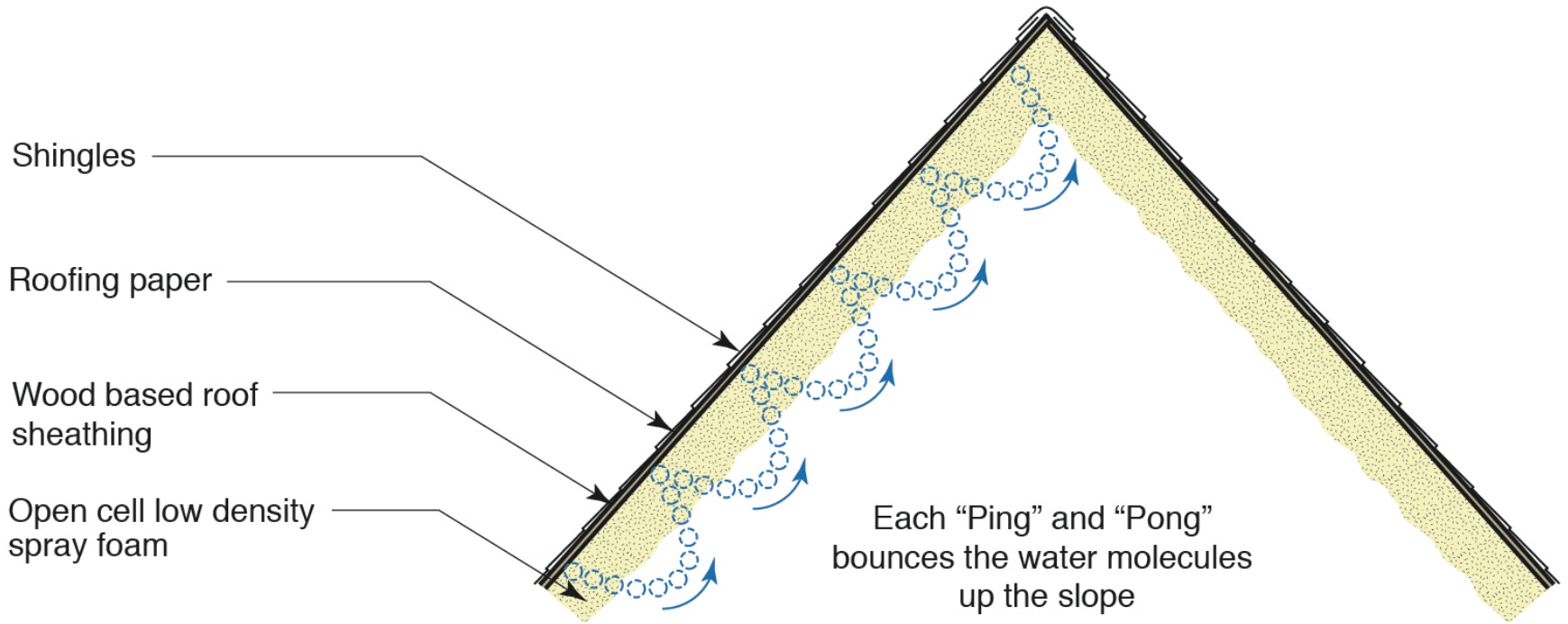

FRF Data: June 1 - September 30, 1989

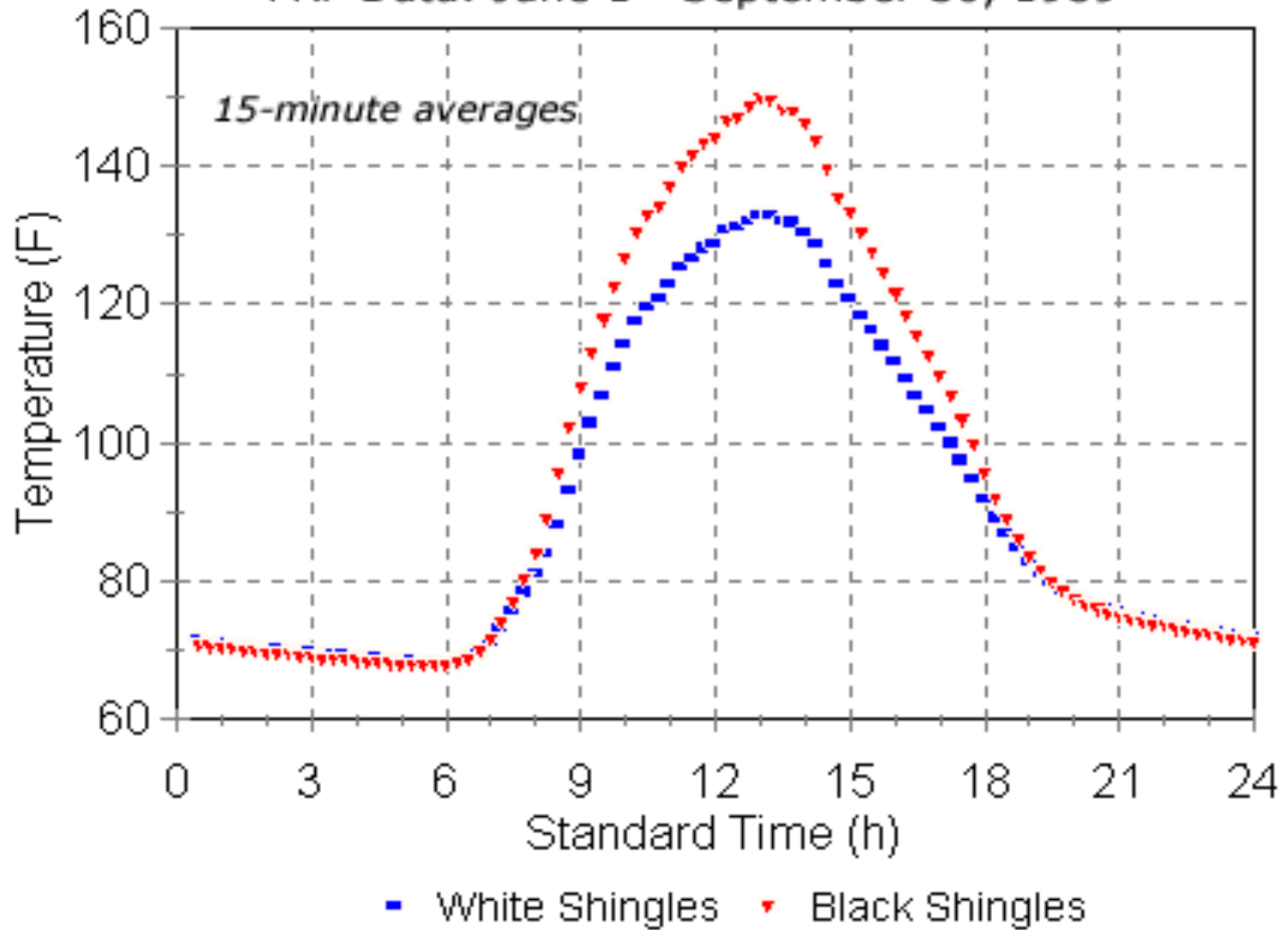

Vented vs. unvented shingle temperatures

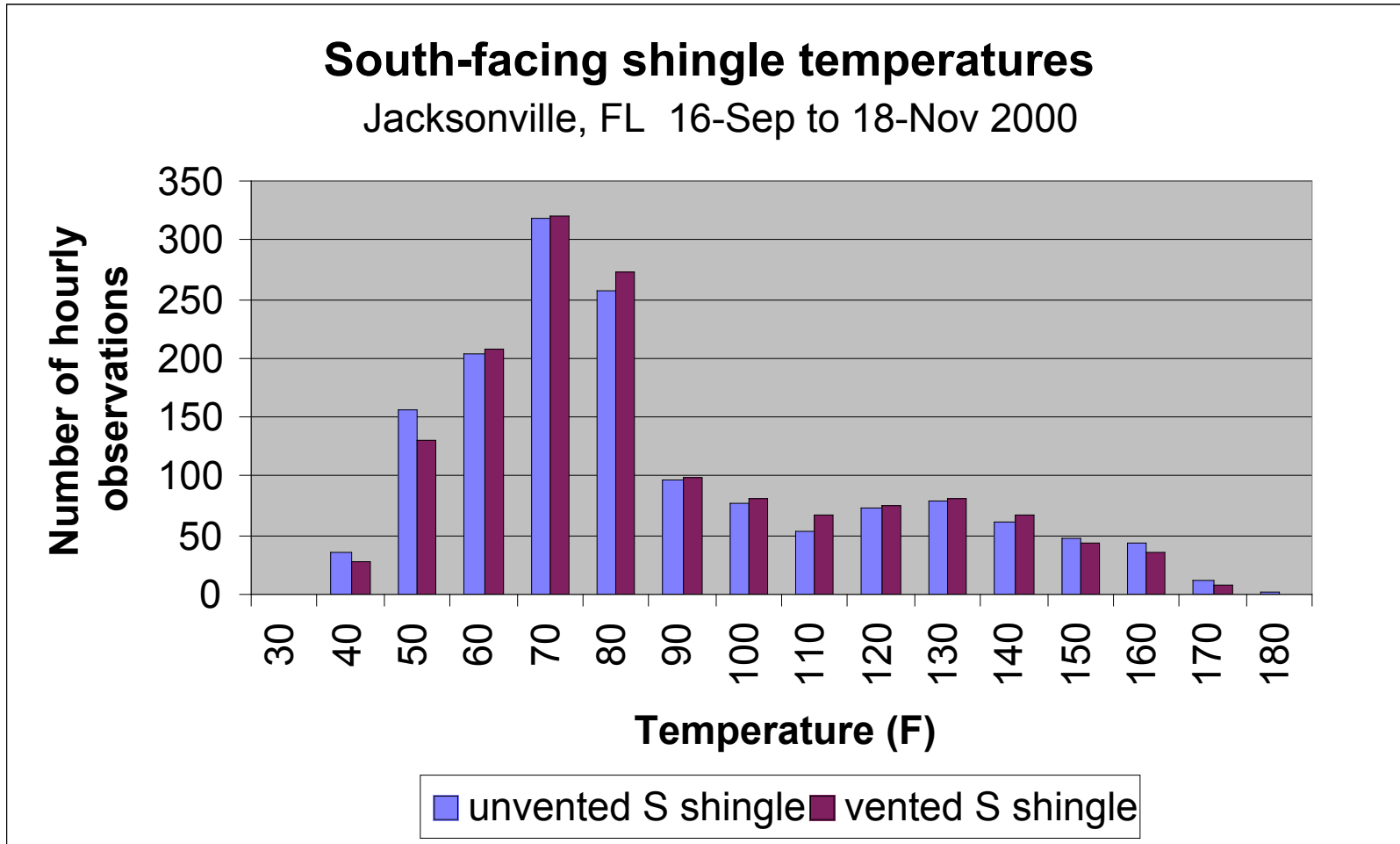

Average Temperatures Vented and Unvented Attics, Aug-97

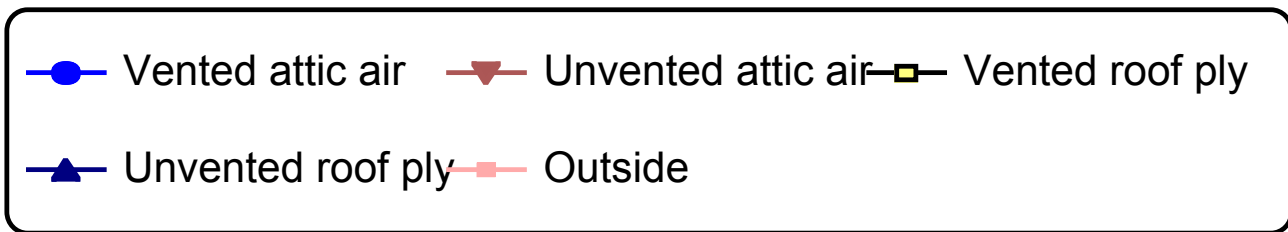
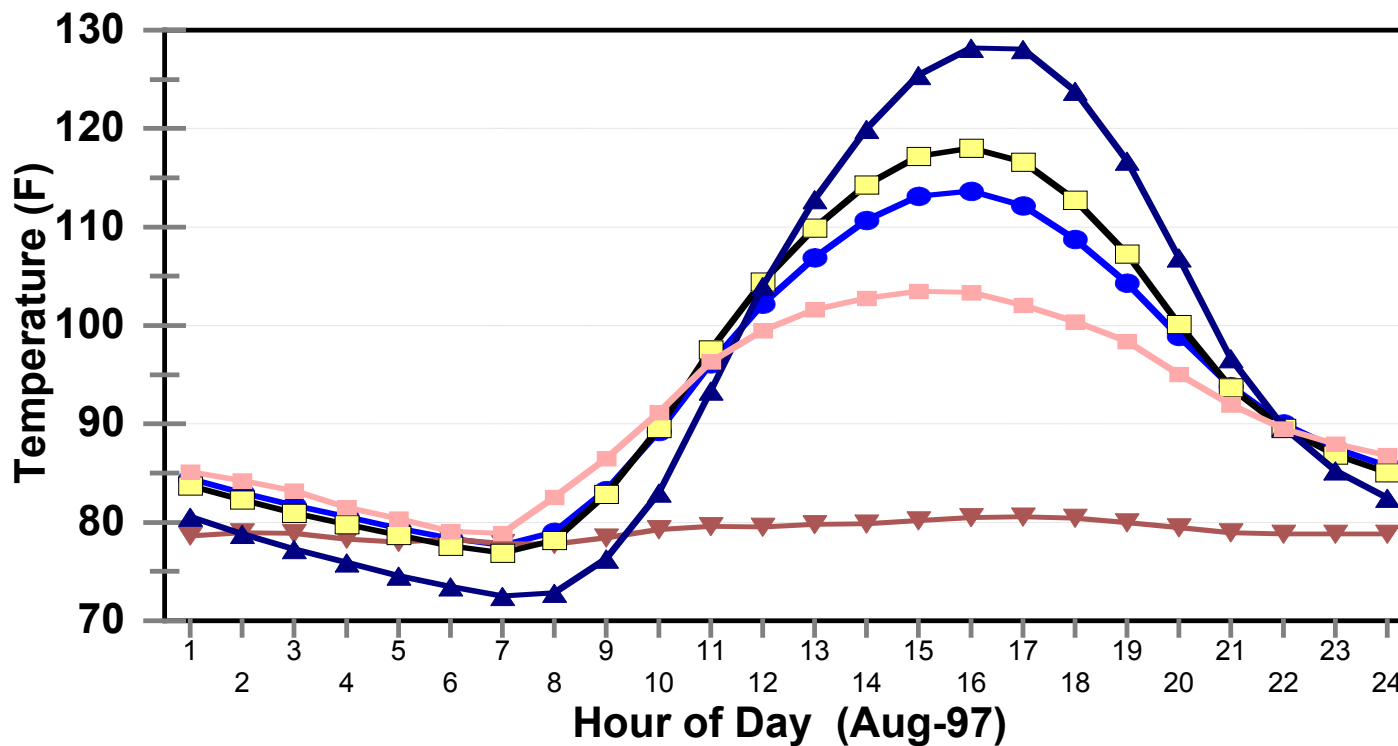

Hourly Maximim Roof Deck Temperature

LV24 and LV22

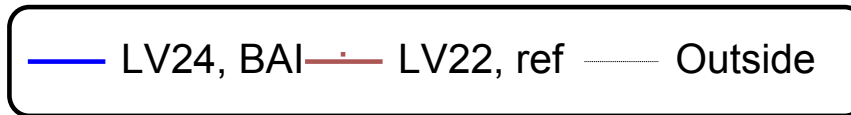
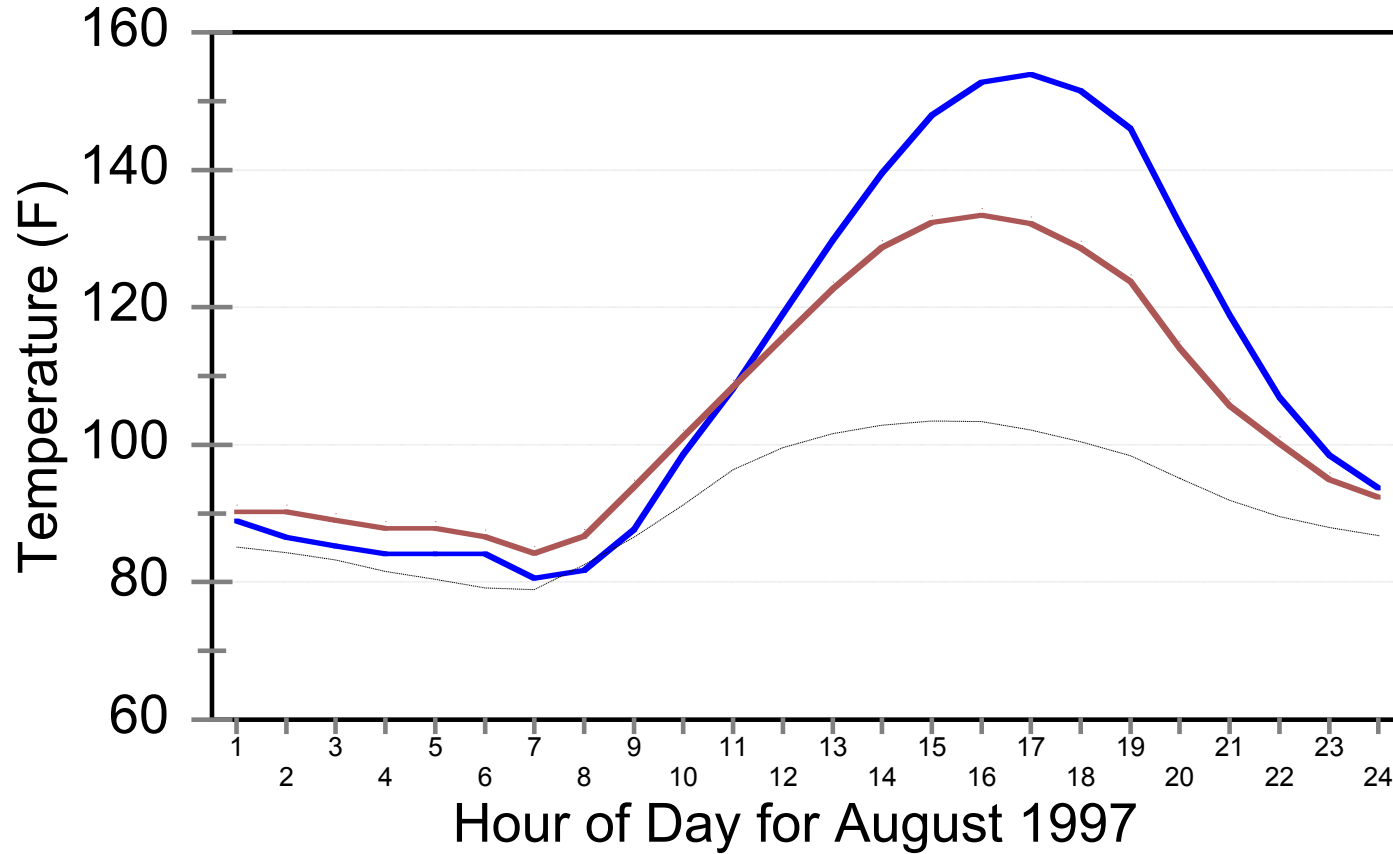

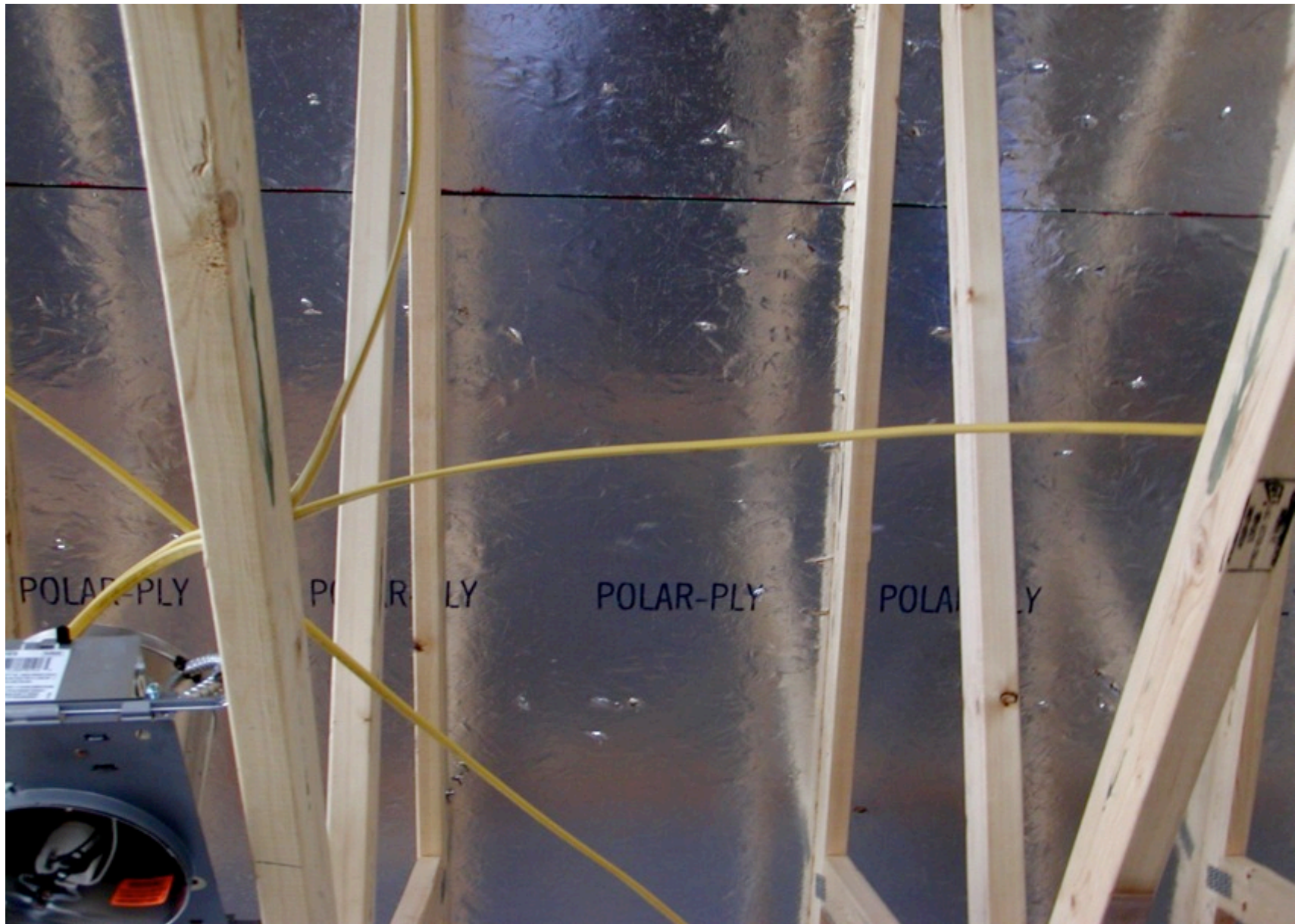

Roof Shingle Temperature

FSEC 3.0: Orlando, 1-Aug

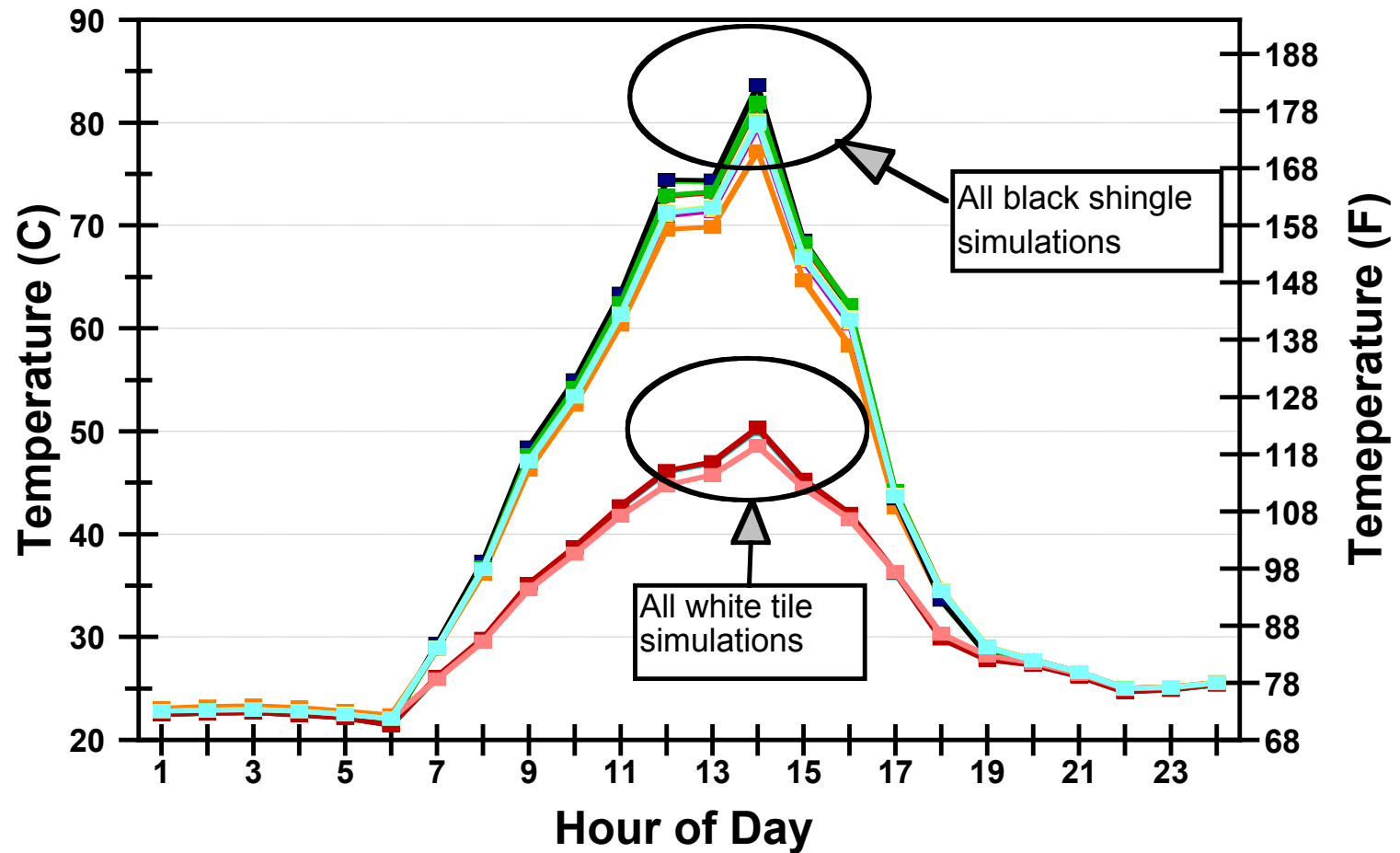

Bottom of Roof Plywood Temperature

FSEC 3.0: Orlando, 1-Aug

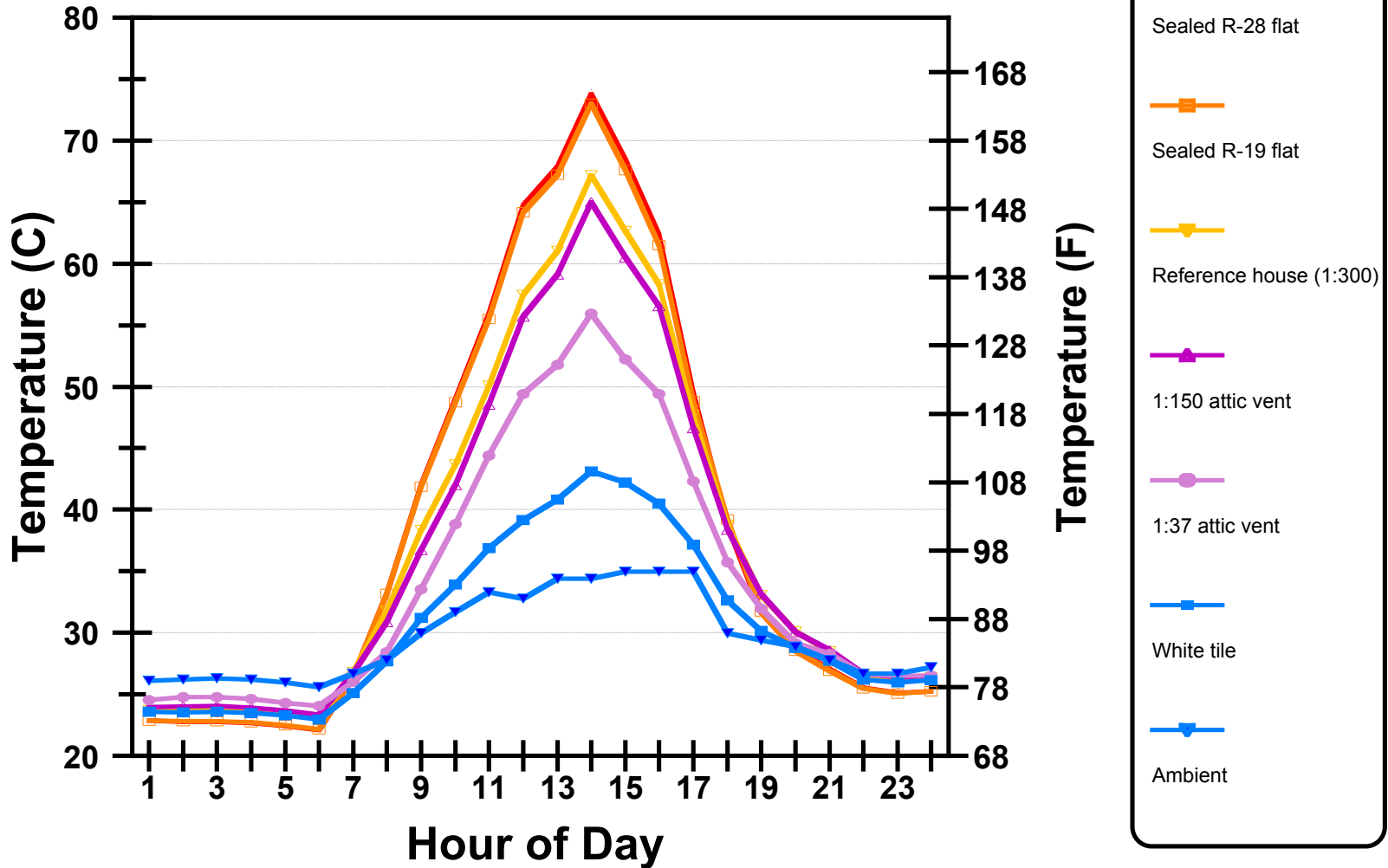

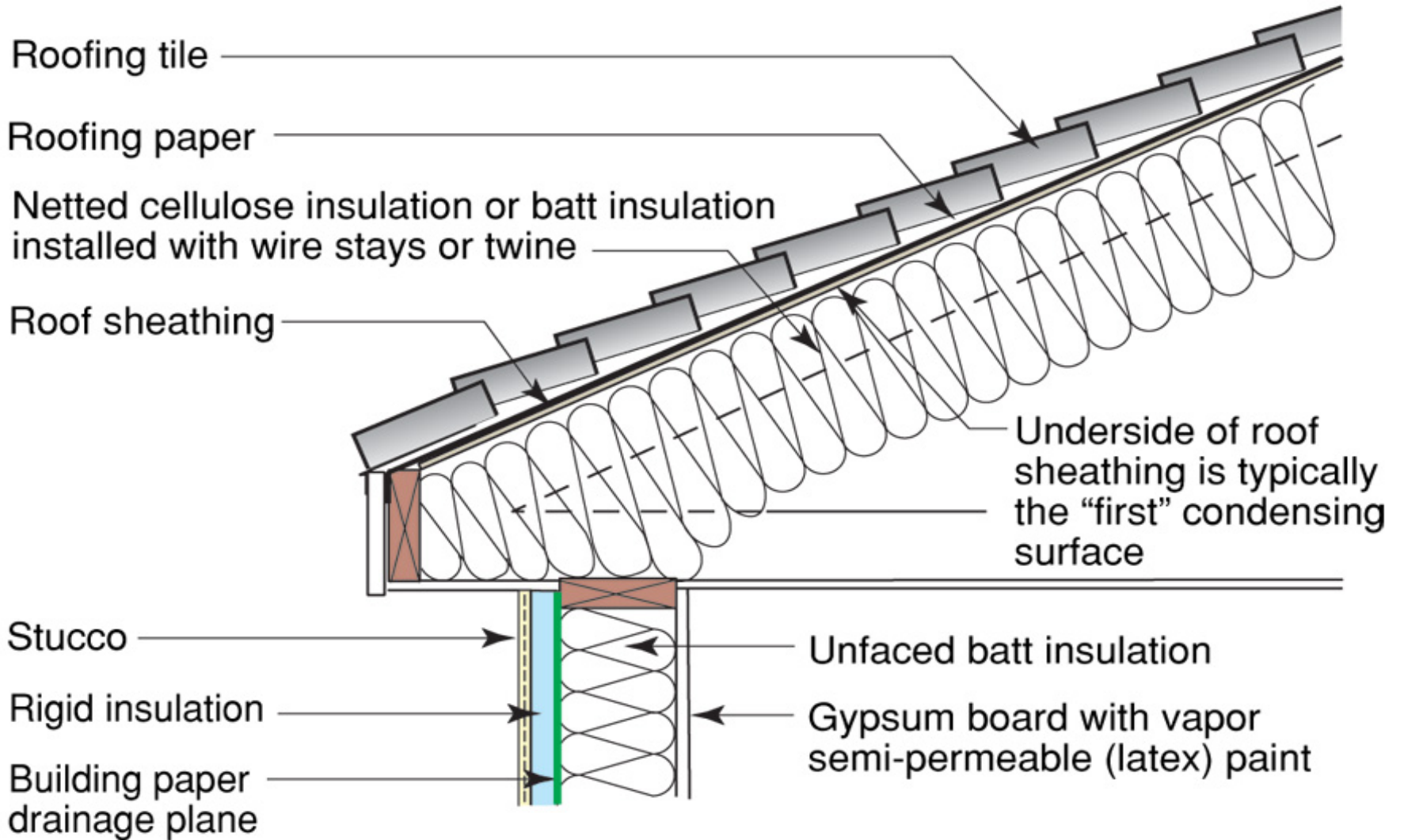

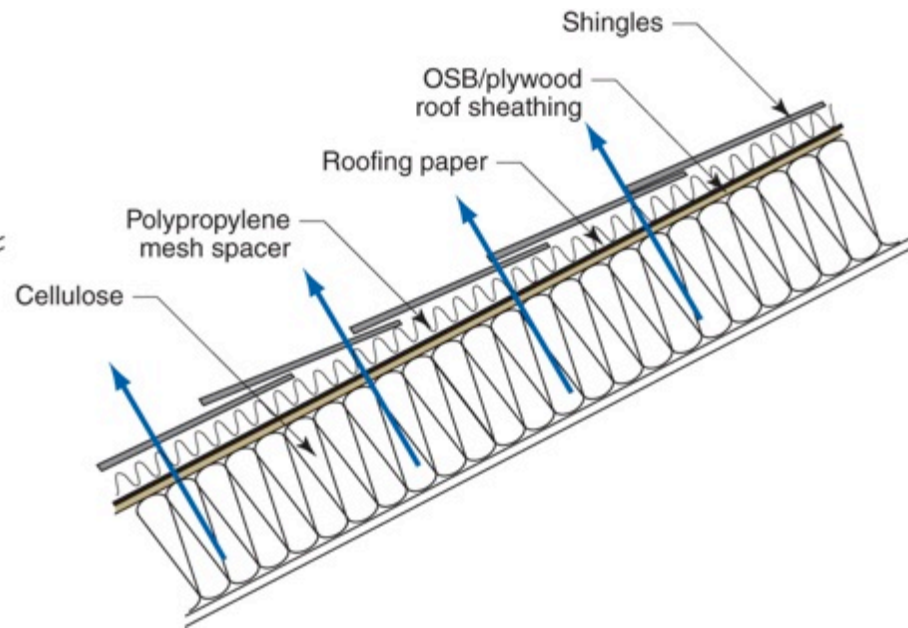
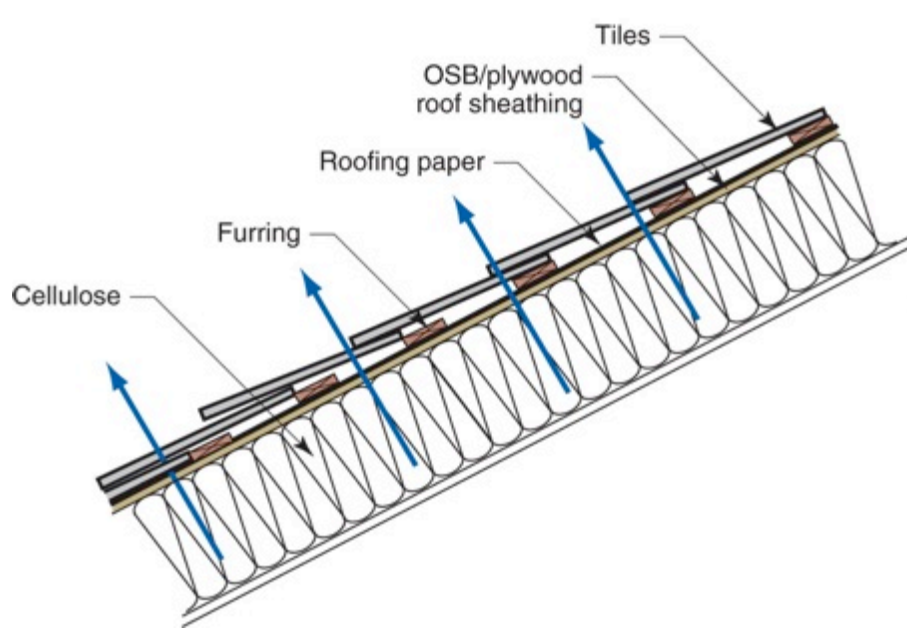











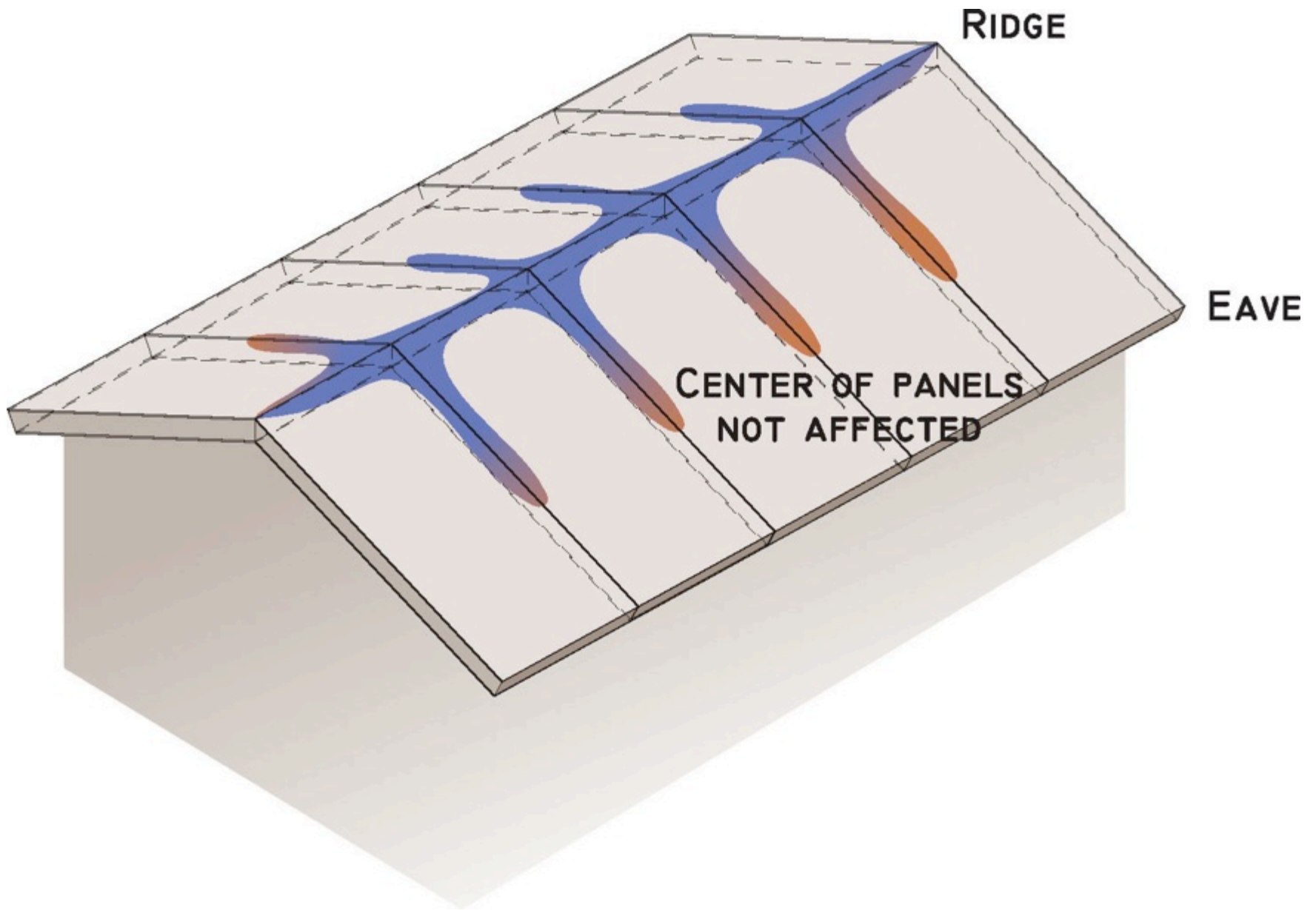









Step 1

- Remove strip of OSB from each side of ridge

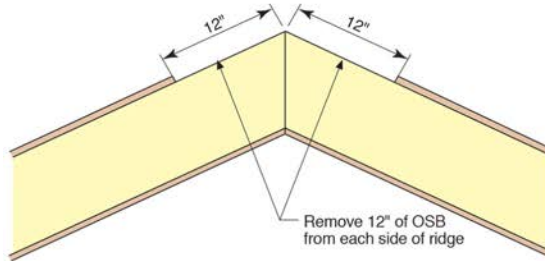

Step 2

- Create air seal with strip of vapor open membrane (tape seams)
- Vapor open membrane sheet sealed to OSB with acrylic caulk sealant
- Hold vapor open membrane sheet in place with metal strapping

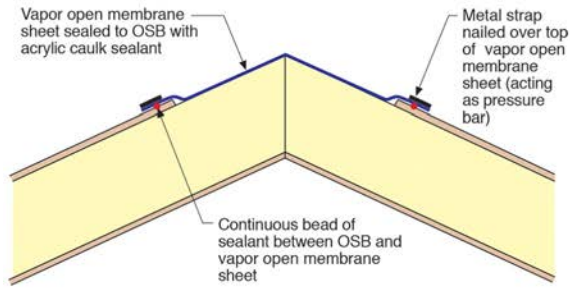

Step 3

- Construct wood ridge vent with 2x2 furring

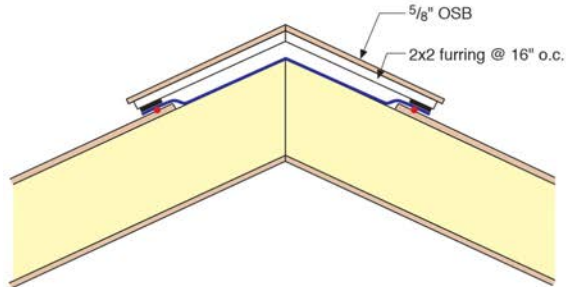

















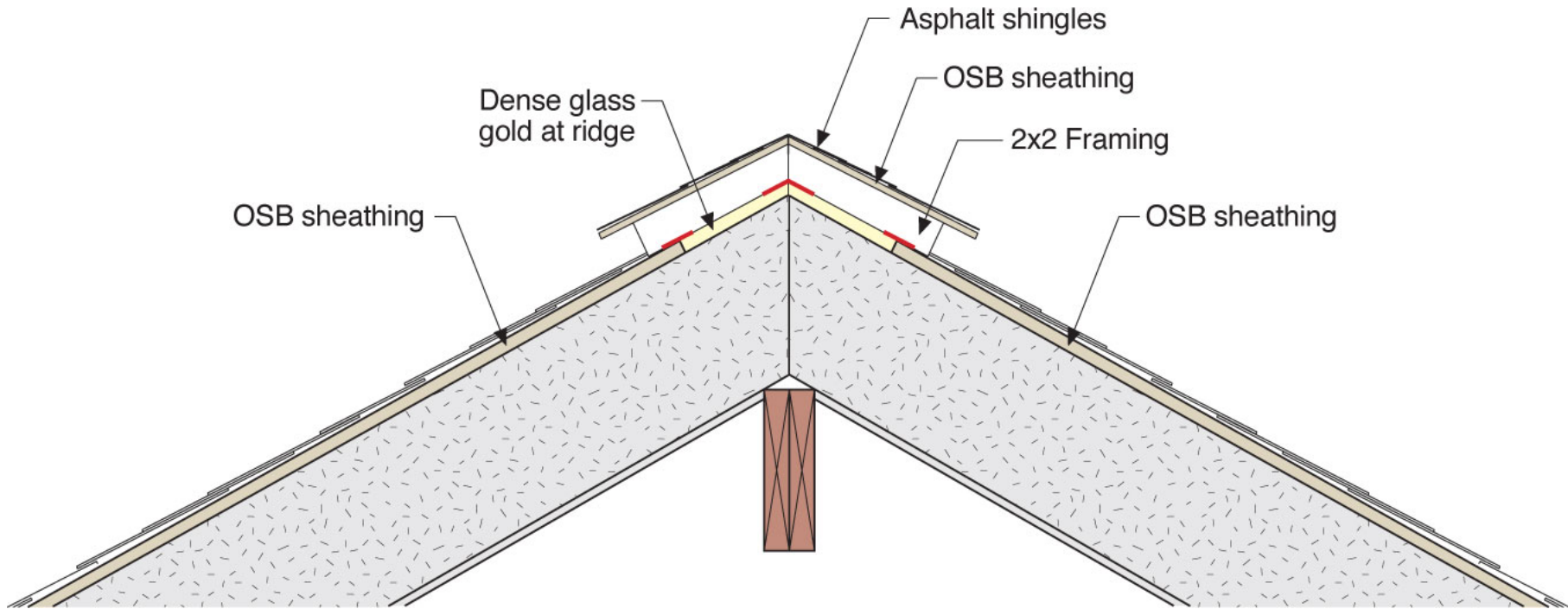

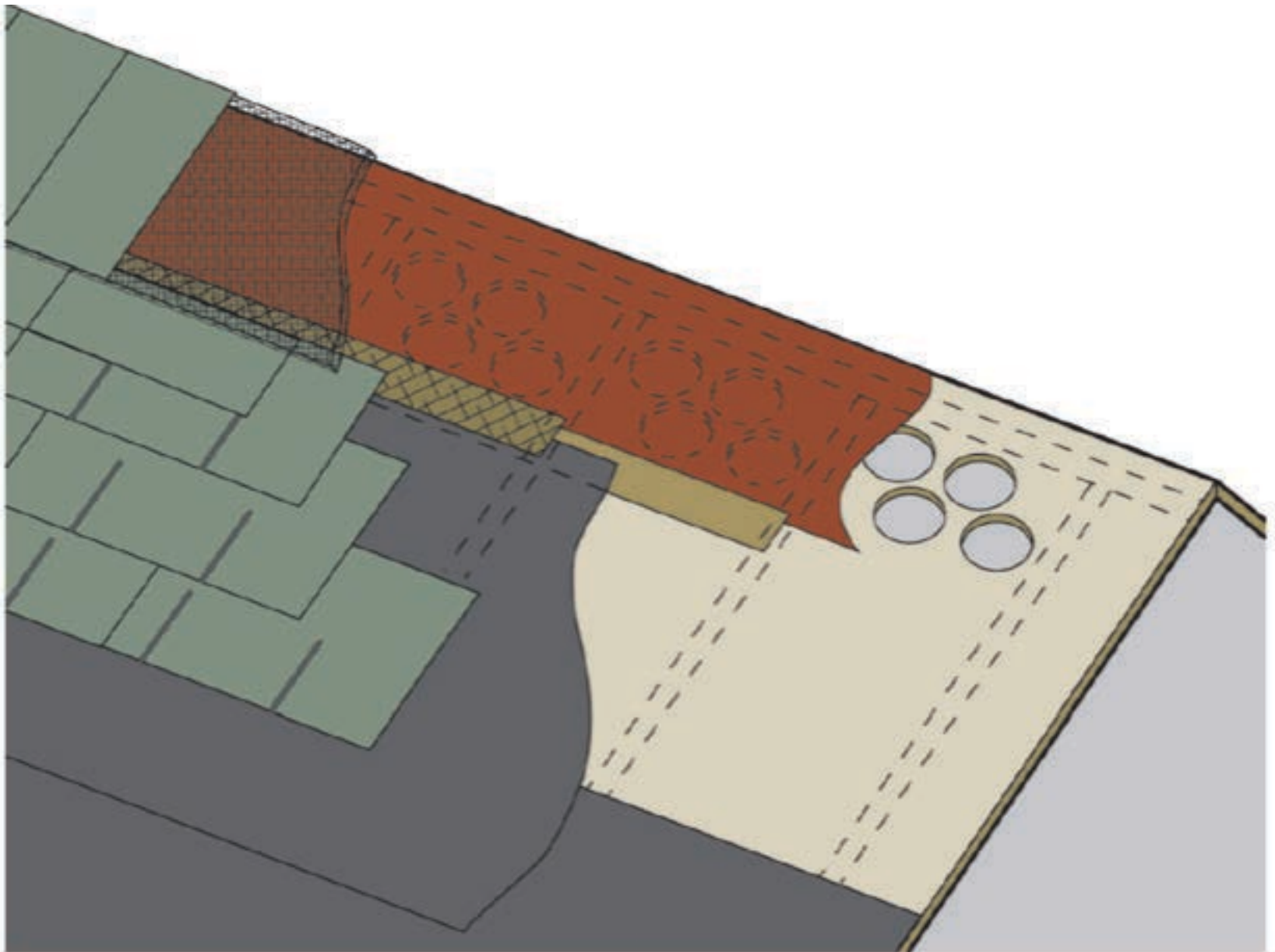

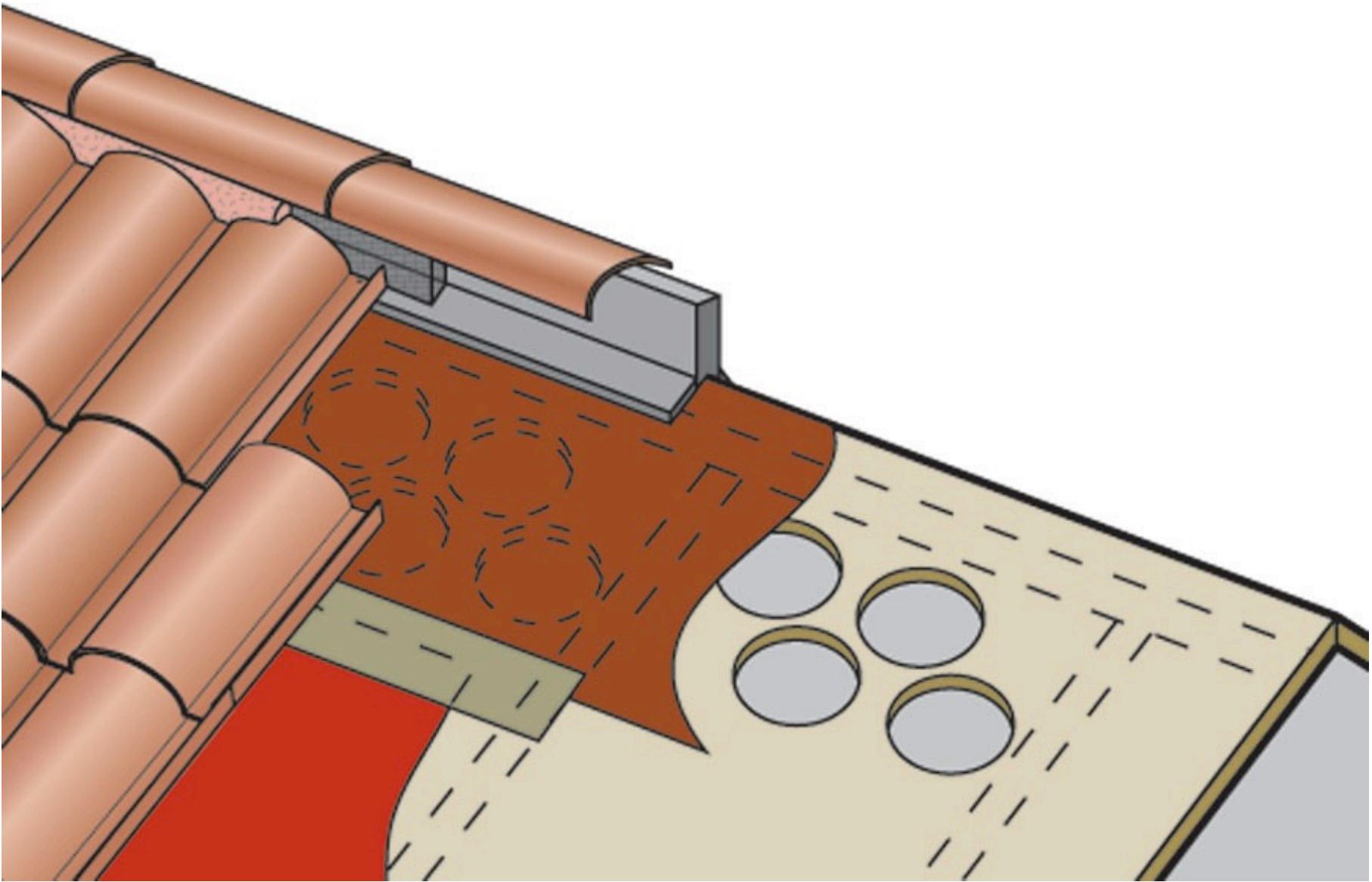

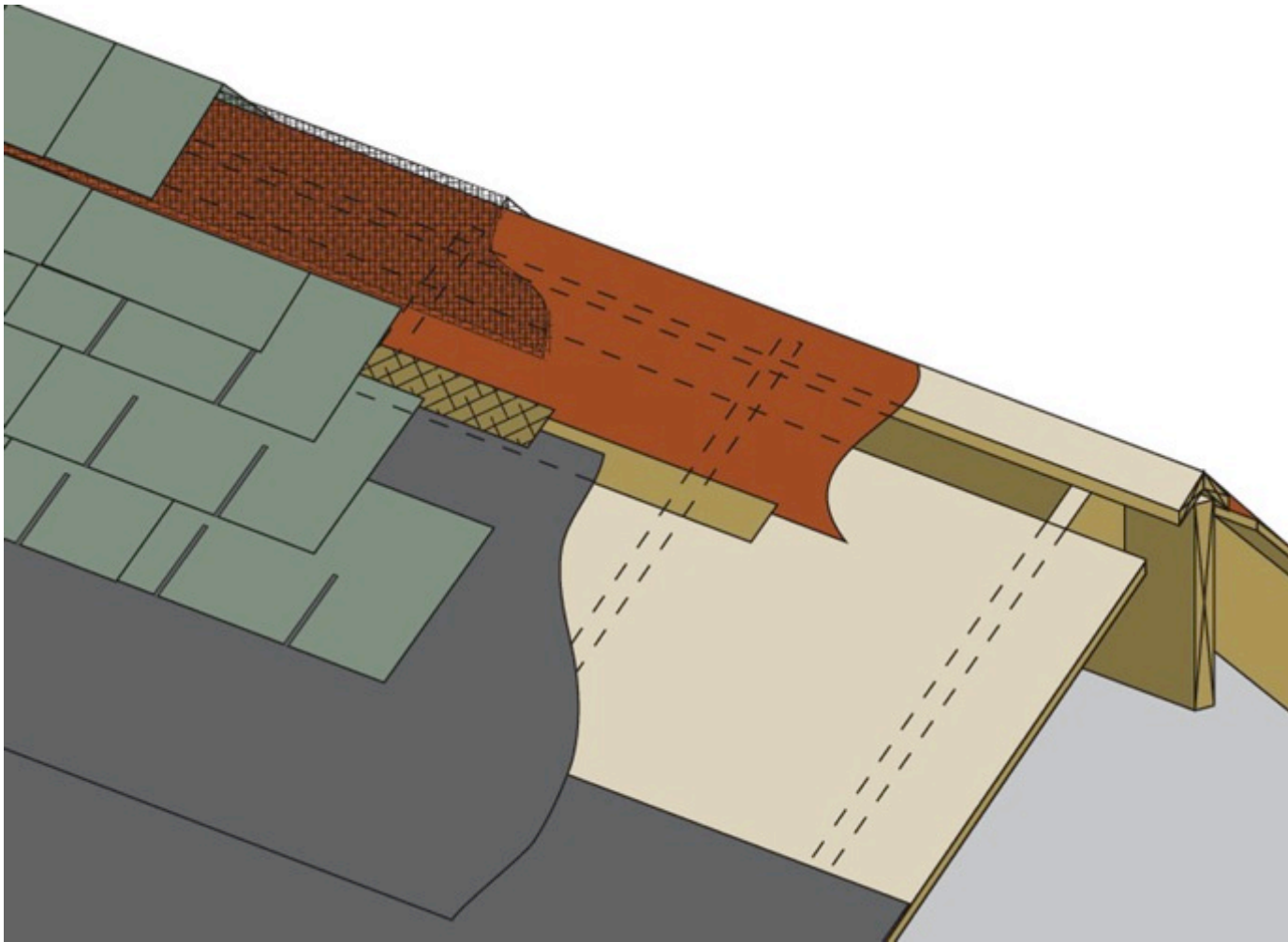

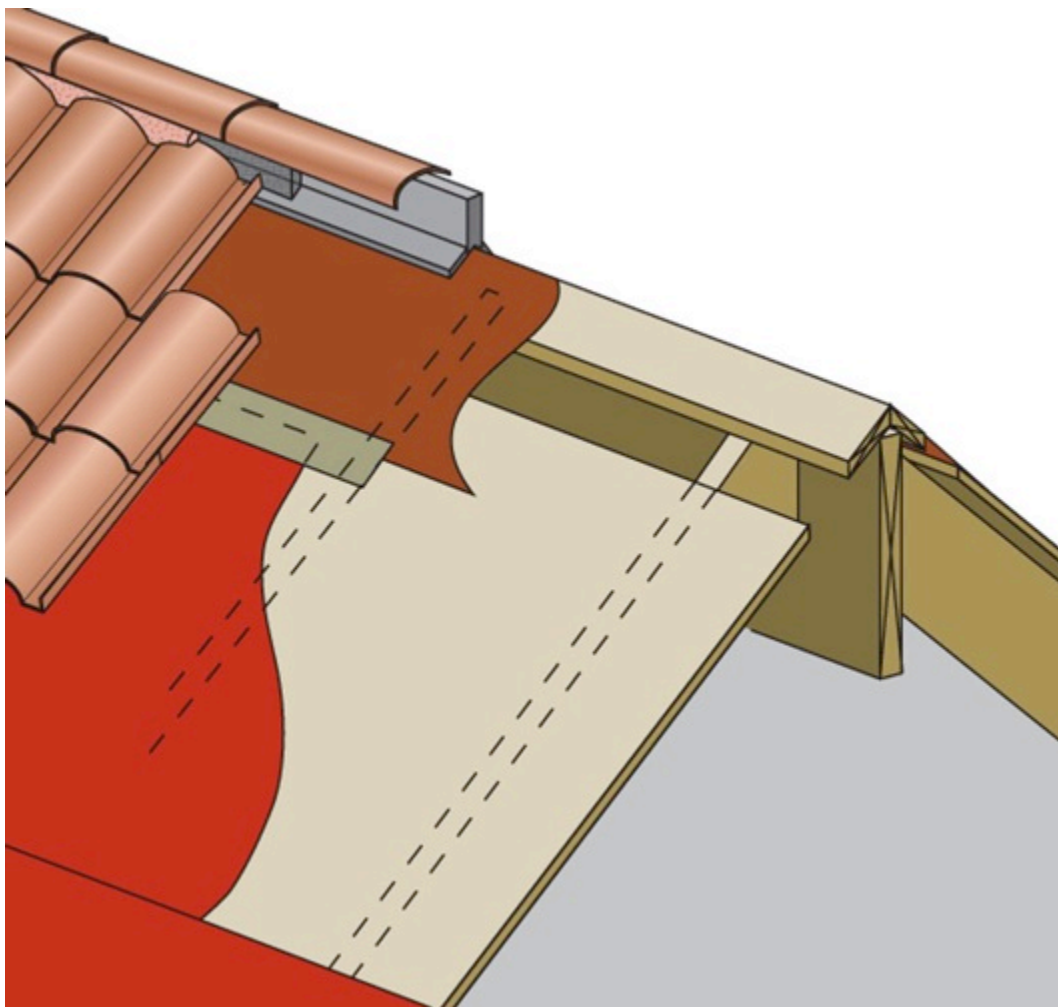











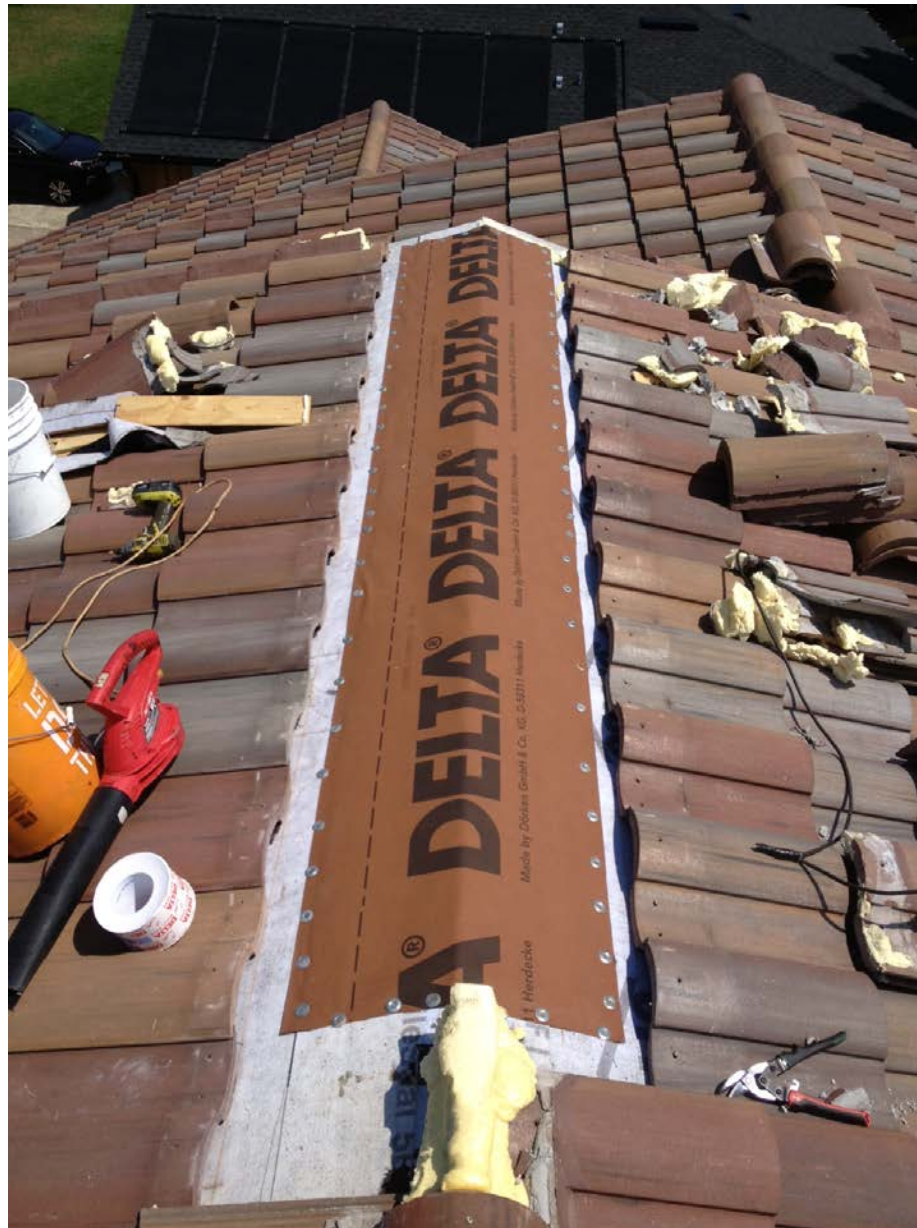











Sweating Ducts

Sweating Ducts

Light Colored Roofs

Cool Roofs

Radiant Barriers

ACCA Manual J, S and D

Ductwork Attic Dehumidification System

Burying Ducts

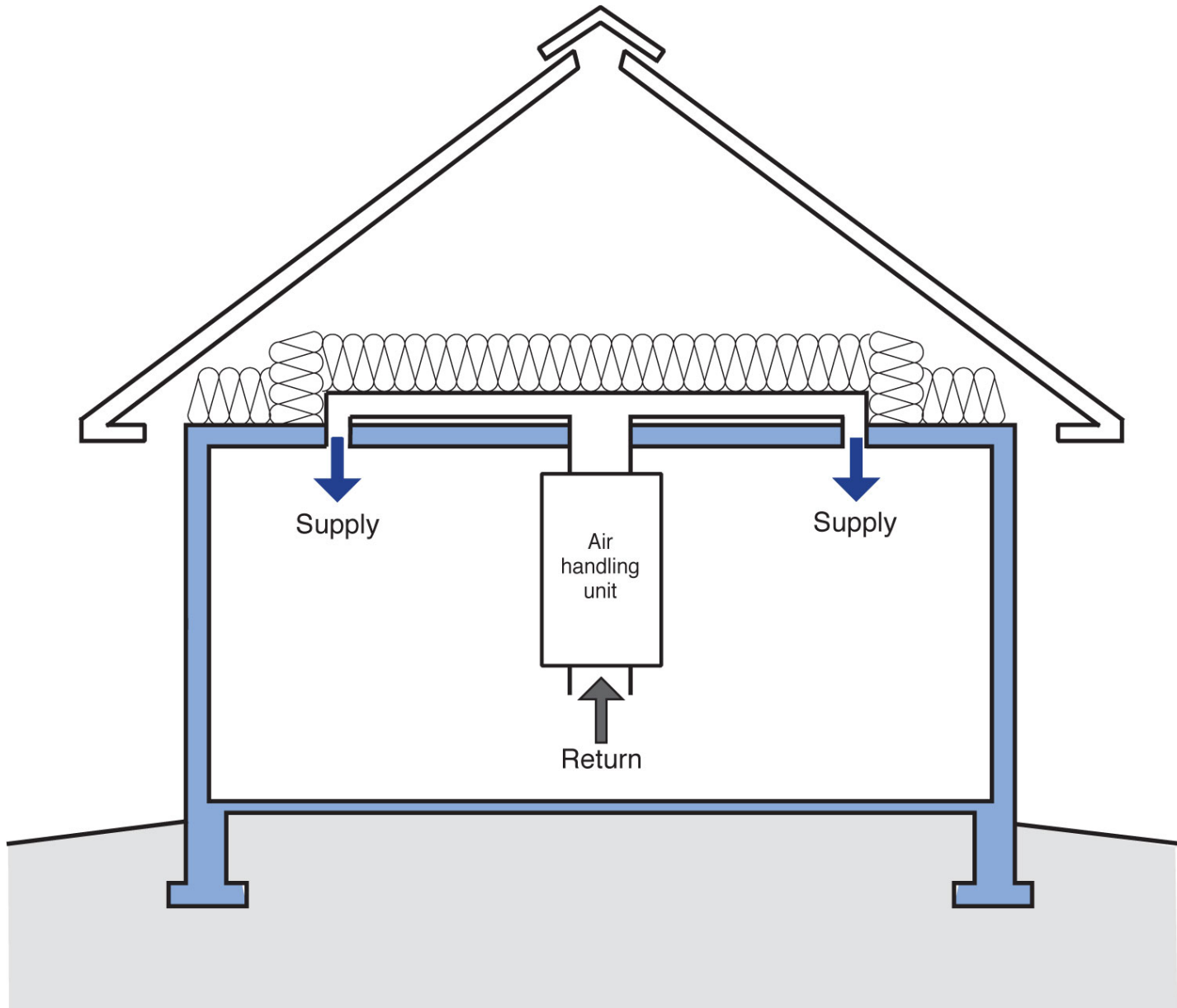

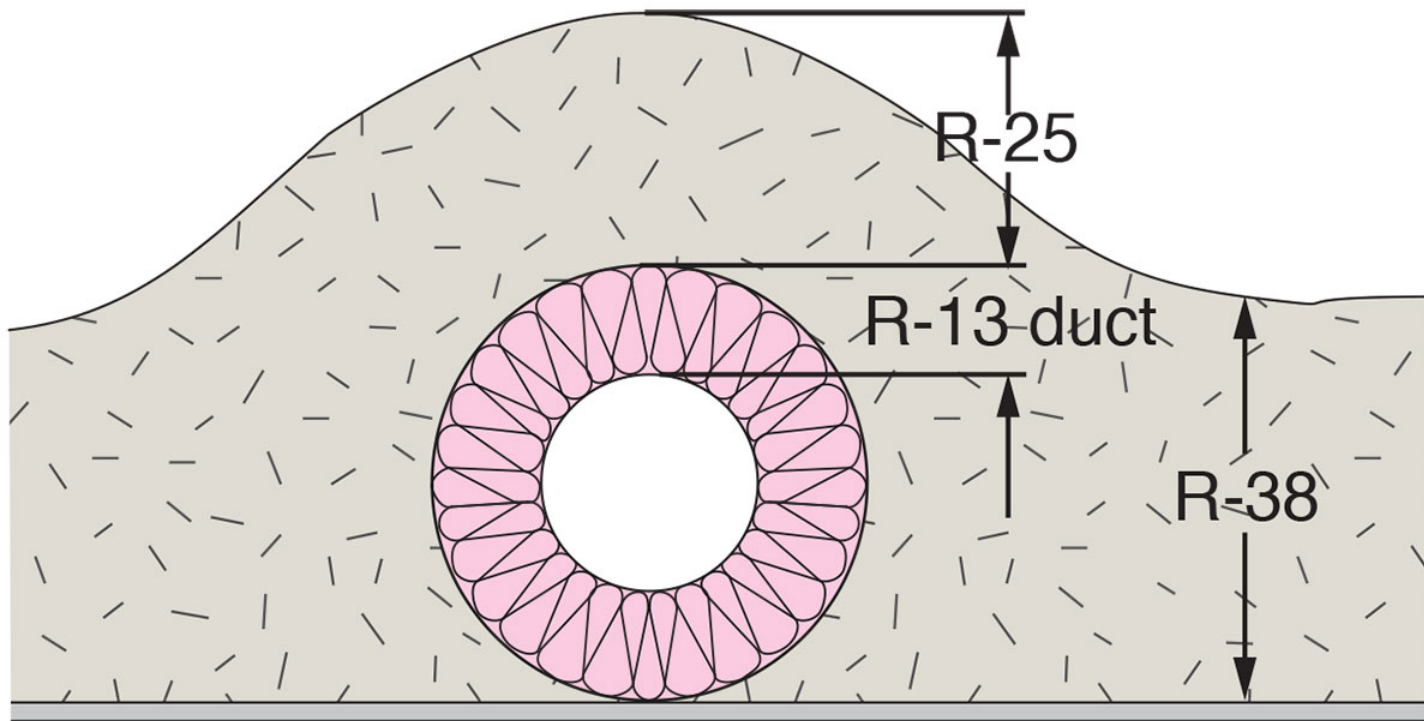







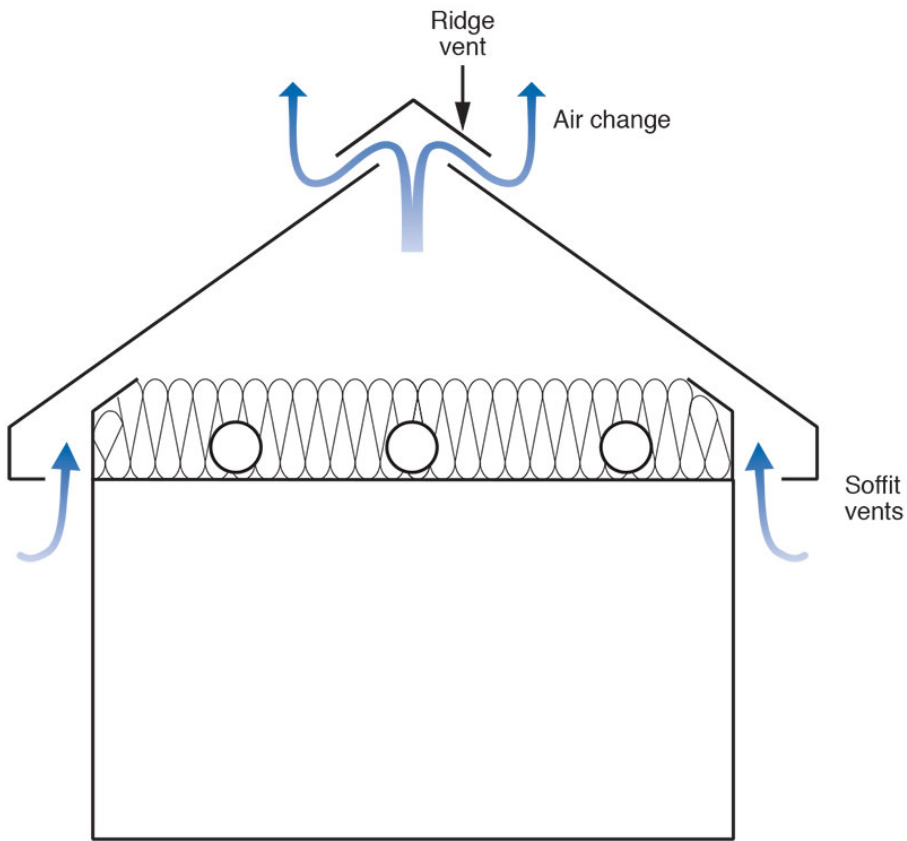

Classic vented attic

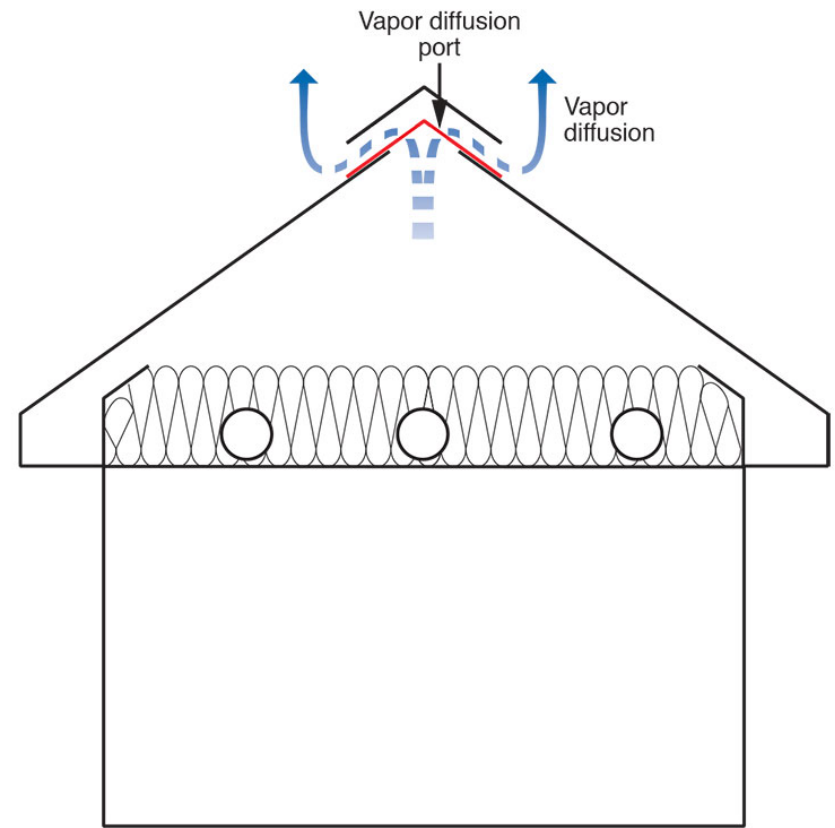

Unvented attic with vapor diffusion port

Cold Climates



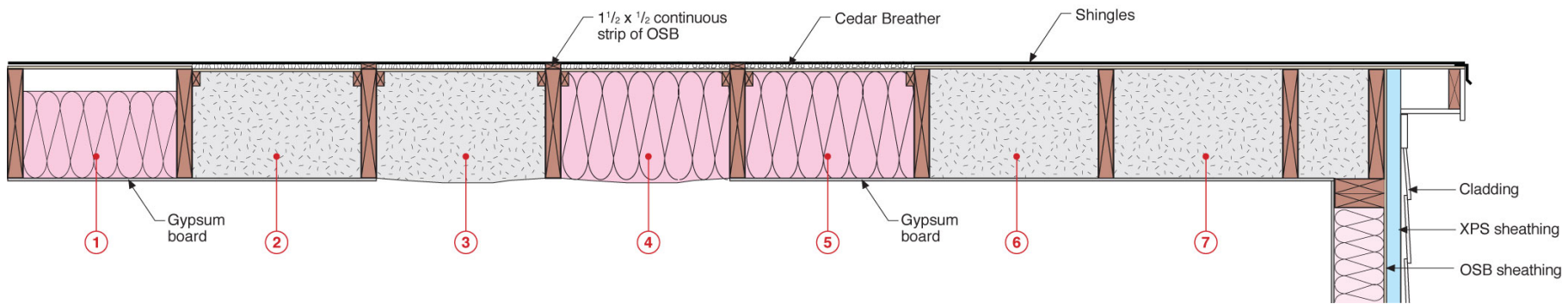











- Diffusion vent at ridge vs. no diffusion vent
- Fiberglass vs. cellulose
- Vapor retarder: variable perm vs. fixed perm
- “Control” comparison R806.4 spray foam + fibrous

