

Joseph Lstiburek, Ph.D, P.Eng, ASHRAE Fellow

Building Science

Adventures In Building Science

www.buildingscience.com

1

Ventilation In Houses

Building Science Corporation

Joseph Lstiburek 2

2

Build Tight - Ventilate Right

Building Science Corporation

Joseph Lstiburek 3

3

Build Tight - Ventilate Right

How Tight?

What's Right?

Building Science Corporation

Joseph Lstiburek 4

4

Air Barrier Metrics

Material 0.02 l/(s-m2) @ 75 Pa
 Assembly 0.20 l/(s-m2) @ 75 Pa
 Enclosure 2.00 l/(s-m2) @ 75 Pa
 0.25 cfm/ft2 @ 50 Pa

Building Science Corporation Joseph Lstiburek 5

5

Getting rid of big holes 3 ach@50
 Getting rid of smaller holes 1.5 ach@50
 Getting German 0.6 ach@50

Building Science Corporation Joseph Lstiburek 6

6

Best

As Tight as Possible - with -
 Balanced Ventilation
 Energy Recovery
 Distribution and Mixing
 Source Control - Spot exhaust ventilation
 Filtration
 Material selection

Building Science Corporation Joseph Lstiburek 7

7

Worst

Leaky - with – Nothing
 Spot Ventilation in Bathroom/Kitchen
 Exhaust Ventilation – with – No Distribution
 and No Mixing

Building Science Corporation Joseph Lstiburek 8

8

Three Types of Controlled Ventilation Systems

- Exhaust Ventilation
- Supply Ventilation
- Balanced Ventilation

Building Science Corporation

Joseph Lstiburek 9

9

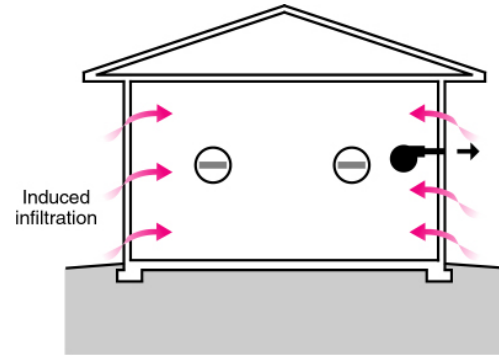

Building Science Corporation

Joseph Lstiburek 10

10

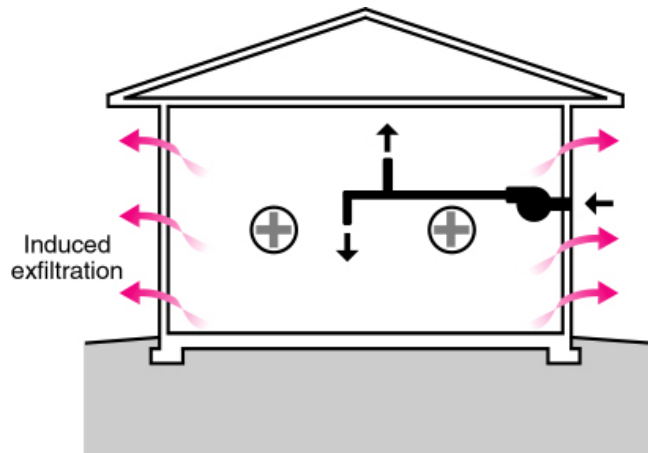

Building Science Corporation

Joseph Lstiburek 11

11

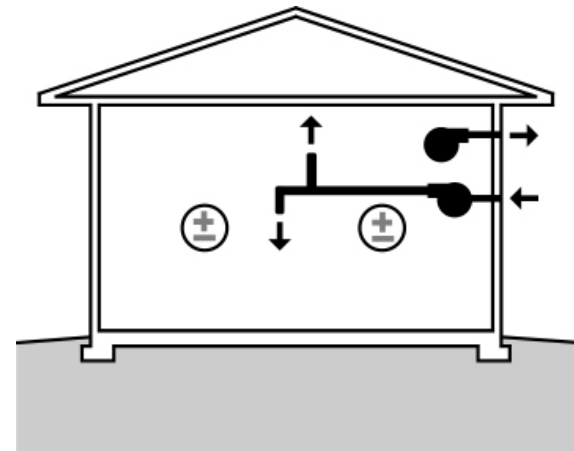

Building Science Corporation

Joseph Lstiburek 12

12

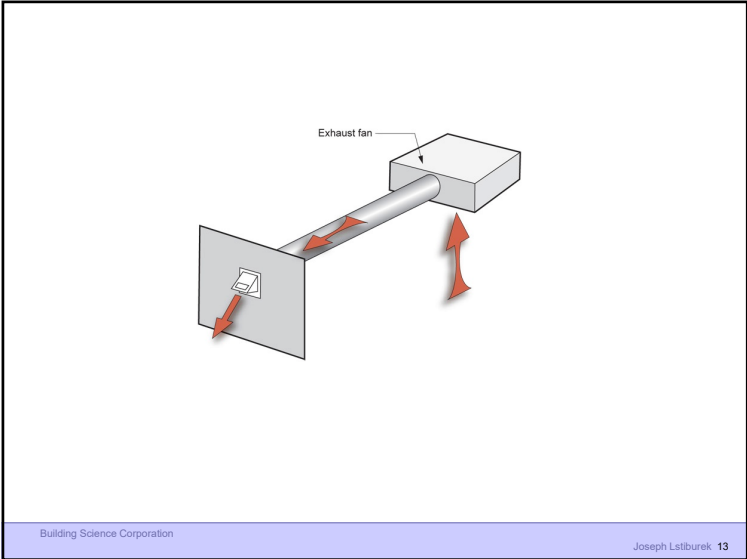

13

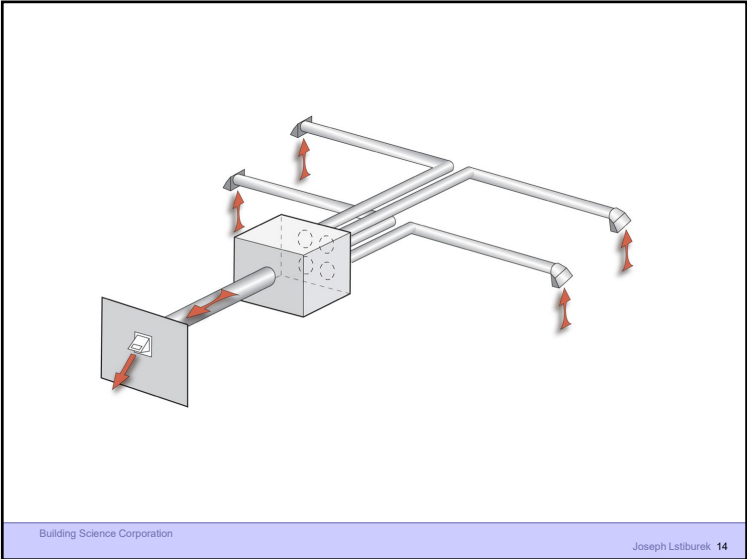

14

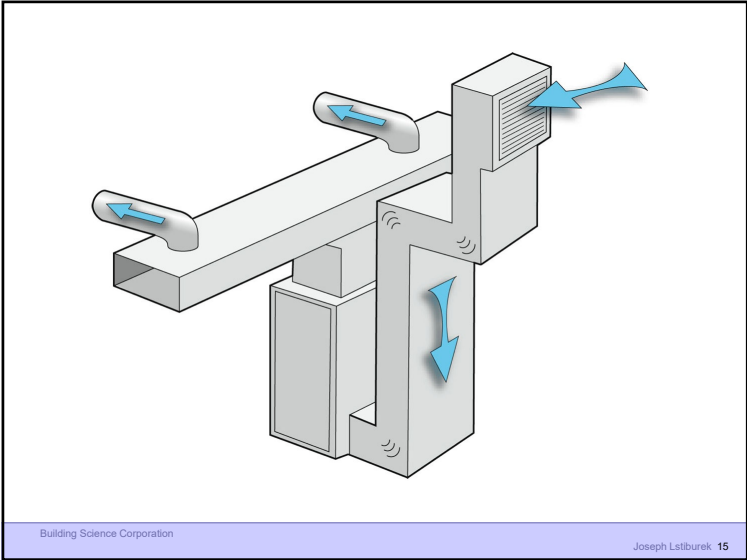

15

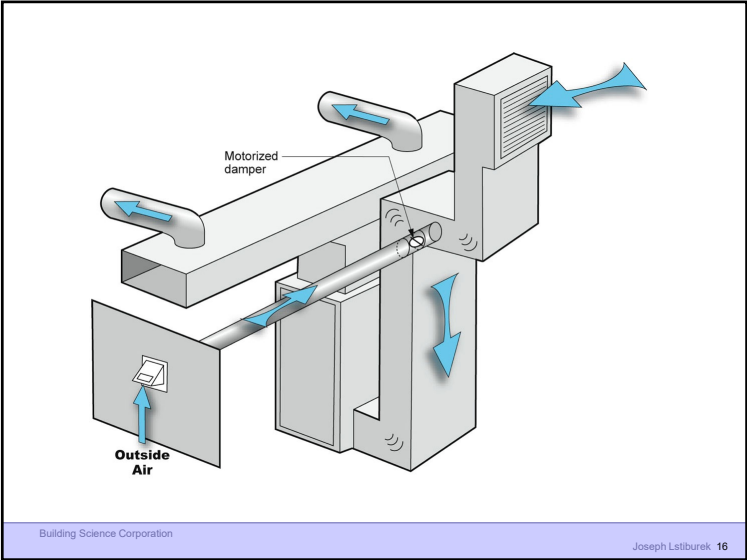

16

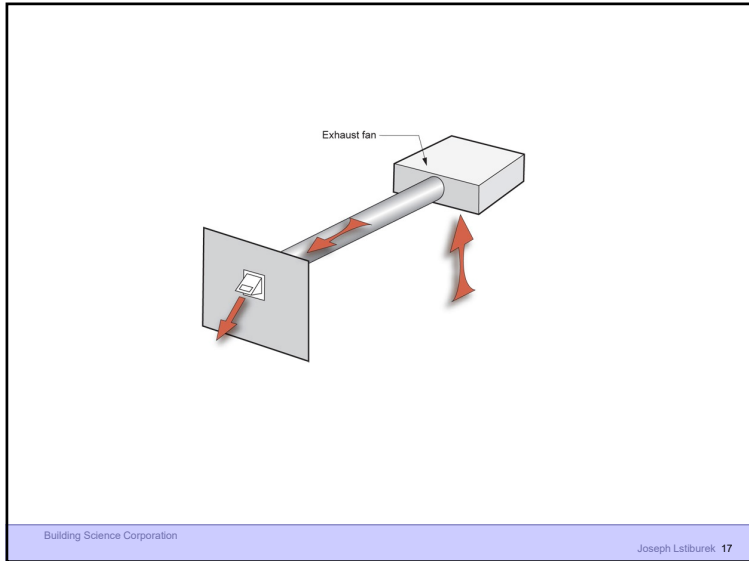

17

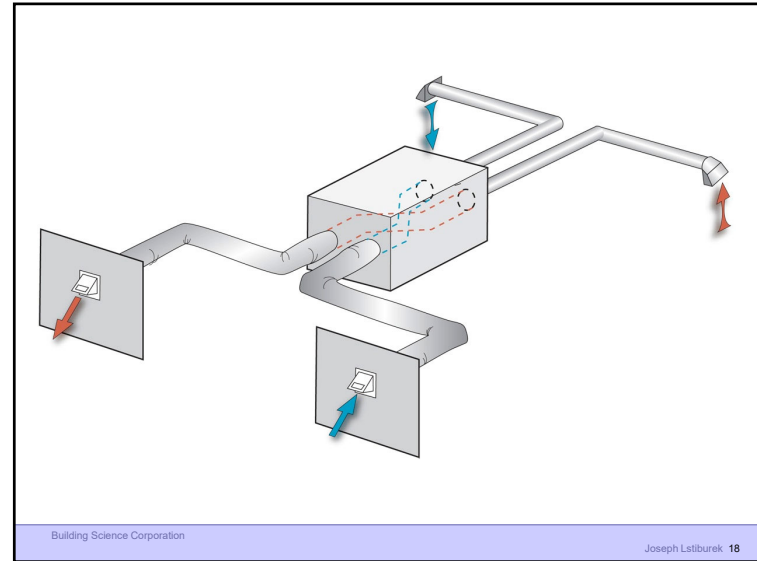

18

Ventilation Rates Are Based on Odor Control

Building Science Corporation Joseph Lstiburek 19

19

Ventilation Rates Are Based on Odor Control
Health Science Basis for Ventilation Rates is Extremely Limited

Building Science Corporation Joseph Lstiburek 20

20

Ventilation Rates Are Based on Odor Control
 Health Science Basis for Ventilation Rates is
 Extremely Limited
 Almost Nothing Cited Applies to Housing

21

Ventilation Rates Are Based on Odor Control
 Health Science Basis for Ventilation Rates is
 Extremely Limited
 Almost Nothing Cited Applies to Housing
 The Applicable Studies Focus on Dampness

22

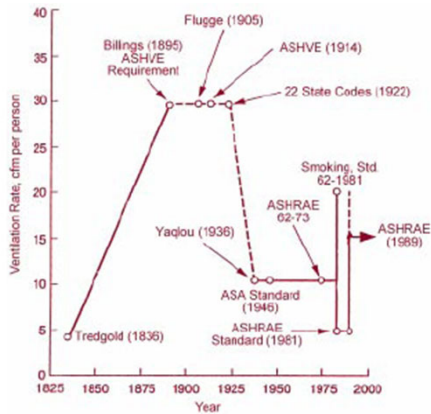

Figure 1: Minimum ventilating rate history.

23

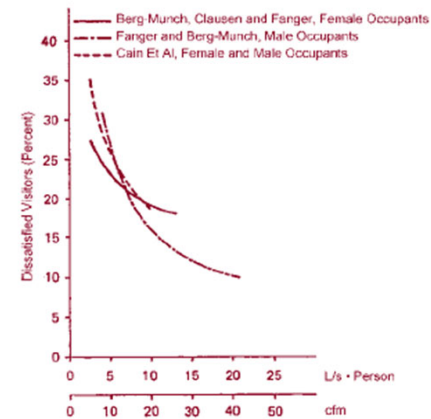

Figure 2: Odor acceptance.

24

House
 2,000 ft²
 3 bedrooms
 8 ft. ceiling
 Volume: 16,000 ft³

.35 ach	93 cfm
.30 ach	80 cfm
.25 ach	67 cfm
.20 ach	53 cfm
.15 ach	40 cfm

Building Science Corporation Joseph Lstiburek 25

25

House
 2,000 ft²
 3 bedrooms
 8 ft. ceiling
 Volume: 16,000 ft³

.35 ach	93 cfm	62 - 73	5 cfm/person	20 cfm
.30 ach	80 cfm		10 cfm/person	40 cfm
.25 ach	67 cfm	62 - 89	15 cfm/person	60 cfm
.20 ach	53 cfm		.35 ach	90 cfm
.15 ach	40 cfm	62.2 - 2010	7.5 cfm/person	50 cfm
			+ 0.01	
		62.2 - 2013	7.5 cfm/person	90 cfm
			+ 0.03	

Building Science Corporation Joseph Lstiburek 26

26

Office
Occupant Density

15/1000 ft ² (67 ft ² /person)	62 - 89
15 cfm/person	
5/1000 ft ² (200 ft ² /person)	62.1 - 2007
17 cfm/person	

Correctional Facility Cell
Occupant Density

20/1000 ft ² (48 ft ² /person)	62.1 - 2007
10 cfm/person	

Building Science Corporation Joseph Lstiburek 27

27

C.P. Yaglou
 Harvard School of Public Health
 1936
 1955

150 ft ³	→	20 cfm/person
300 ft ³	→	12 cfm/person

Building Science Corporation Joseph Lstiburek 28

28

C.P. Yaglou
 Harvard School of Public Health
 1936
 1955

150 ft³ → 20 cfm/person 18.75 ft² 106 occupants
 300 ft³ → 12 cfm/person 37.5 ft² 53 occupants

Experiment

470 ft³ → 59 ft²
 200 ft³ → 25 ft²
 100 ft³ → 12 ft²

29

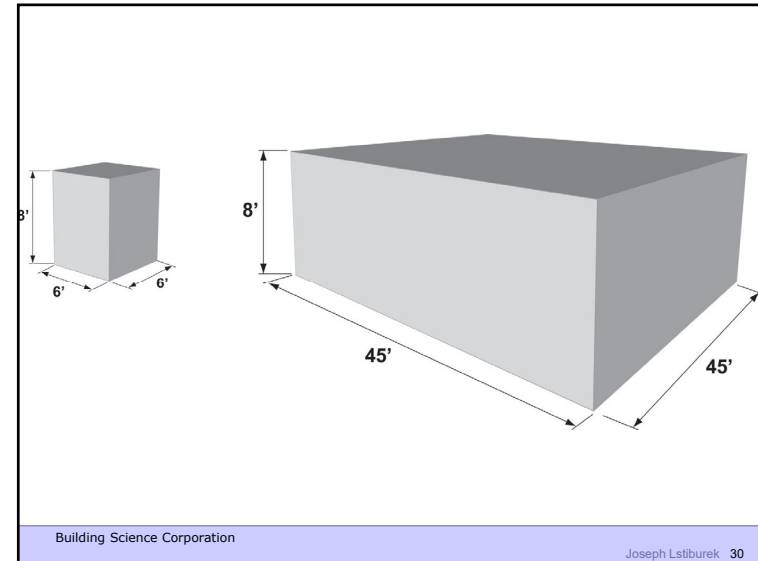

30

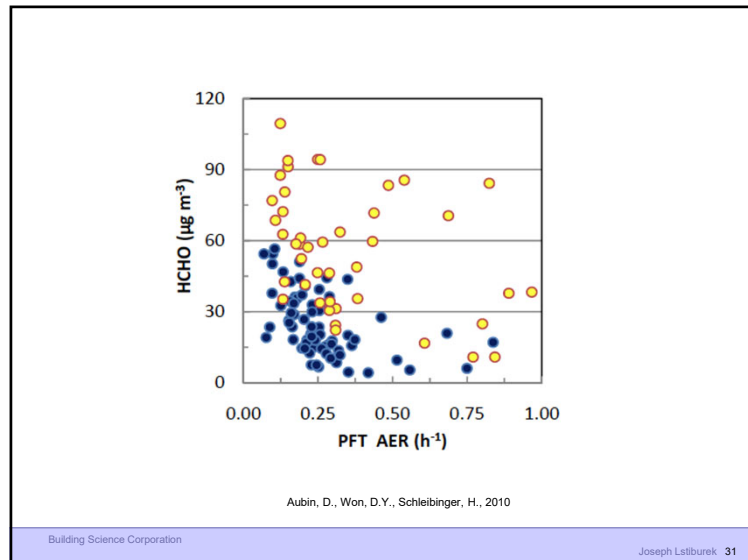

31

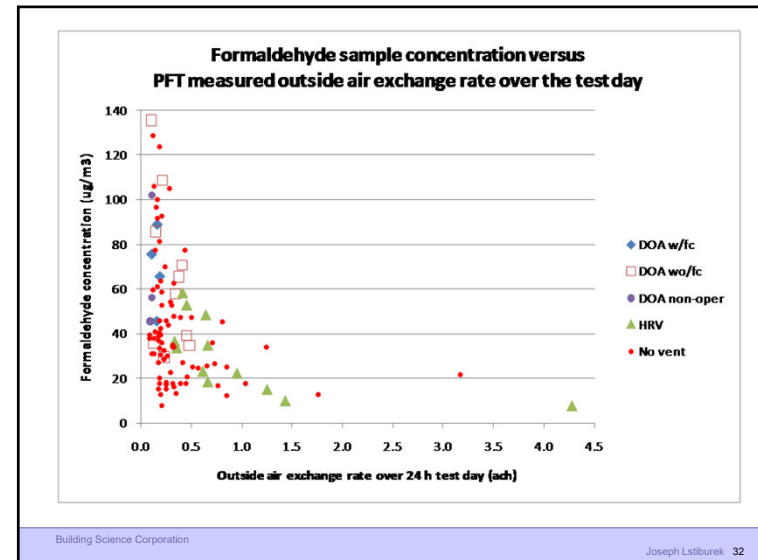

32

ASHRAE Standard 62.2 calls for 7.5 cfm per person plus 0.03 cfm per square foot of conditioned area

Occupancy is deemed to be the number of bedrooms plus one

Building Science Corporation Joseph Lstiburek 33

33

ASHRAE Standard 62.2 calls for 7.5 cfm per person plus 0.03 cfm per square foot of conditioned area

Occupancy is deemed to be the number of bedrooms plus one

Outcome is often bad – part load humidity problems, dryness problems, energy problems

Building Science Corporation Joseph Lstiburek 34

34

IRC 2015 and 2018 calls for 7.5 cfm per person plus 0.01 cfm per square foot of conditioned area

Occupancy is deemed to be the number of bedrooms plus one

Building Science Corporation Joseph Lstiburek 35

35

3 Bedroom House – 2,500 ft²

30 cfm plus 75 cfm

105 cfm

Building Science Corporation Joseph Lstiburek 36

36

3 Bedroom House – 2,500 ft²
30 cfm plus 25 cfm
55 cfm

Building Science Corporation Joseph Lstiburek 37

37

3 Bedroom House – 2,500 ft²
30 cfm plus 25 cfm
55 cfm
With Balanced and Distributed 30 percent credit
38.5 cfm

Building Science Corporation Joseph Lstiburek 38

38

The Cult of The Blower Door

Building Science Corporation Joseph Lstiburek 39

39



Building Science Corporation Joseph Lstiburek 40

40

Blower Door Can't Get You The True ACH
On A Short Term Basis – Hour, Day, Week

Building Science Corporation Joseph Lstiburek 41

41

Don't Know Where The Holes Are
Don't Know The Type of Holes
Don't Know The Pressure Across The Holes

Building Science Corporation Joseph Lstiburek 42

42

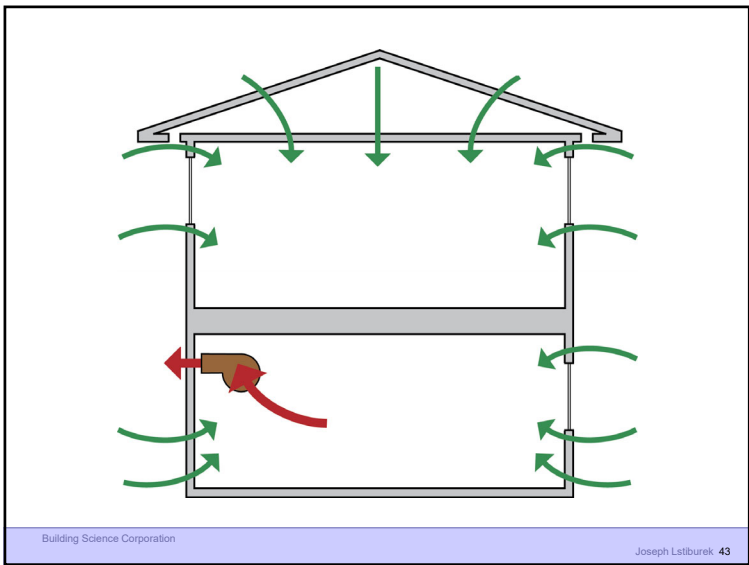

43

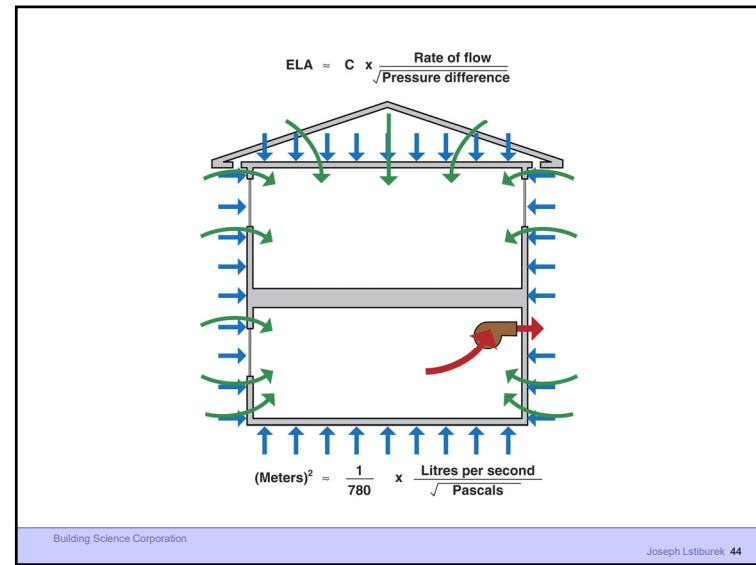

44

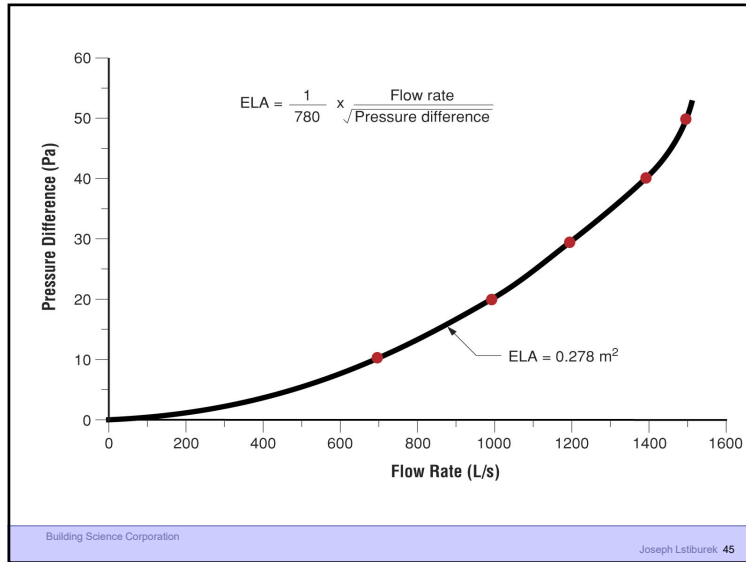

45

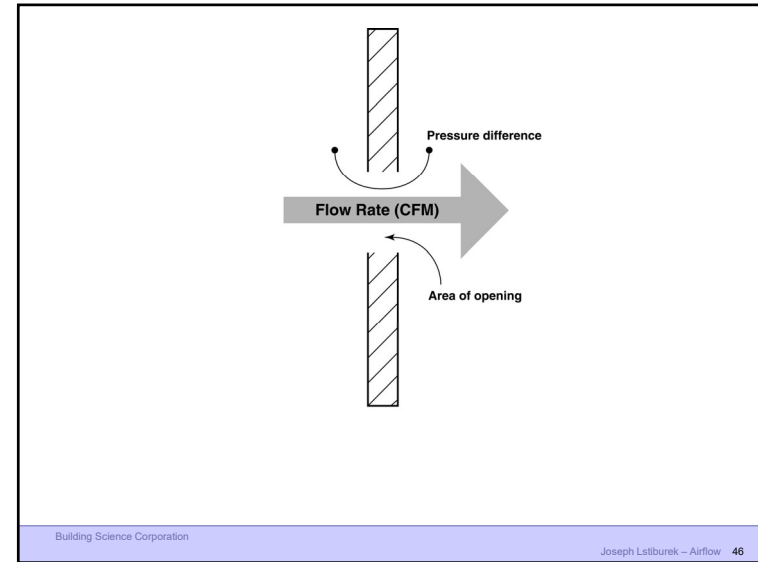

46

Flow Through Orifices
 Turbulent Flow - "inertial effects"

Flow Through Porous Media
 Laminar Flow - "viscosity effects"

47

Flow Through Orifices
 Turbulent Flow - "inertial effects"

Flow Through Porous Media
 Laminar Flow - "viscosity effects"

"true but not useful"

48

$$Q = A \cdot C_D \left[\frac{2}{\rho} (\Delta P) \right]^{\frac{1}{2}} \quad \text{Bernoulli}$$

$$Q = C_K \frac{\rho}{\mu} (\Delta P) \quad \text{Darcy}$$

Building Science Corporation Joseph Lstiburek – Airflow 49

49

$$Q = A \cdot C_D \left[\frac{2}{\rho} (\Delta P) \right]^{\frac{1}{2}} \quad \text{Bernoulli}$$

$$Q = C_K \frac{\rho}{\mu} (\Delta P) \quad \text{Darcy}$$

$$Q = A \cdot C (\Delta P)^{\frac{1}{2}}$$

$$Q = C (\Delta P)$$

Building Science Corporation Joseph Lstiburek – Airflow 50

50

$$Q = A \cdot C_D \left[\frac{2}{\rho} (\Delta P) \right]^{\frac{1}{2}} \quad \text{Bernoulli}$$

$$Q = C_K \frac{\rho}{\mu} (\Delta P) \quad \text{Darcy}$$

$$Q = A \cdot C (\Delta P)^{\frac{1}{2}}$$

$$Q = C (\Delta P)$$

$$Q = A \cdot C (\Delta P)^n \quad \text{Kronval "an engineer"}$$

Building Science Corporation Joseph Lstiburek – Airflow 51

51

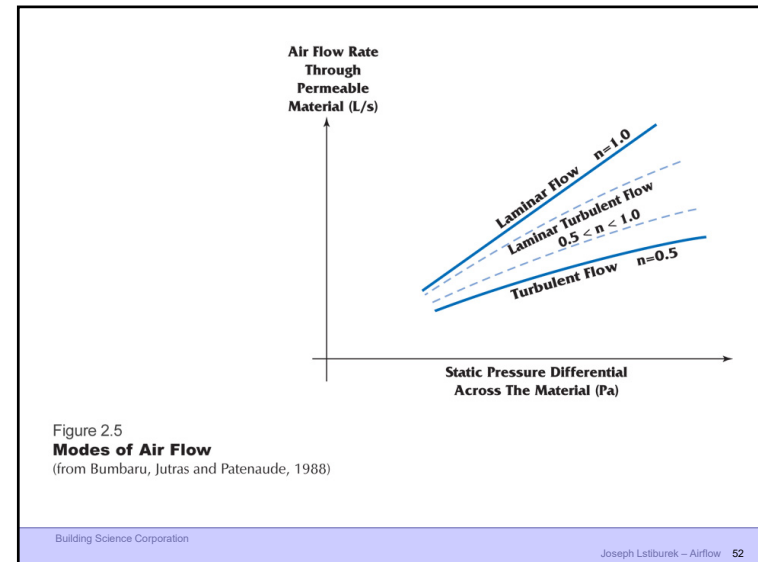

52

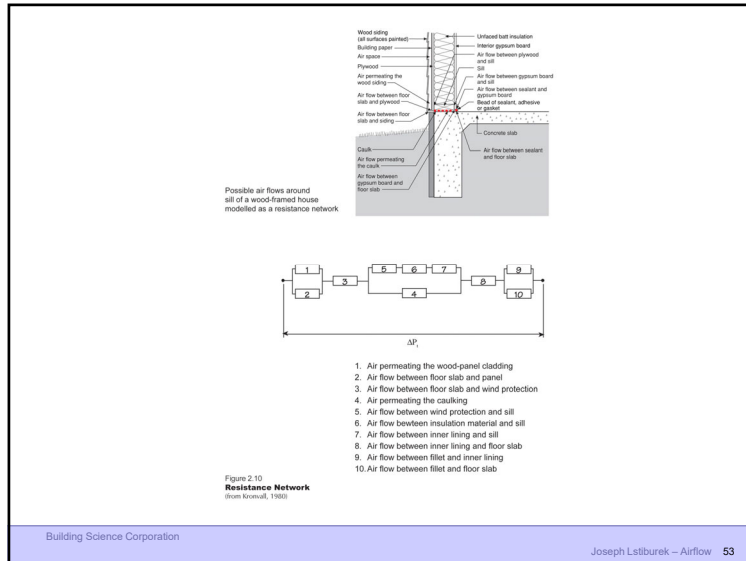

53

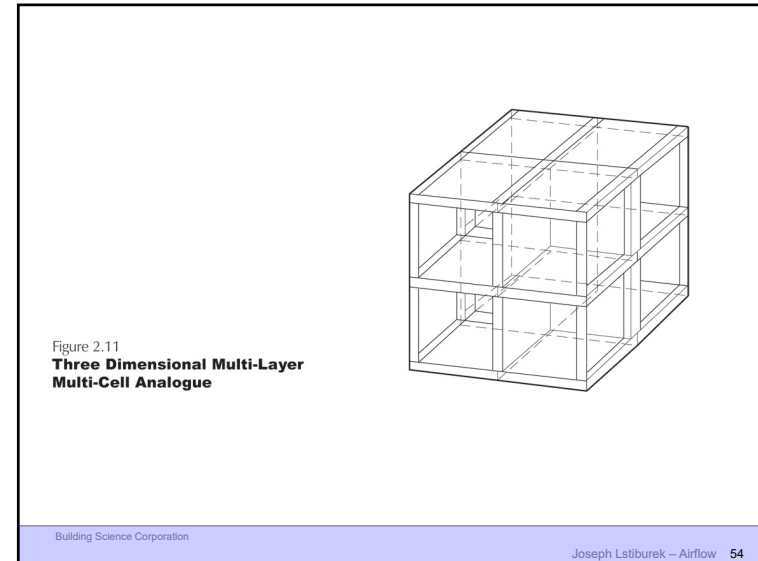

54

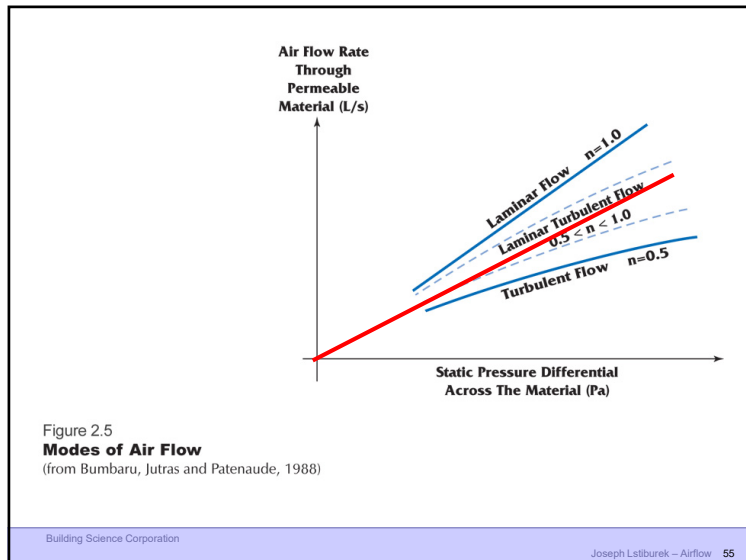

55

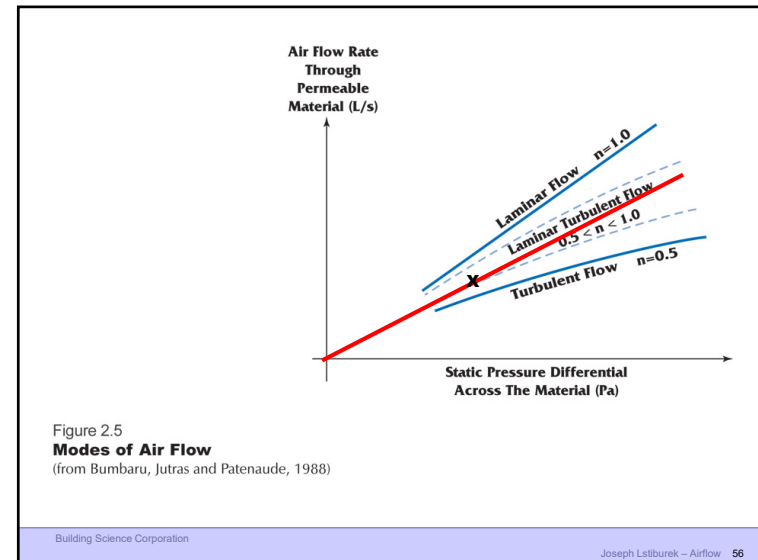

56

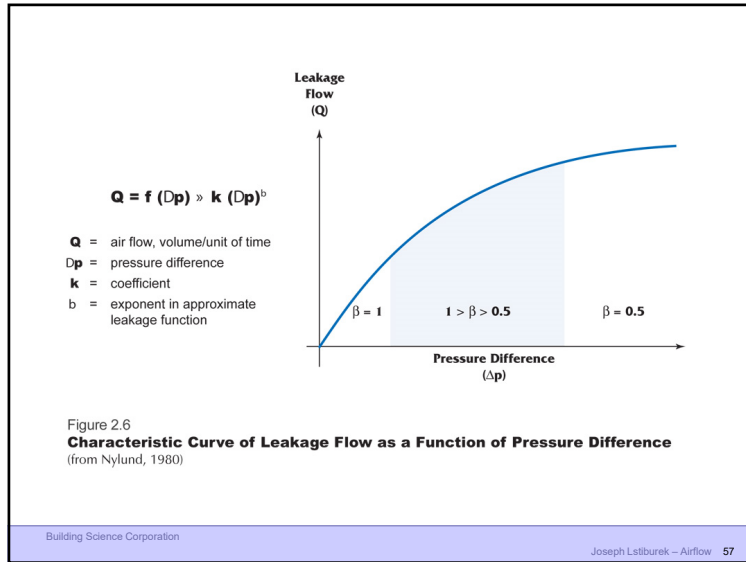

57

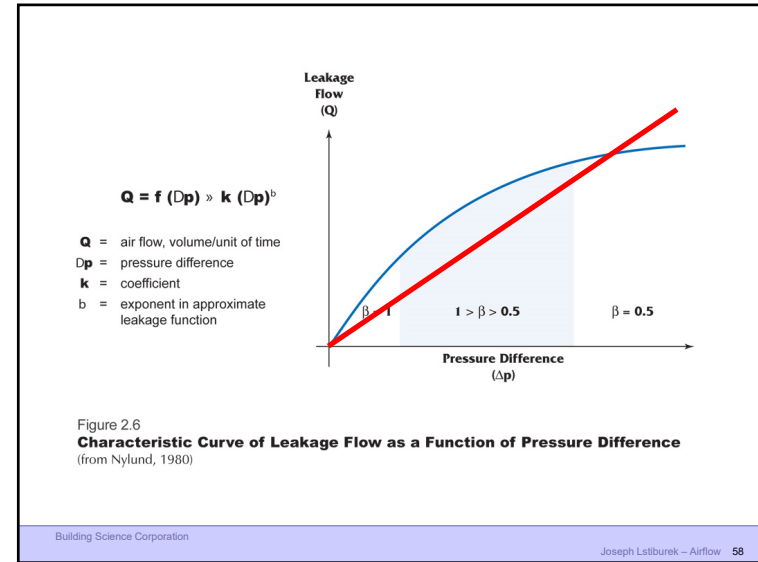

58

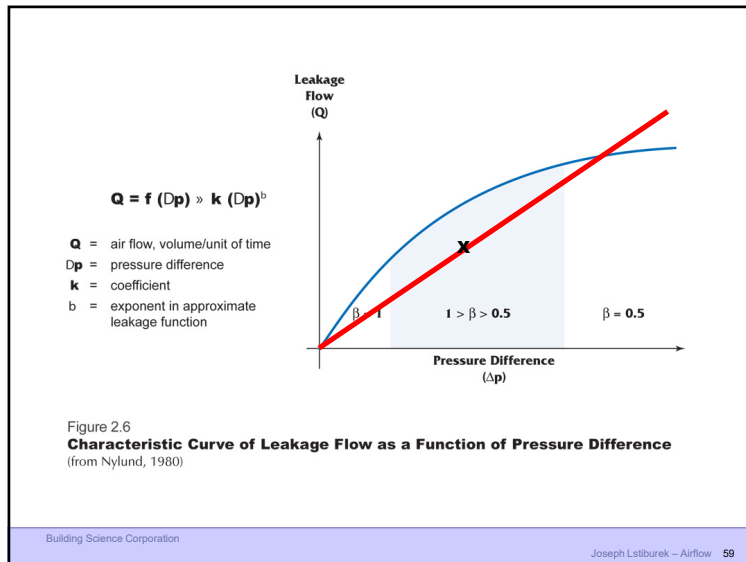

59

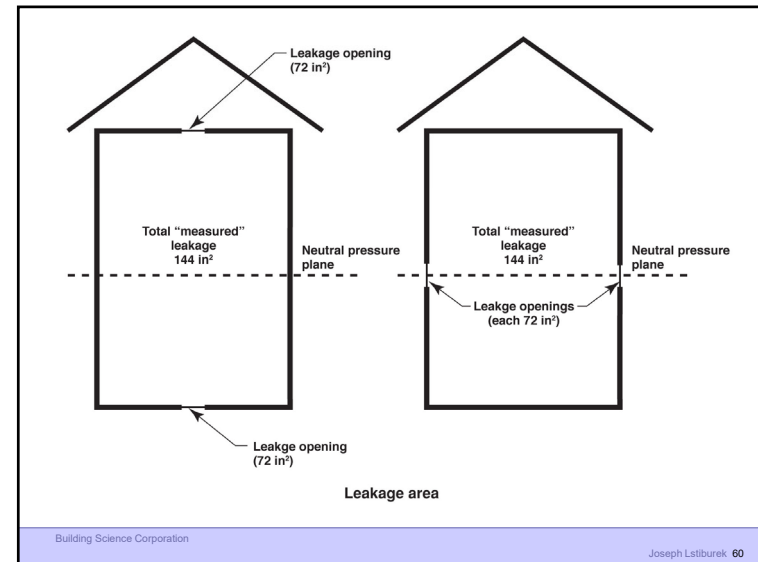

60

Dilution Is Not The Solution To Indoor
Pollution
Source Control

Building Science Corporation Joseph Lstiburek 61

61

Dilution For People
Source Control For The Building

Building Science Corporation Joseph Lstiburek 62

62

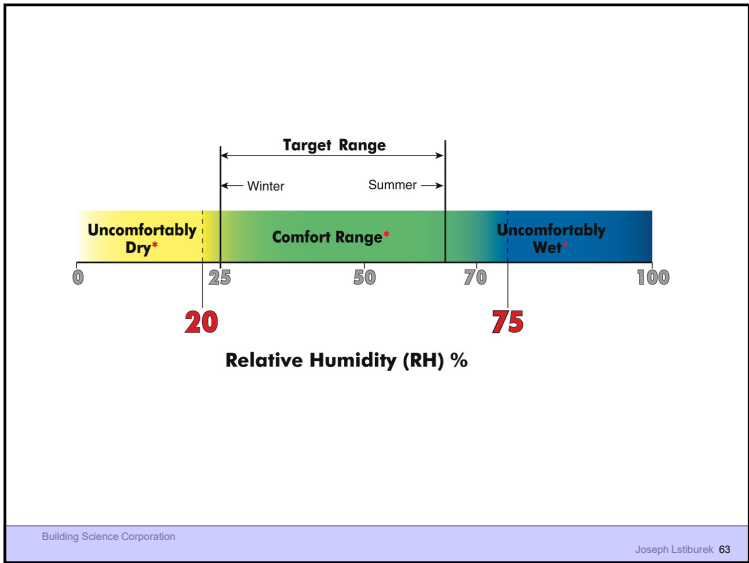

63

Recommended Range of Relative Humidity
Above 25 percent during winter
Below 70 percent during summer

Building Science Corporation Joseph Lstiburek 64

64

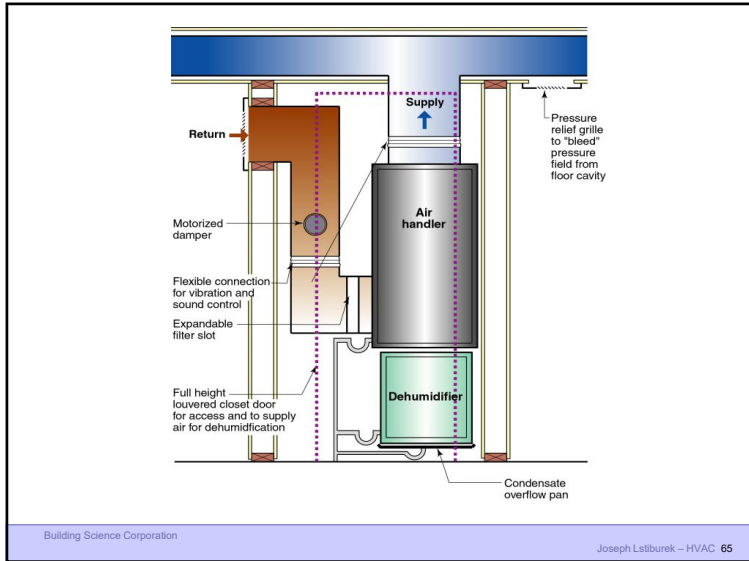

65



66

Kitchen Exhaust Hoods

Building Science Corporation

Joseph Lstiburek 67

67

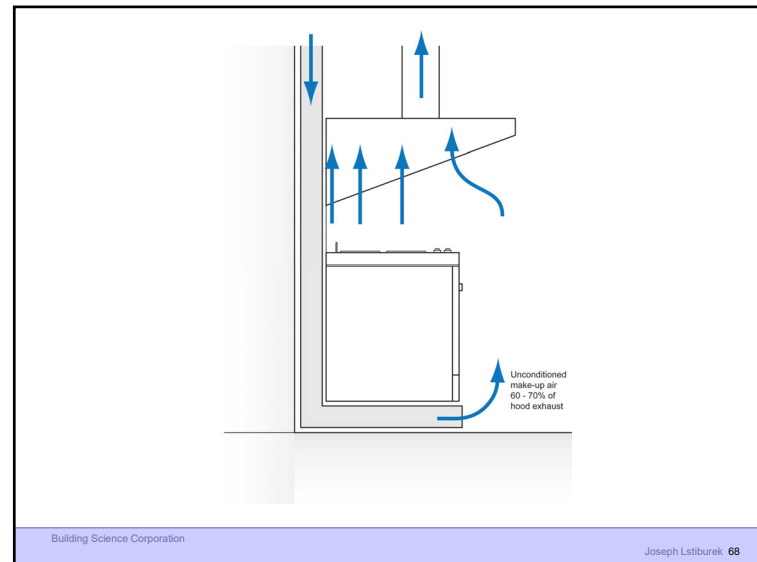

68



69

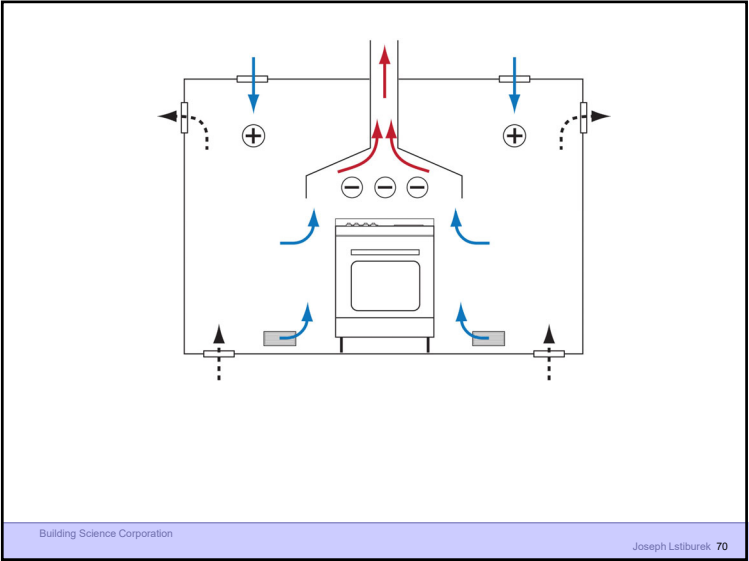

70

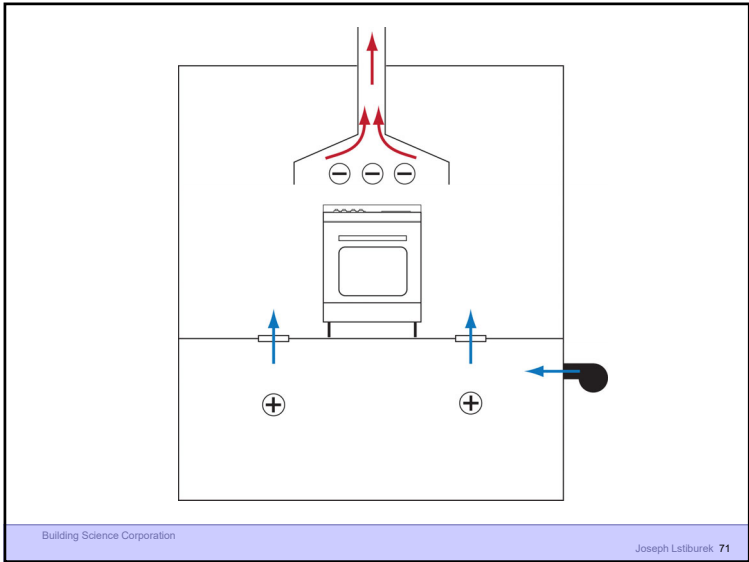

71

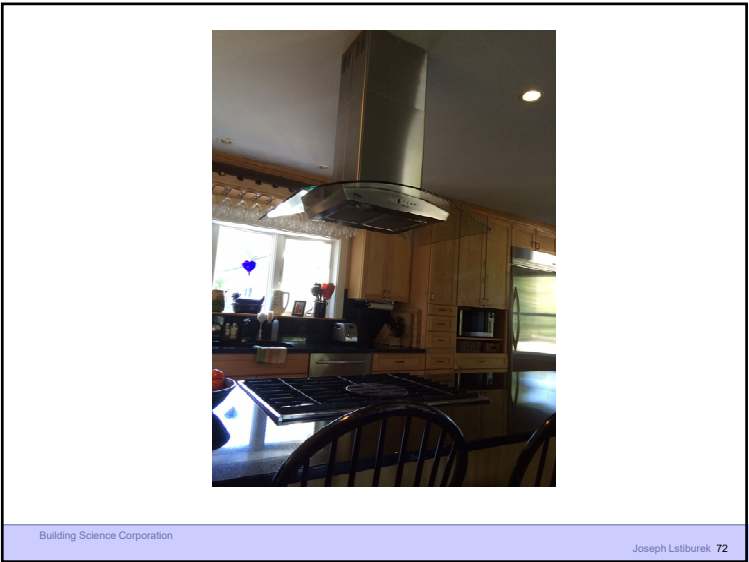

72

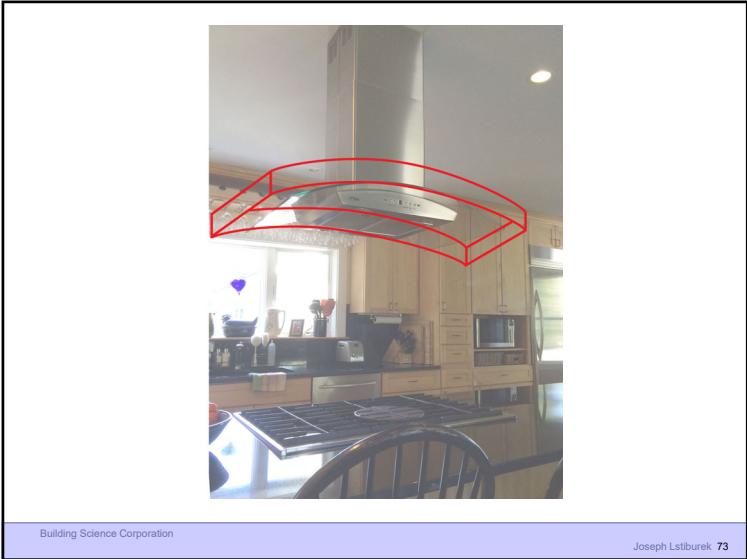

Building Science Corporation

Joseph Lstiburek 73

73

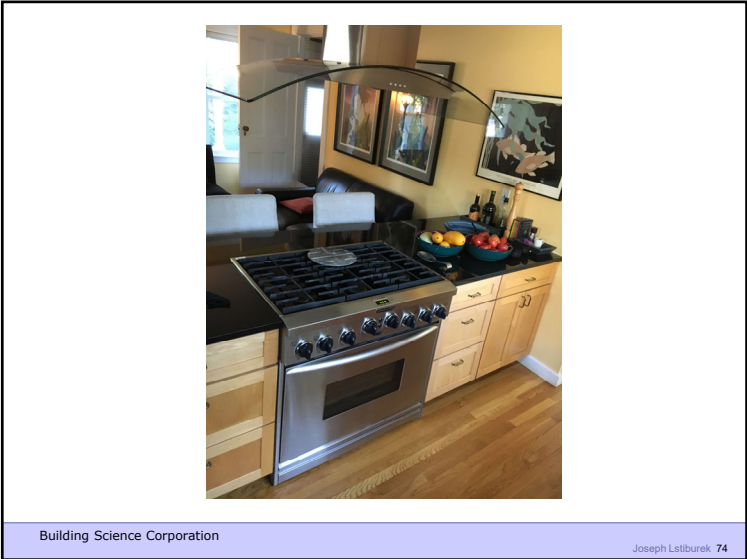

Building Science Corporation

Joseph Lstiburek 74

74

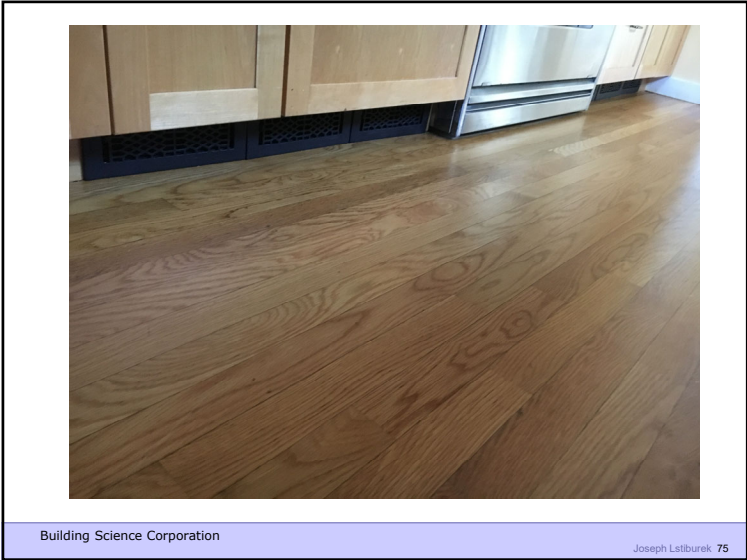

Building Science Corporation

Joseph Lstiburek 75

75

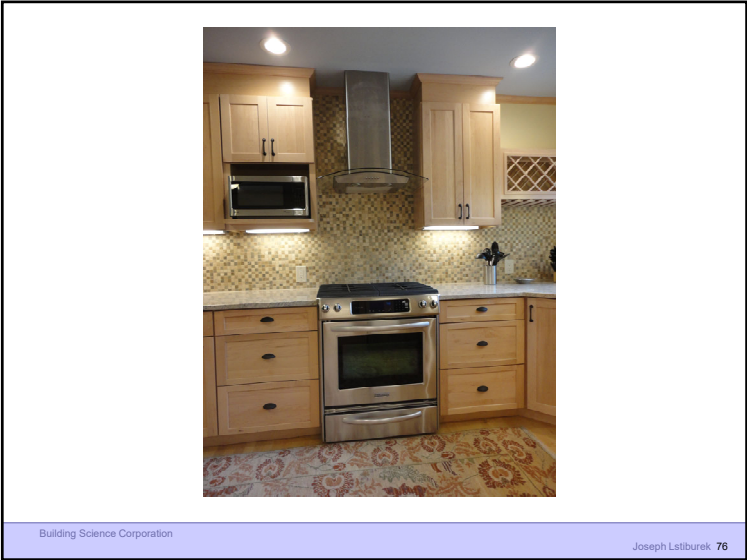

Building Science Corporation

Joseph Lstiburek 76

76

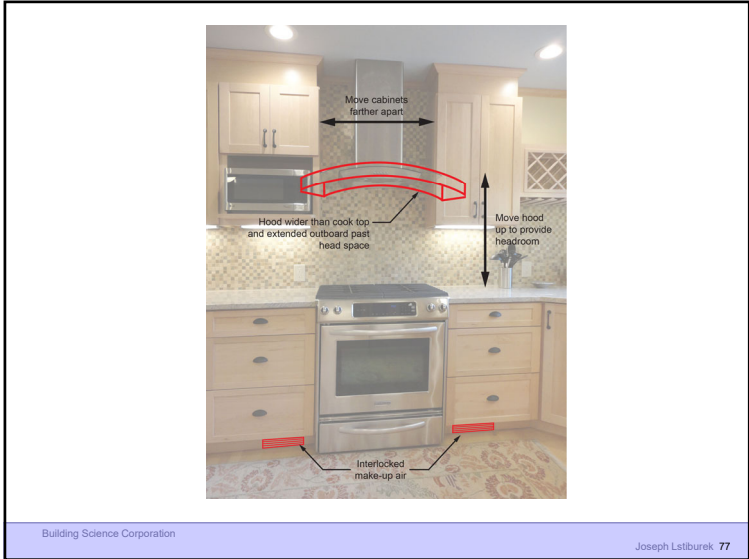

77



78



79

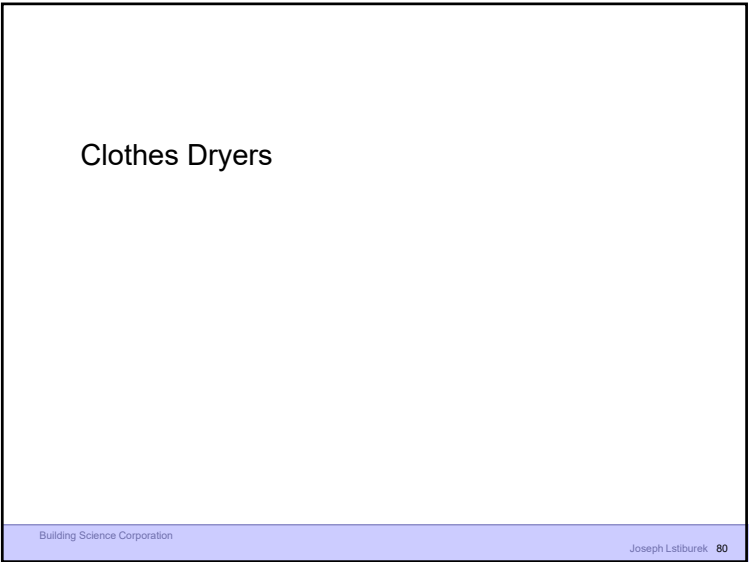

80



Building Science Corporation

Joseph Lstiburek 81

81



Building Science Corporation

Joseph Lstiburek 82

82



Building Science Corporation

Joseph Lstiburek 83

83



Building Science Corporation

Joseph Lstiburek 84

84

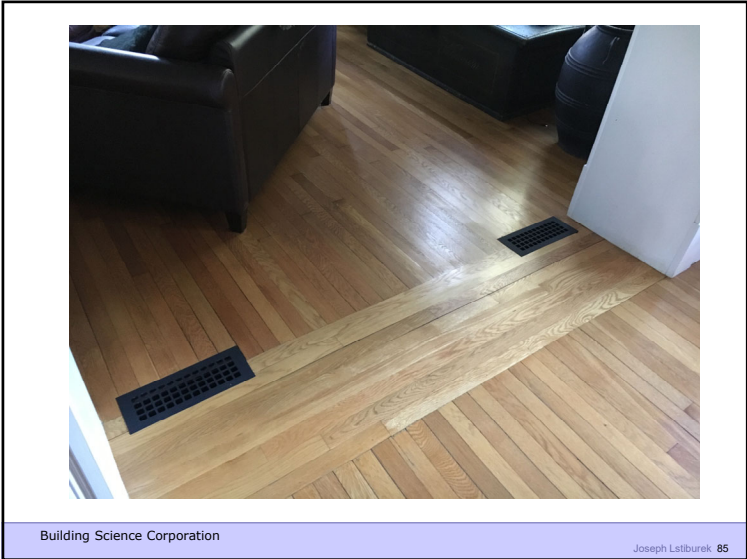

85

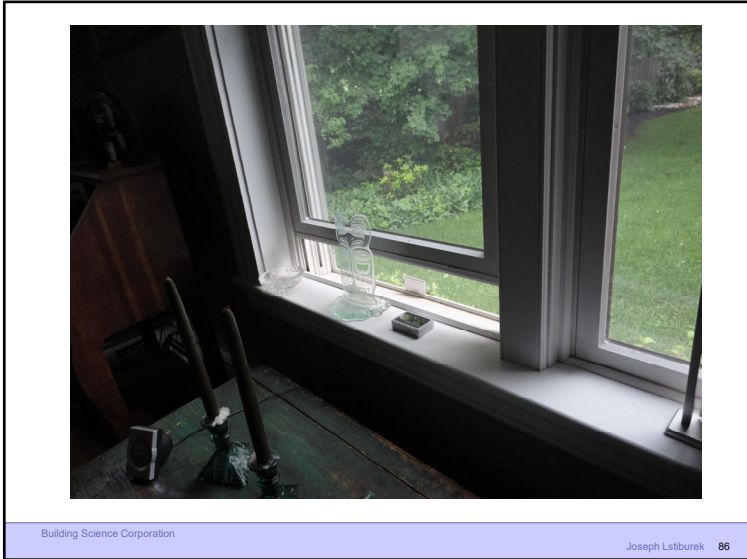

86



87

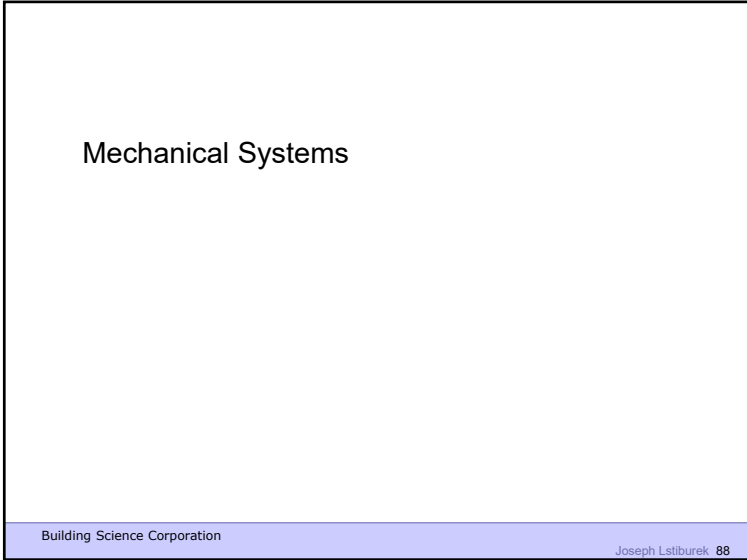

88

Mechanical Systems
Cooling System To Make It Cold

Building Science Corporation Joseph Lstiburek 89

89

Mechanical Systems
Cooling System To Make It Cold
Dehumidification System To Make It Dry

Building Science Corporation Joseph Lstiburek 90

90

Mechanical Systems
Cooling System To Make It Cold
Dehumidification System To Make It Dry
Heating System To Make It Warm

Building Science Corporation Joseph Lstiburek 91

91

Mechanical Systems
Cooling System To Make It Cold
Dehumidification System To Make It Dry
Heating System To Make It Warm
Energy Recovery System To Keep It Cold
and Dry and Warm and Comfortable

Building Science Corporation Joseph Lstiburek 92

92

Mechanical Systems
Cooling System To Make It Cold
Dehumidification System To Make It Dry
Heating System To Make It Warm
Energy Recovery System To Keep It Cold
and Dry and Warm and Comfortable
Distribution System To Make It Uniform

Building Science Corporation Joseph Lstiburek 93

93

Mechanical Systems
Cooling System To Make It Cold
Dehumidification System To Make It Dry
Heating System To Make It Warm
Energy Recovery System To Keep It Cold
and Dry and Warm and Comfortable
Distribution System To Make It Uniform
Range Hoods Are A Special Kind of Hell

Building Science Corporation Joseph Lstiburek 94

94

The Best Approach is Not to Combine
Them.....

Building Science Corporation Joseph Lstiburek 95

95

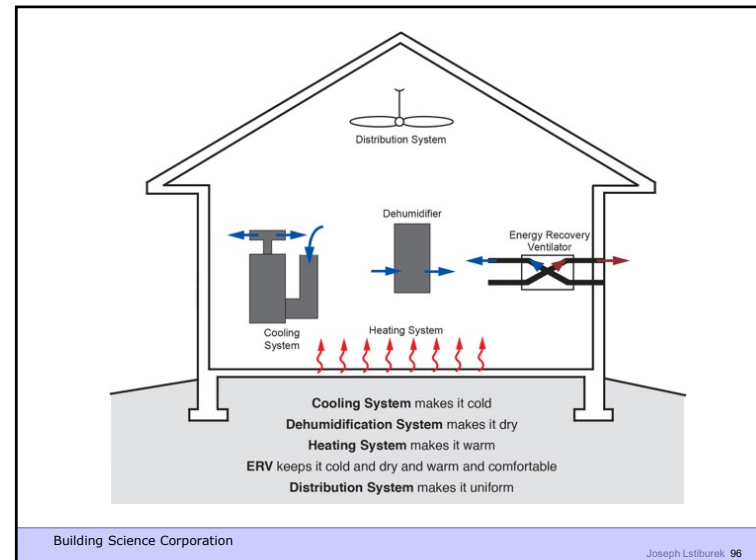

96

Approaches

Building Science Corporation Joseph Lstiburek 97

97

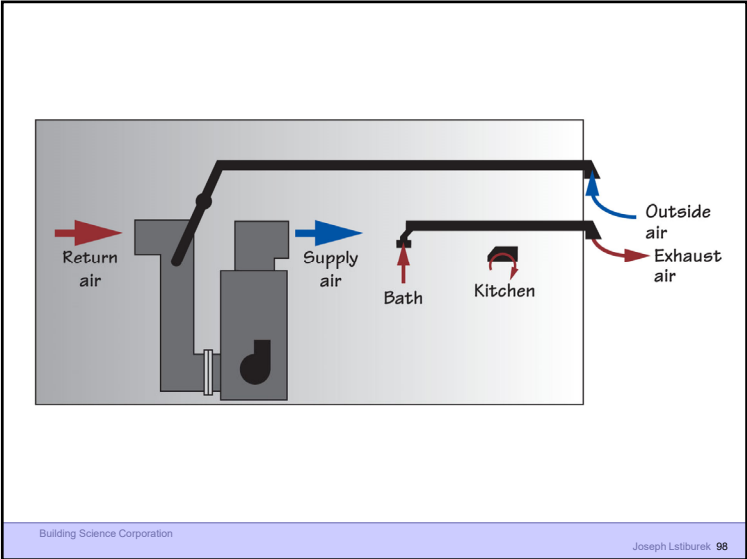

98

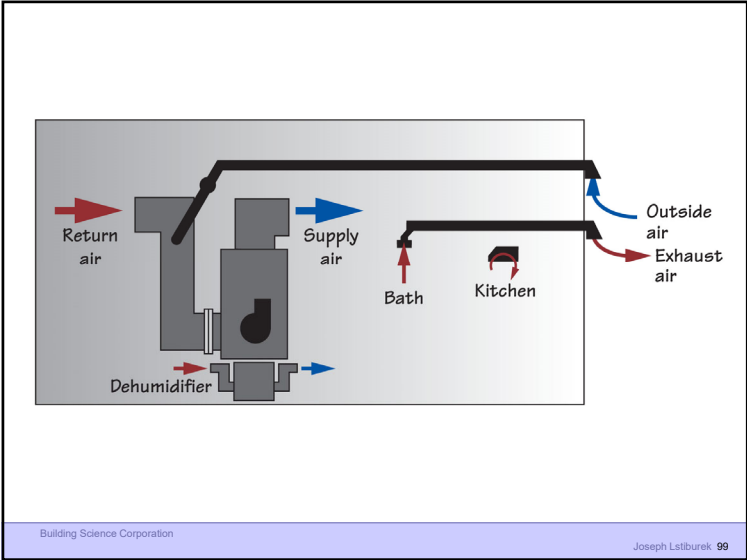

99

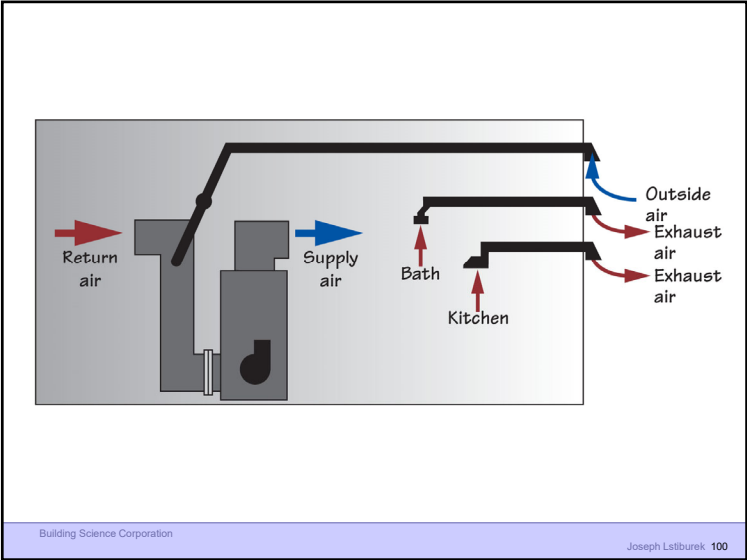

100

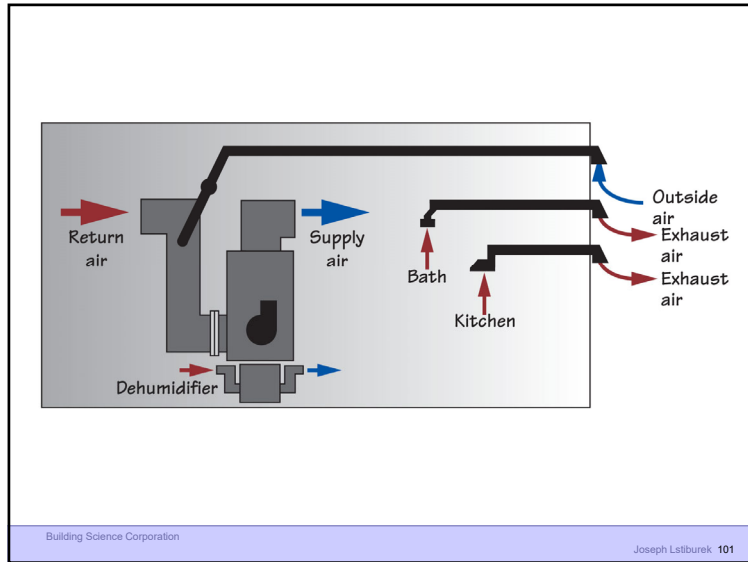

101

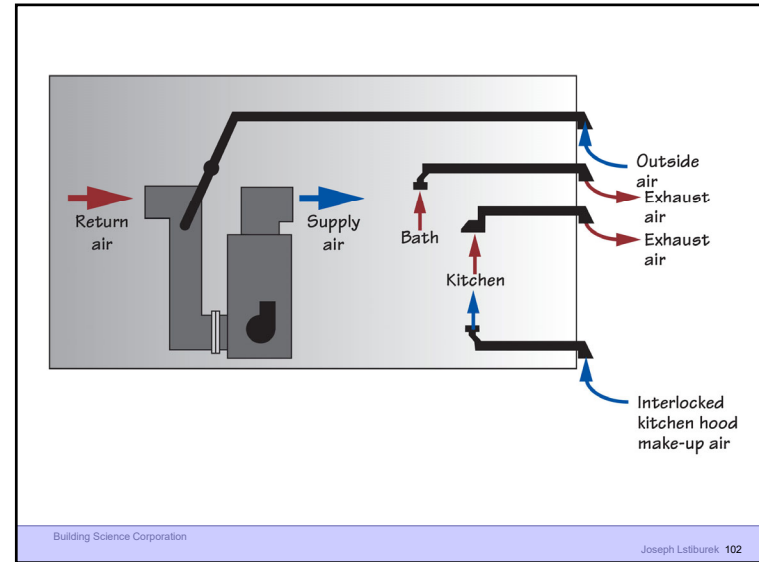

102

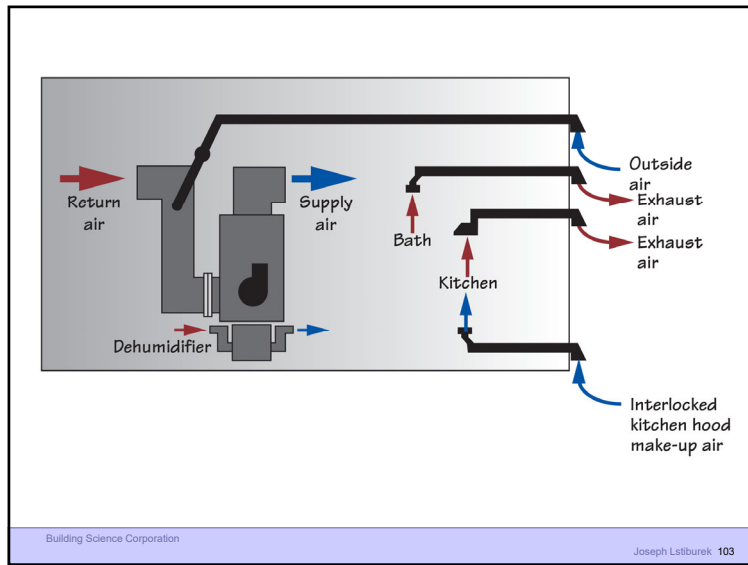

103

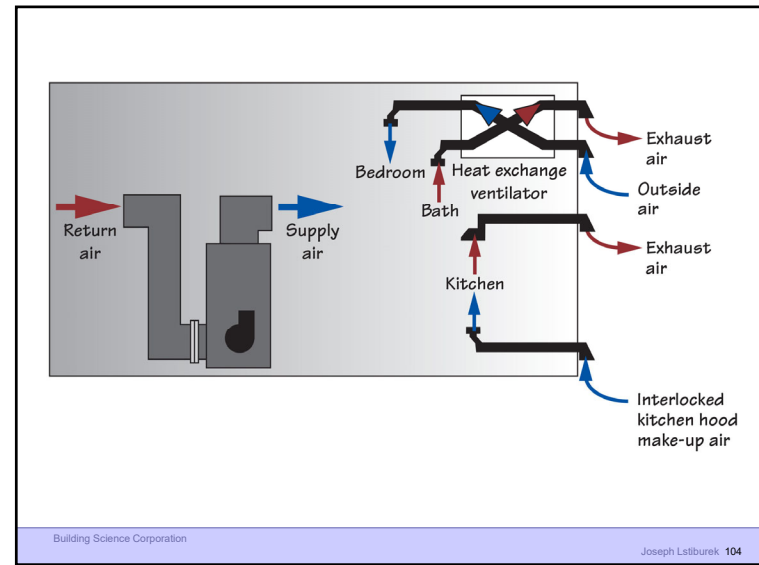

104

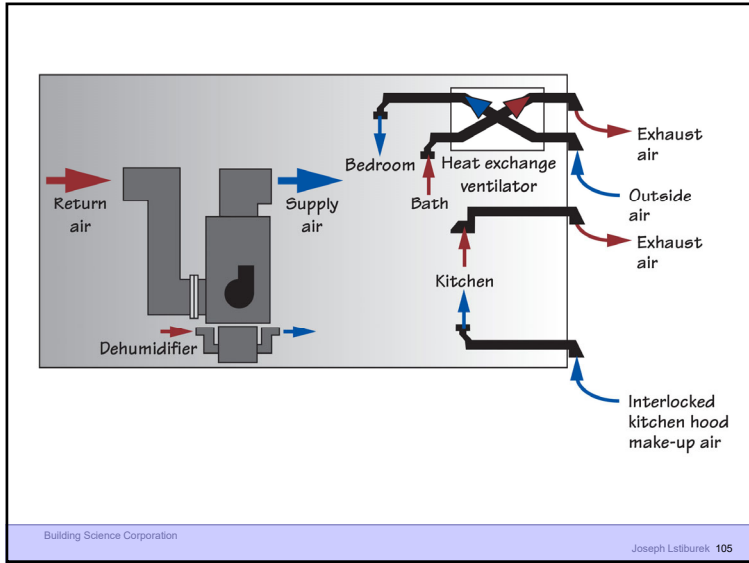

105

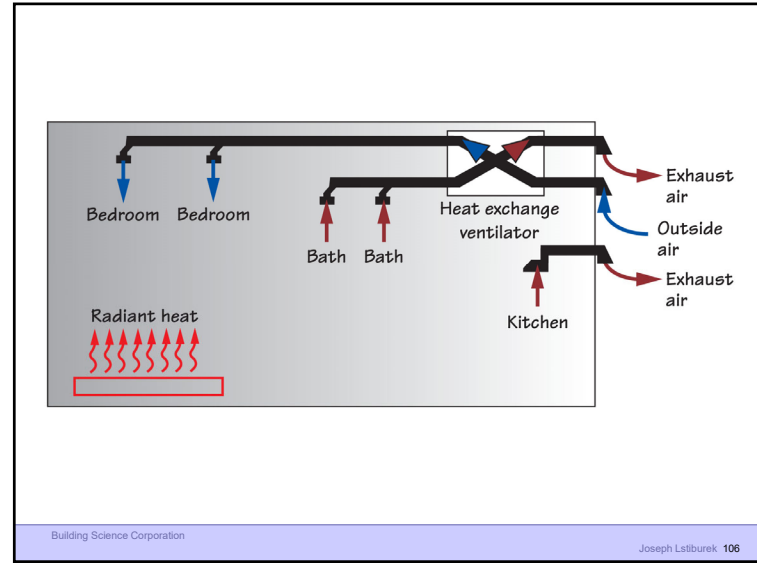

106

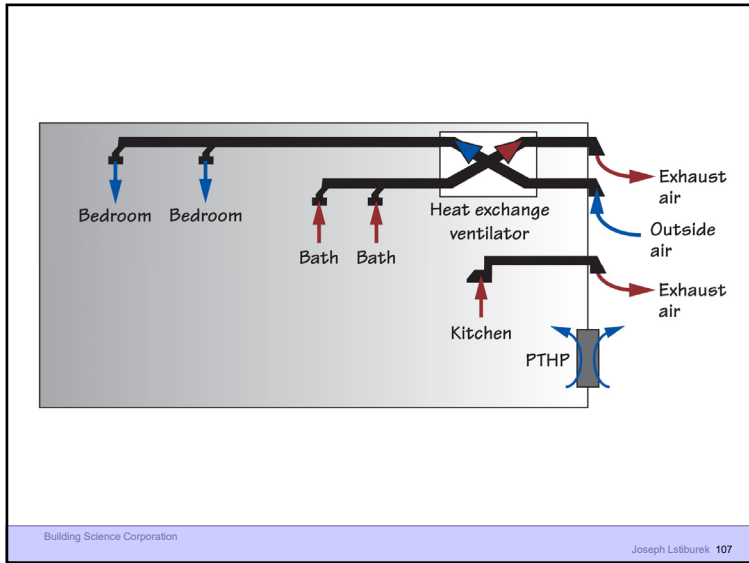

107

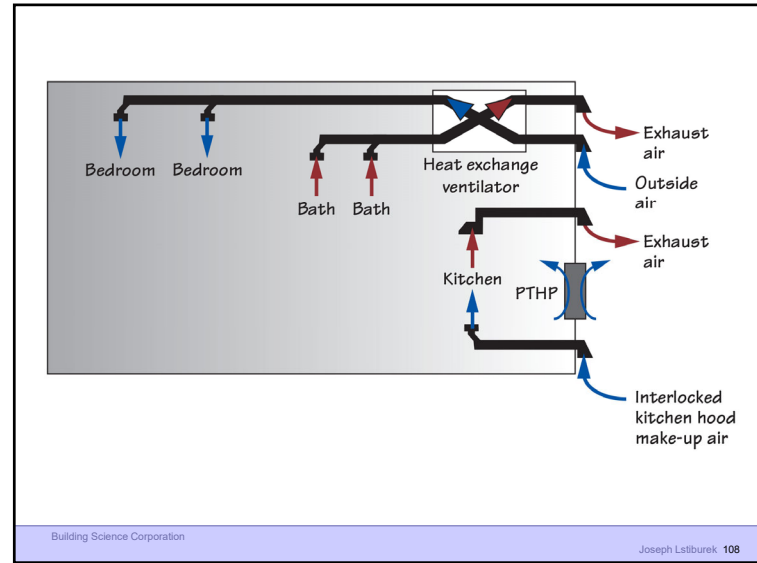

108

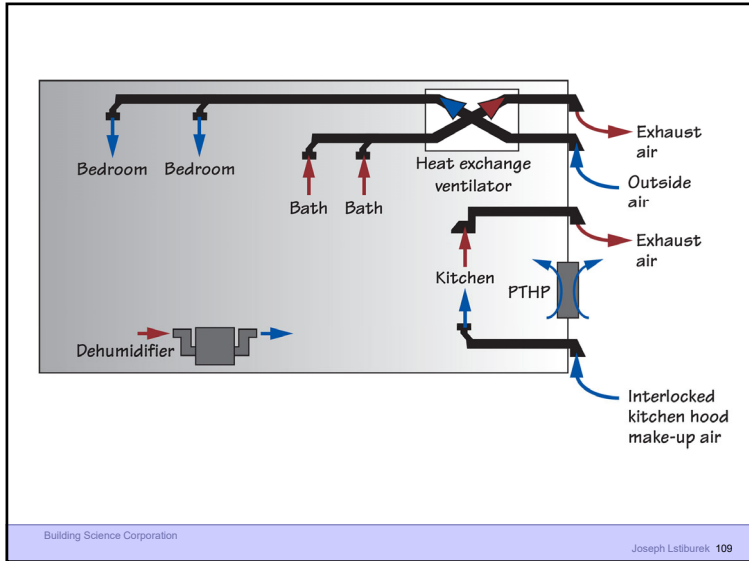

109



110

Lapse Rate

Building Science Corporation Joseph Lstiburek 111

111

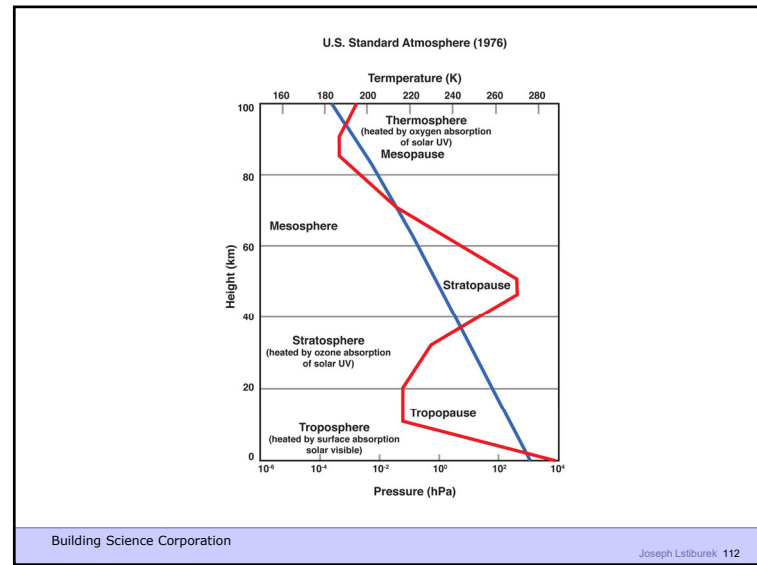

112

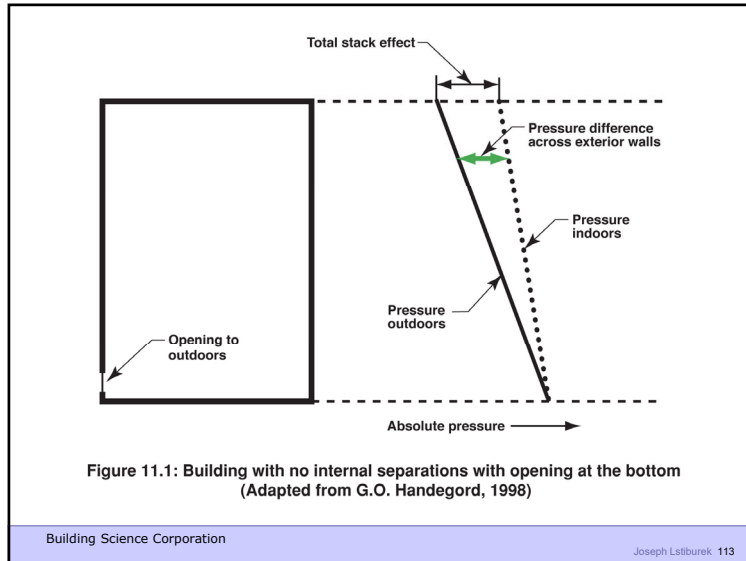

113

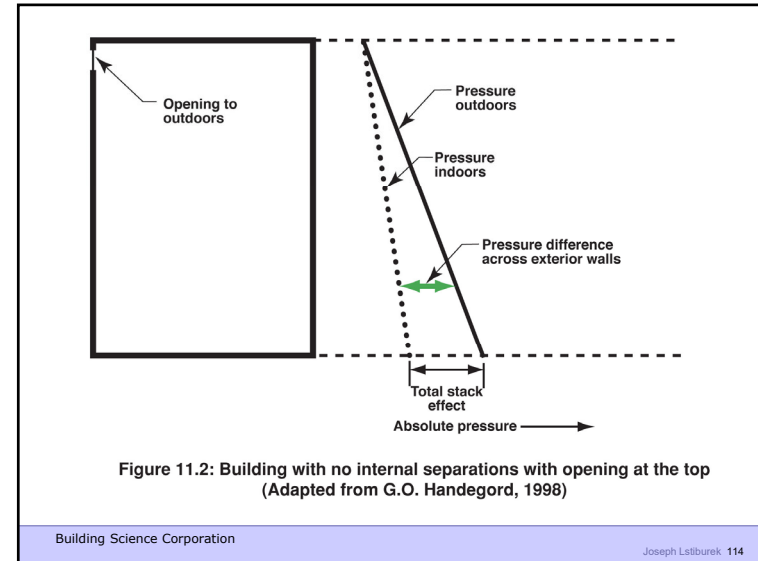

114

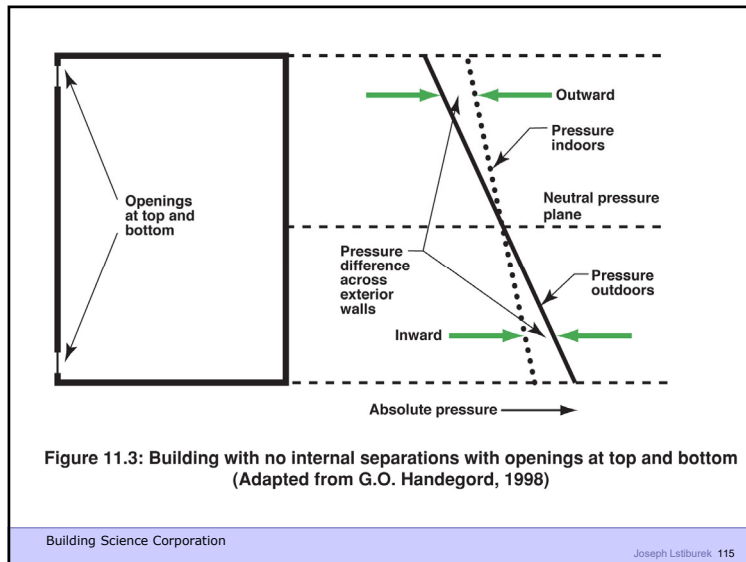

115

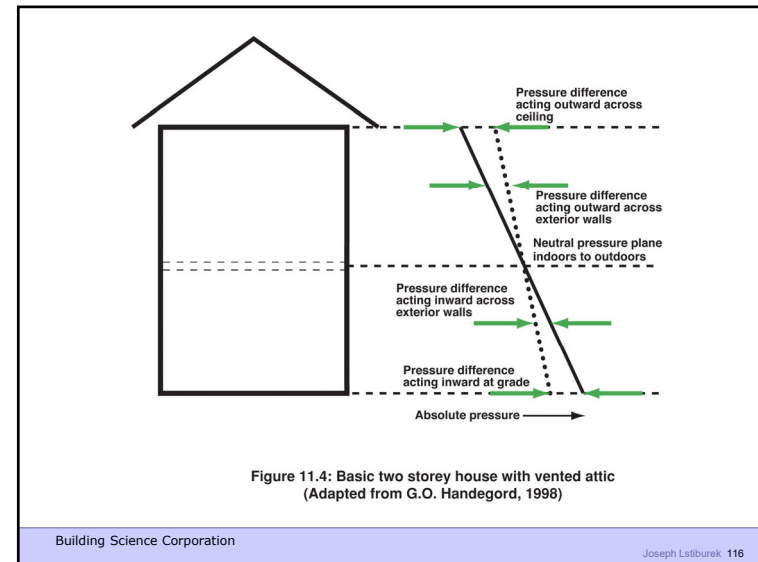

116



Building Science Corporation

Joseph Lstiburek 117

117

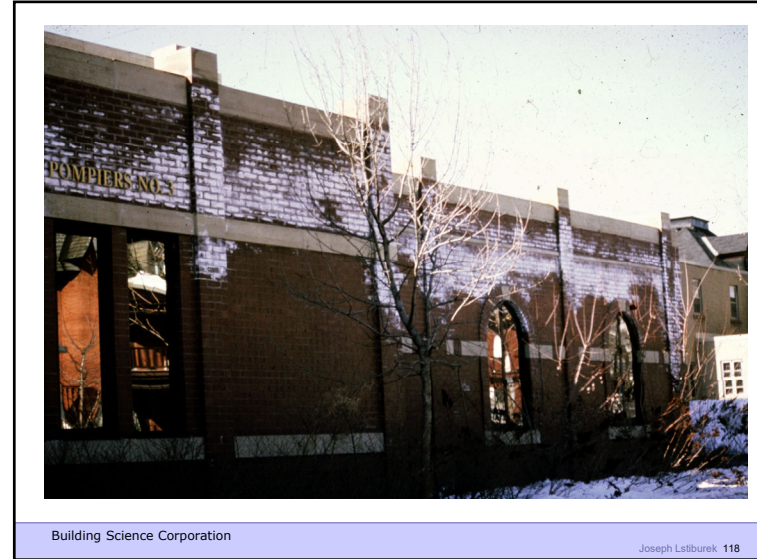

Building Science Corporation

Joseph Lstiburek 118

118

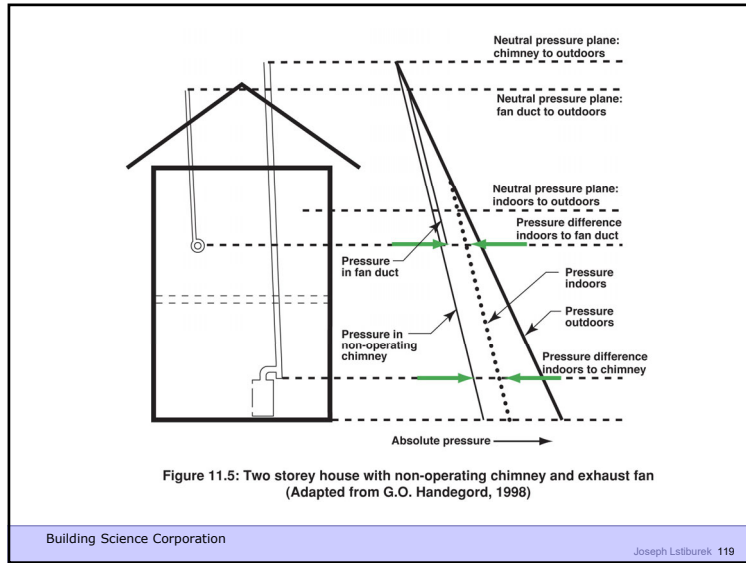

Figure 11.5: Two storey house with non-operating chimney and exhaust fan (Adapted from G.O. Handegord, 1998)

Building Science Corporation

Joseph Lstiburek 119

119

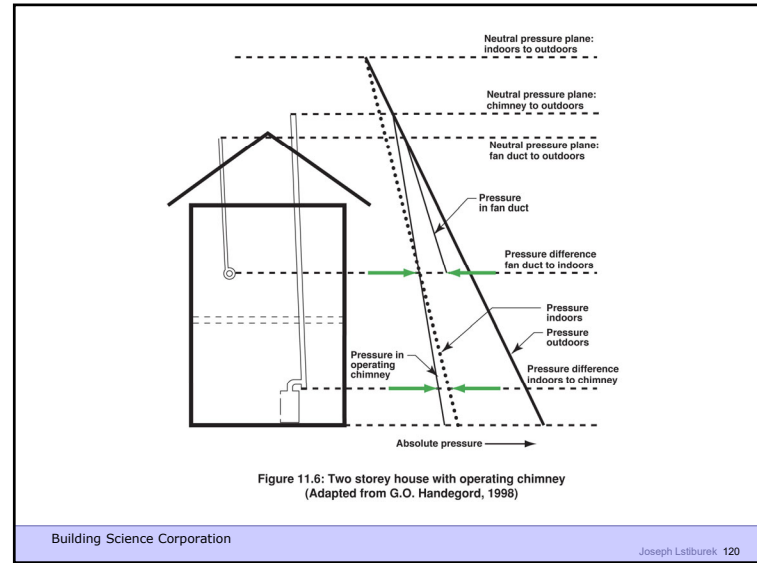
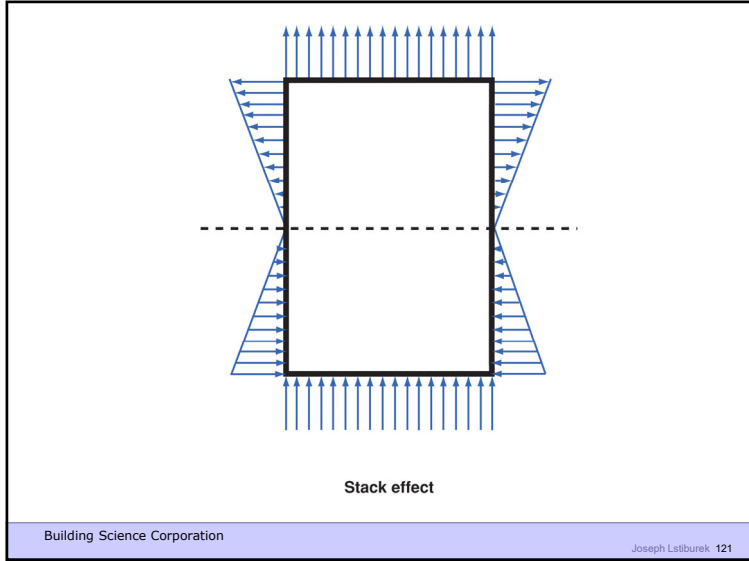

Figure 11.6: Two storey house with operating chimney (Adapted from G.O. Handegord, 1998)

Building Science Corporation

Joseph Lstiburek 120

120



121

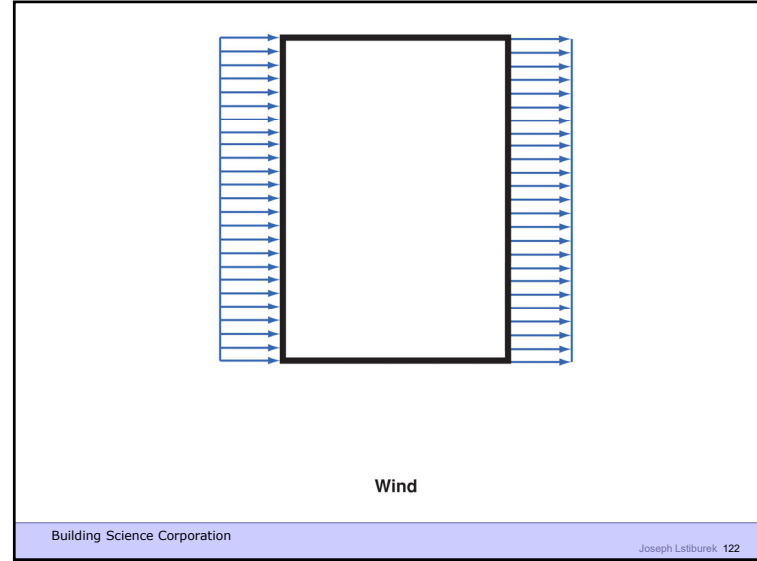

122

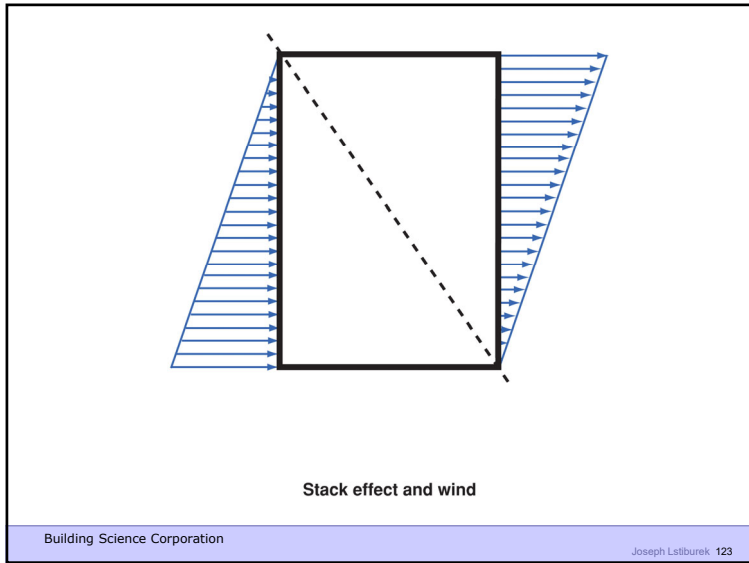

123

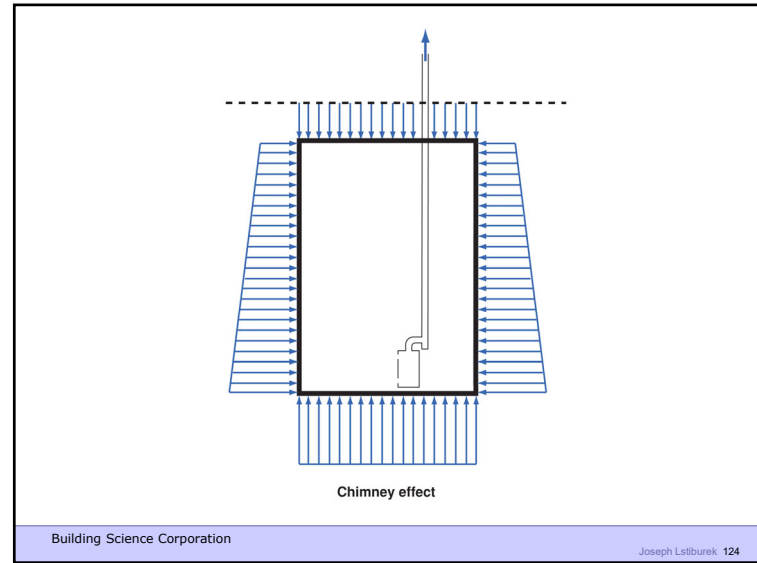

124

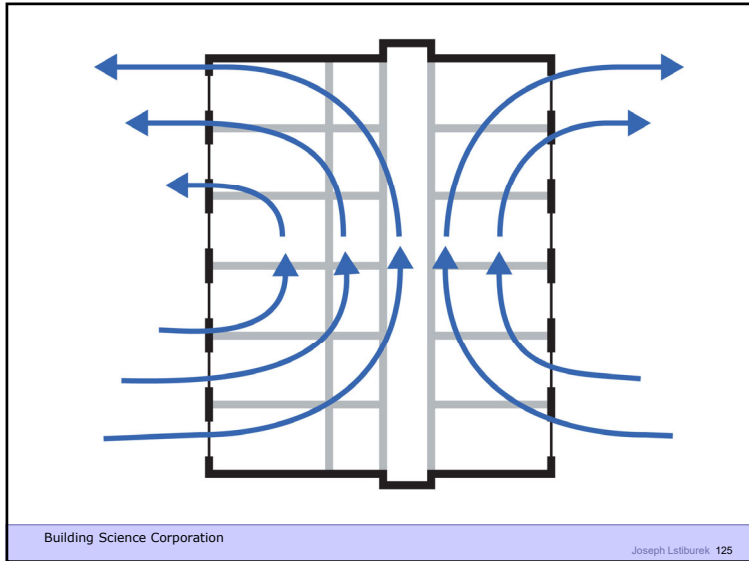

125

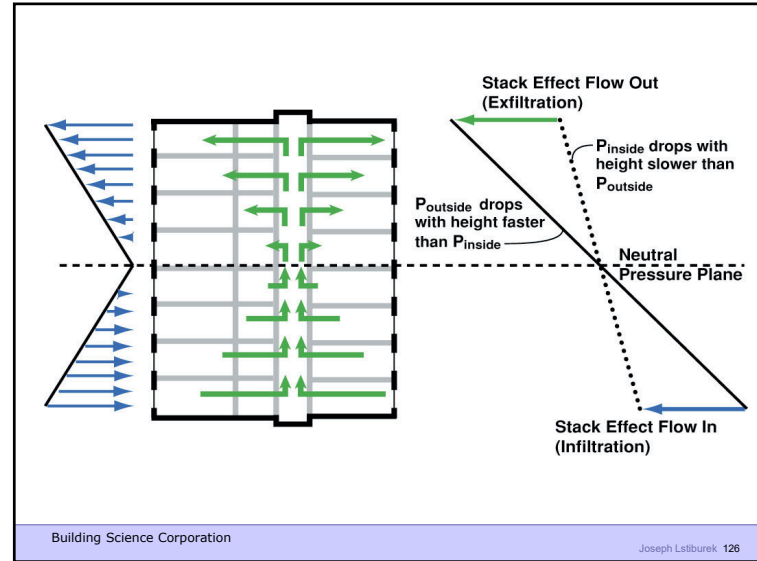

126

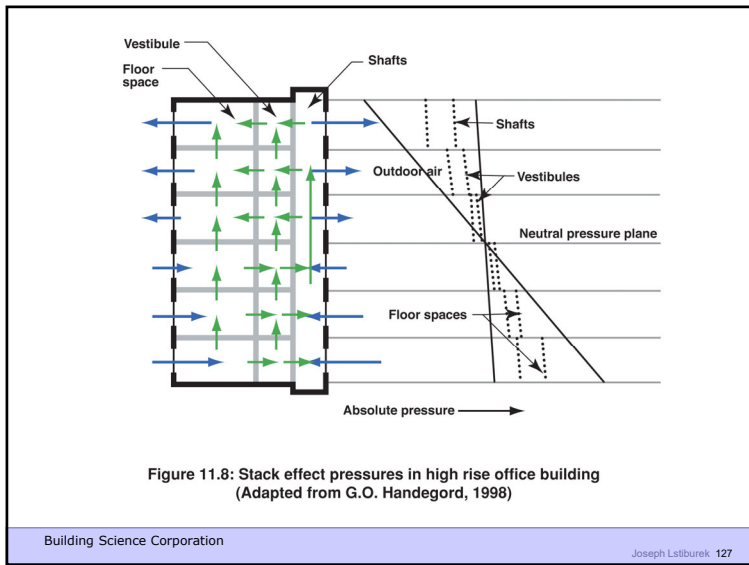

127

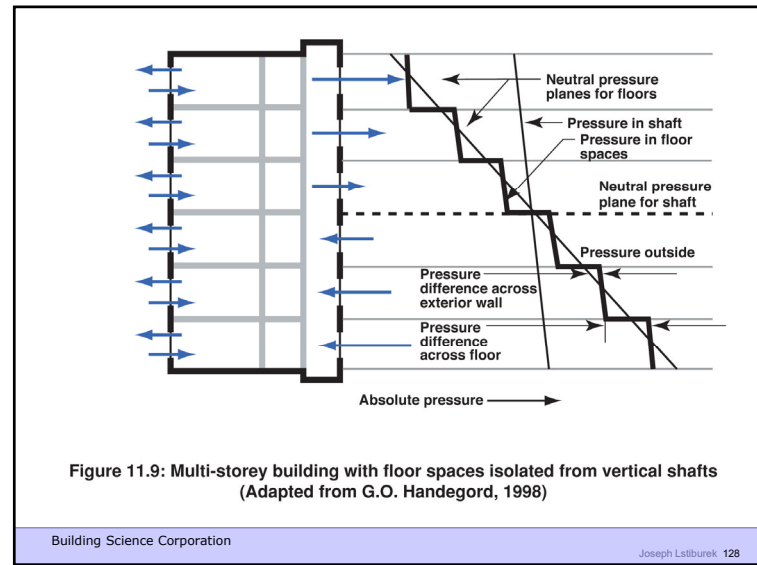

128

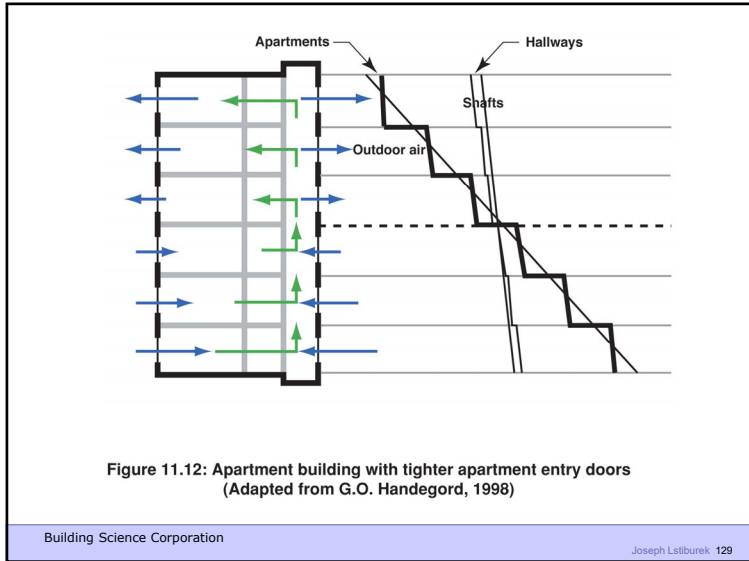

129

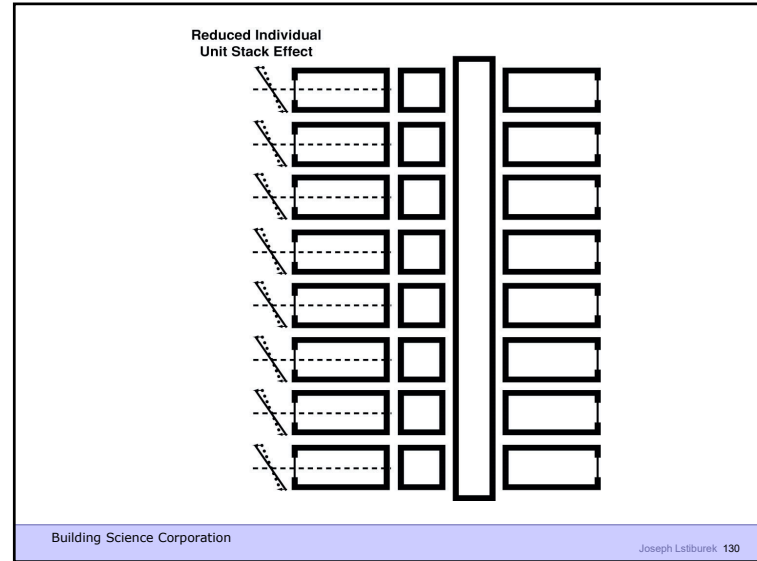

130

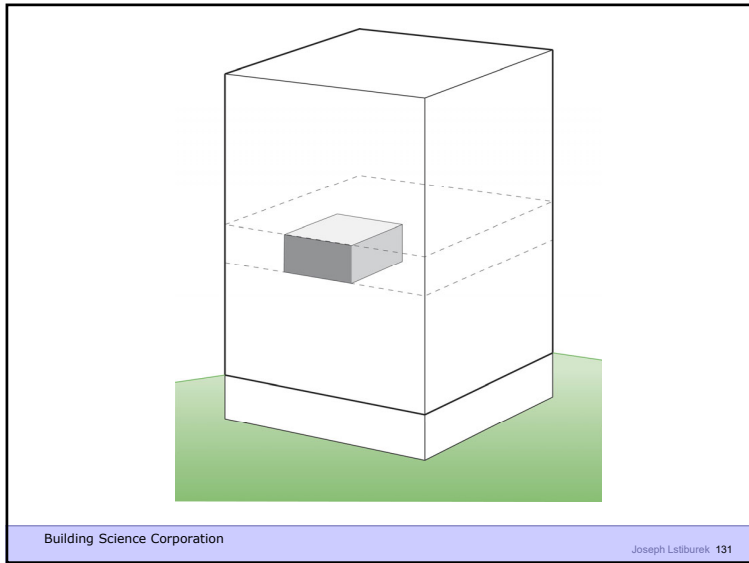

131

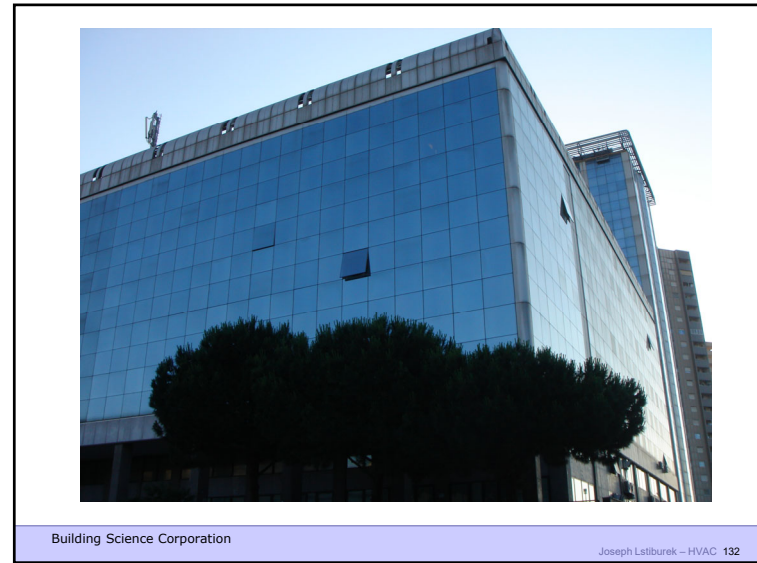

132

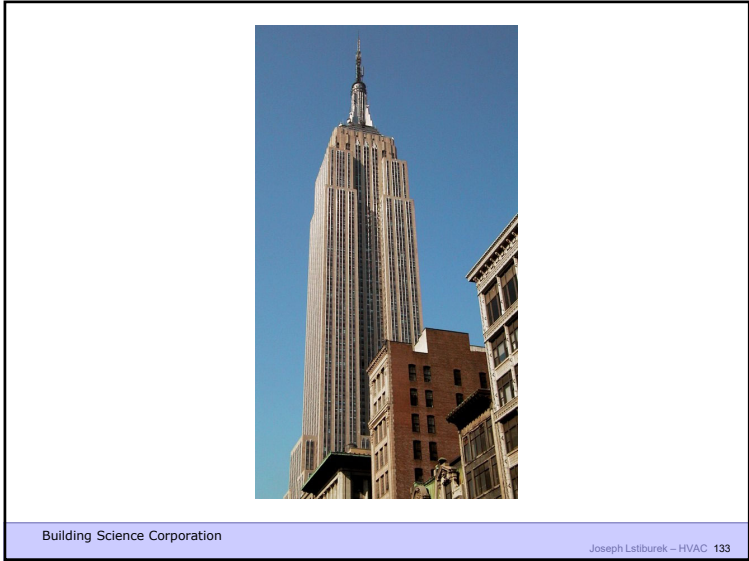

133

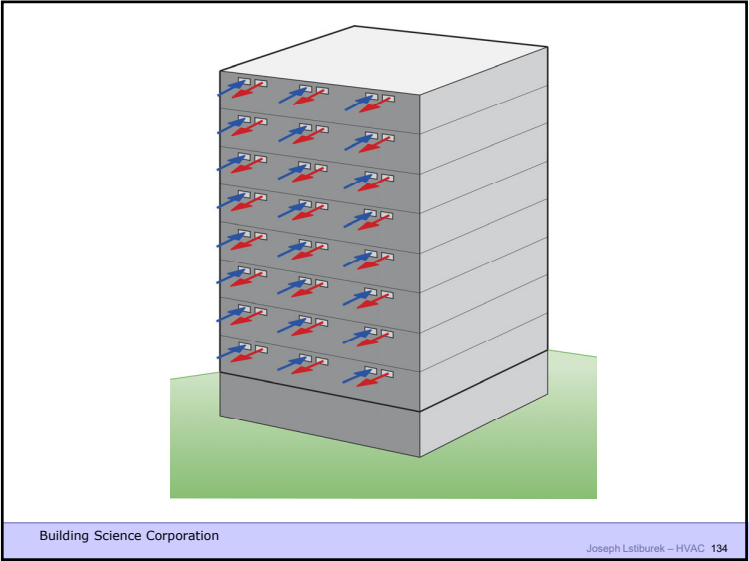

134

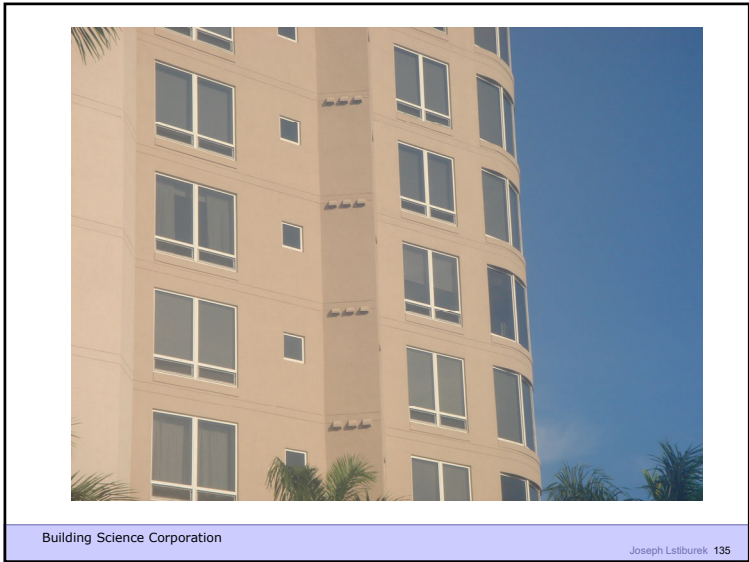

135

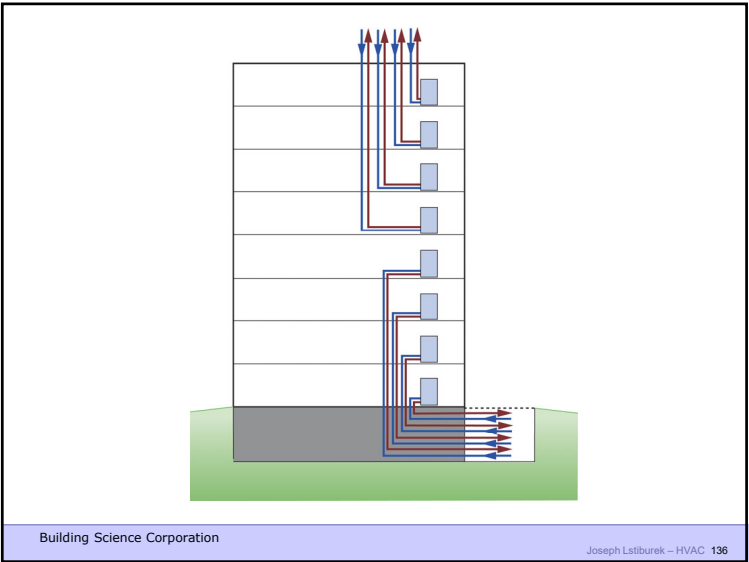

136

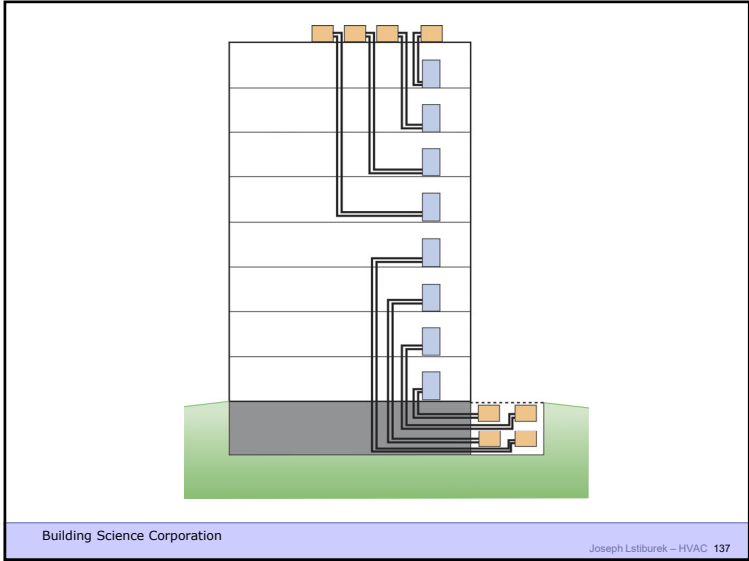

137

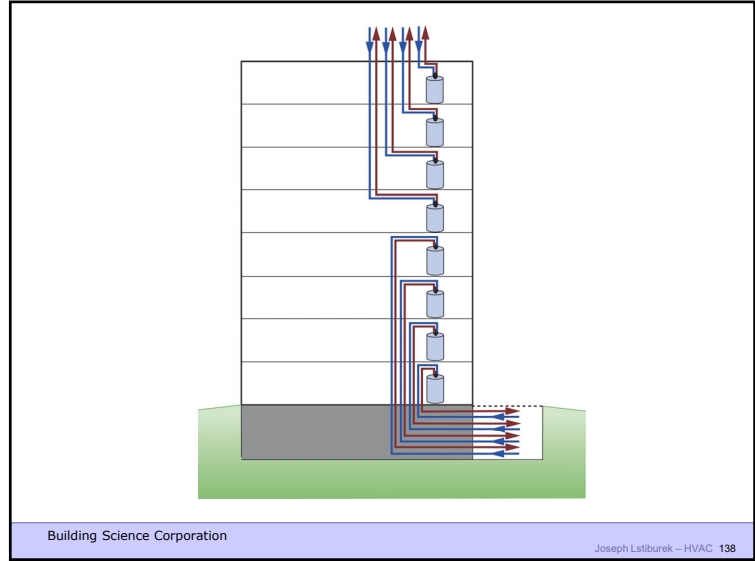

138



139

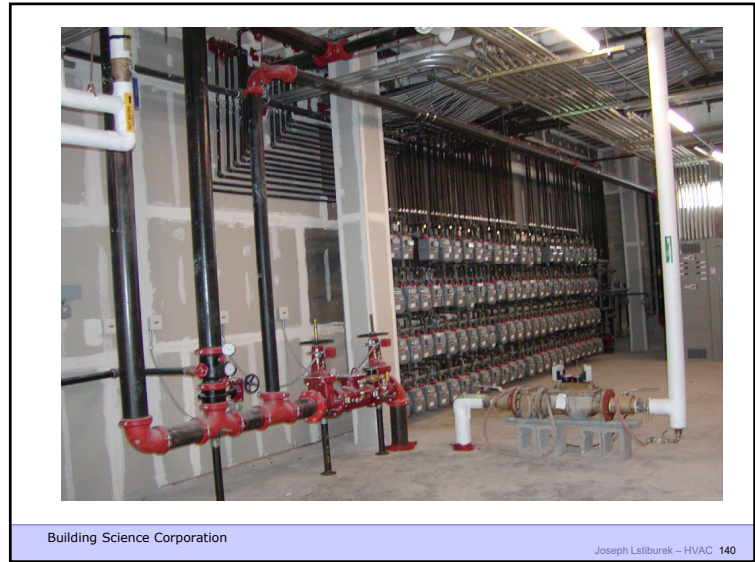

140



Building Science Corporation

Joseph Lstiburek – HVAC 141

141



Building Science Corporation

Joseph Lstiburek – HVAC 142

142



Building Science Corporation

Joseph Lstiburek – HVAC 143

143



Building Science Corporation

Joseph Lstiburek – HVAC 144

144



145



146



147

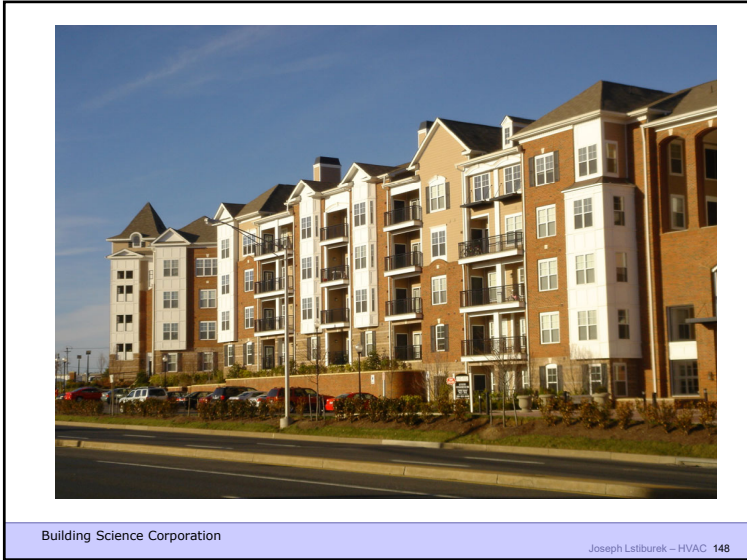

148



Building Science Corporation

Joseph Lstiburek – HVAC 149

149

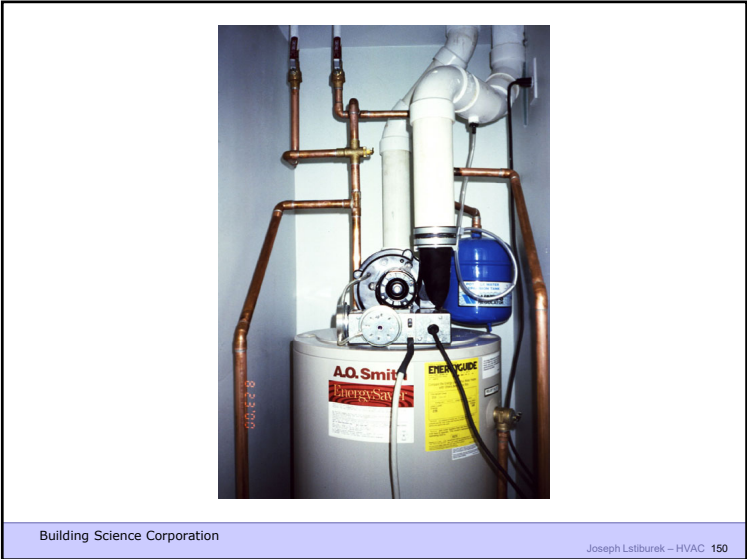

Building Science Corporation

Joseph Lstiburek – HVAC 150

150



Building Science Corporation

Joseph Lstiburek 151

151

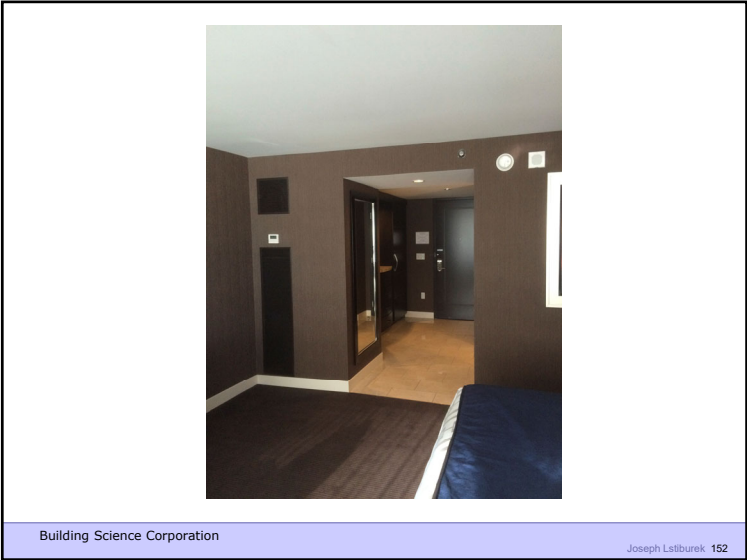

Building Science Corporation

Joseph Lstiburek 152

152

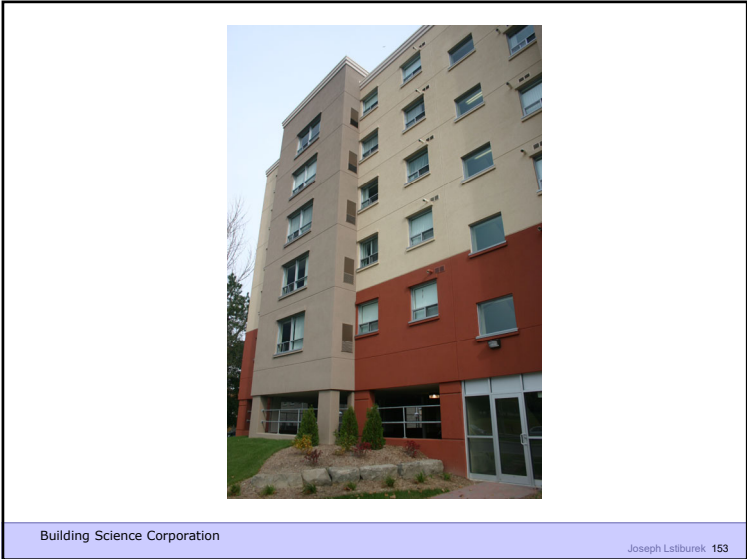

153

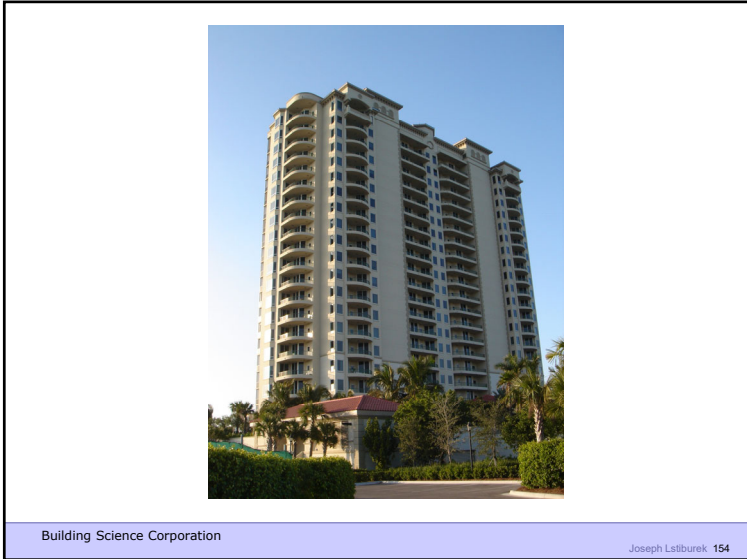

154



155



156



Building Science Corporation

Joseph Lstiburek 157

157



Building Science Corporation

Joseph Lstiburek 158

158



Building Science Corporation

Joseph Lstiburek 159

159



Building Science Corporation

Joseph Lstiburek - HVAC 160

160

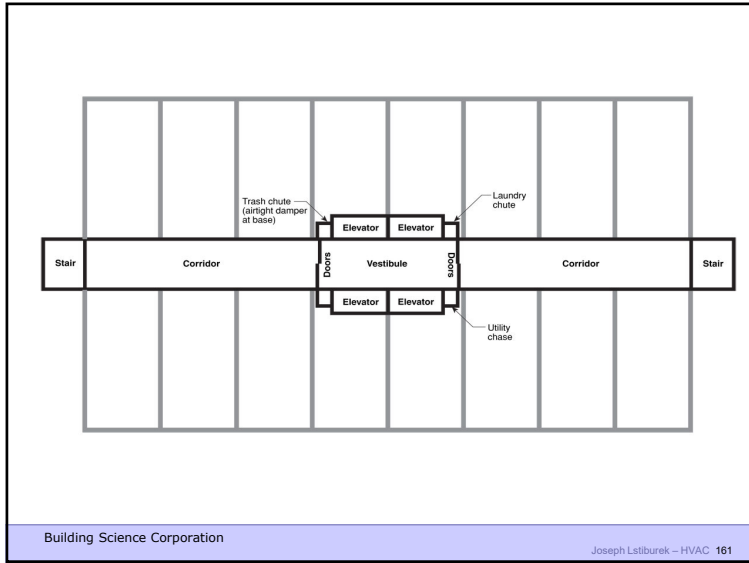

161



162

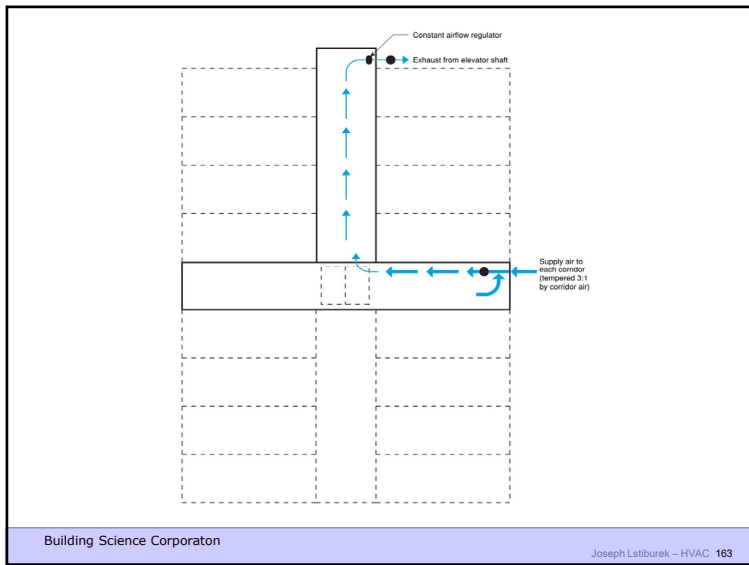

163

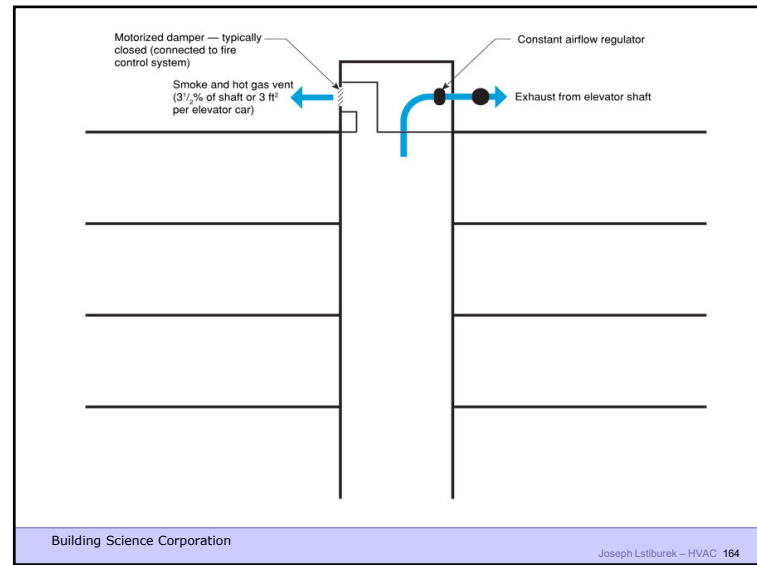

164

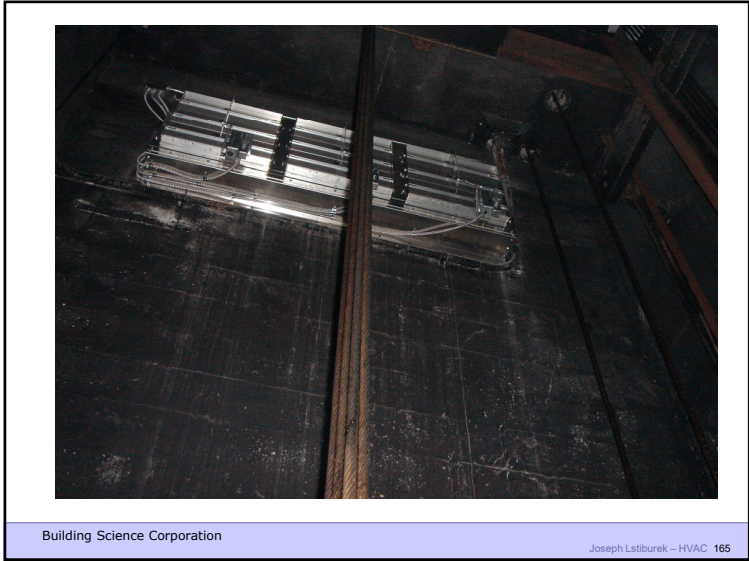

165

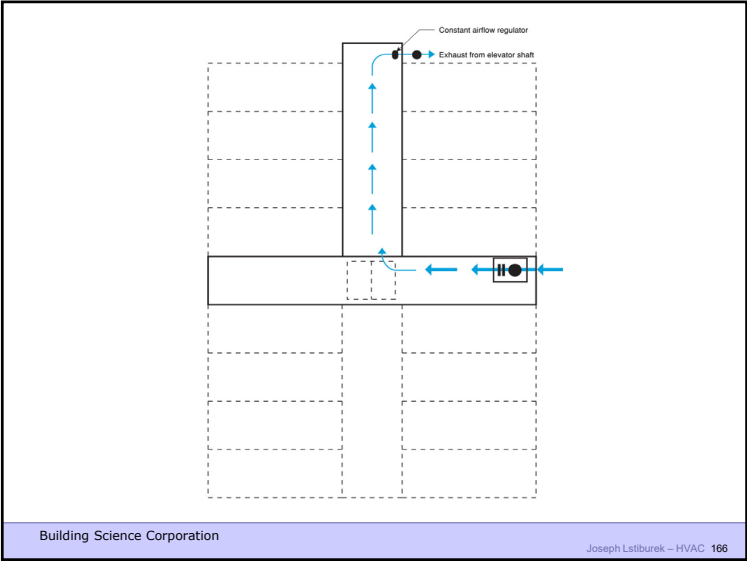

166

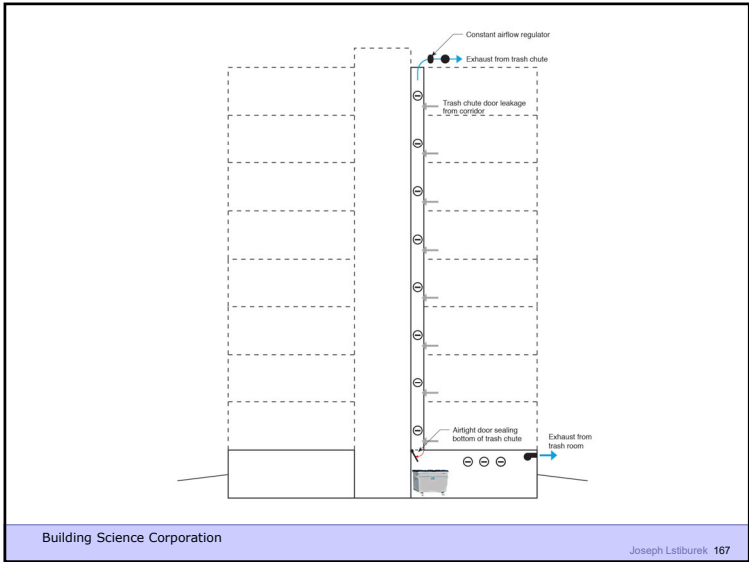

167



168

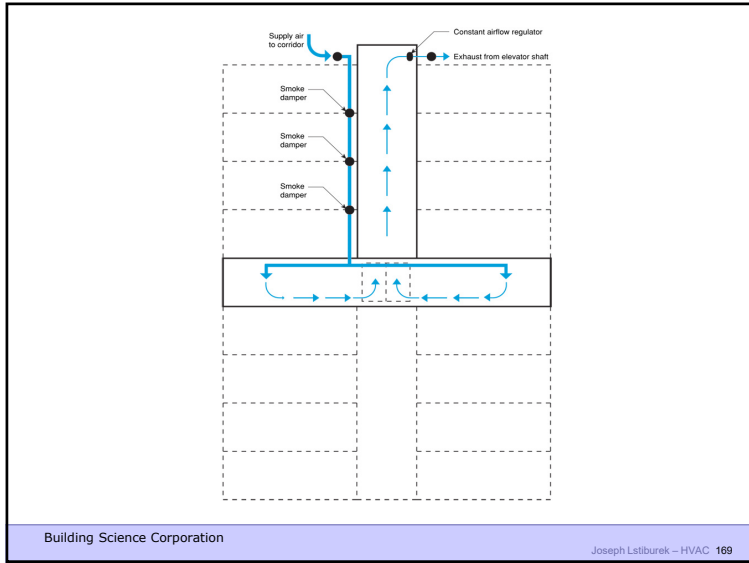

169

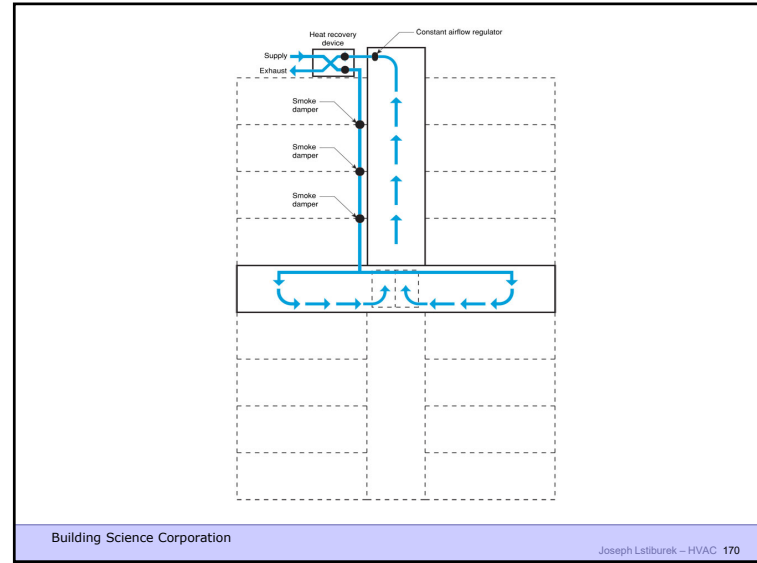

170

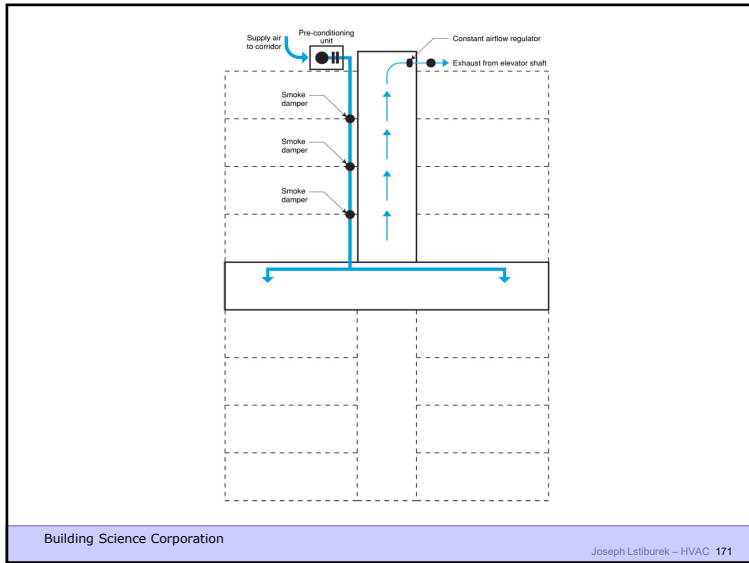

171

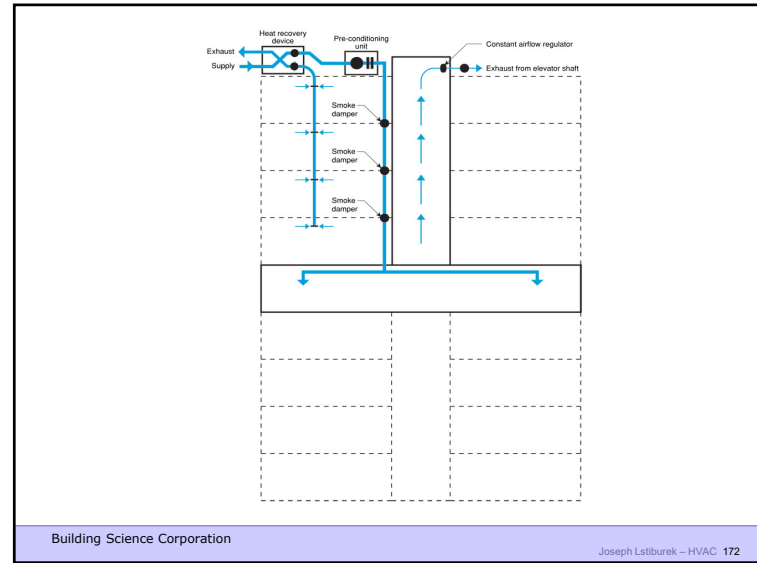

172

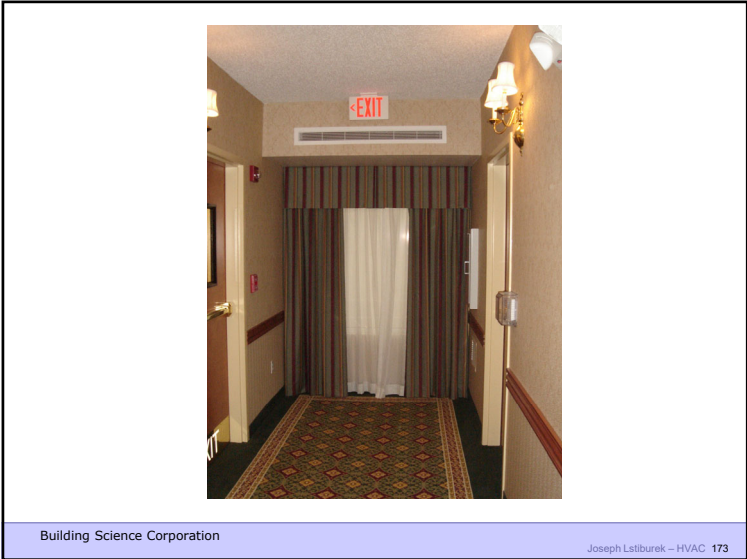

Building Science Corporation

Joseph Lstiburek - HVAC 173

173

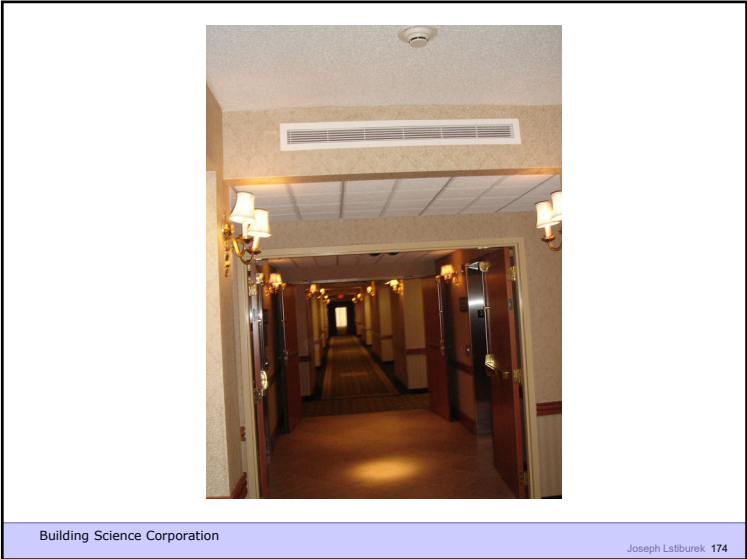

Building Science Corporation

Joseph Lstiburek 174

174



Building Science Corporation

Joseph Lstiburek 175

175

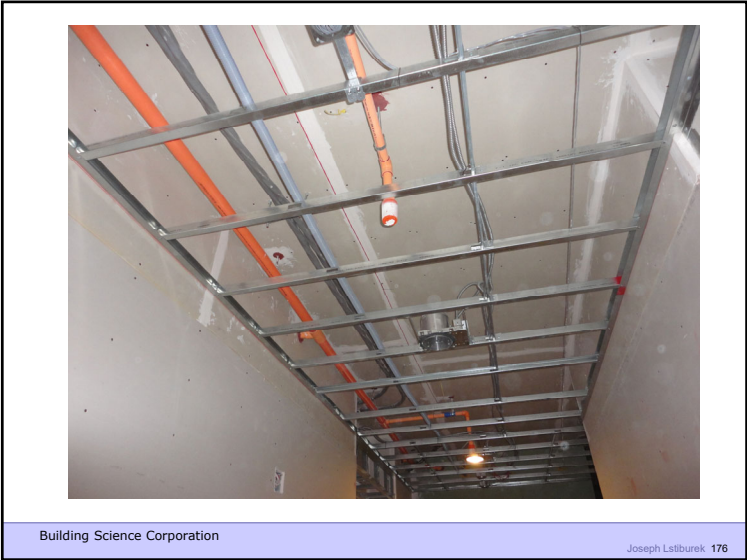

Building Science Corporation

Joseph Lstiburek 176

176



Building Science Corporation

Joseph Lstiburek 177

177

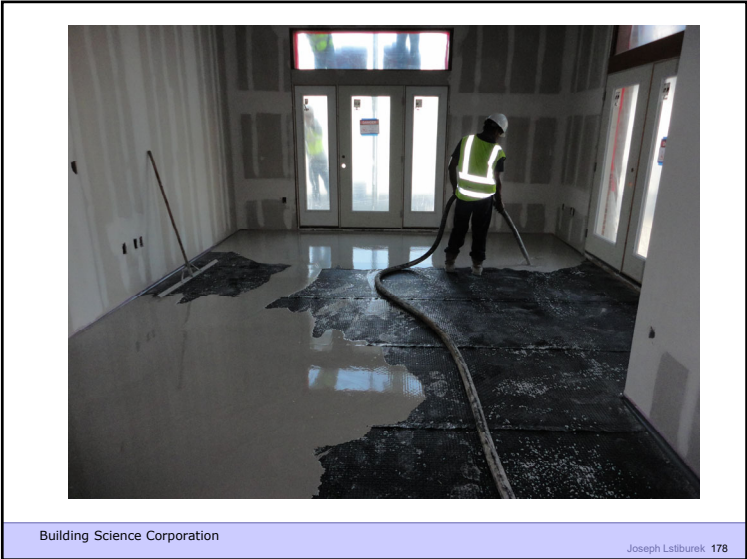

Building Science Corporation

Joseph Lstiburek 178

178



Building Science Corporation

Joseph Lstiburek 179

179



Building Science Corporation 2010

Joseph Lstiburek 180

180



181

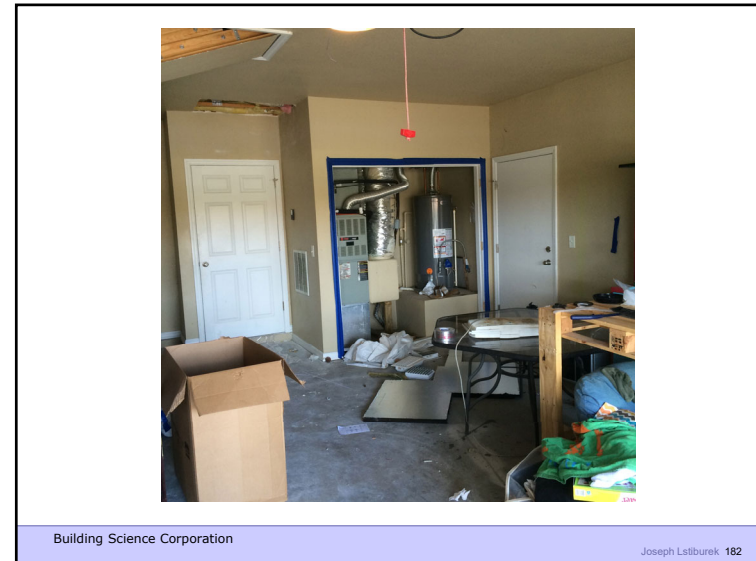

182

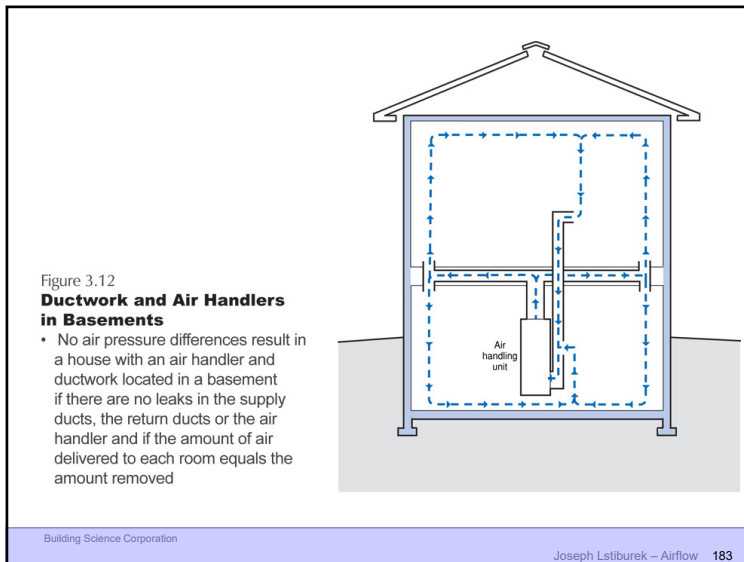

183

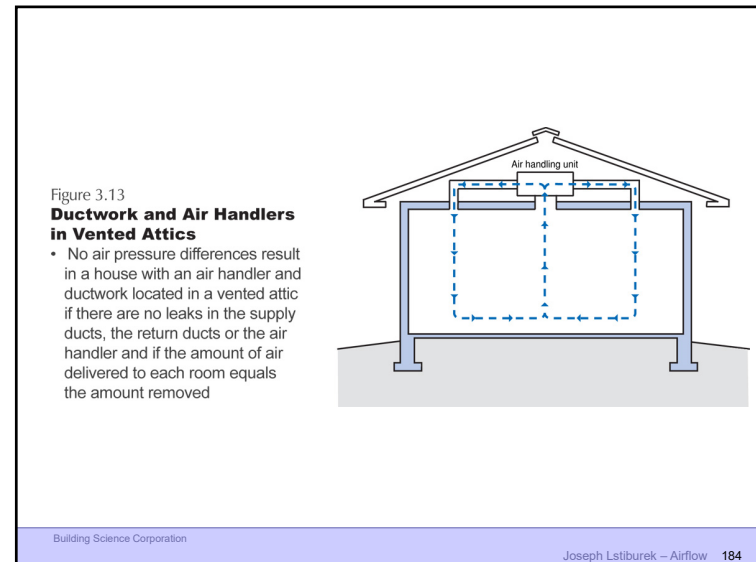

184

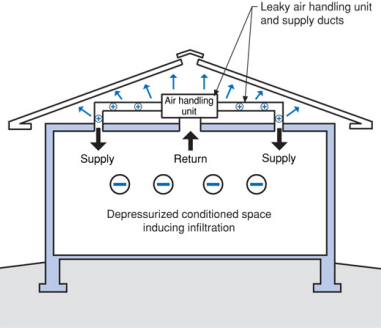

Figure 3.15
Leaky Ductwork and Air Handlers in Vented Attics

- Supply ductwork and air handler leakage is typically 20% or more of the flow through the system

Building Science Corporation
Joseph Lstiburek – Airflow 185

185



Building Science Corporation
Joseph Lstiburek – Airflow 186

186



Building Science Corporation
Joseph Lstiburek – Airflow 187

187



Building Science Corporation
Joseph Lstiburek – Airflow 188

188



Building Science Corporation

Joseph Lstiburek – Airflow 189

189



Building Science Corporation

Joseph Lstiburek – Airflow 190

190

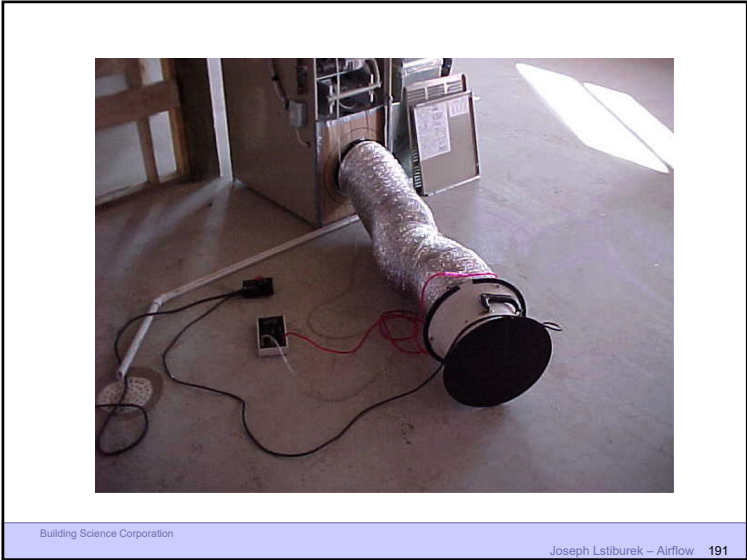

Building Science Corporation

Joseph Lstiburek – Airflow 191

191

Duct Leakage Should Be Less Than 5% of Rated Flow As Tested By Pressurization To 25 Pascals

Building Science Corporation

Joseph Lstiburek – Airflow 192

192

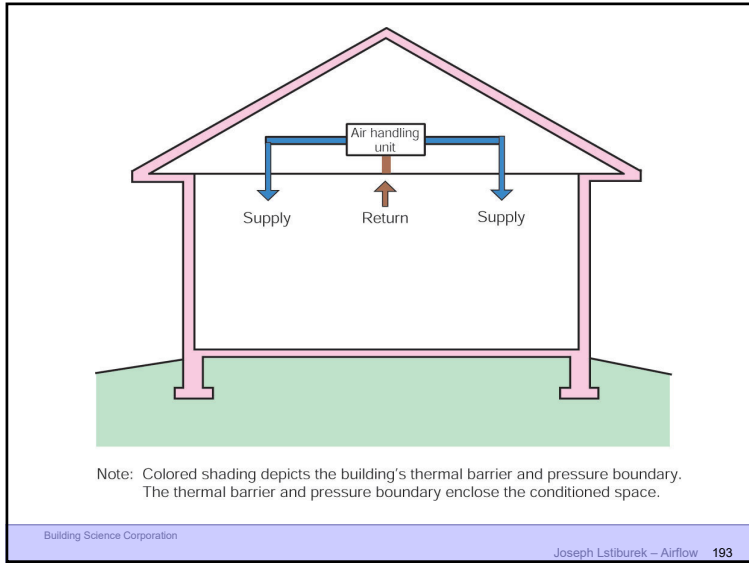

193

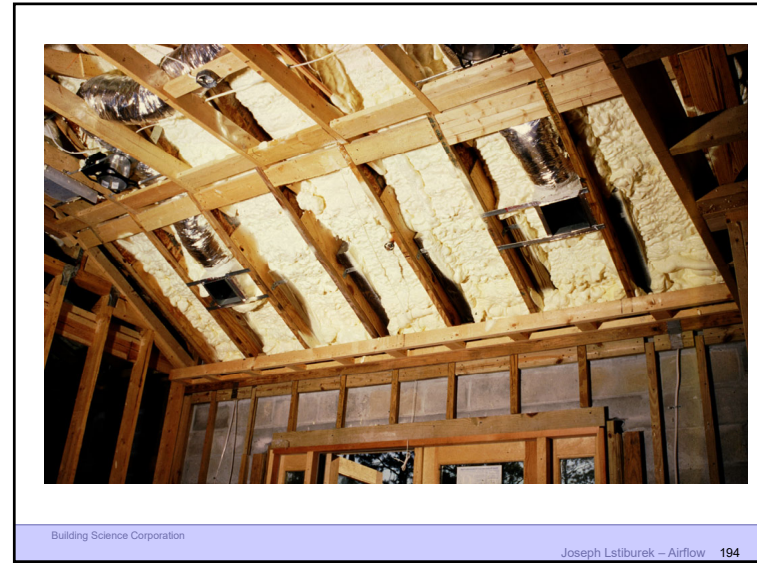

194

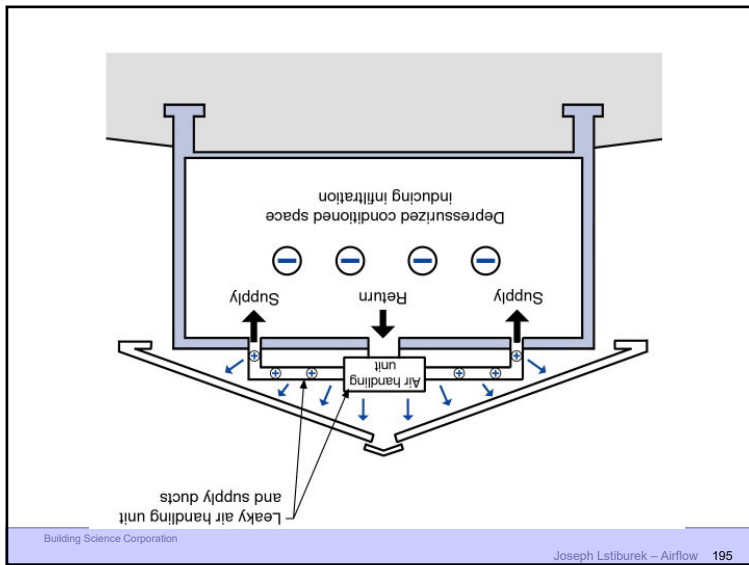

195

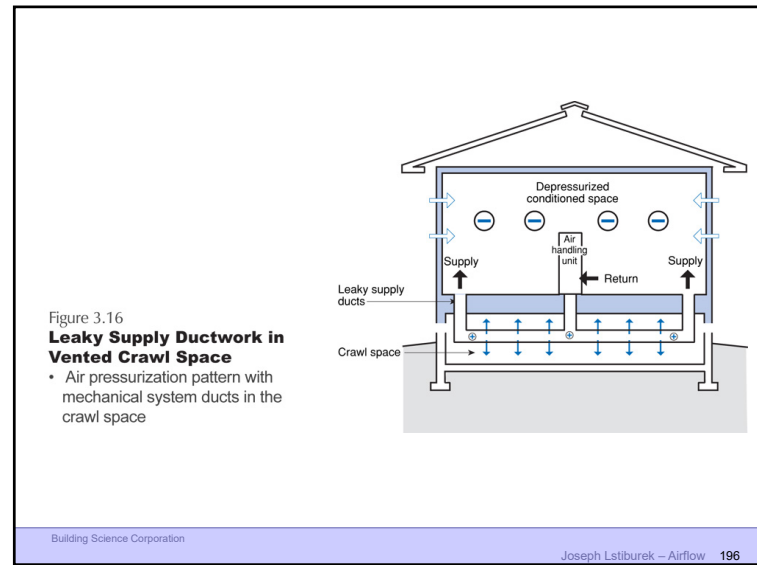

196



Building Science Corporation

Joseph Lstiburek – Airflow 197

197



Building Science Corporation

Joseph Lstiburek – Airflow 198

198

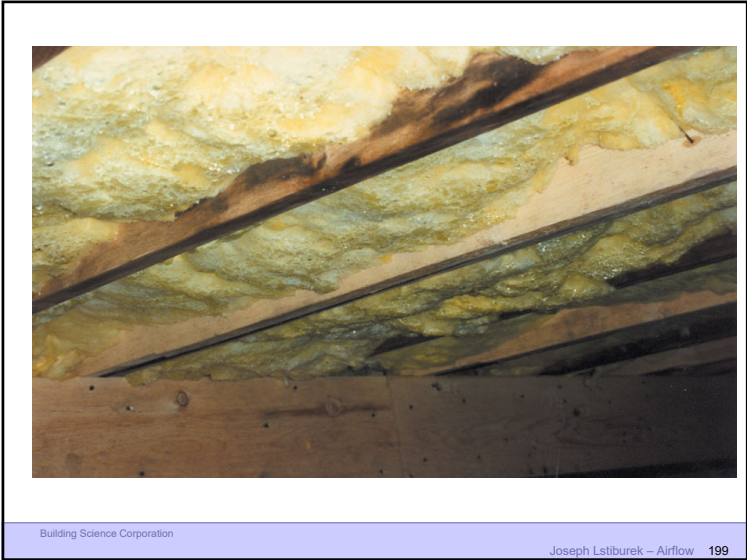

Building Science Corporation

Joseph Lstiburek – Airflow 199

199

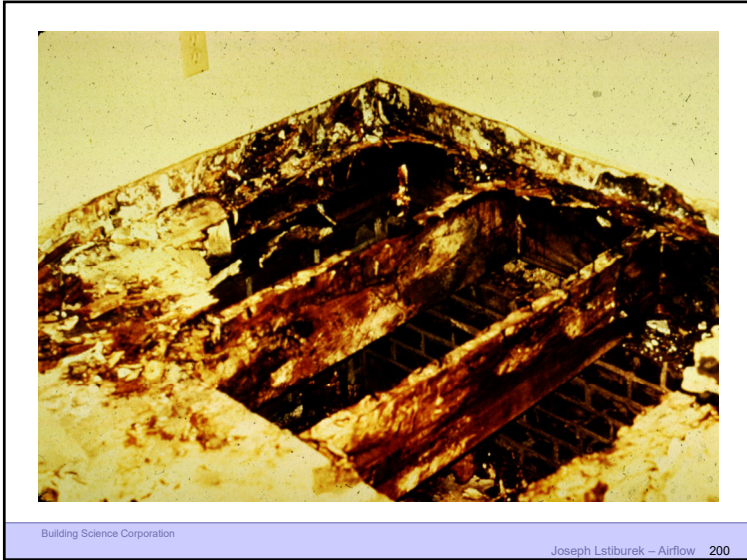

Building Science Corporation

Joseph Lstiburek – Airflow 200

200



Building Science Corporation

Joseph Lstiburek – Airflow 201

201



Building Science Corporation

Joseph Lstiburek – Airflow 202

202

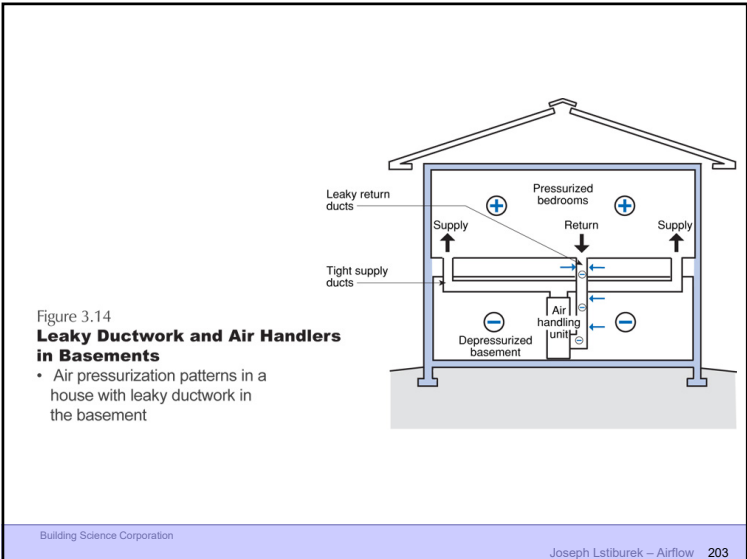

Building Science Corporation

Joseph Lstiburek – Airflow 203

203

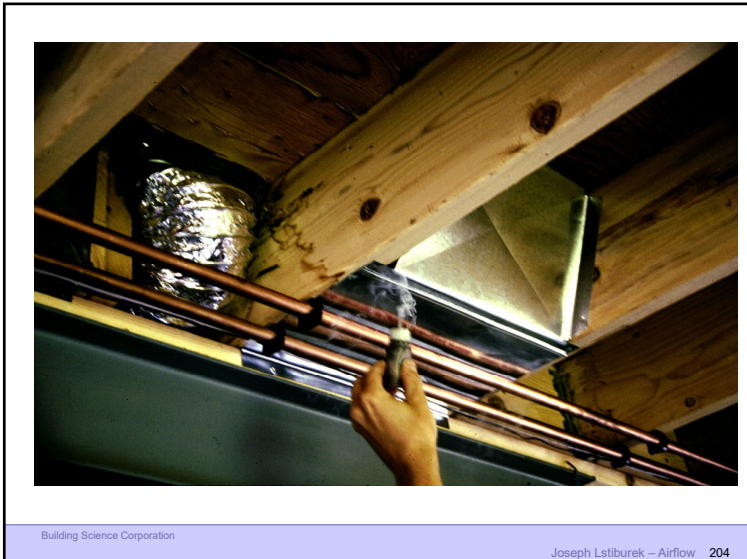

Building Science Corporation

Joseph Lstiburek – Airflow 204

204



Building Science Corporation

Joseph Lstiburek – Airflow 205

205



Building Science Corporation

Joseph Lstiburek – Airflow 206

206



Building Science Corporation

Joseph Lstiburek – Airflow 207

207



Building Science Corporation

Joseph Lstiburek – Airflow 208

208



209

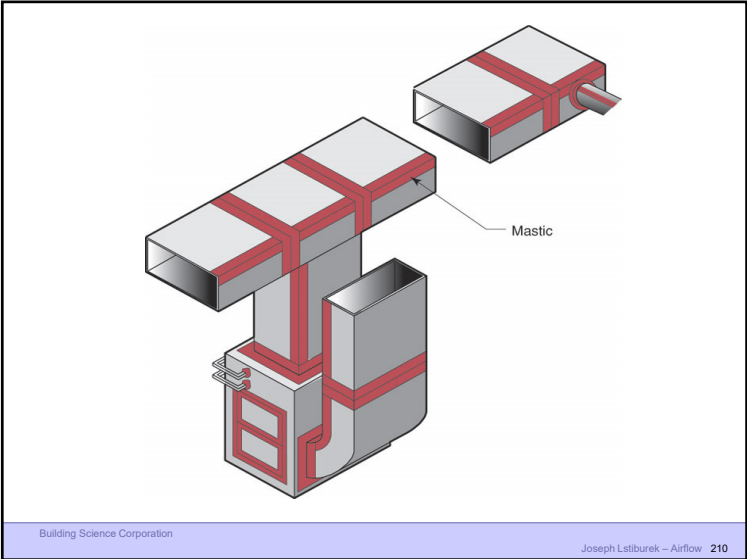

210



211



212

Figure 3.18
Insufficient Return Air Paths

- Pressurization of bedrooms often occurs if insufficient return pathways are provided; undercutting bedroom doors is usually insufficient; transfer grilles, jump ducts or fully ducted returns may be necessary to prevent pressurization of bedrooms
- Master bedroom suites are often the most pressurized as they typically receive the most supply air
- When bedrooms pressurized, common areas depressurize; this can have serious consequences when fireplaces are located in common areas and subsequently backdraft

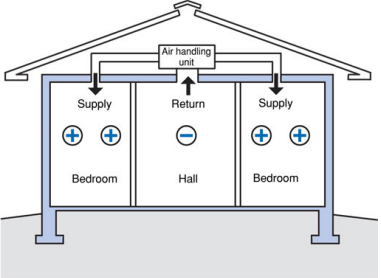

Building Science Corporation
 Joseph Lstiburek – Airflow 213

213

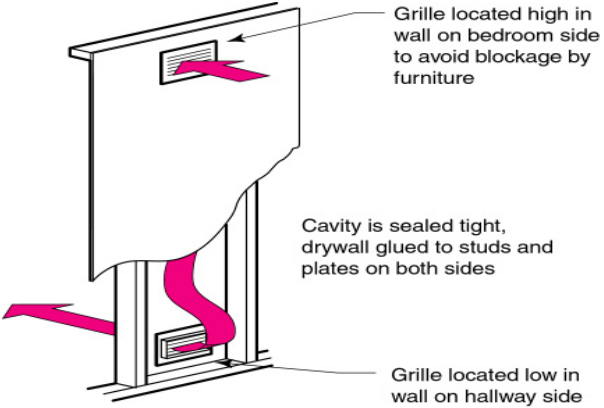

Grille located high in wall on bedroom side to avoid blockage by furniture

Cavity is sealed tight, drywall glued to studs and plates on both sides

Grille located low in wall on hallway side

Building Science Corporation
 Joseph Lstiburek – Airflow 214

214



Building Science Corporation
 Joseph Lstiburek – Airflow 215

215

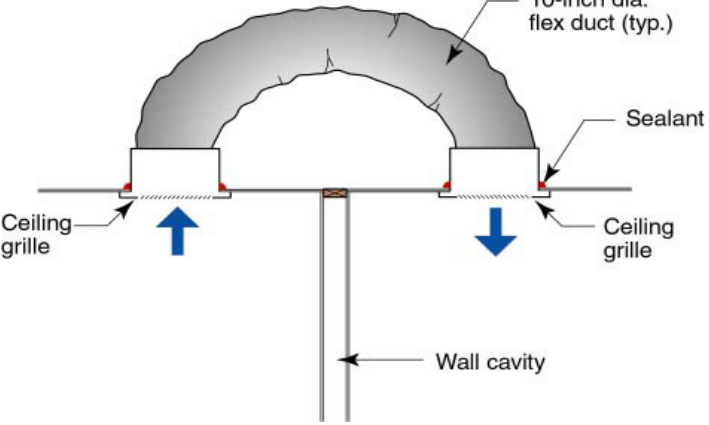

10-inch dia. flex duct (typ.)

Sealant

Ceiling grille

Wall cavity

Ceiling grille

Building Science Corporation
 Joseph Lstiburek – Airflow 216

216

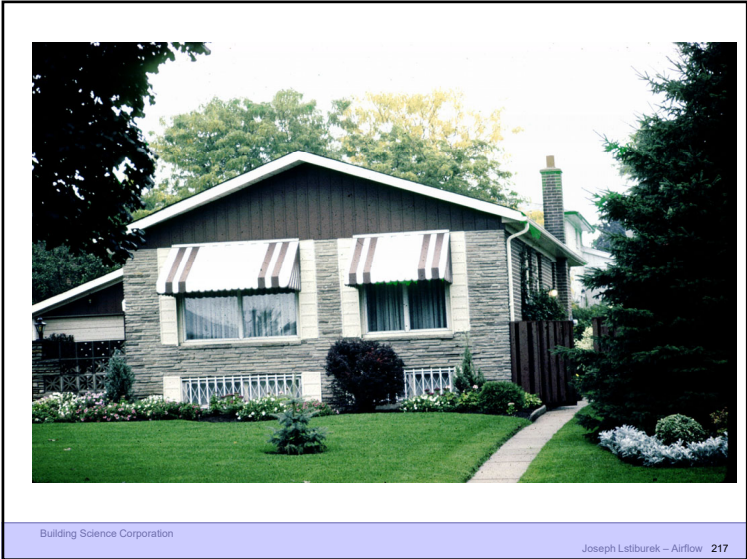

217

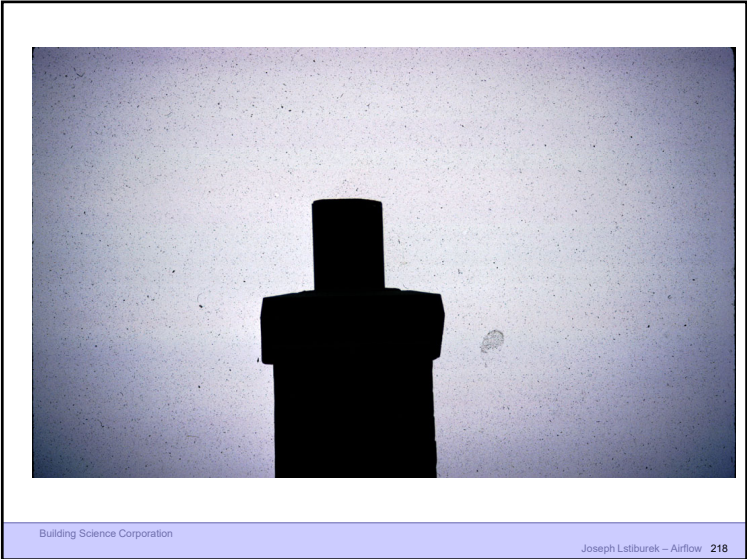

218



219



220

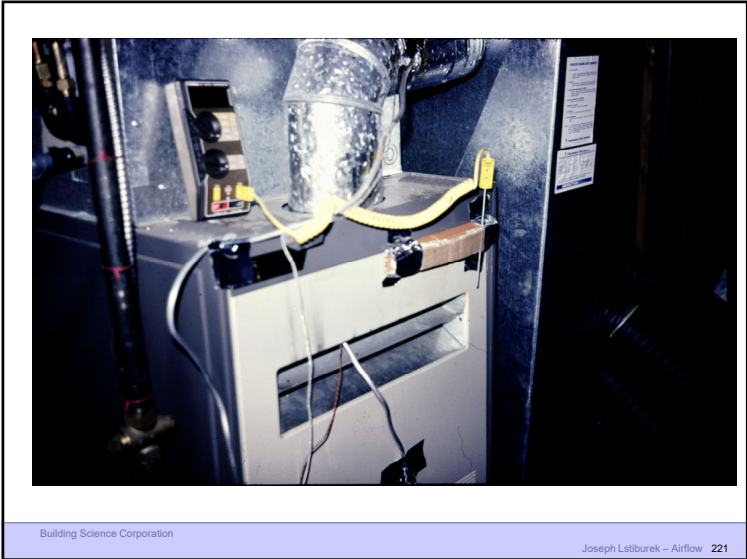

221

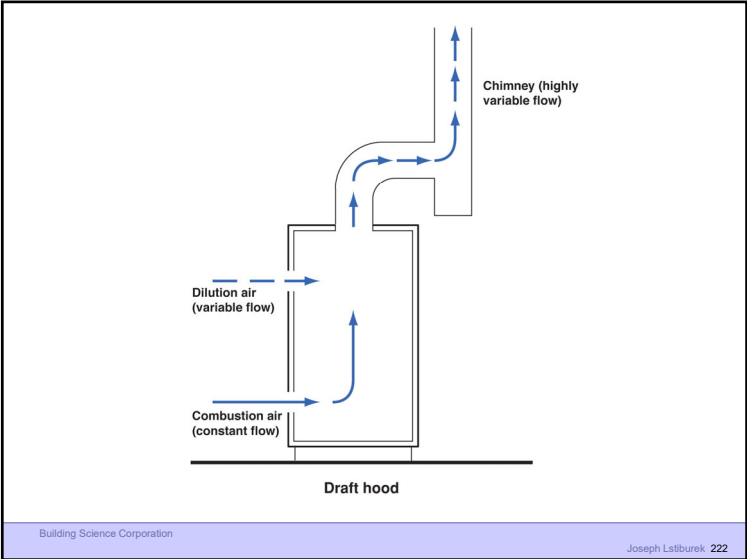

222

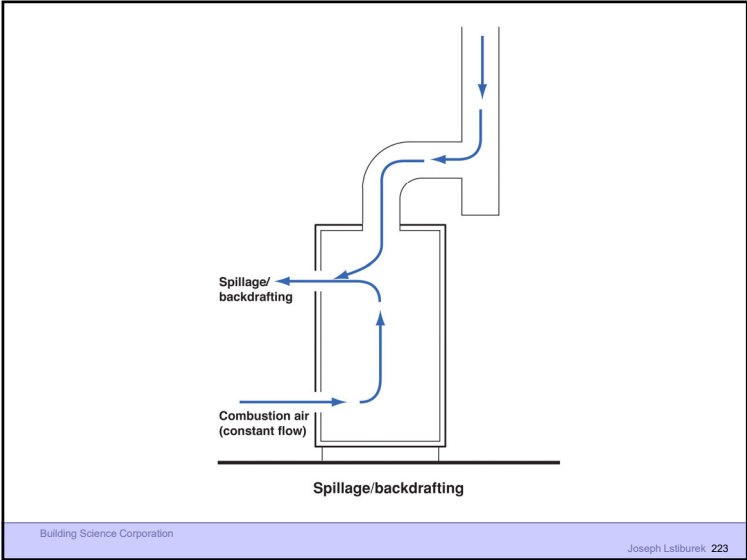

223



224



225

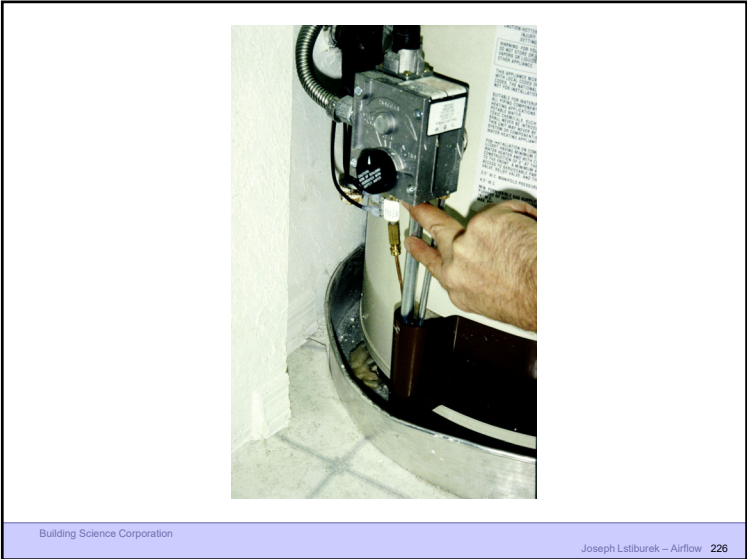

226

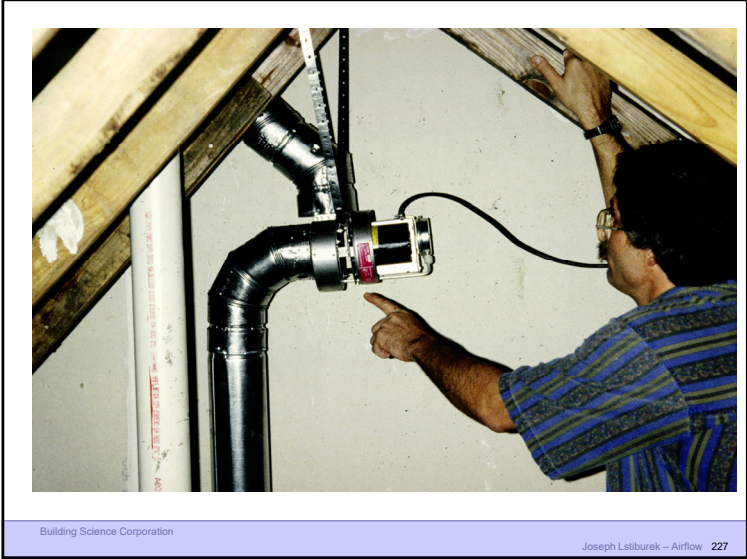

227