

Joseph Lstiburek, Ph.D., P.Eng, ASHRAE Fellow

Building Science

Adventures In Building Science

www.buildingscience.com

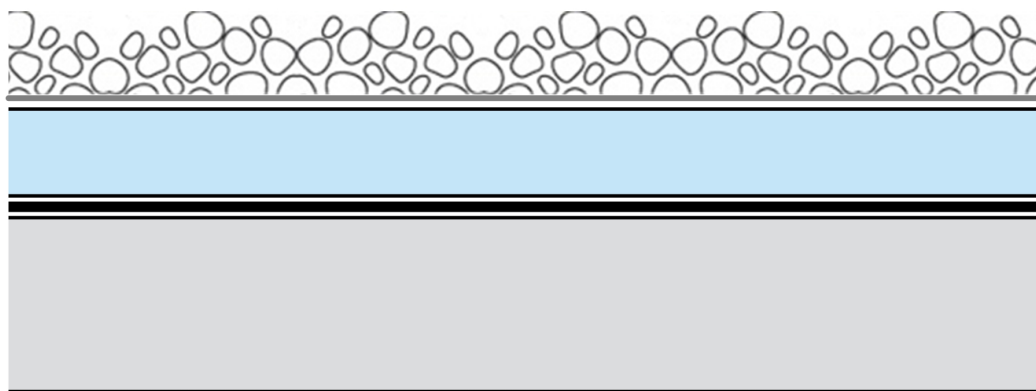

- ← Ballast
- ← Filter fabric
- ← Control layers
- ← Roof structure

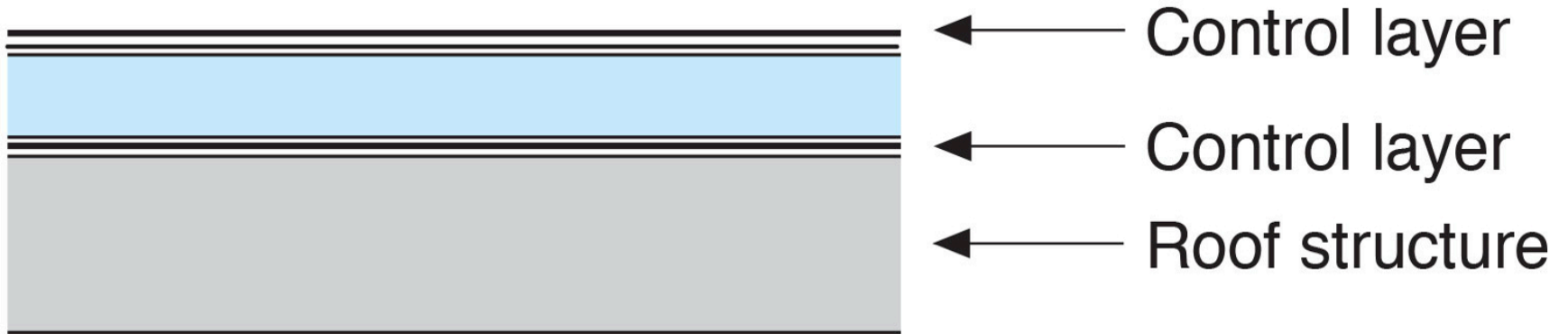

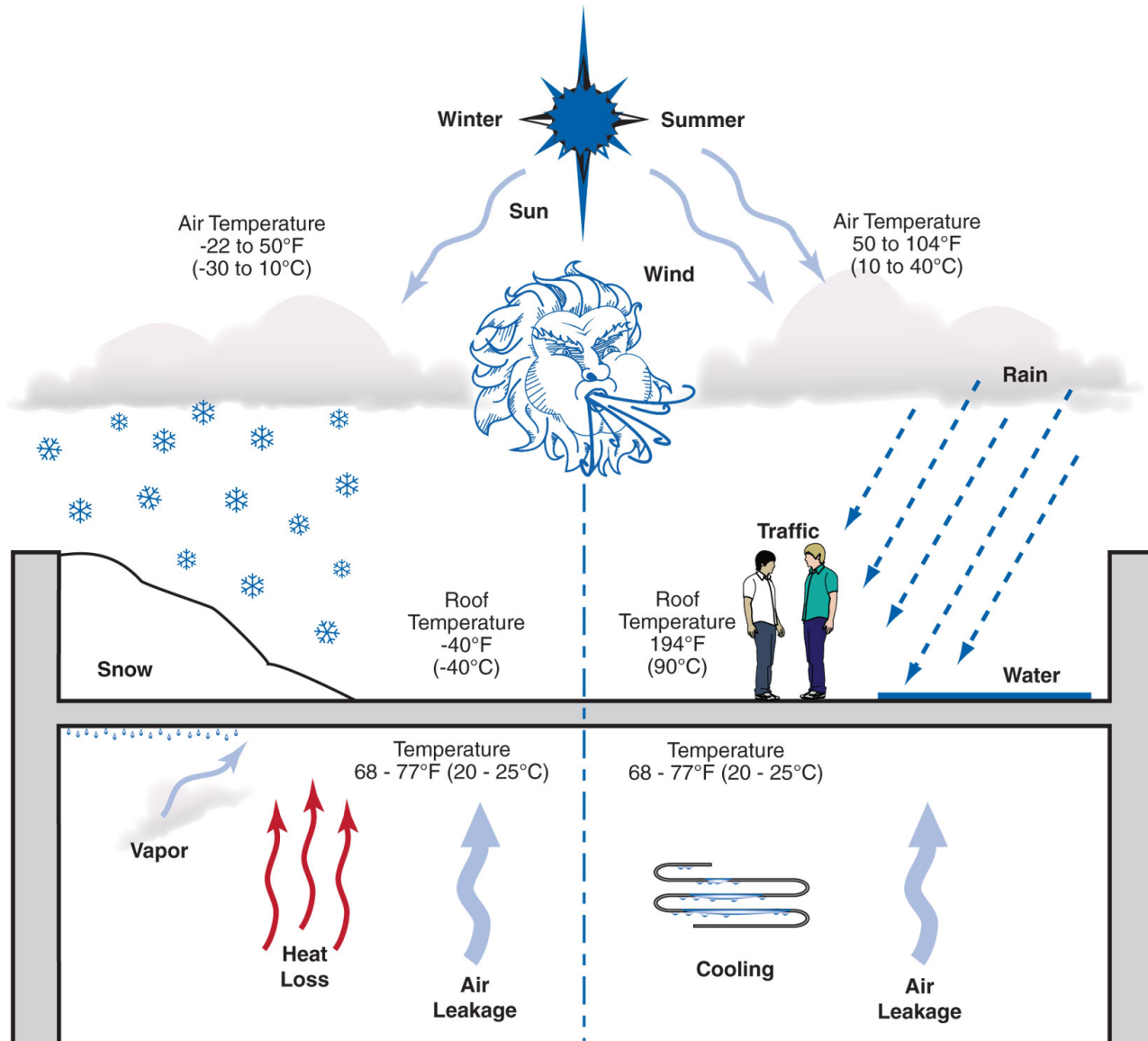

Adapted from Baker, M.; *Roofs*, 1980;
 Courtesy National Research Council of Canada

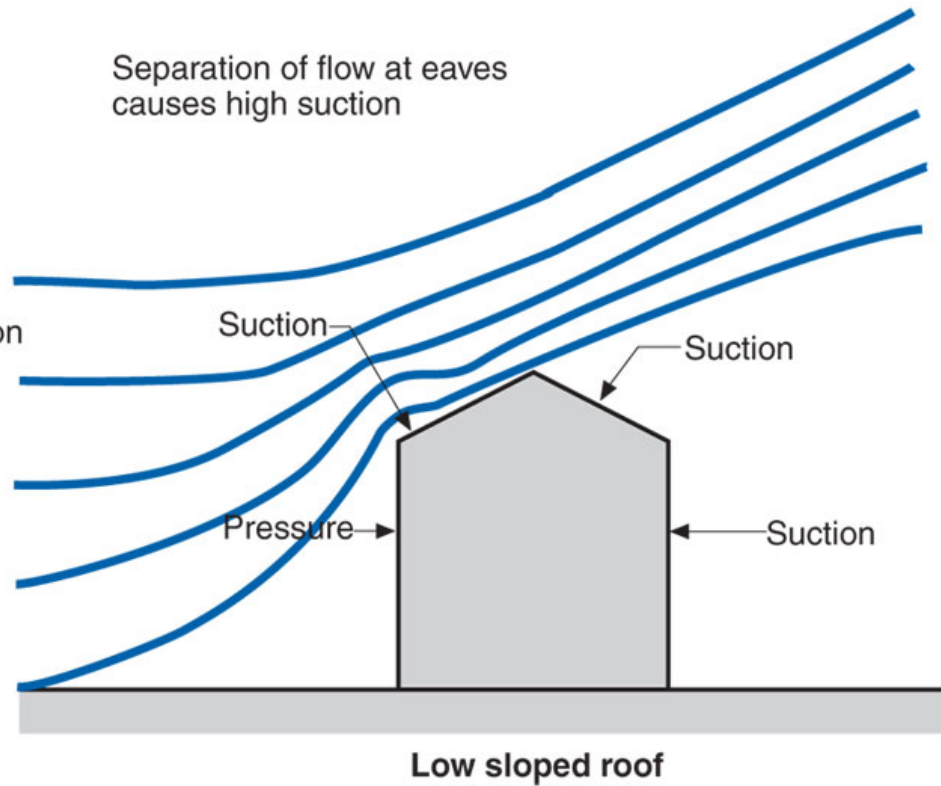
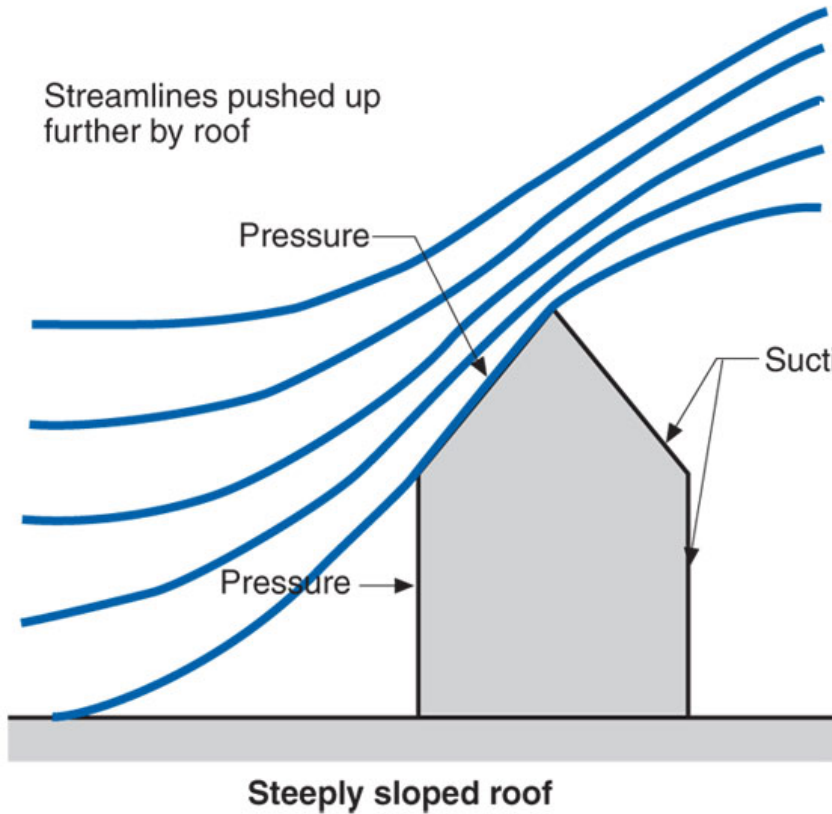

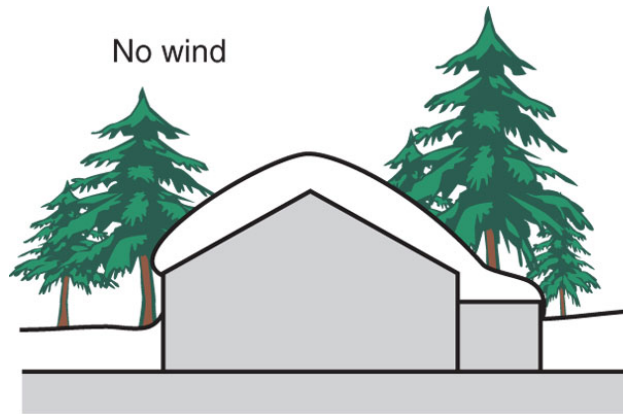

Effect of shelter

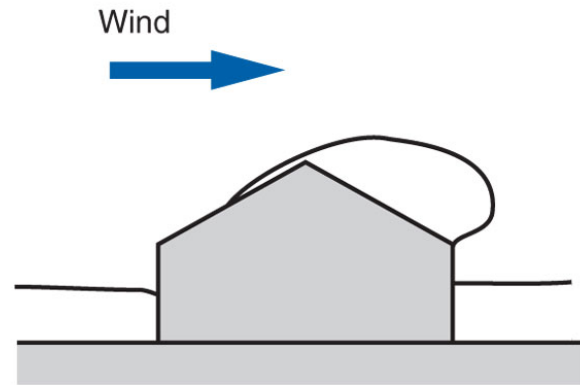

Unbalanced load

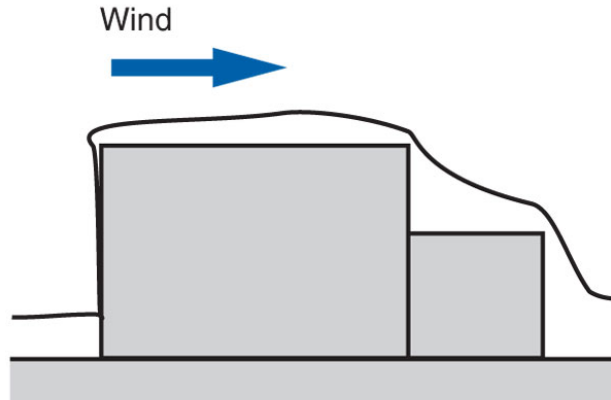

Drift on lower roof

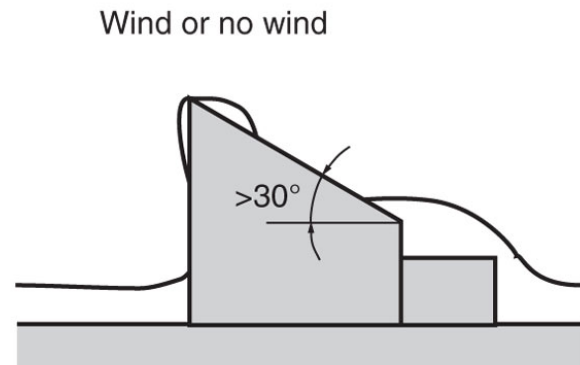

Slide off

From Baker, M.; Roofs, 1980

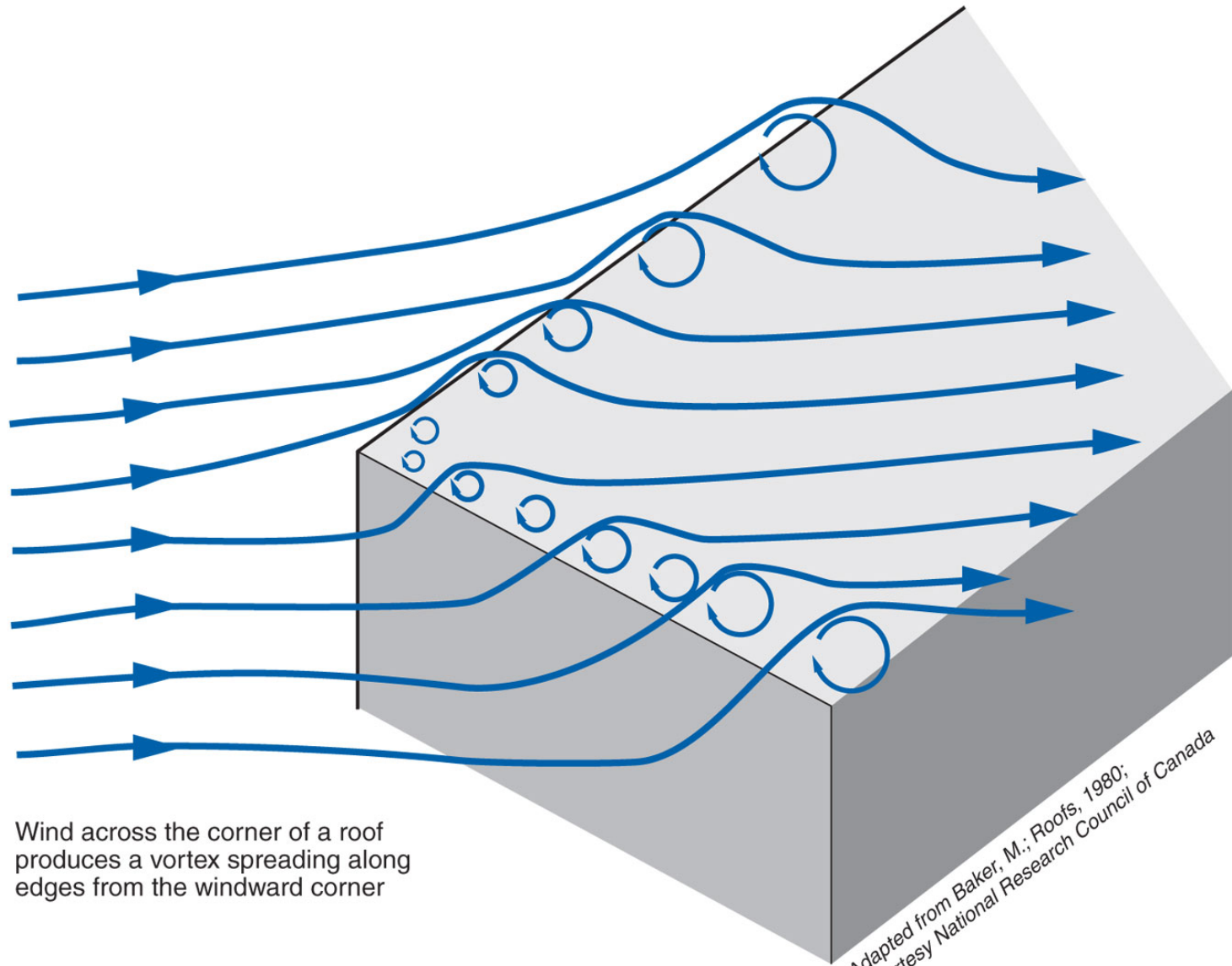

Wind across the corner of a roof produces a vortex spreading along edges from the windward corner

Adapted from Baker, M.; Roofs, 1980;
Courtesy National Research Council of Canada

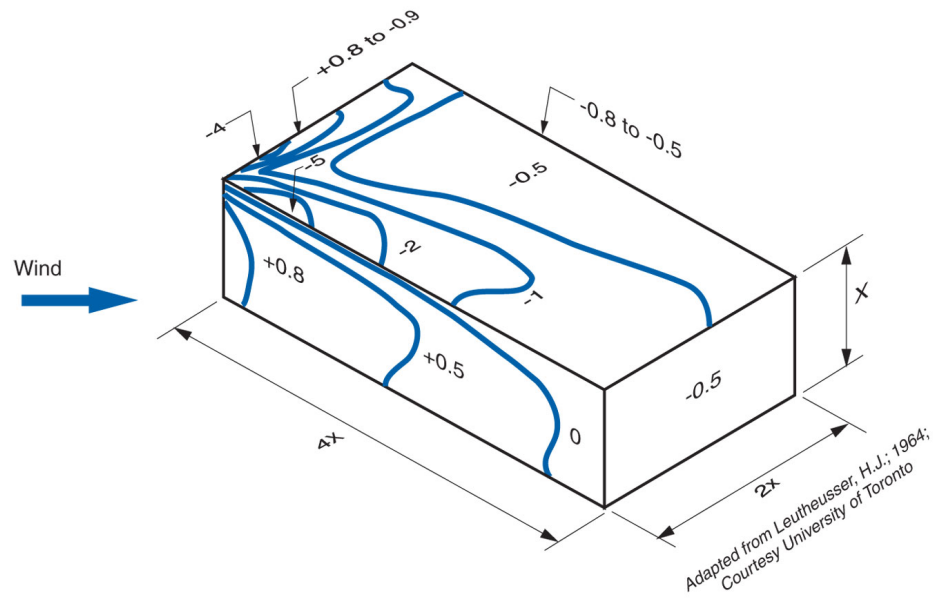
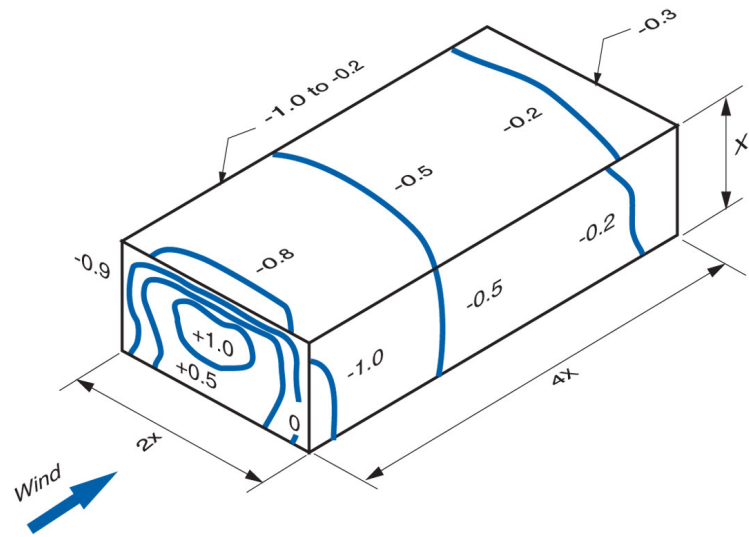

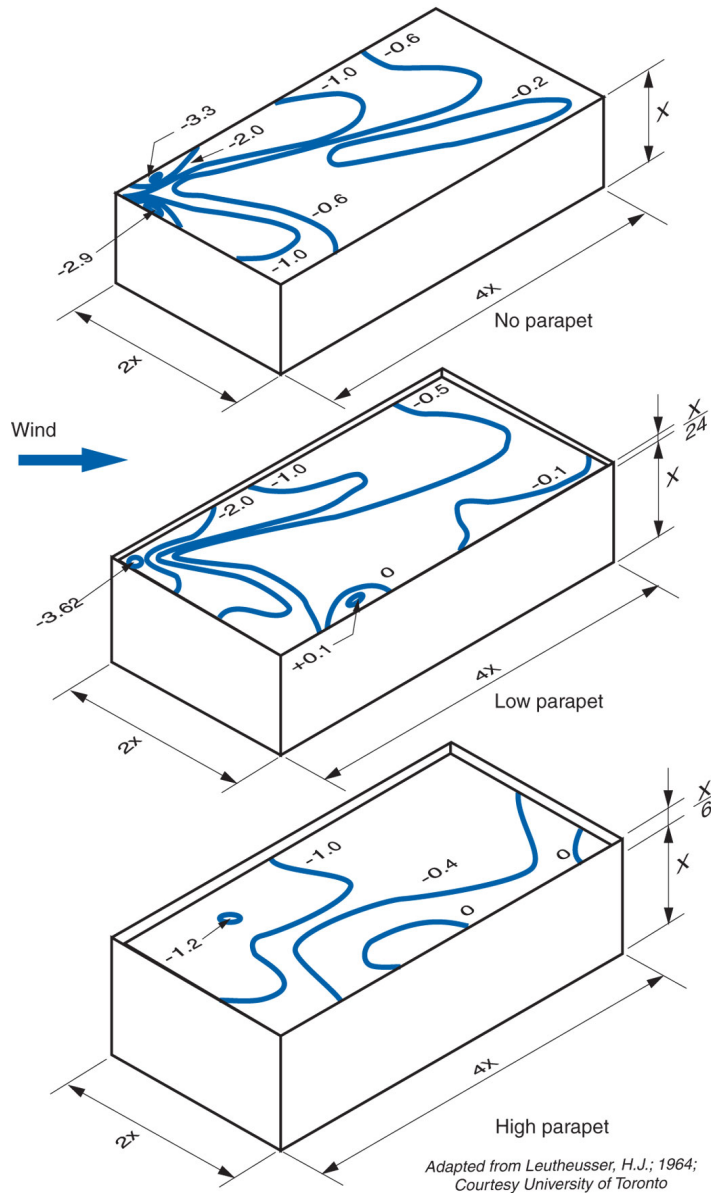

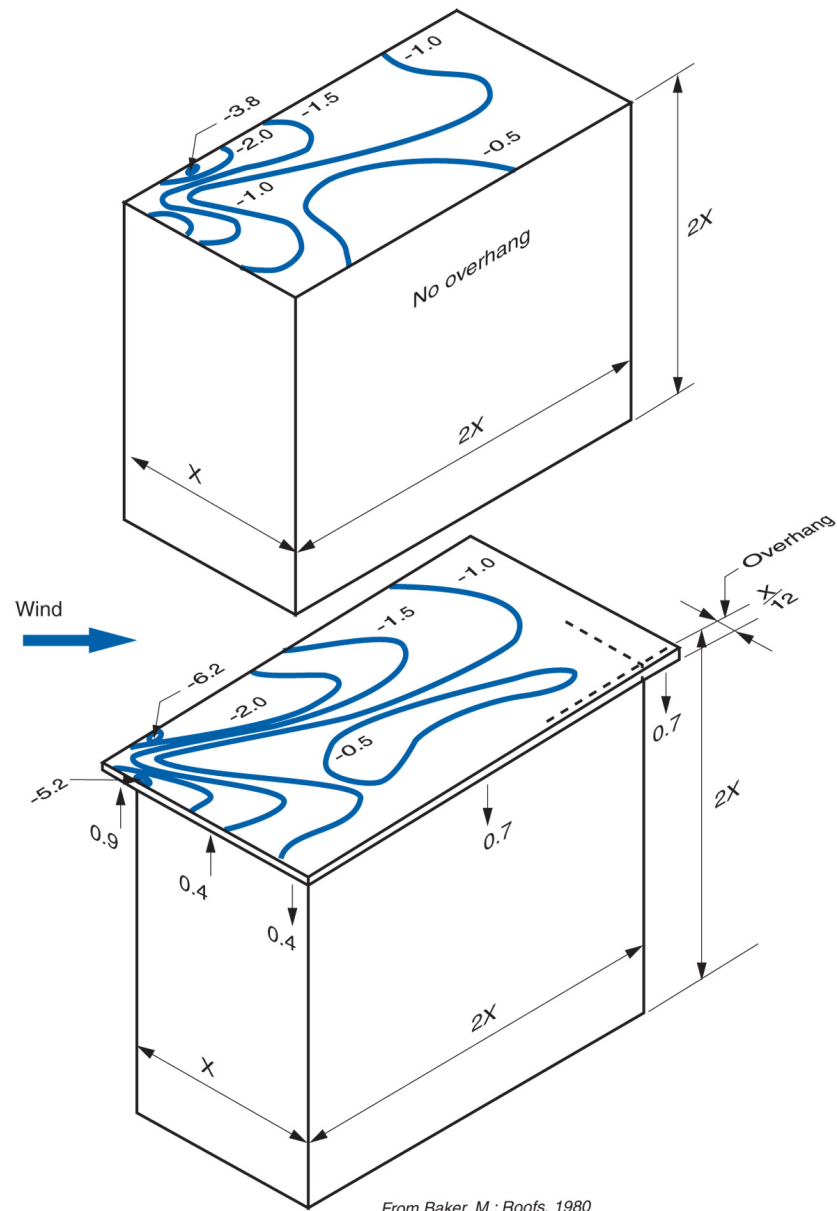

From Baker, M.; Roofs, 1980

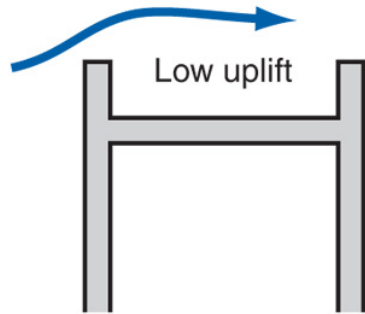

Flat roof with parapets
blow-off hazard: low
slippage hazard: low

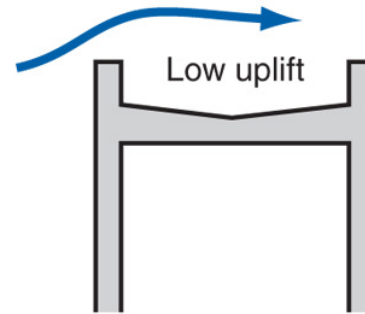

Sloped roof with parapets
blow-off hazard: low
slippage hazard: medium

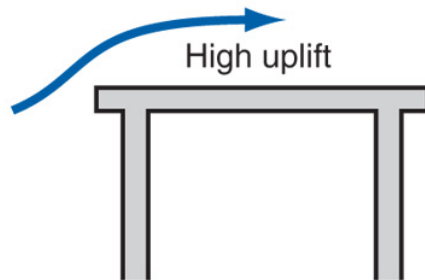

Flat roof or overhang
blow off hazard: high
slippage hazard: low

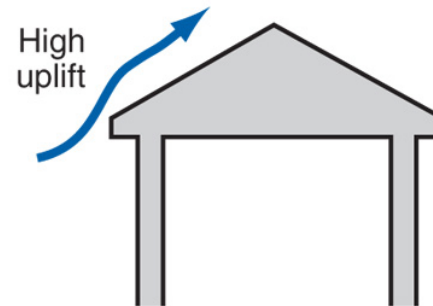

Outward sloping roof
blow-off hazard: high
slippage hazard: high

From Baker, M.; Roofs, 1980

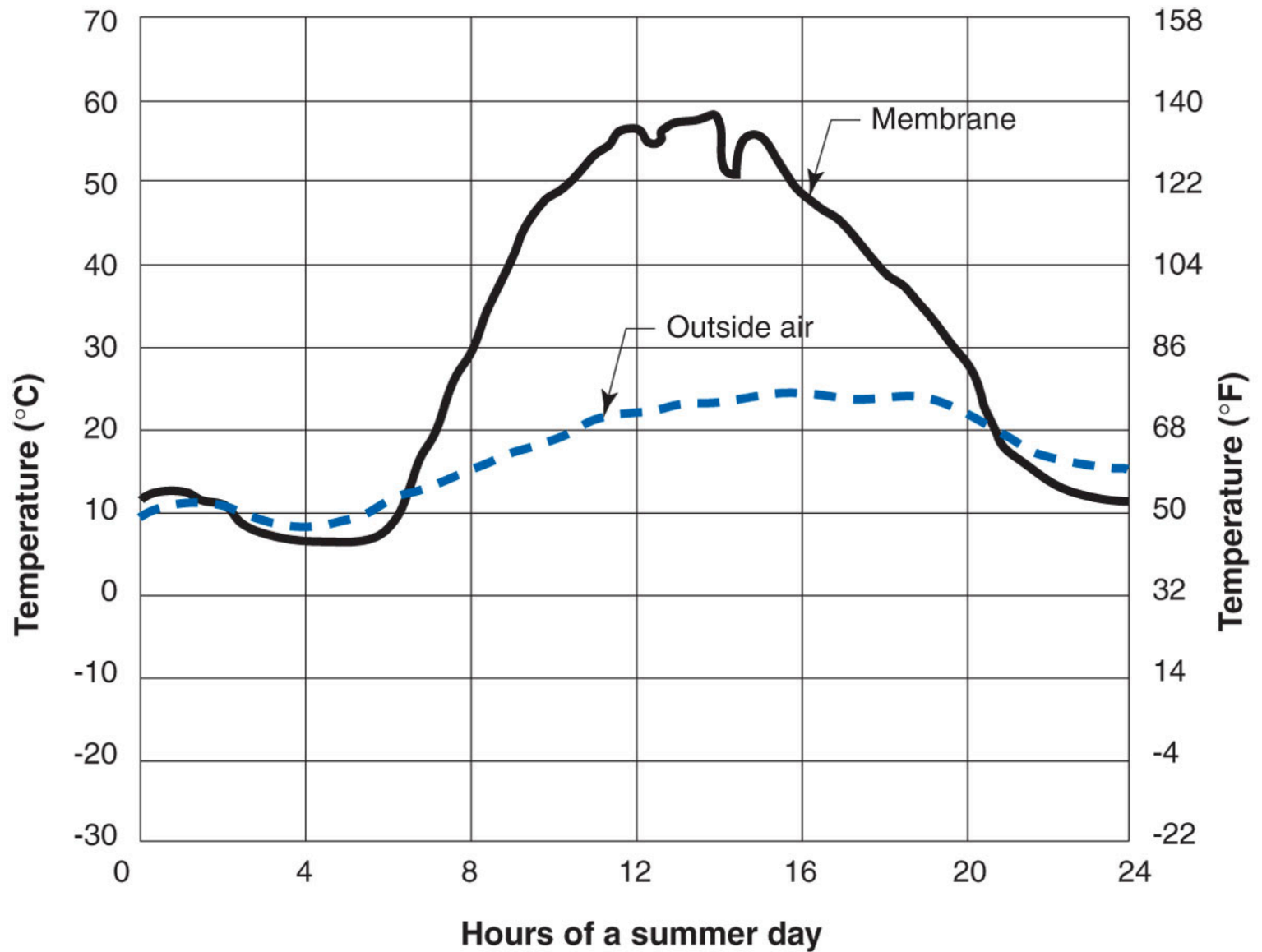

Hours of a summer day

From Baker, M.; Roofs, 1980

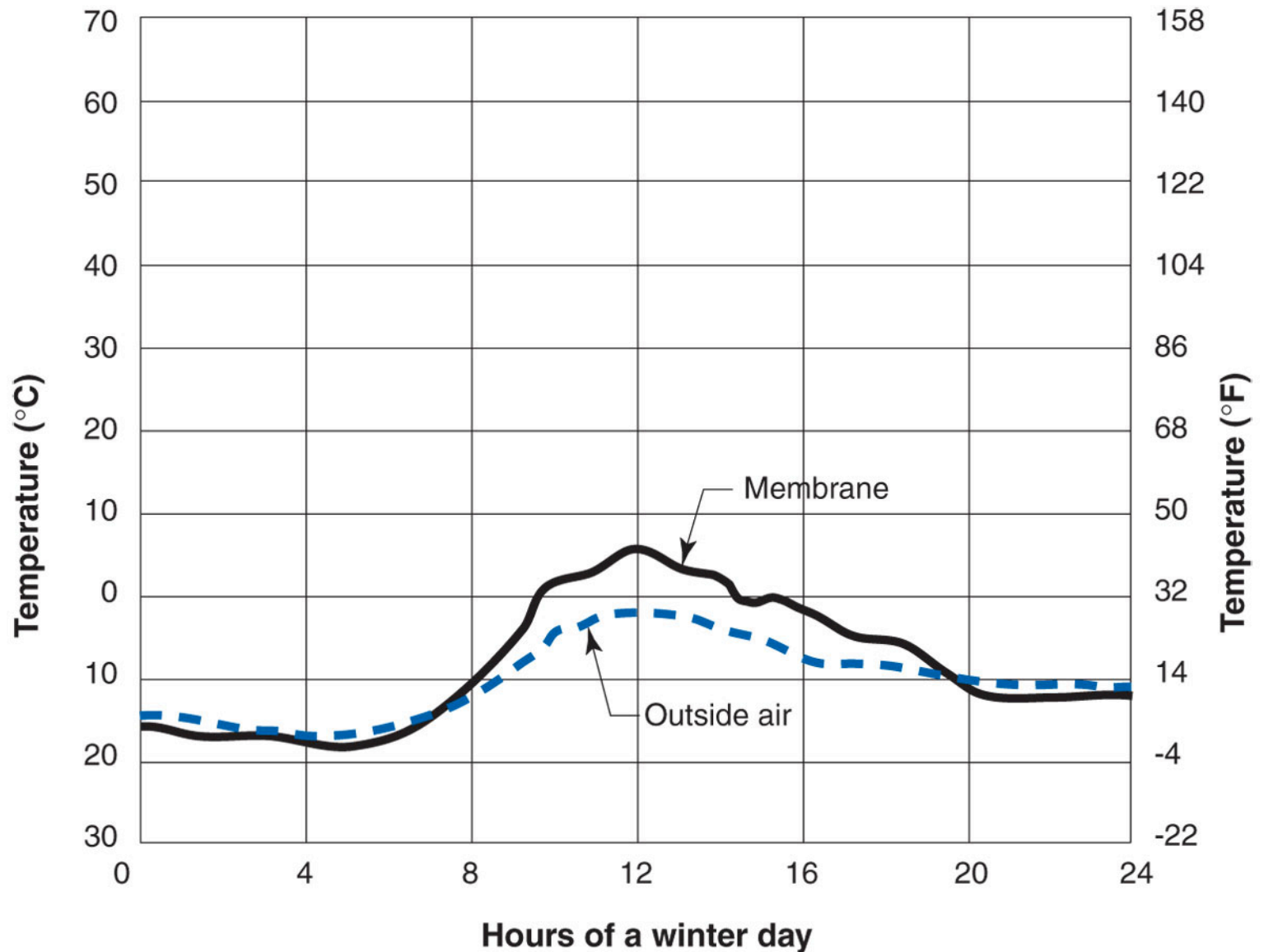

Hours of a winter day

From Baker, M.; Roofs, 1980

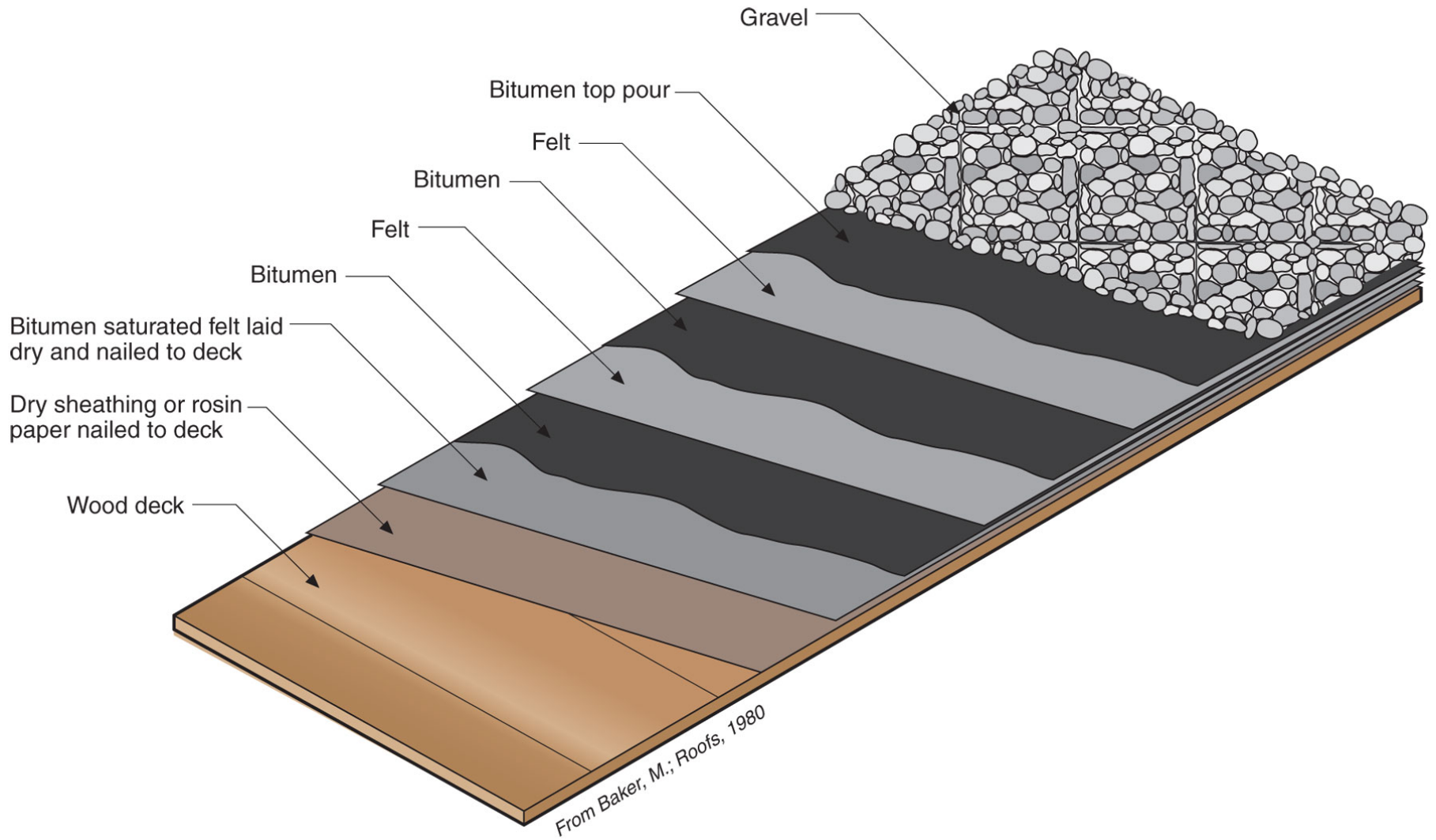

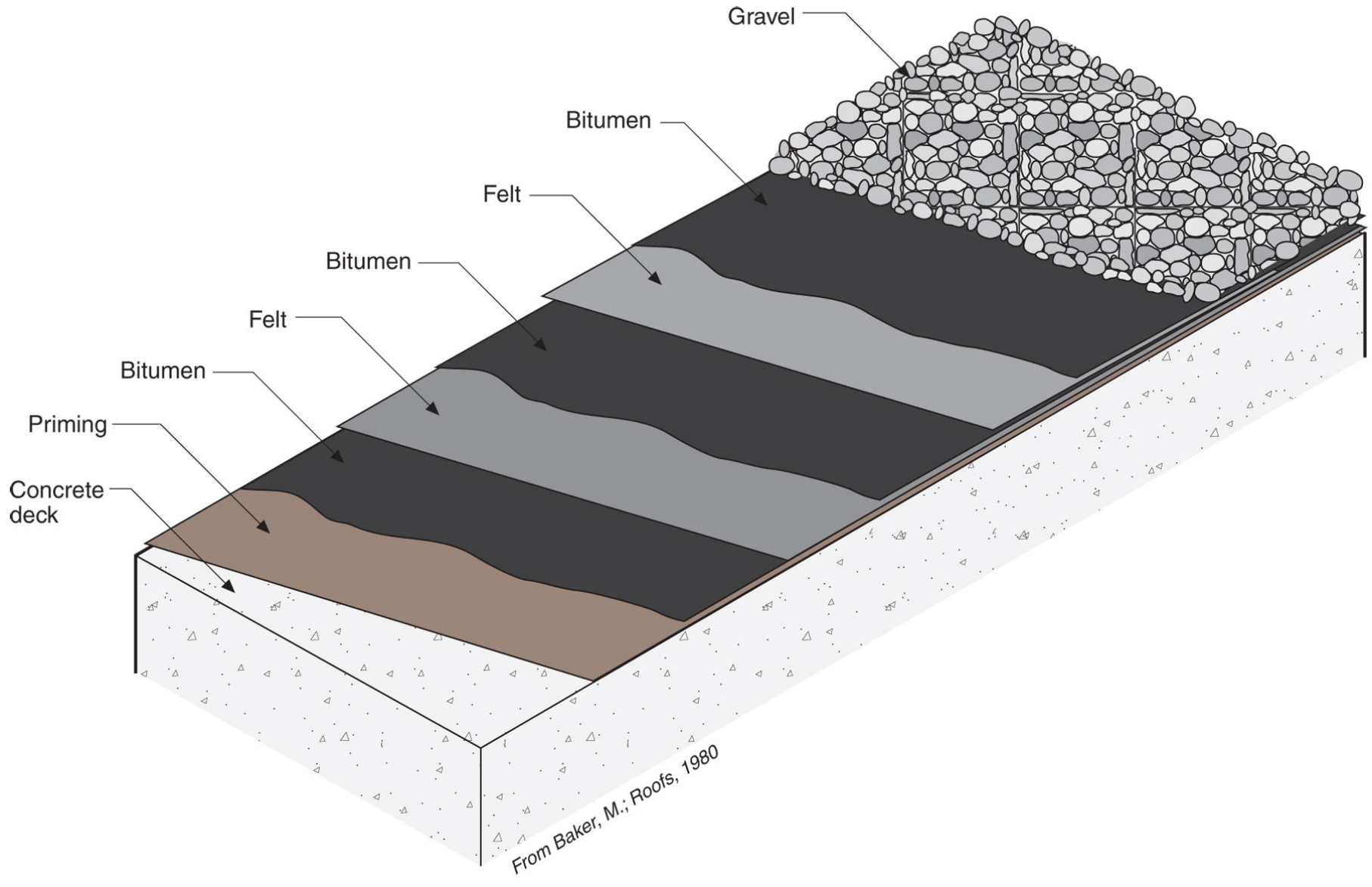

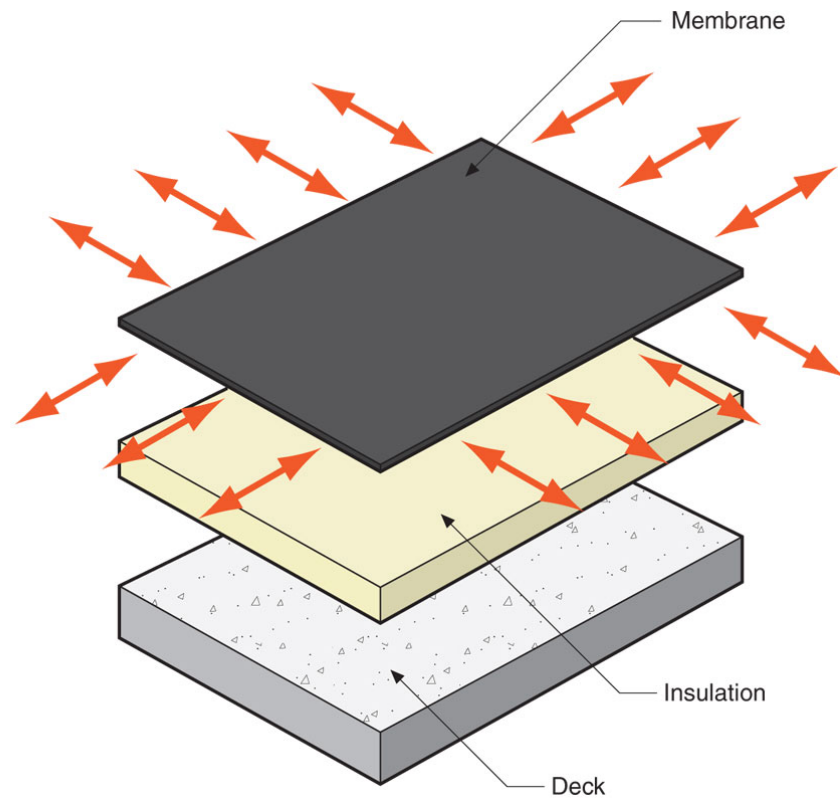
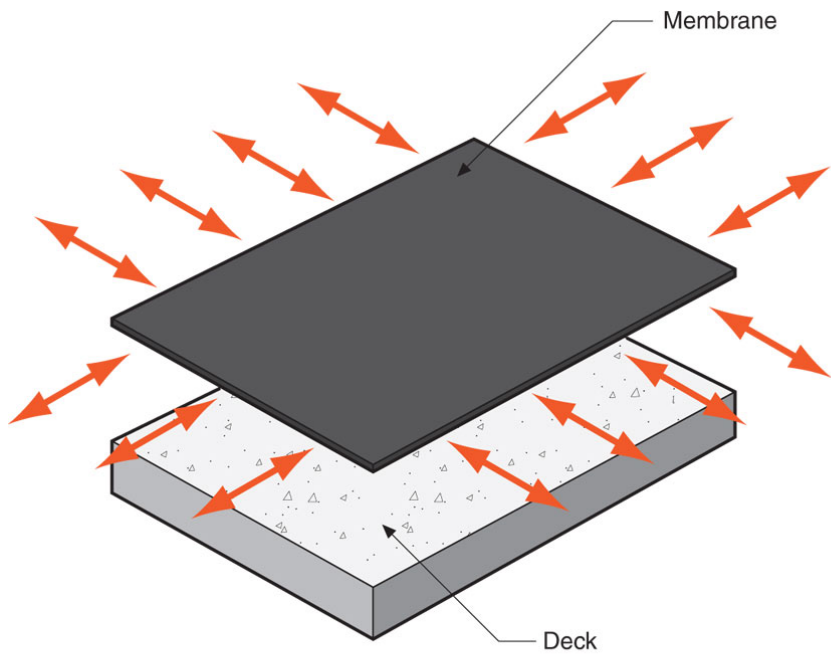

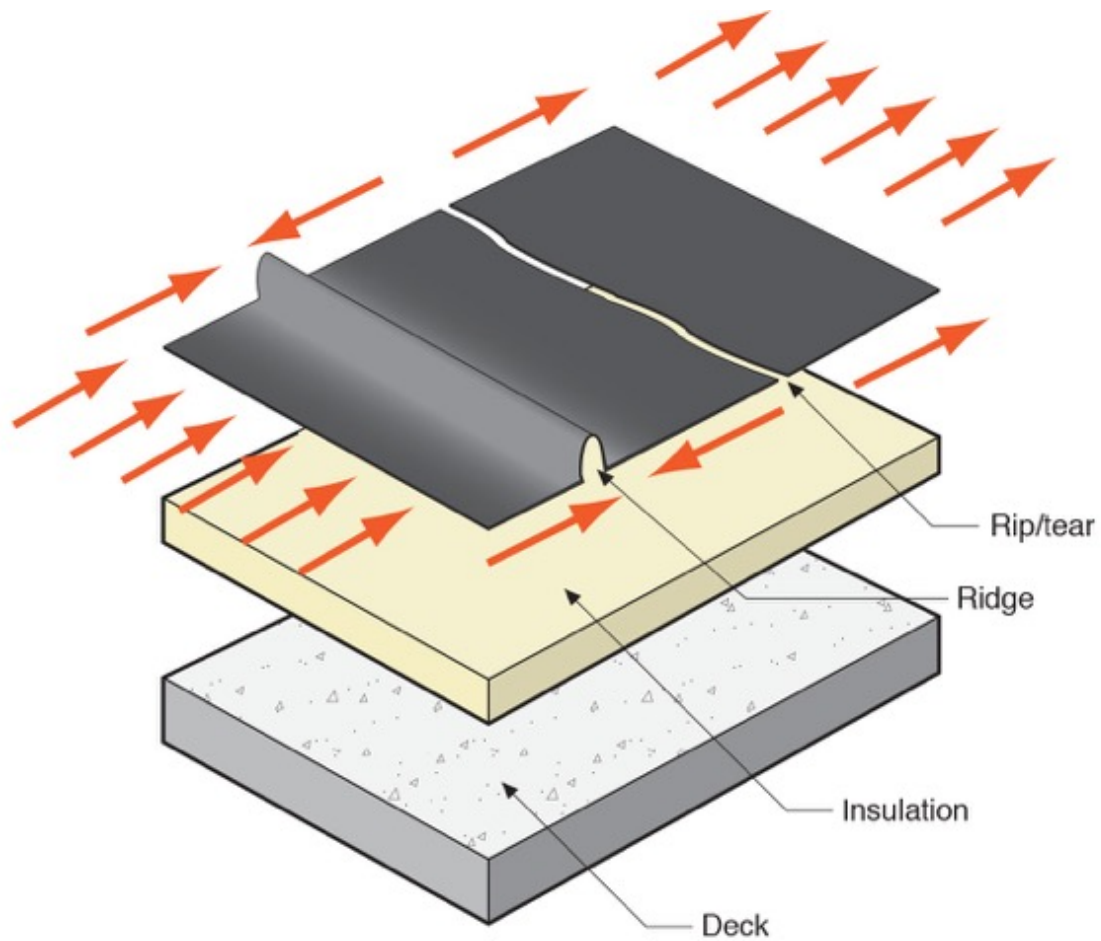



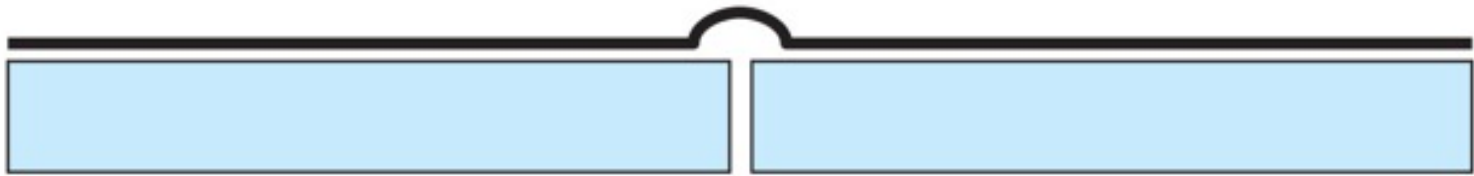
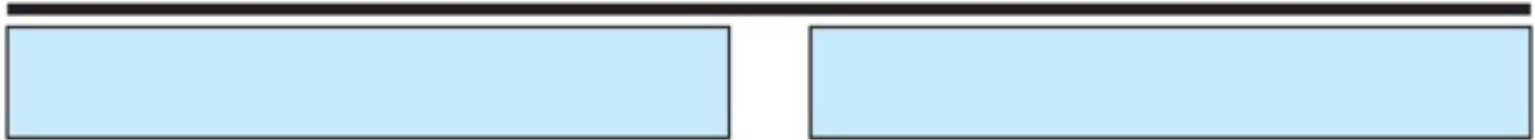

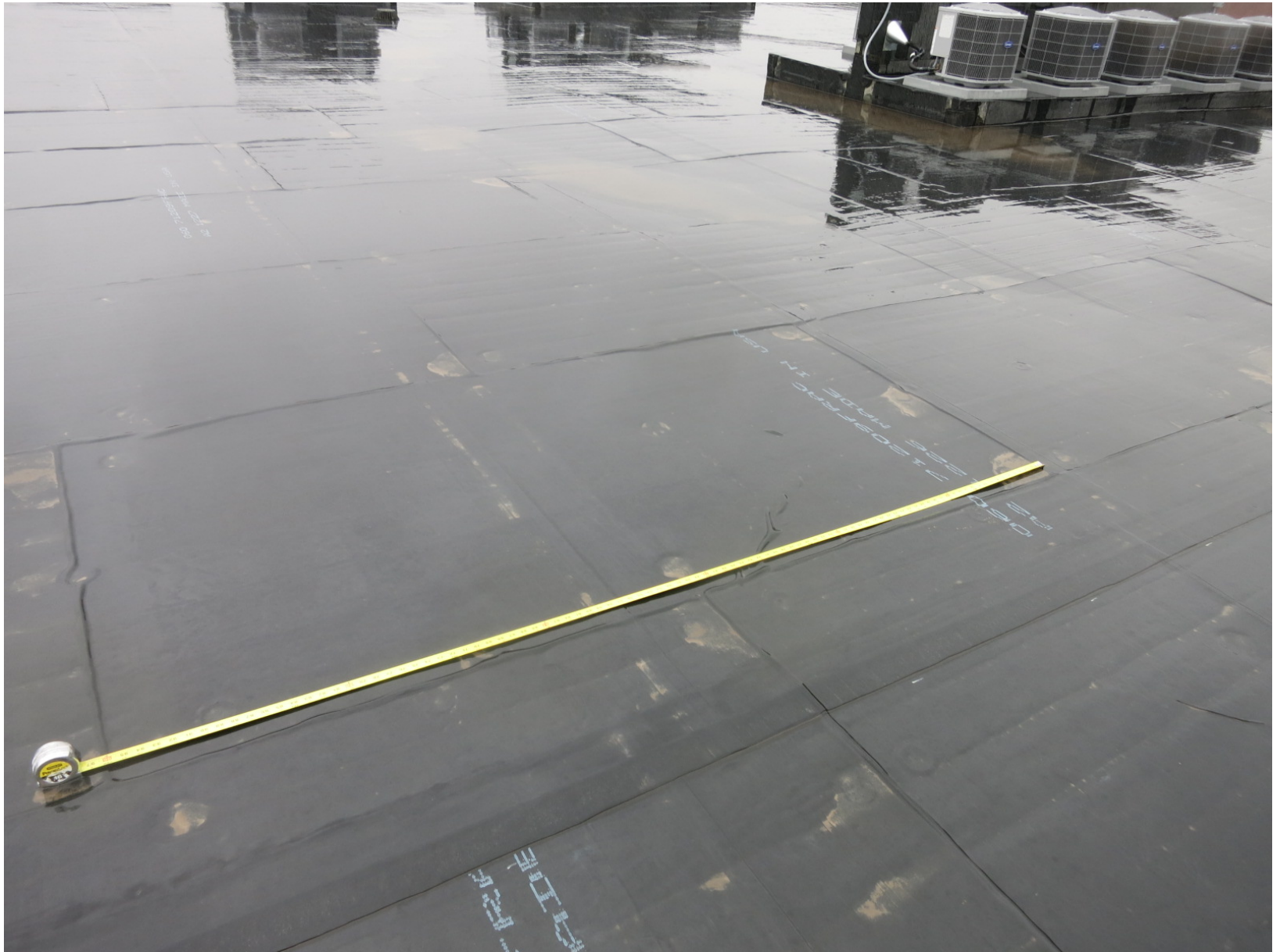

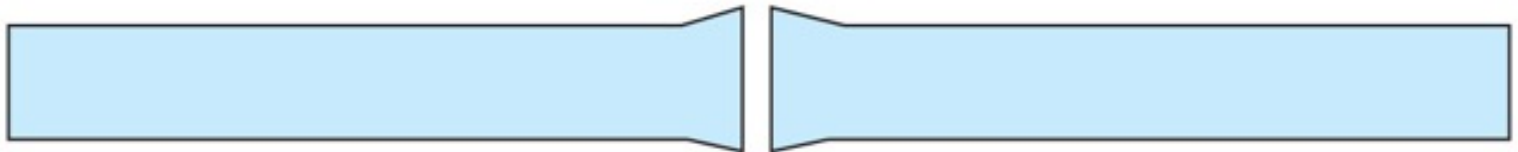
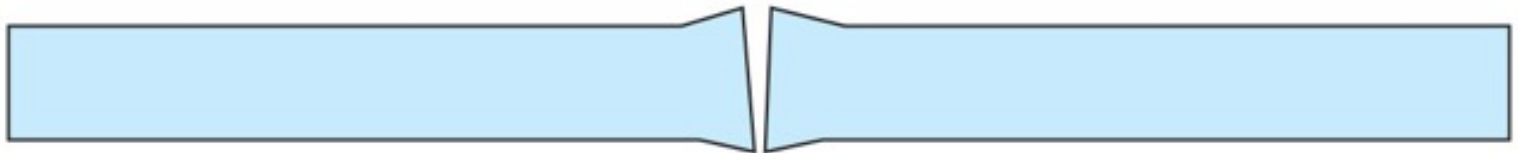
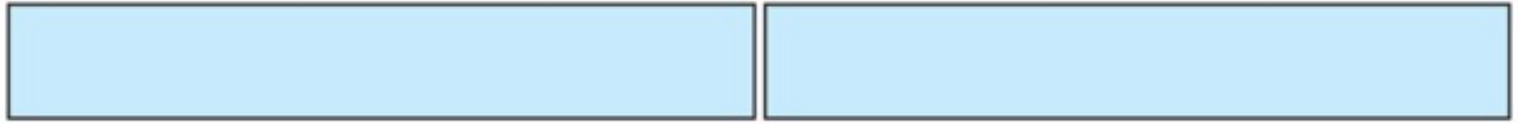

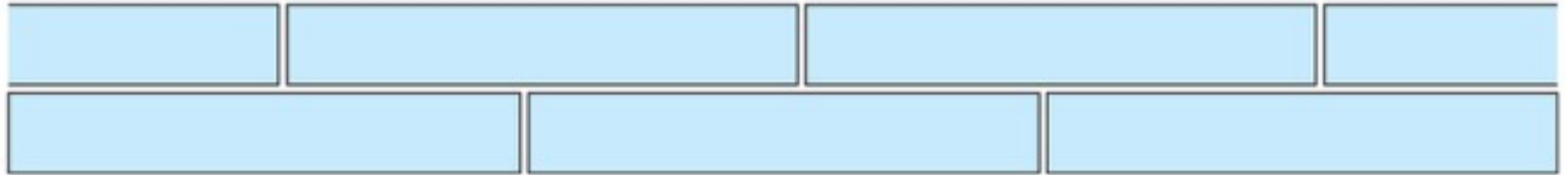





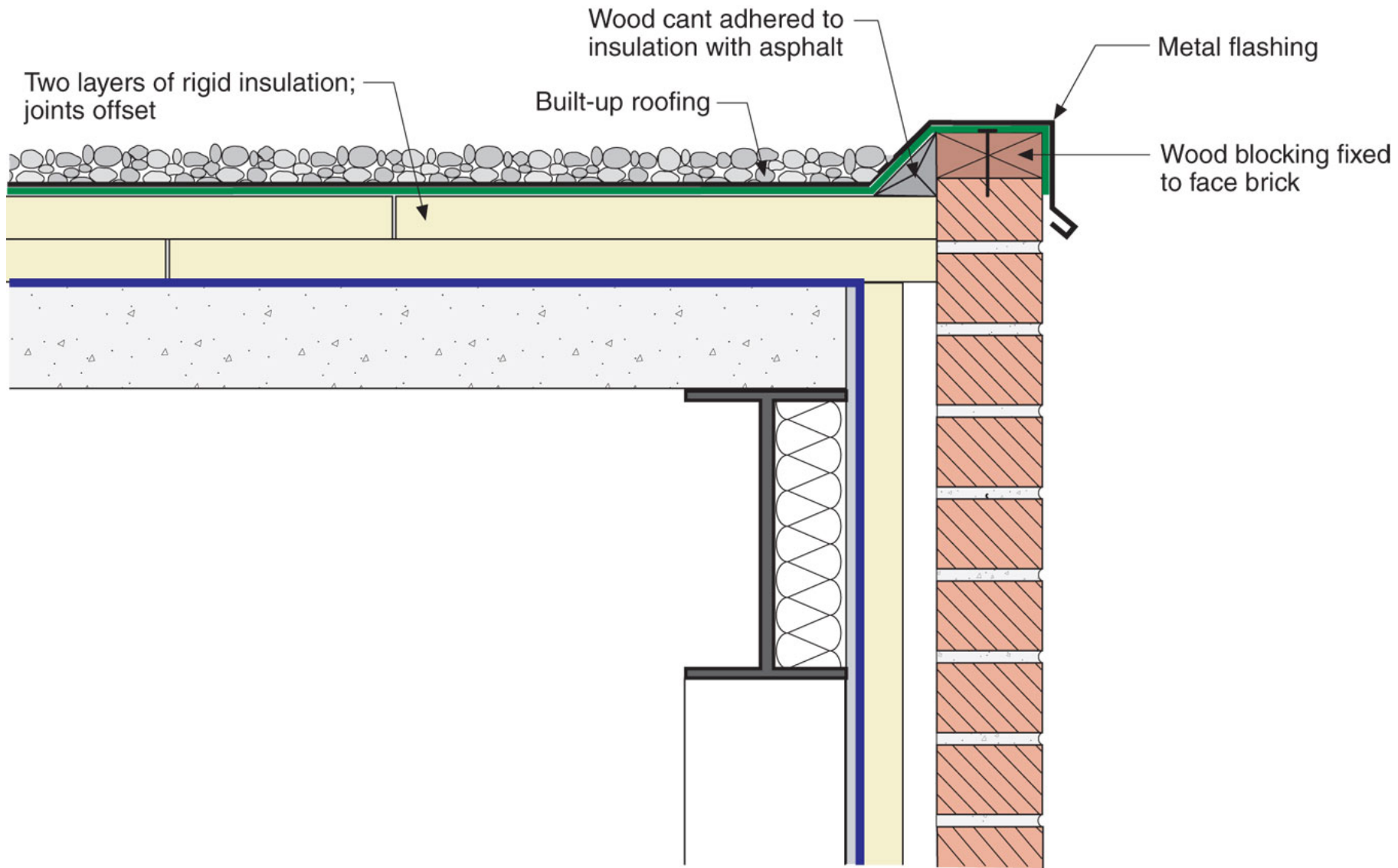

Adapted from Baker, M.; *Roofs*, 1980

Insulation moved because of poor adhesion to deck and between layers

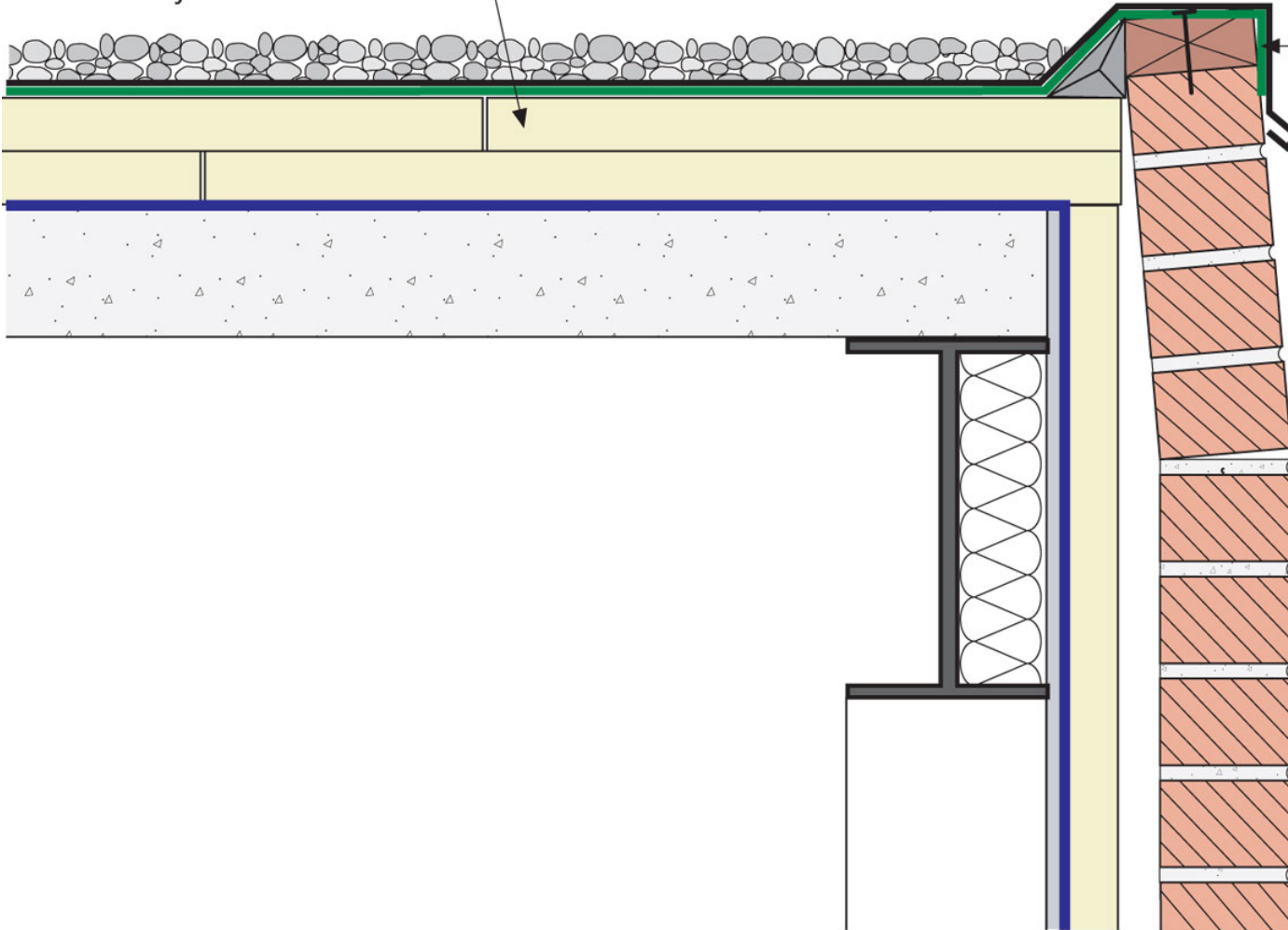

Top four courses of brick and wood blocking pulled inward by contracting membrane

*Adapted from Baker, M.; Roofs, 1980;
Courtesy National Research Council of Canada*

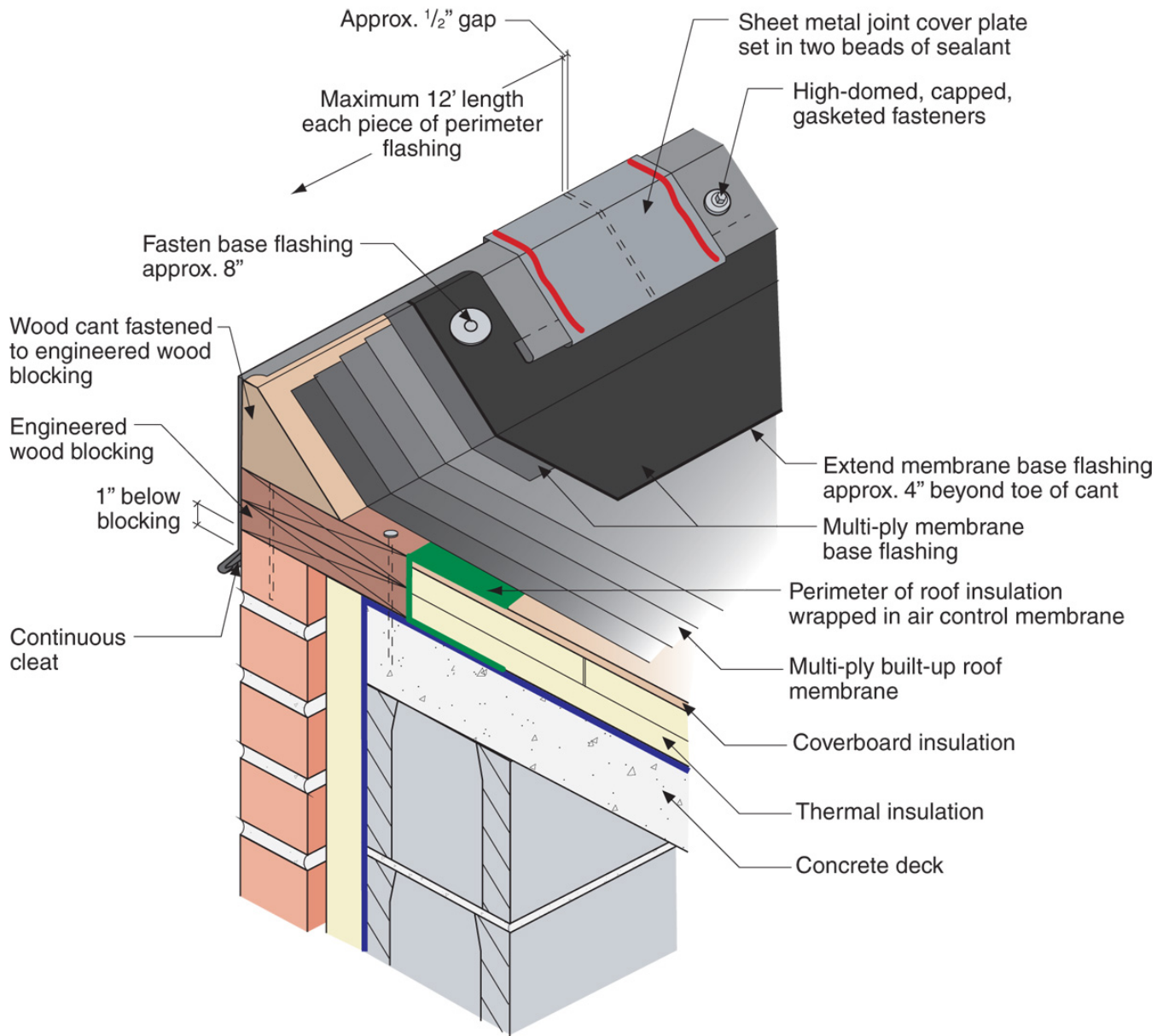

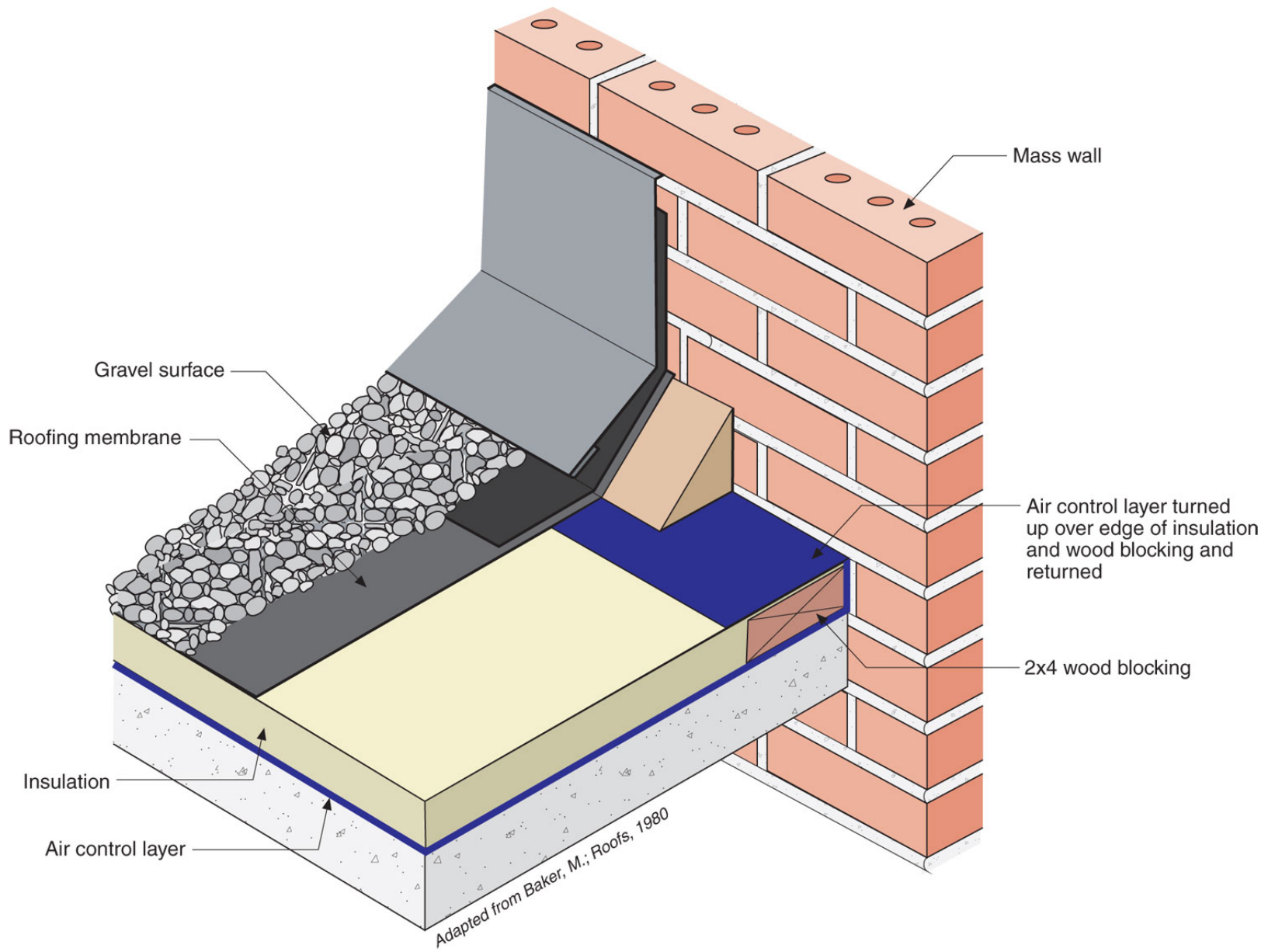

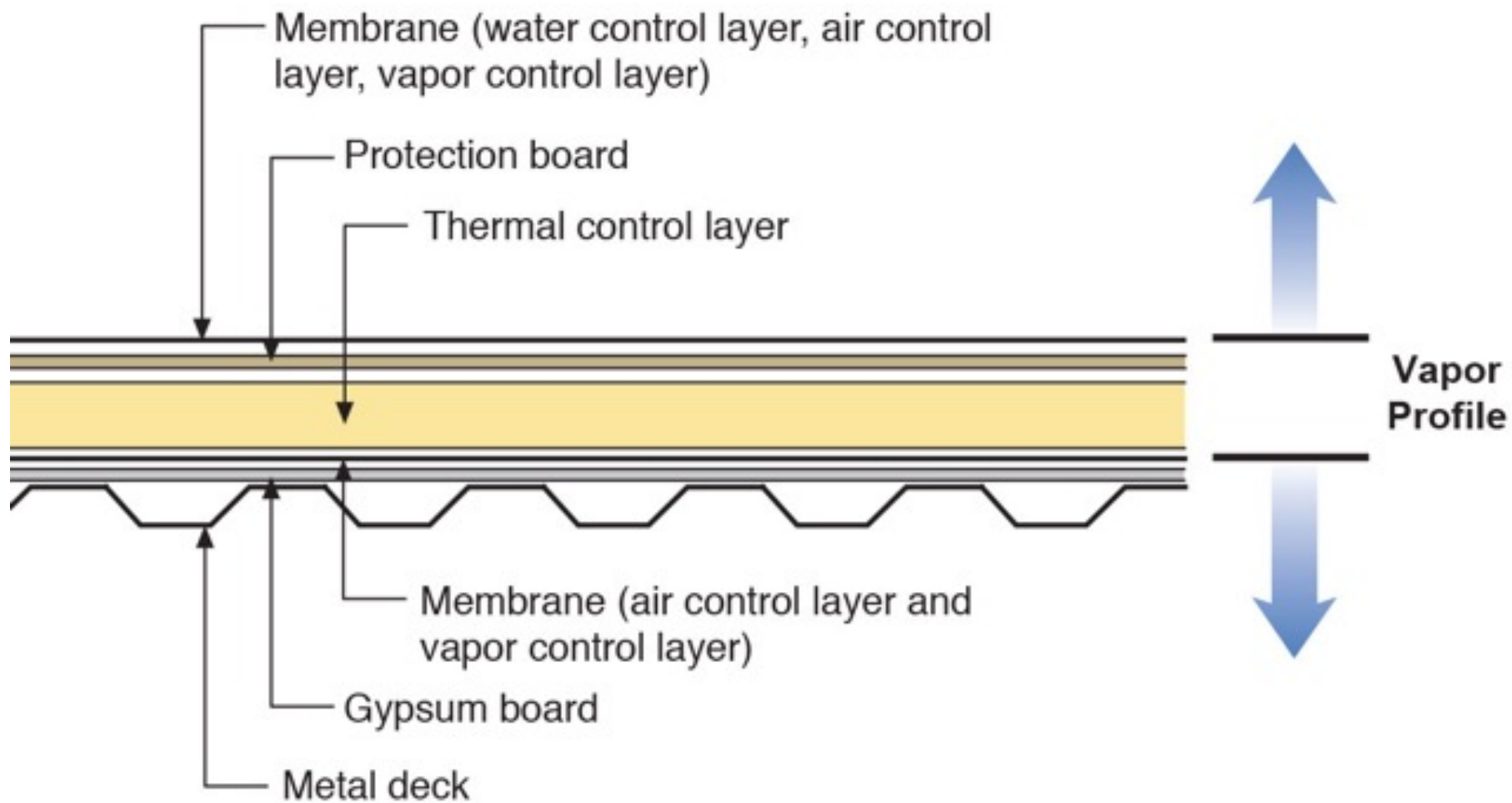

Supply air into occupied zone returns to AHU by passing through deliberately porous dropped ceiling or through return grilles installed in dropped ceiling

Air handling unit extracts air from dropped ceiling, conditions it and injects it into the occupied zones via supply ductwork

Dropped ceiling depressurized by air handling units extracting air from dropped ceiling

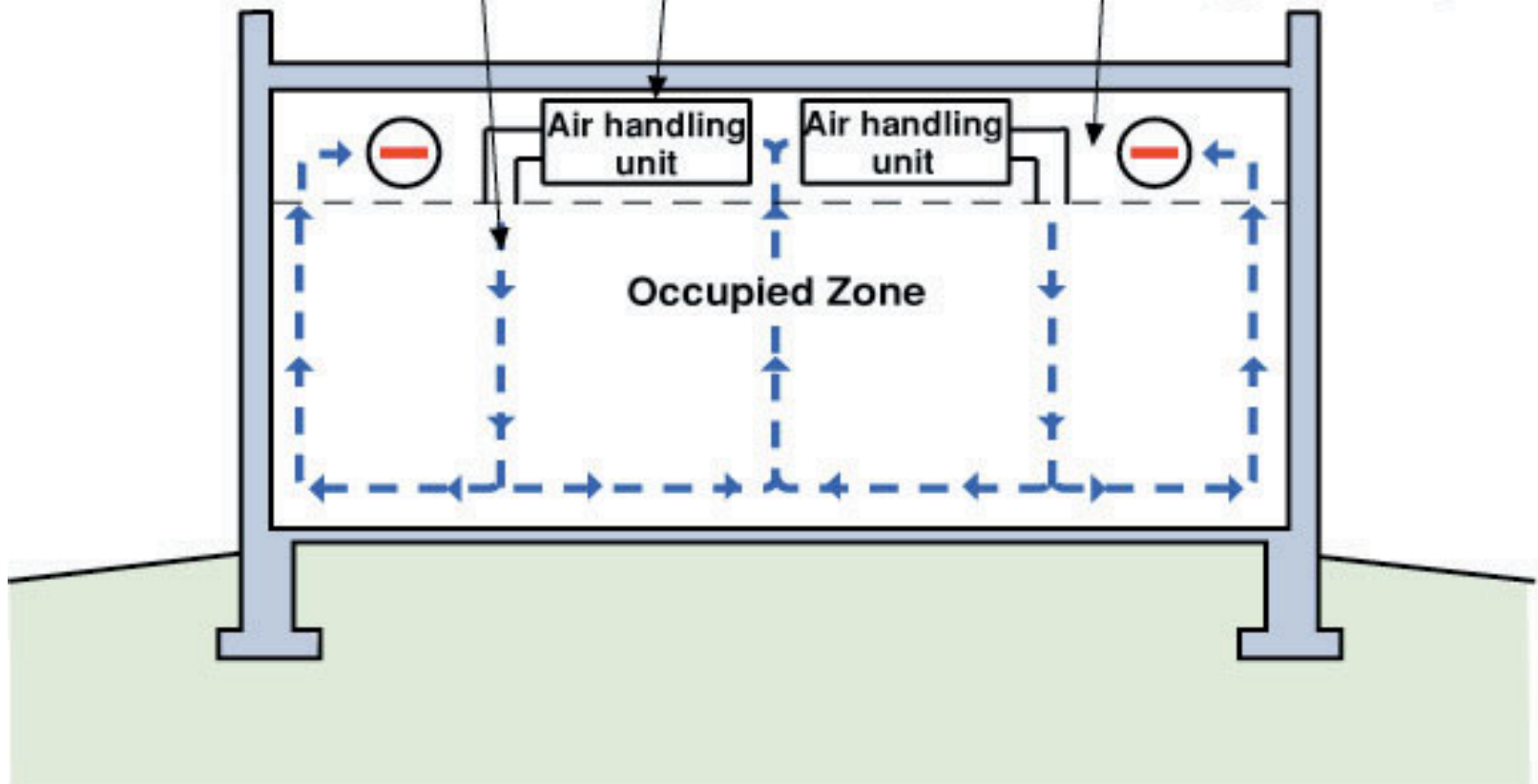

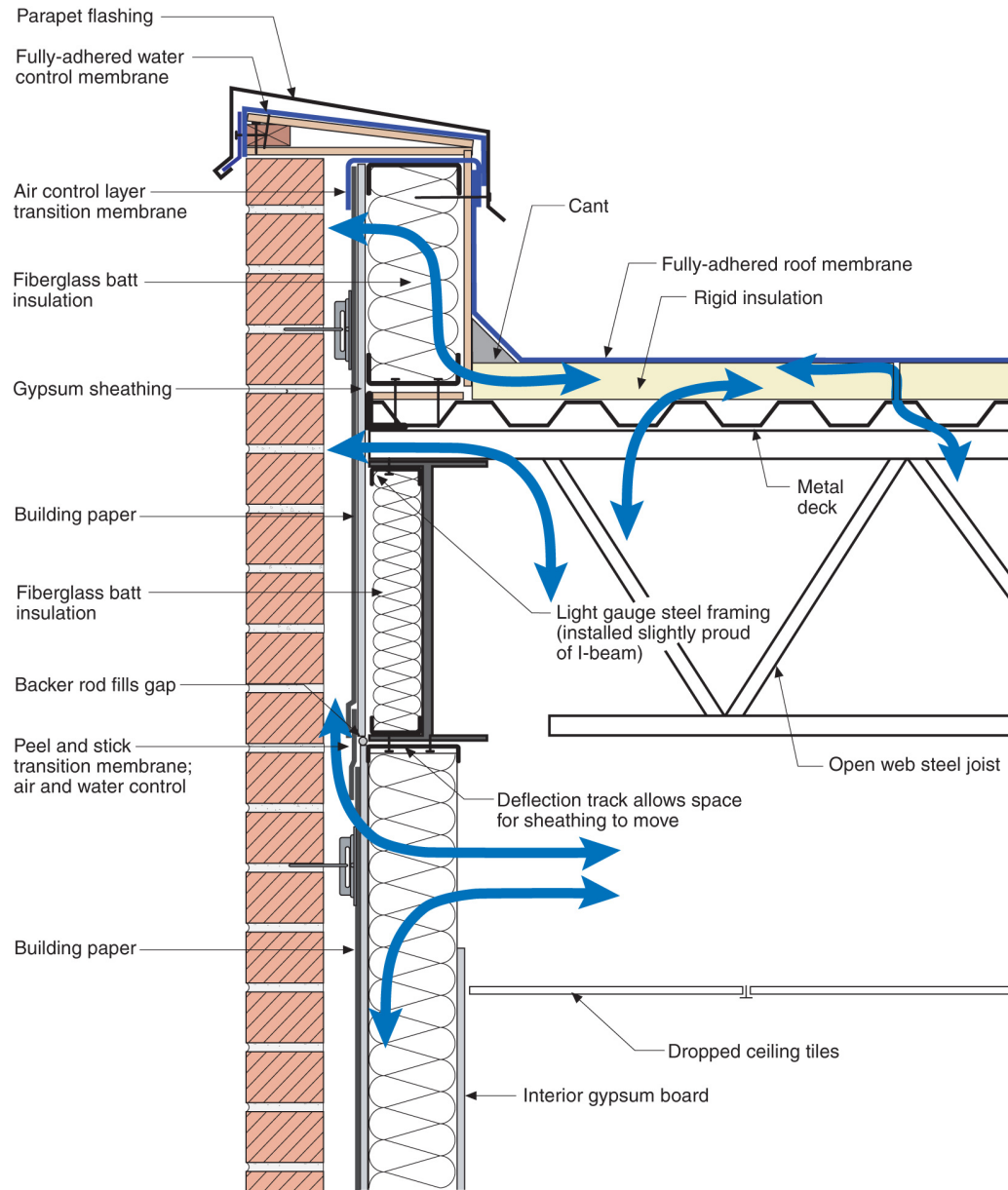

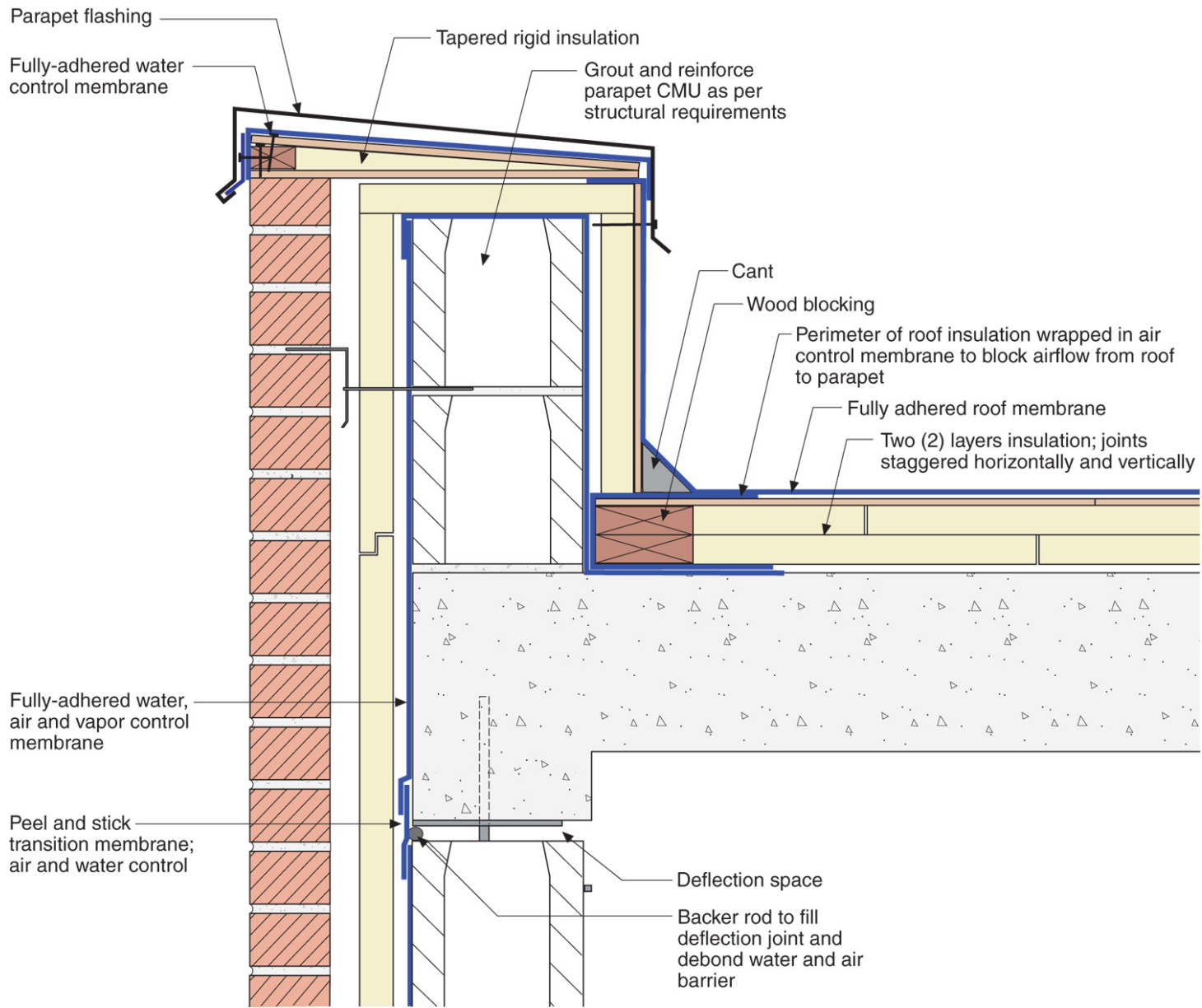

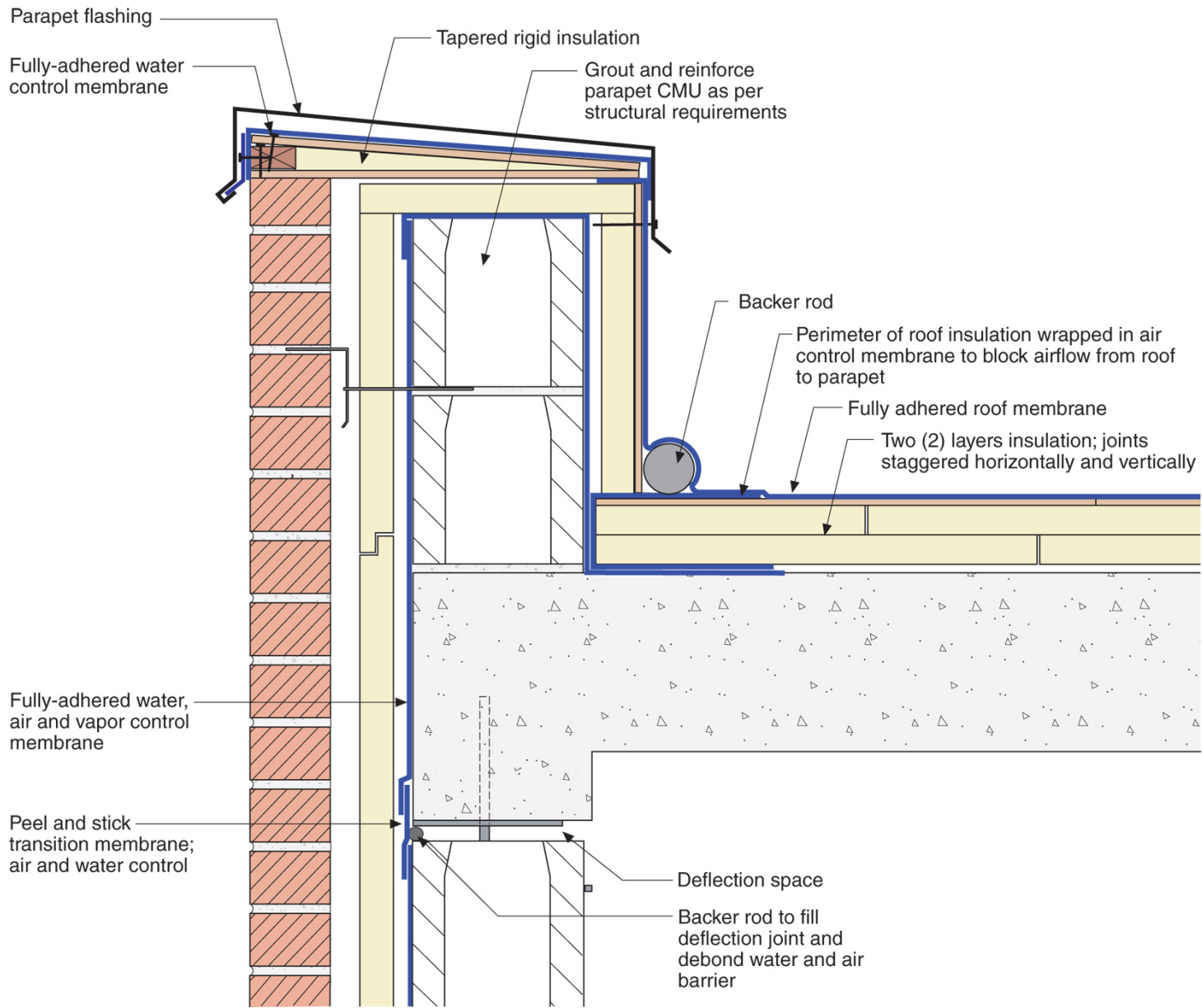

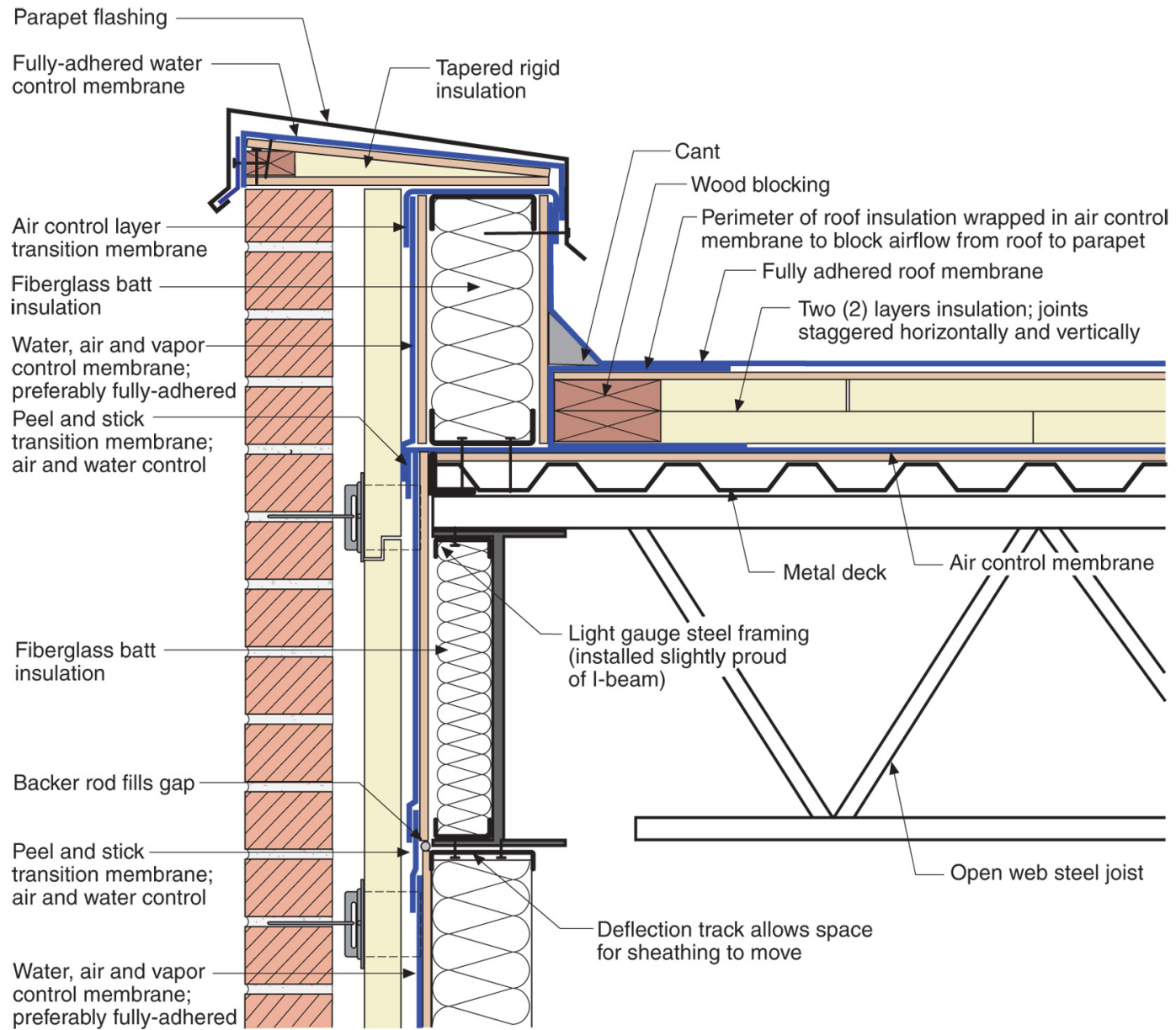

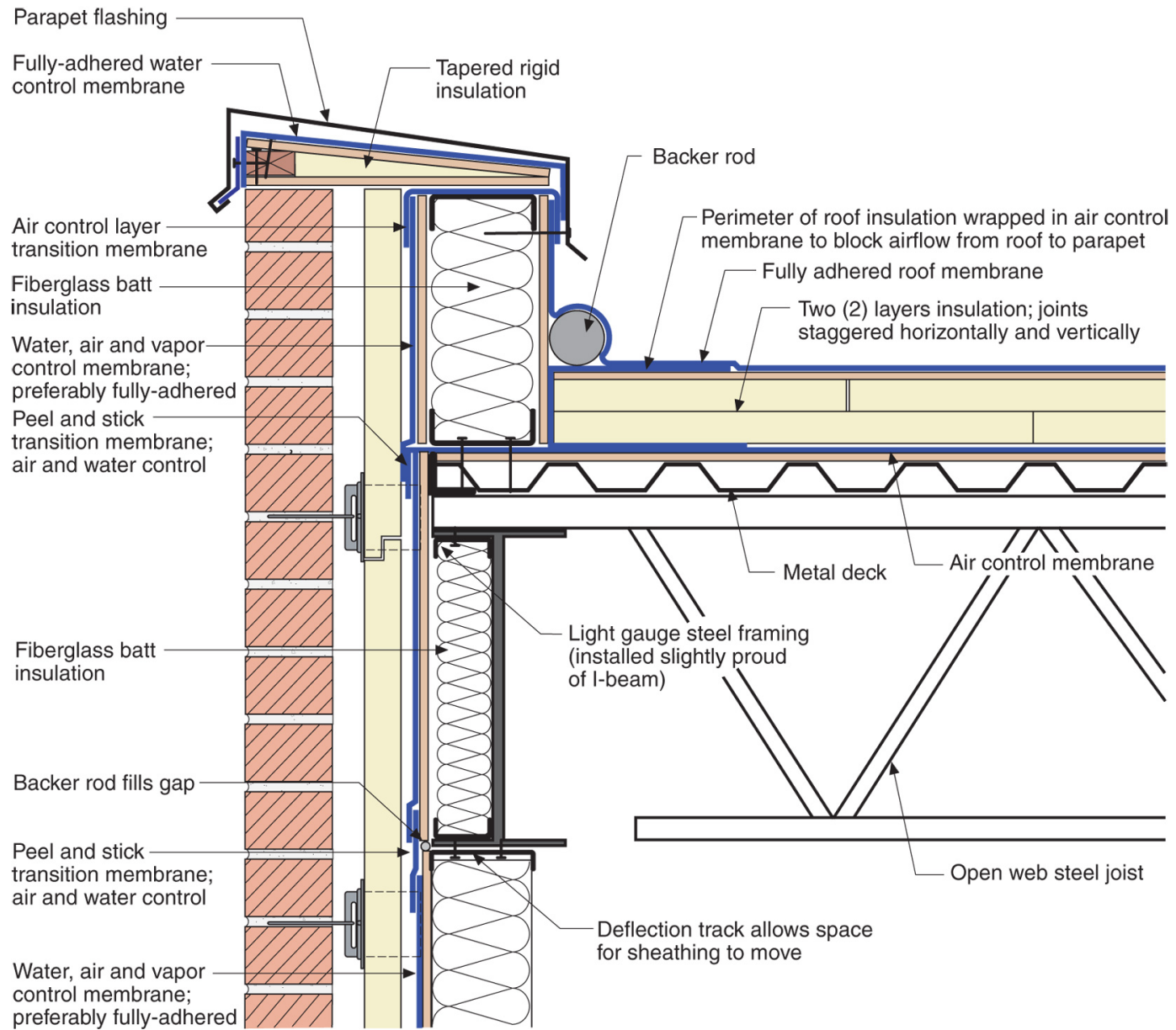

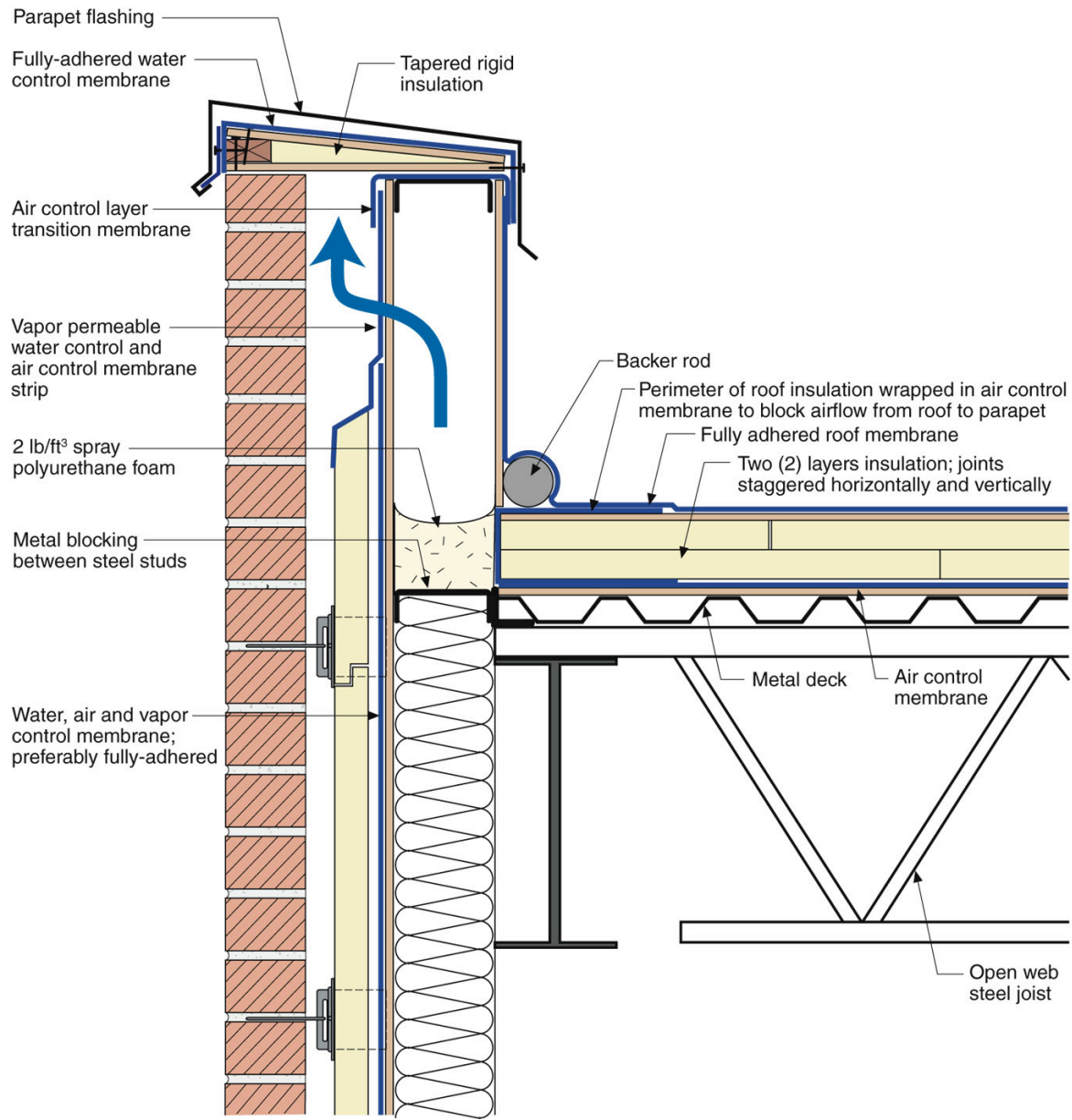

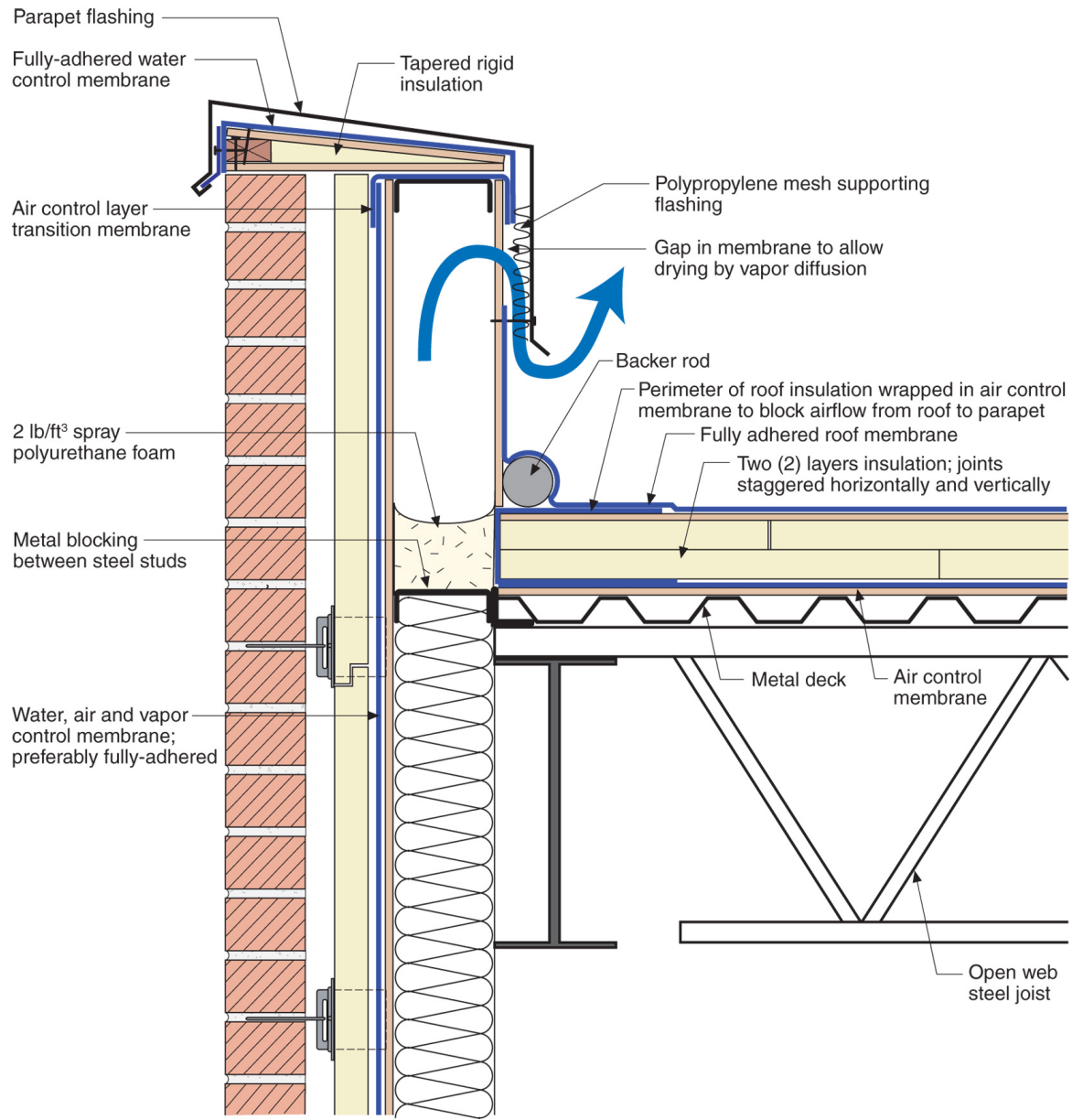

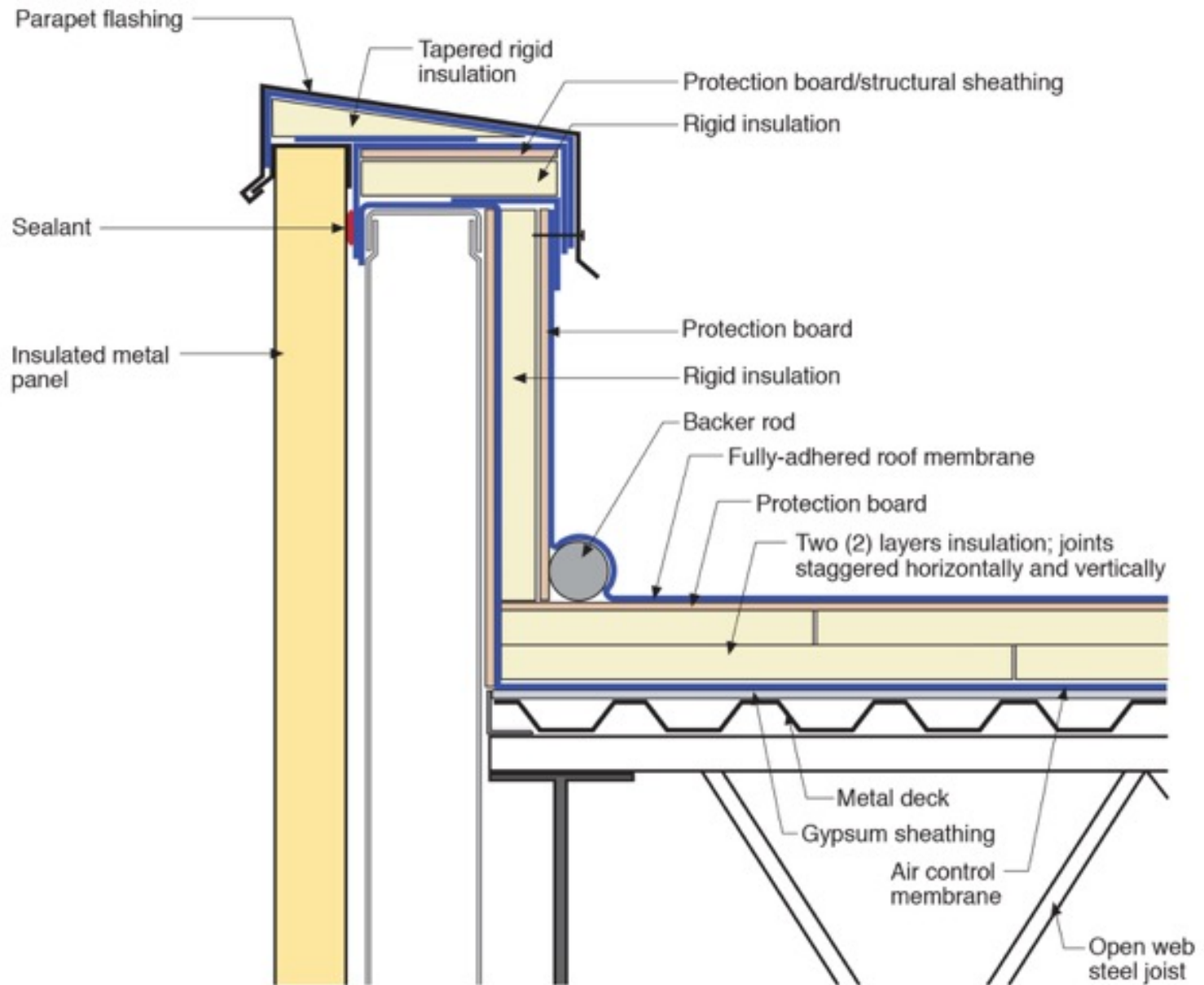

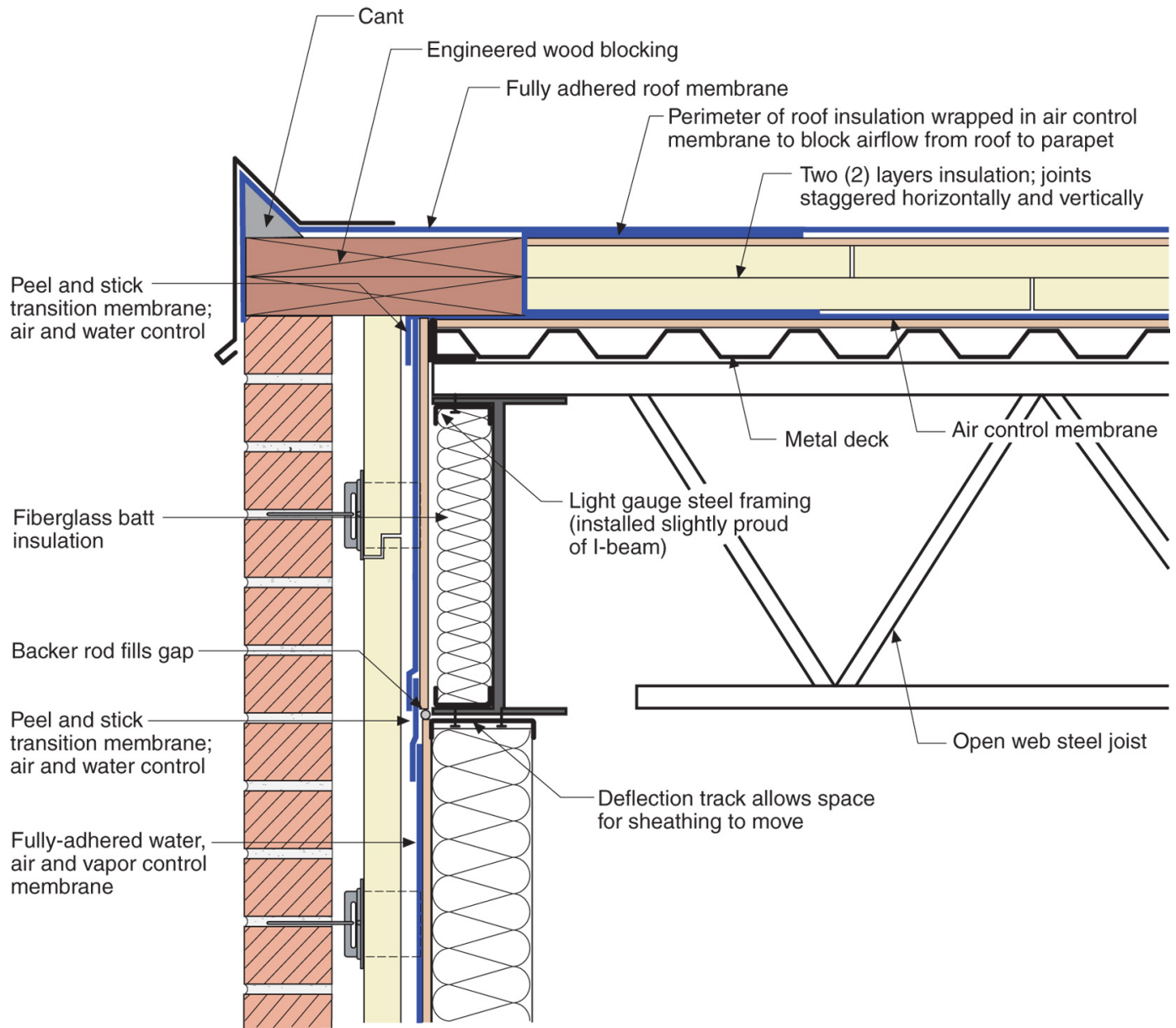

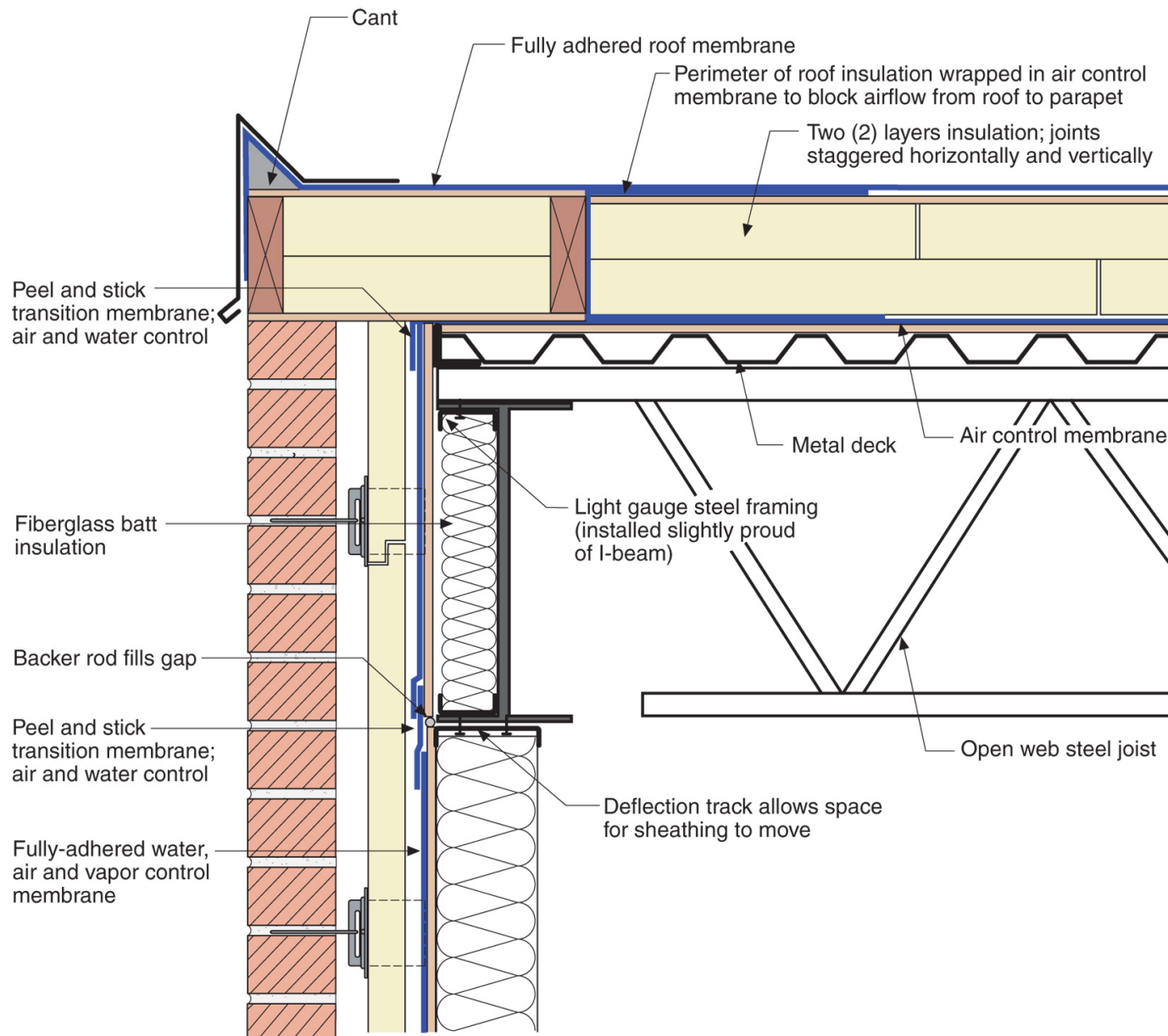

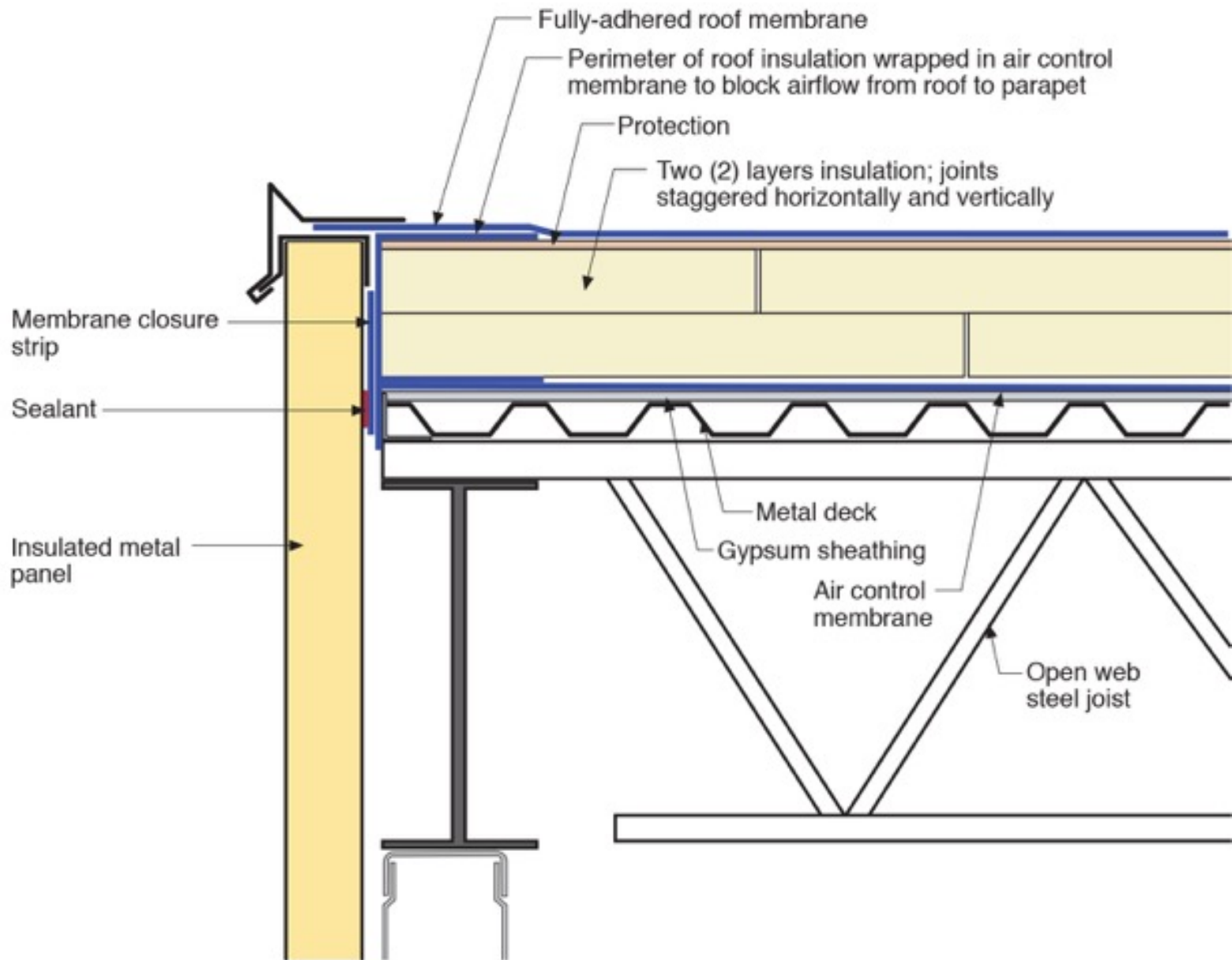

It's a Case of Black or White

It's a Case of Black or White Arrhenius

It's a Case of Black or White

Arrhenius

Every 10 degrees C – double the “badness”

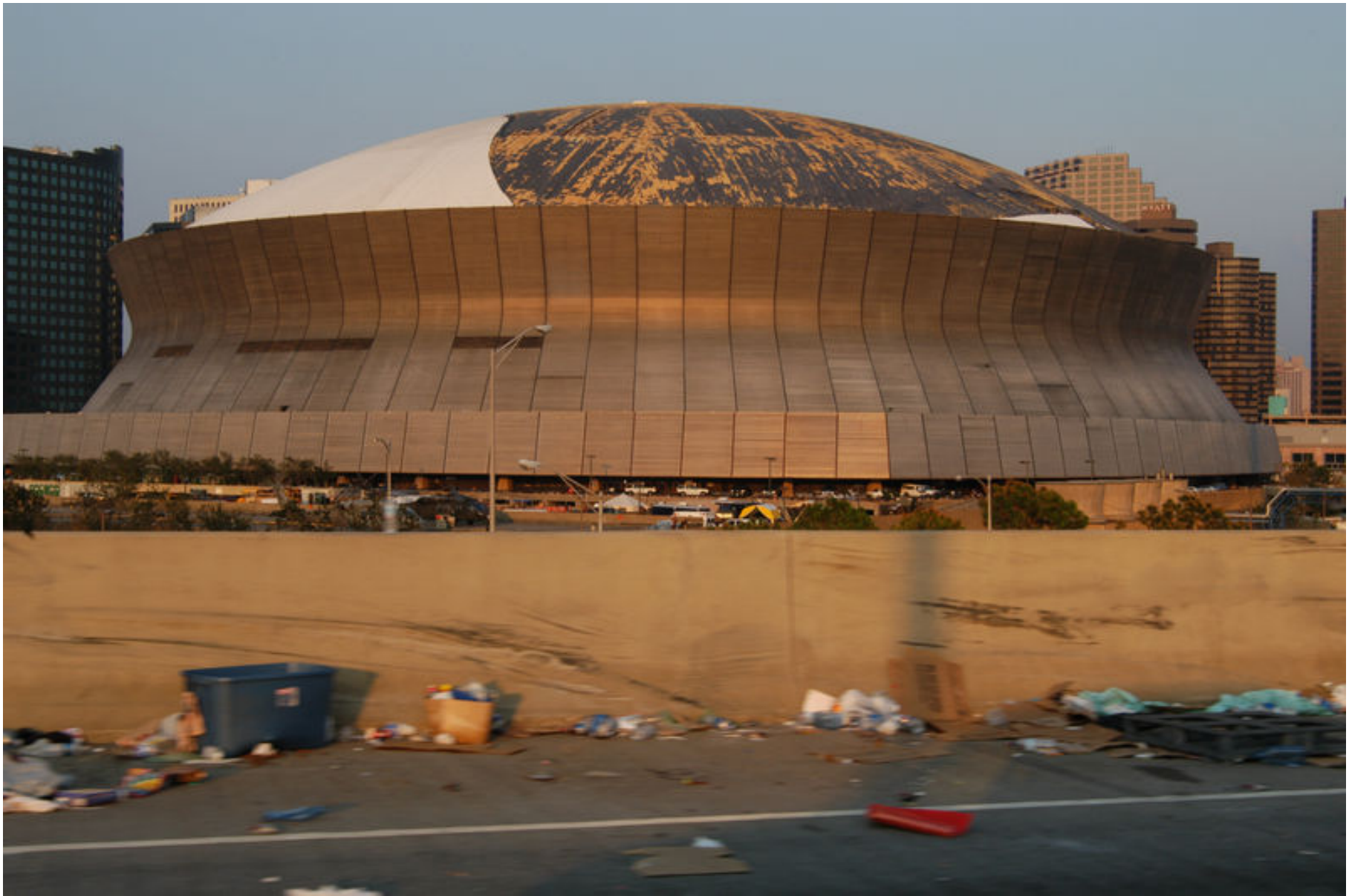

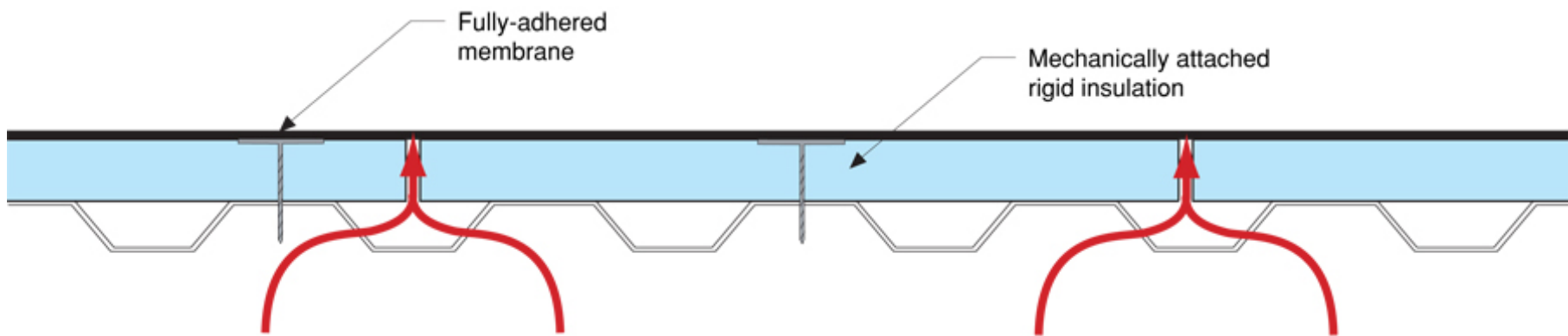



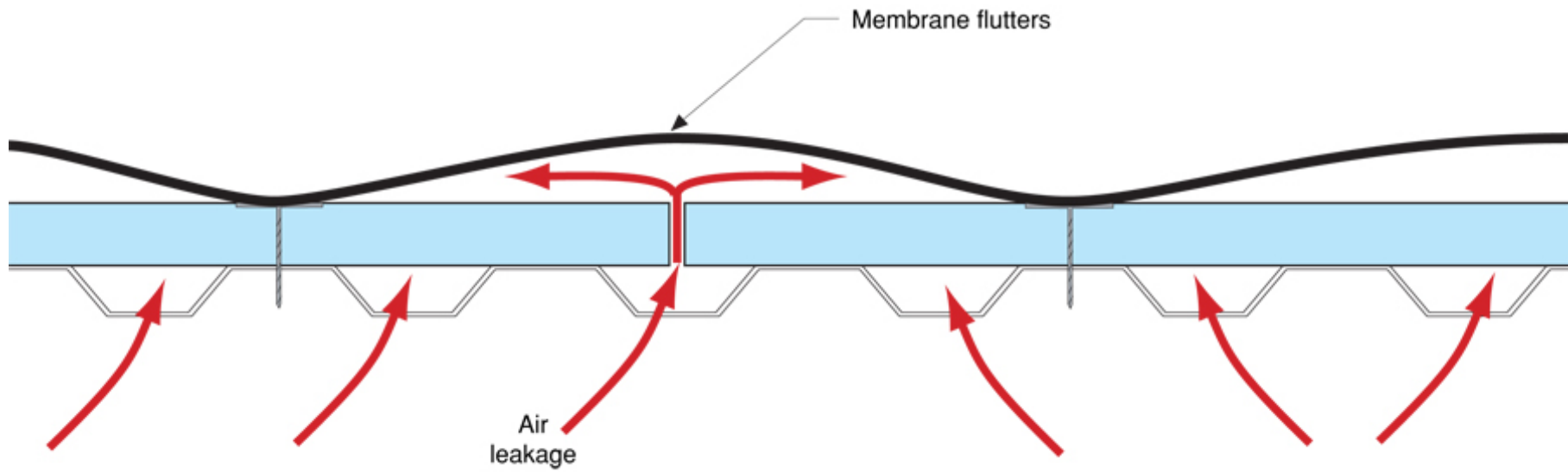





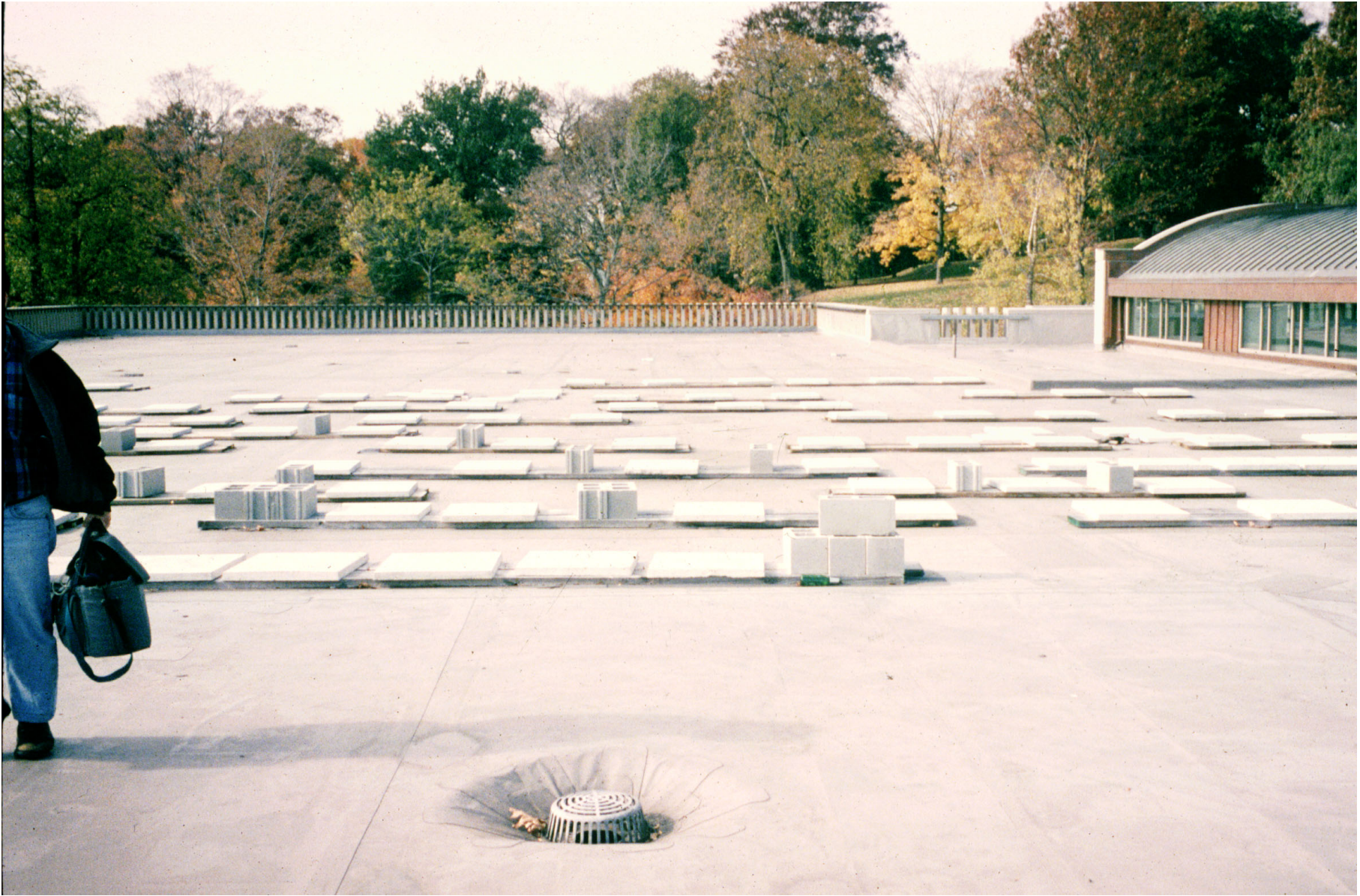



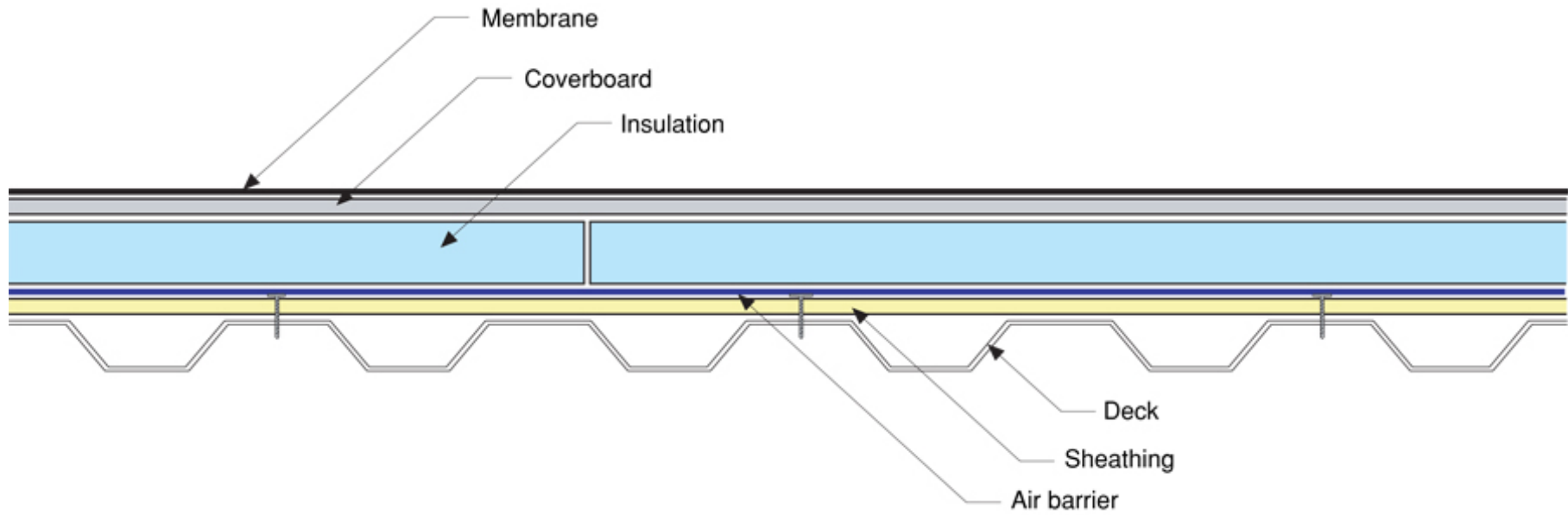

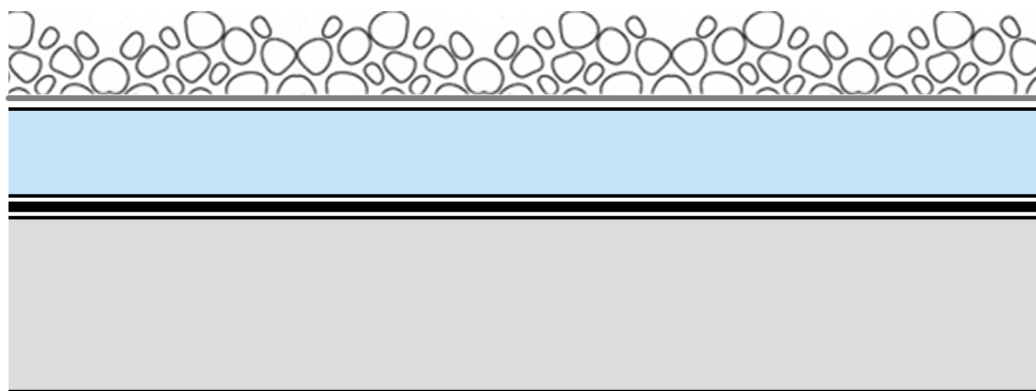

- ← Ballast
- ← Filter fabric
- ← Control layers
- ← Roof structure

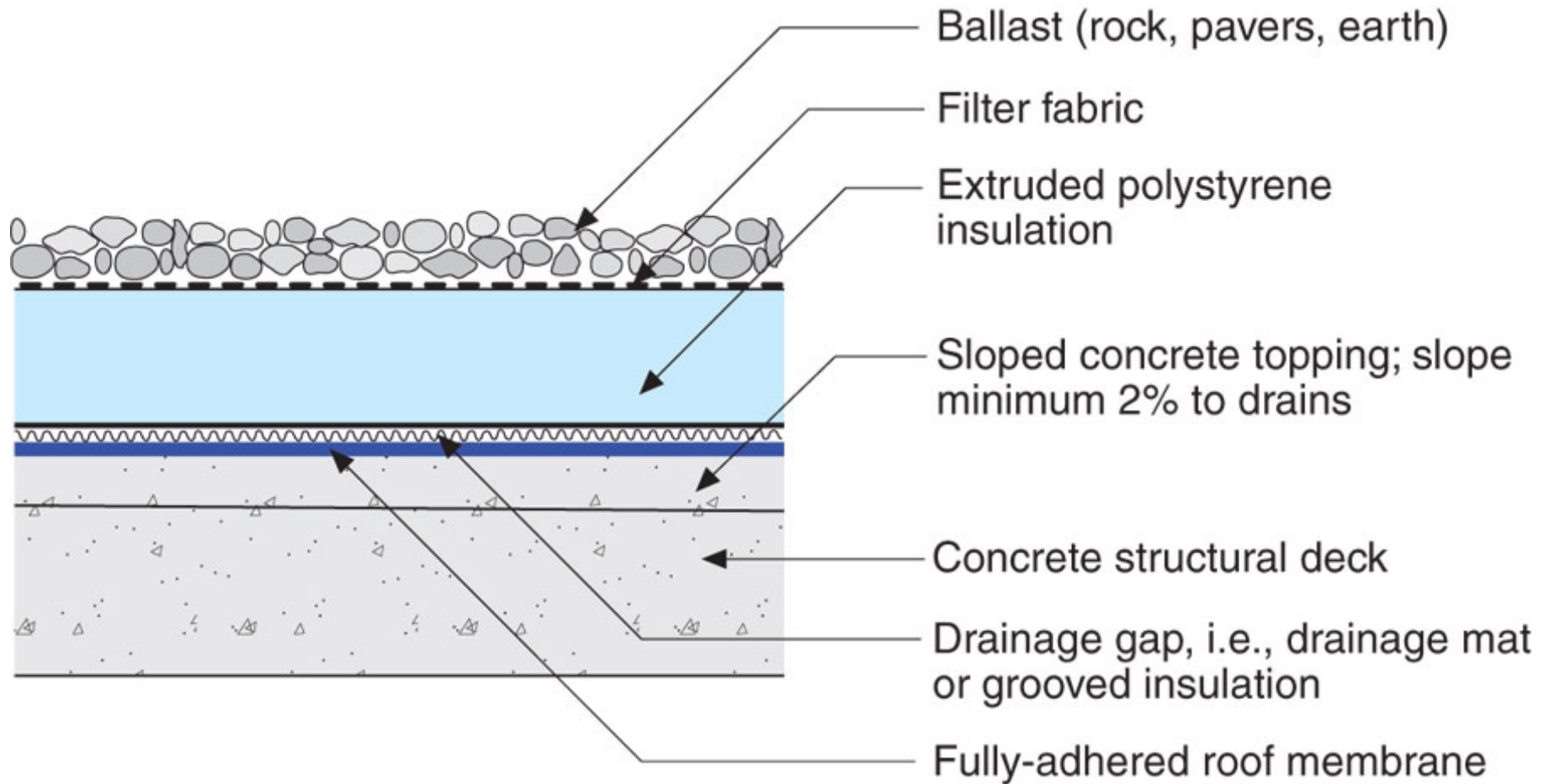

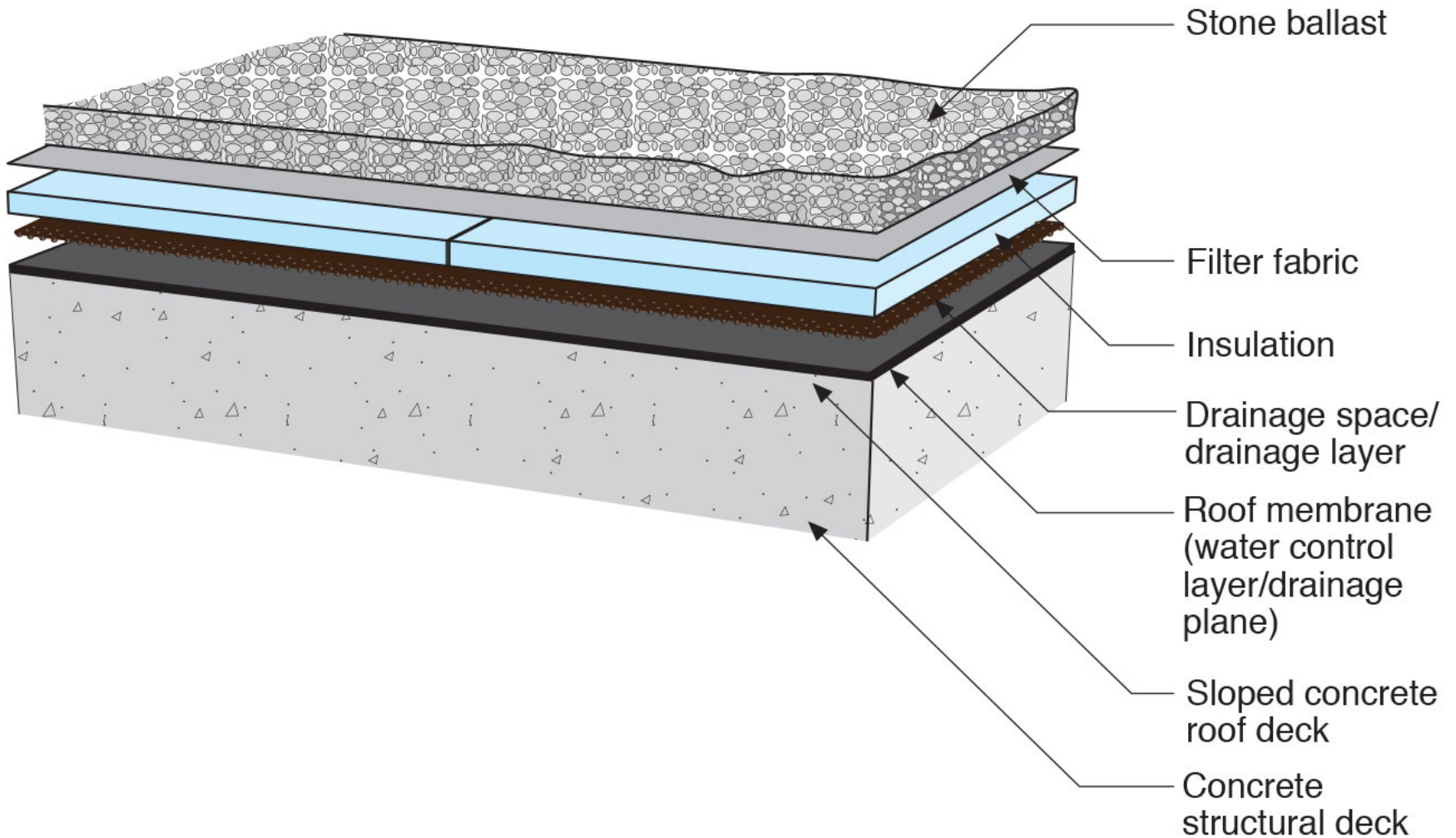

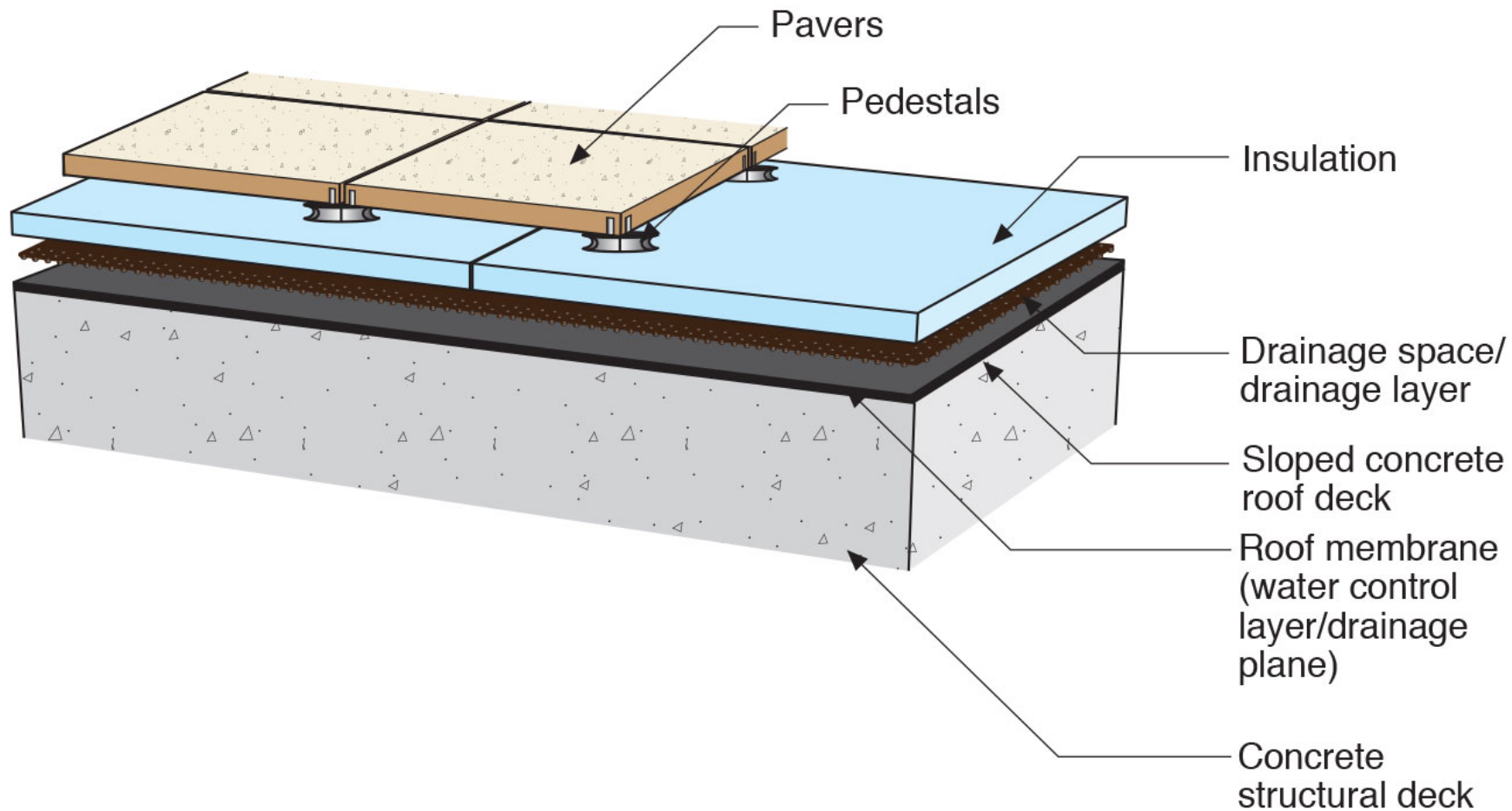

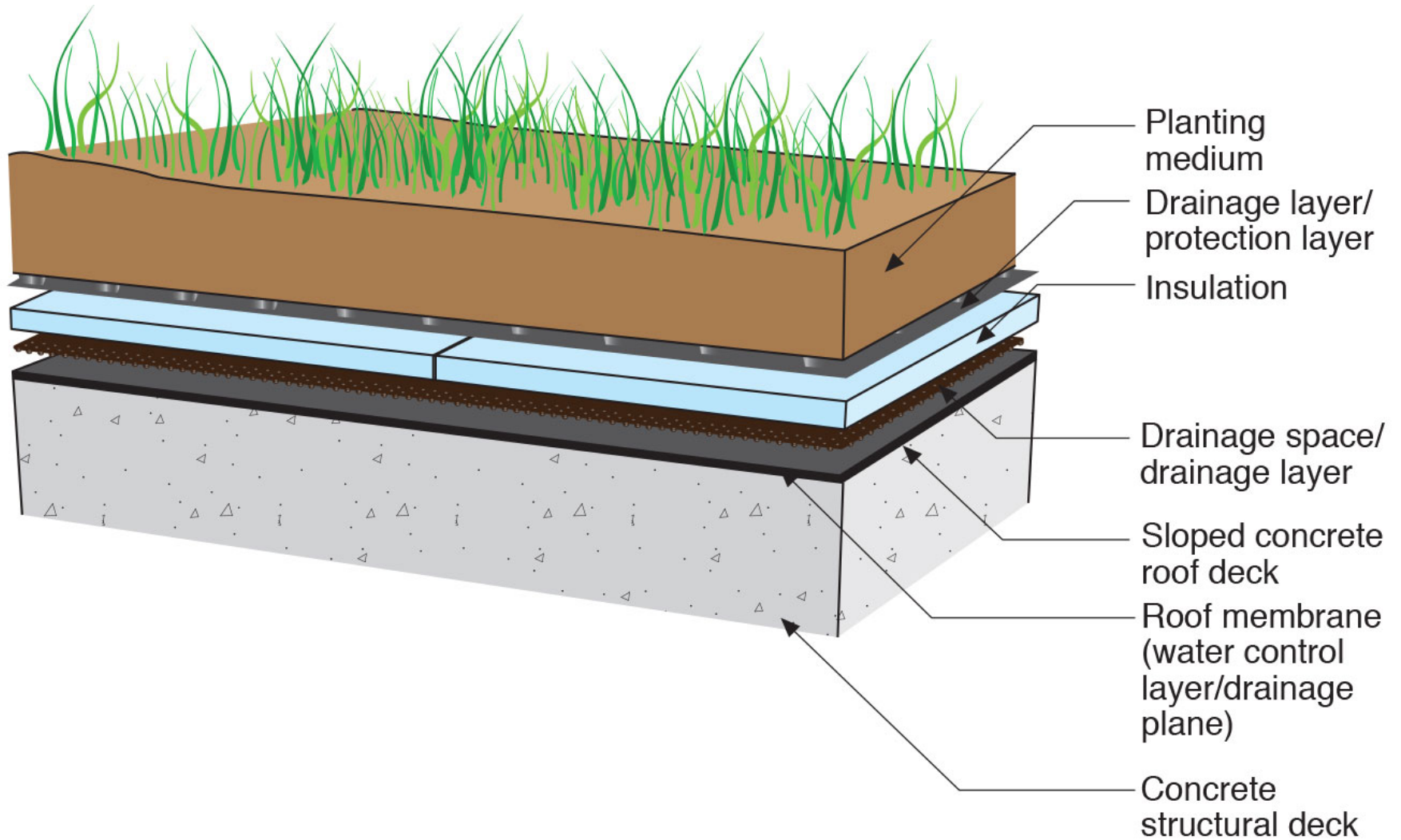

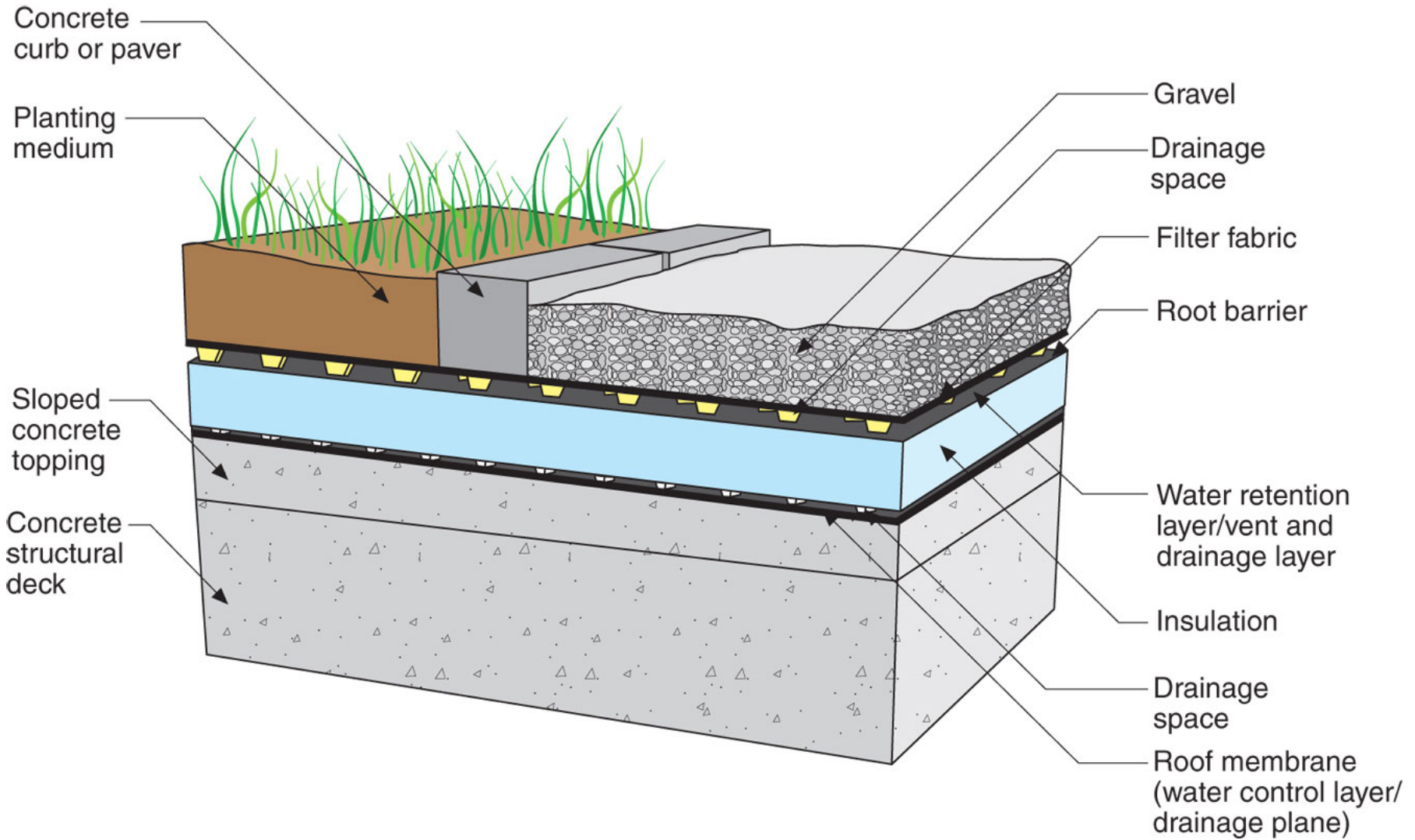













Plaza Decks



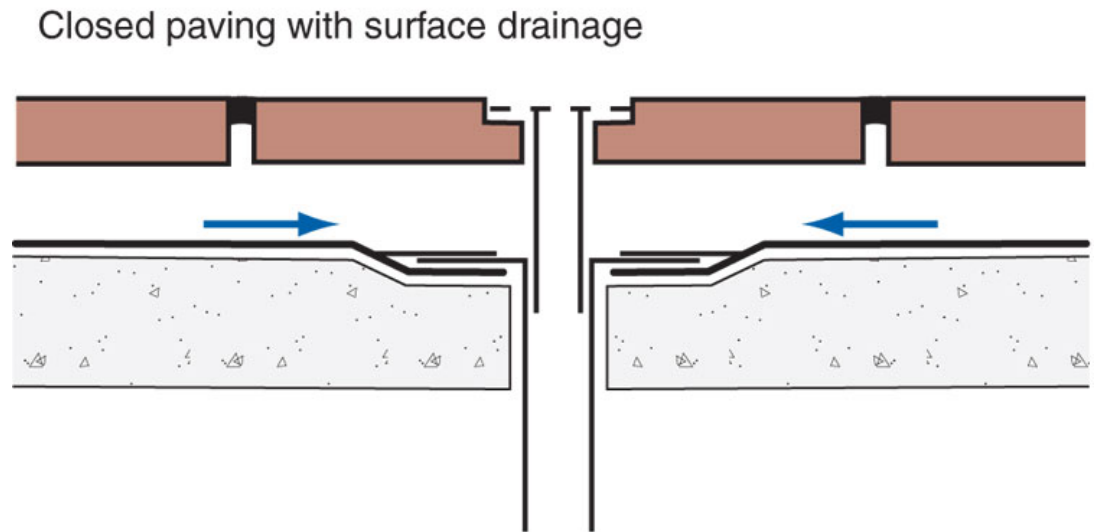
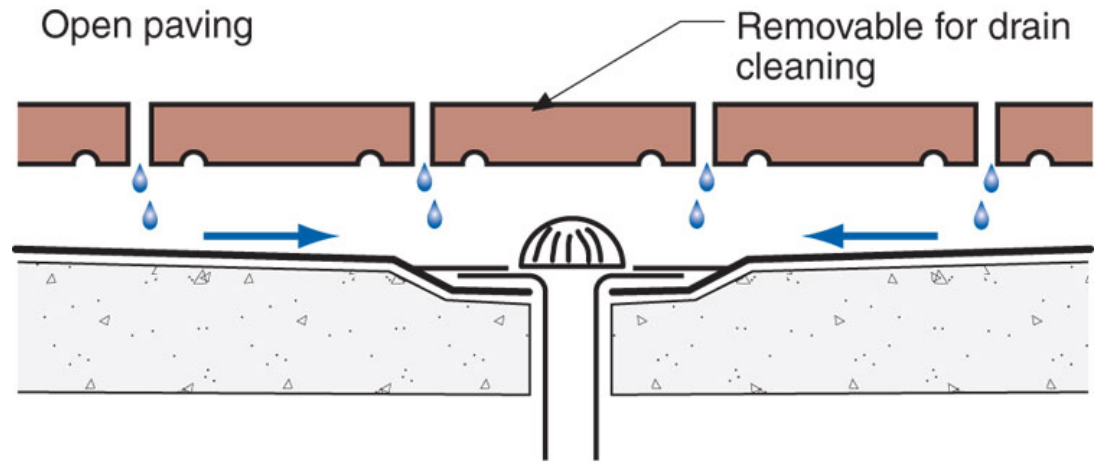

*From Baker, M.; Roofs, 1980
 Courtesy National Research Council of Canada*

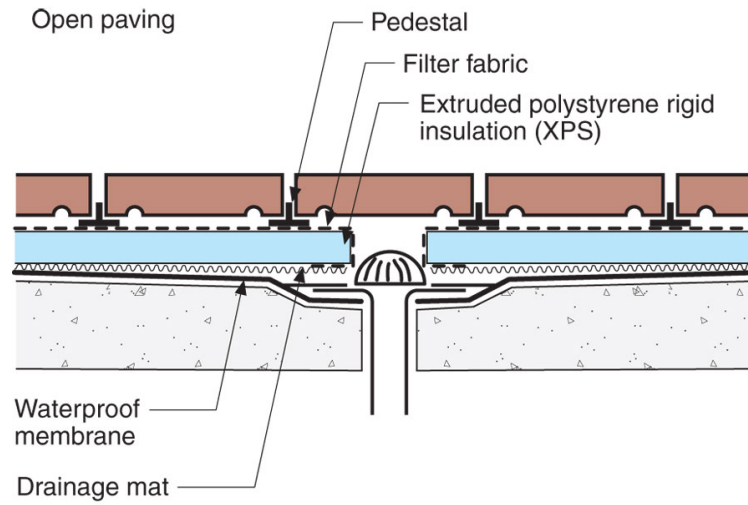

Closed paving with surface drainage

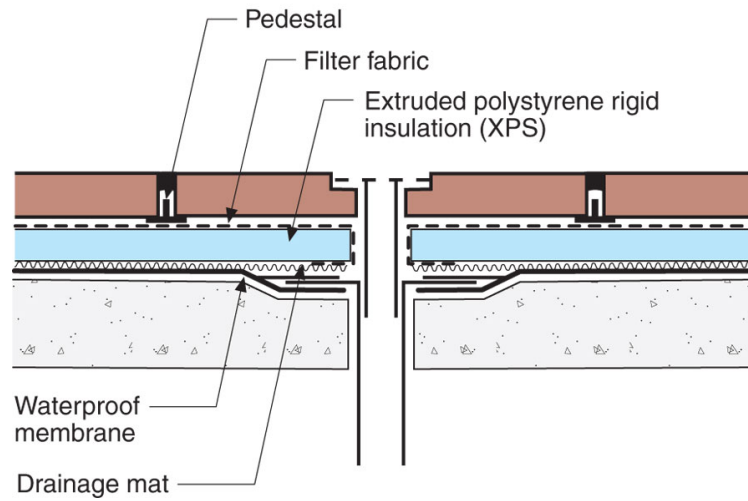





Osmosis

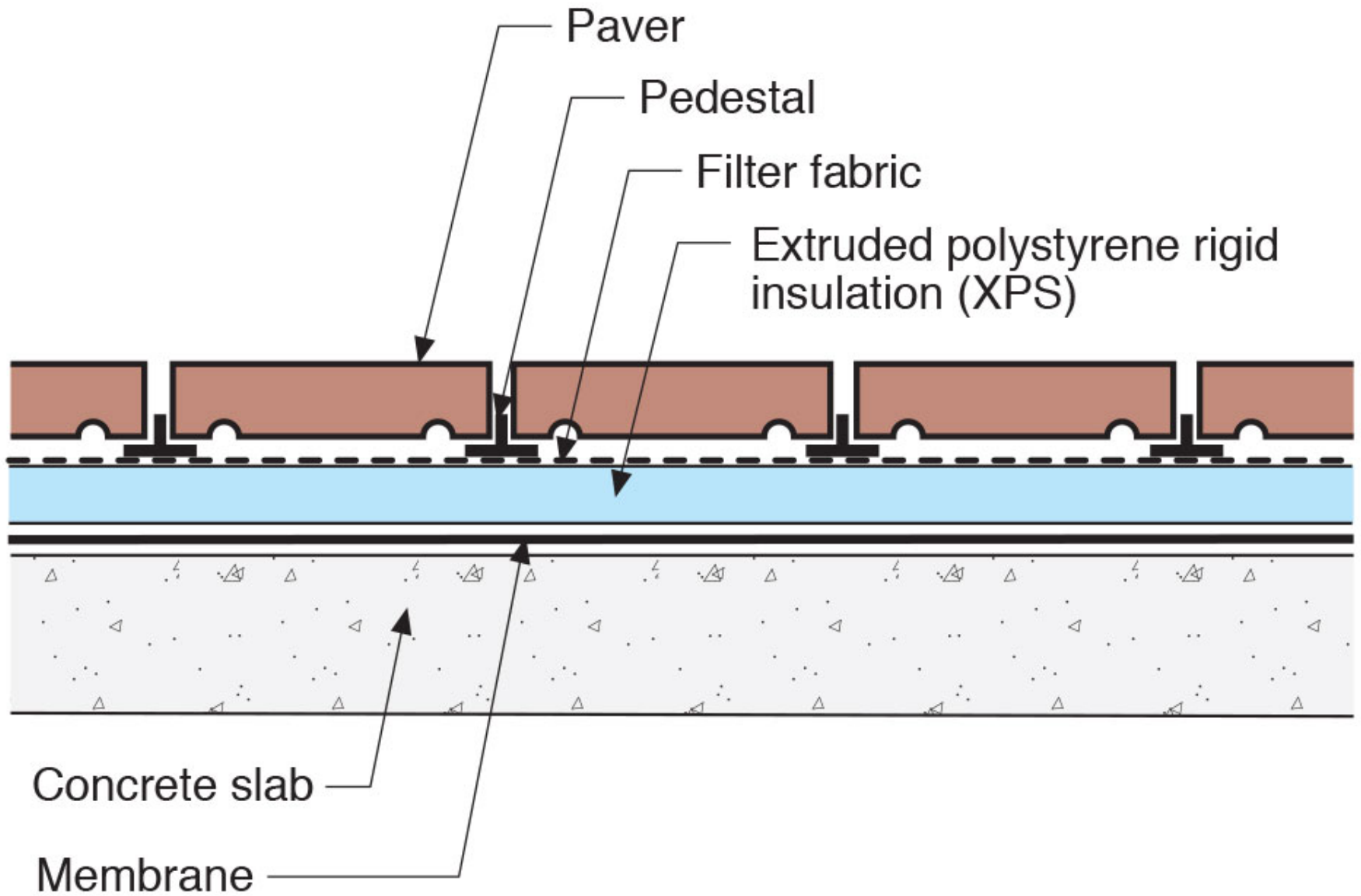

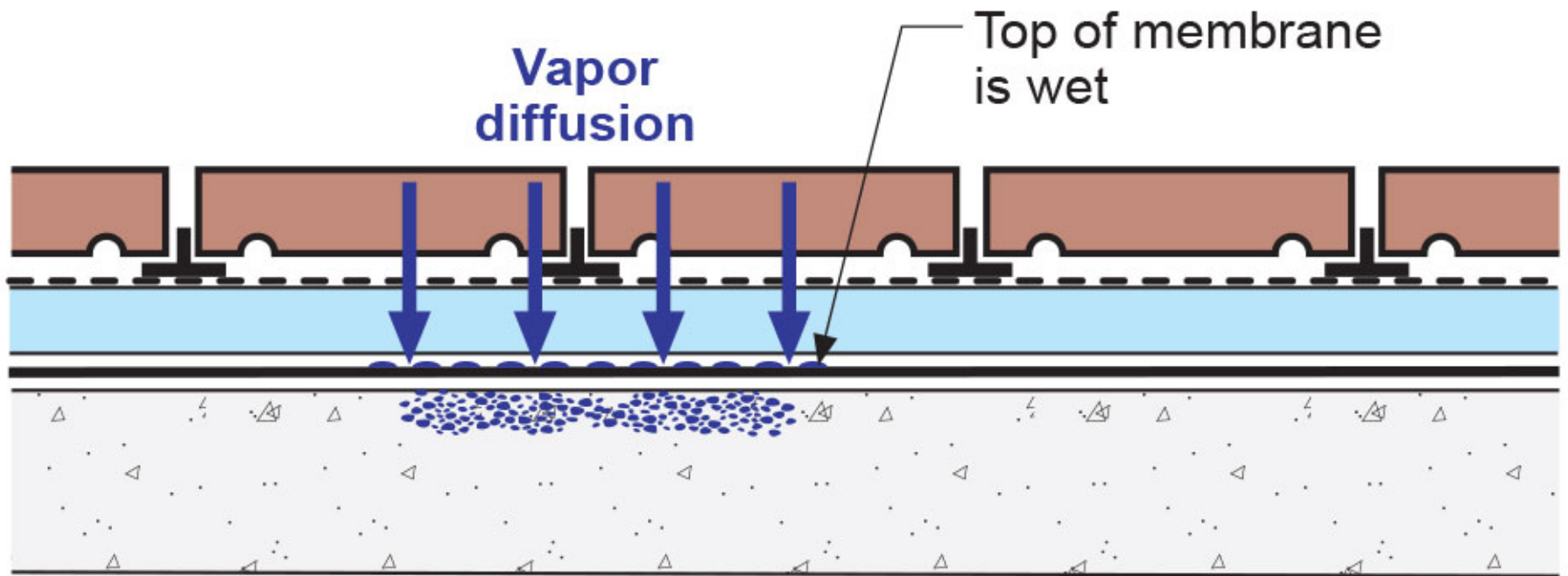

Vapor diffusion

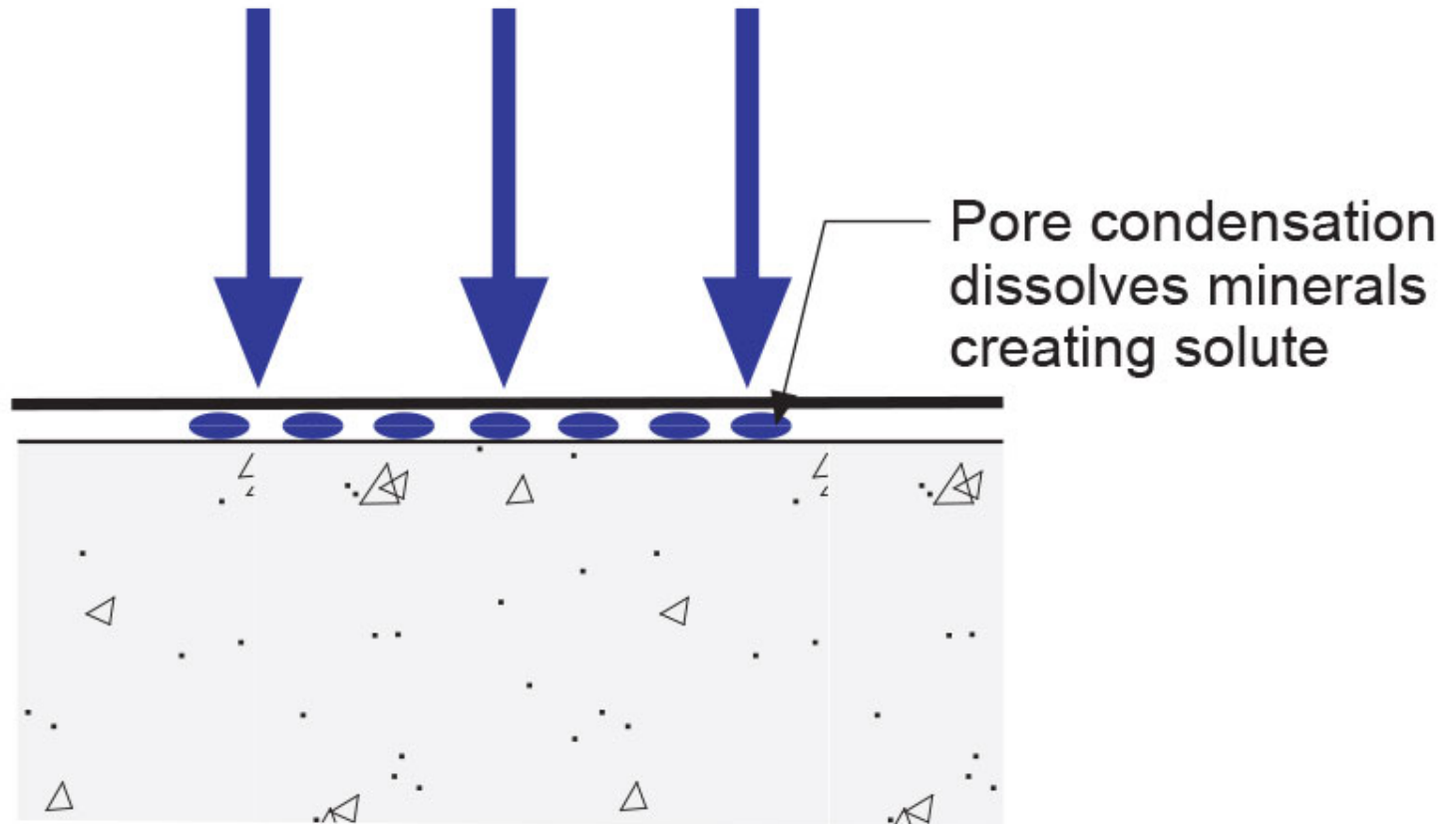

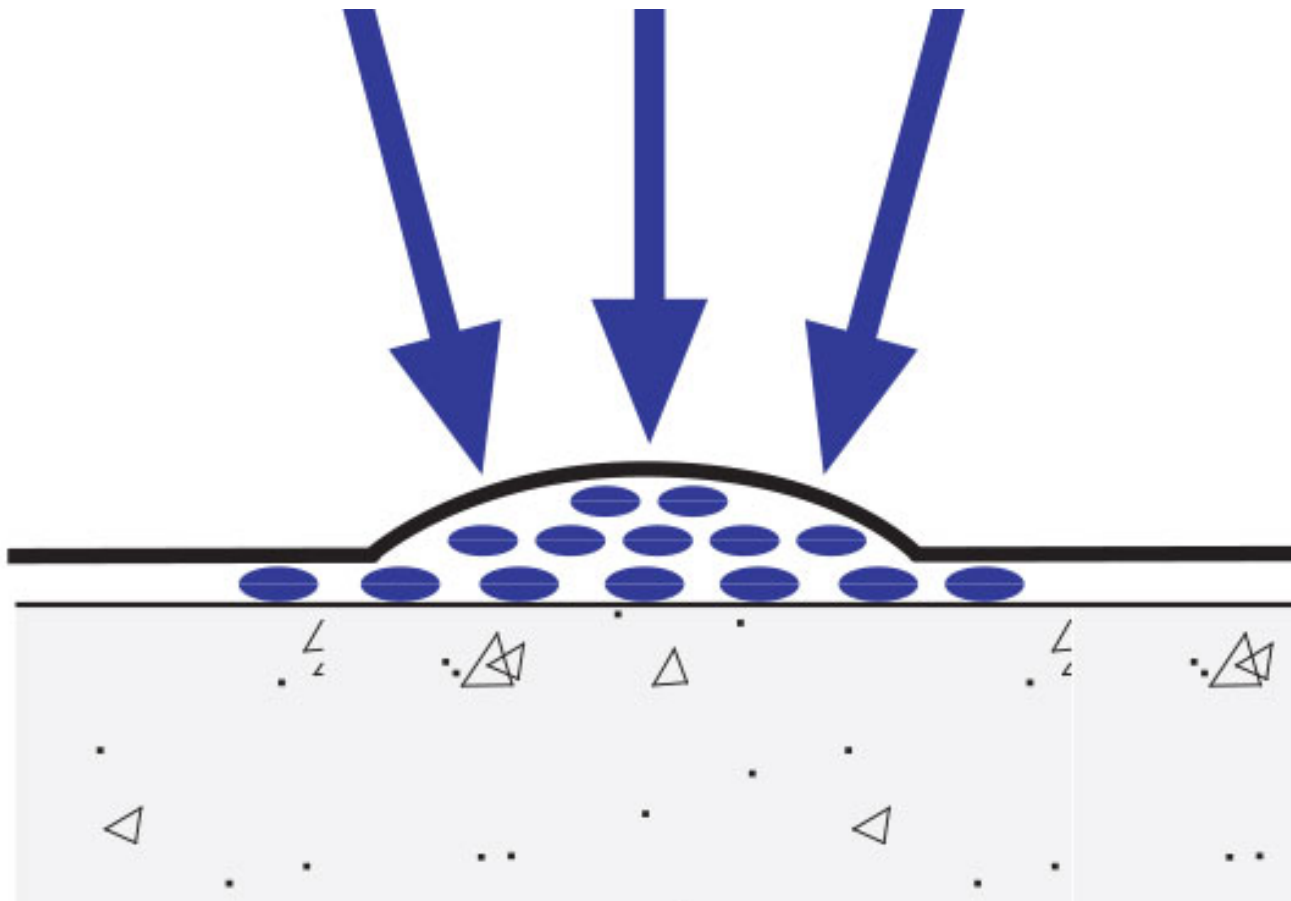



Paver Water Beds!



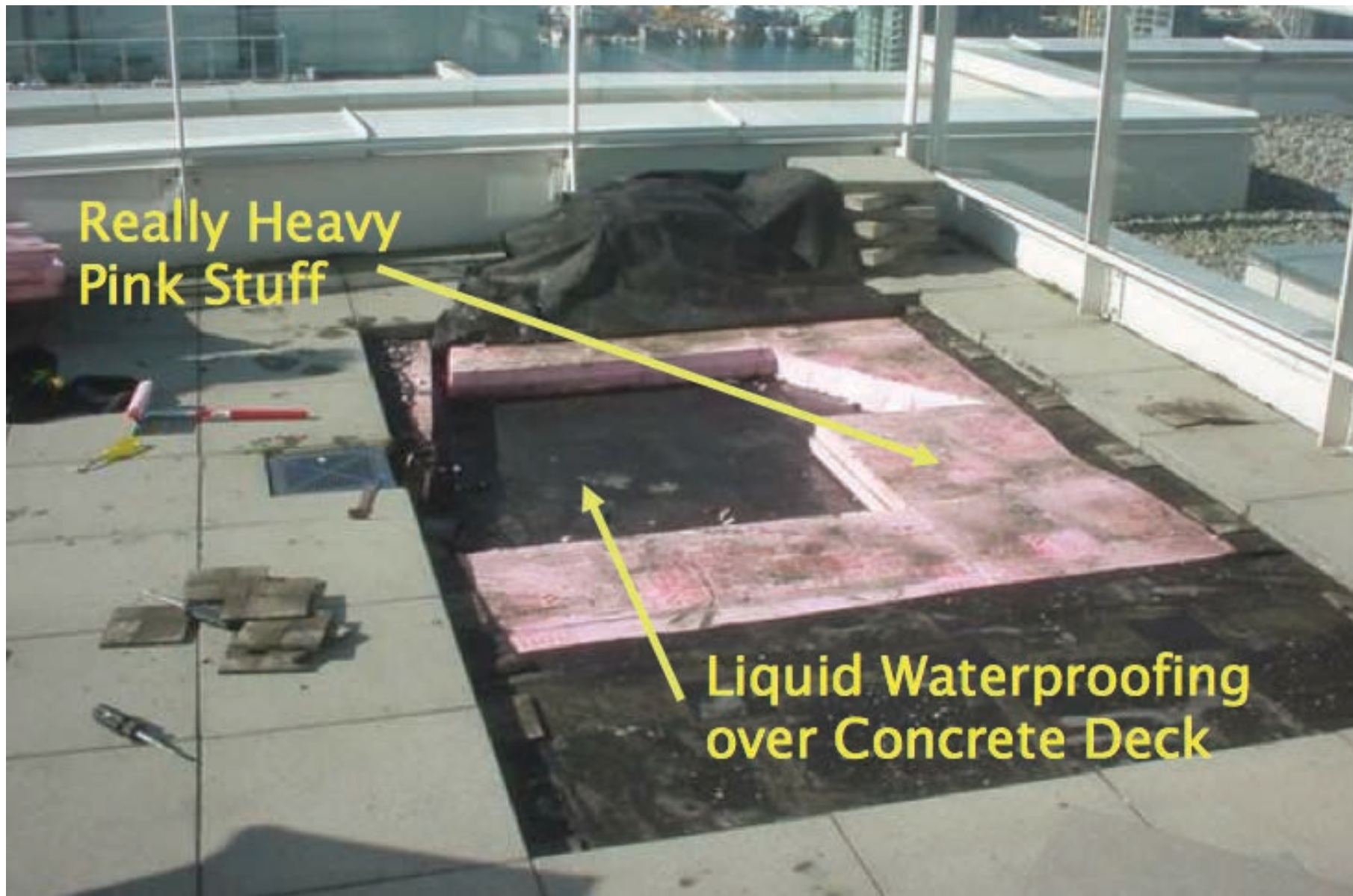

Really Heavy
Pink Stuff

Liquid Waterproofing
over Concrete Deck

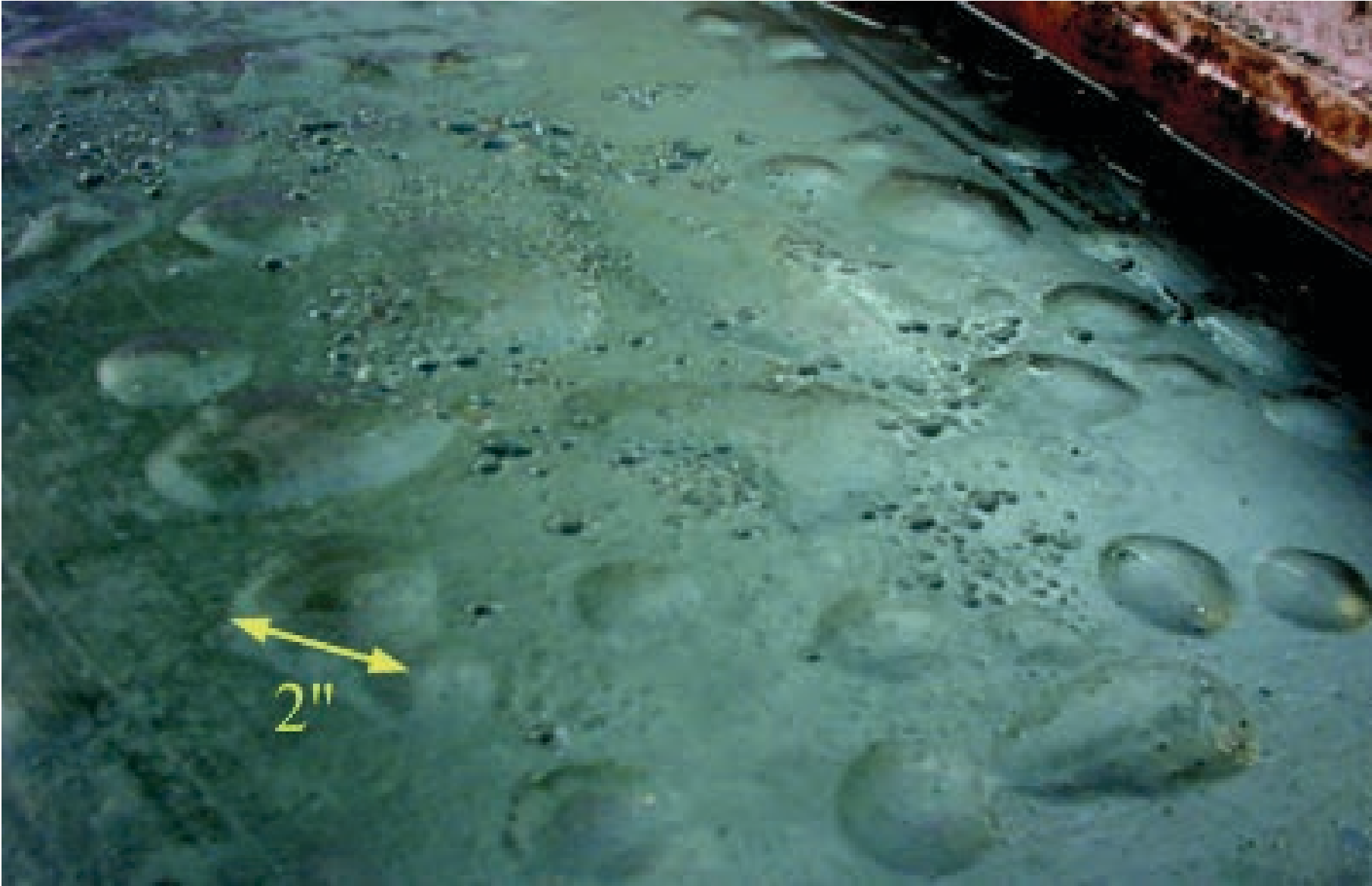



VAPOR PERMEANCE OF LIQUID MEMBRANES

