

Joseph Lstiburek, Ph.D., P.Eng, ASHRAE Fellow

Building Science

Adventures In Building Science

www.buildingscience.com

Arrhenius Equation

Building Science Corporation

Joseph Lstiburek 2

For Every 10 Degree K Rise
Activation Energy Doubles

$$k = Ae^{-E_a/(RT)}$$

Damage Functions

Damage Functions
Water
Heat
Ultra Violet Radiation

Damage Functions
Water
Heat
Ultra Violet Radiation
Oxidization (Ozone)
Fatigue (Creep)

The Three Biggest Problems In Buildings Are Water, Water and Water...

Building Science Corporation

Joseph Lstiburek 7

80 Percent of all Construction Problems are Related to Water

Building Science Corporation

Joseph Lstiburek 8

Laws of Thermodynamics

Building Science Corporation

Joseph Lstiburek 9

Zeroth Law – $A=B$ and $B=C$ therefore $A=C$

First Law - Conservation of Energy

Second Law - Entropy

Third Law – Absolute Zero

Building Science Corporation

Joseph Lstiburek 10

2nd Law of Thermodynamics

Building Science Corporation

Joseph Lstiburek 11

In an isolated system, a process can occur only if it increases the total entropy of the system

Rudolf Clausius

Building Science Corporation

Joseph Lstiburek 12

Heat Flow Is From Warm To Cold
Moisture Flow Is From Warm To Cold
Moisture Flow Is From More To Less
Air Flow Is From A Higher Pressure to a
Lower Pressure
Gravity Acts Down

Moisture Flow Is From Warm To Cold
Moisture Flow Is From More To Less

Moisture Flow Is From Warm To Cold
Moisture Flow Is From More To Less

Thermal Gradient – Thermal Diffusion
Concentration Gradient – Molecular Diffusion

Moisture Flow Is From Warm To Cold
Moisture Flow Is From More To Less

Thermal Gradient – Thermal Diffusion
Concentration Gradient – Molecular Diffusion

Vapor Diffusion

Thermodynamic Potential

Building Science Corporation

Joseph Lstiburek 17

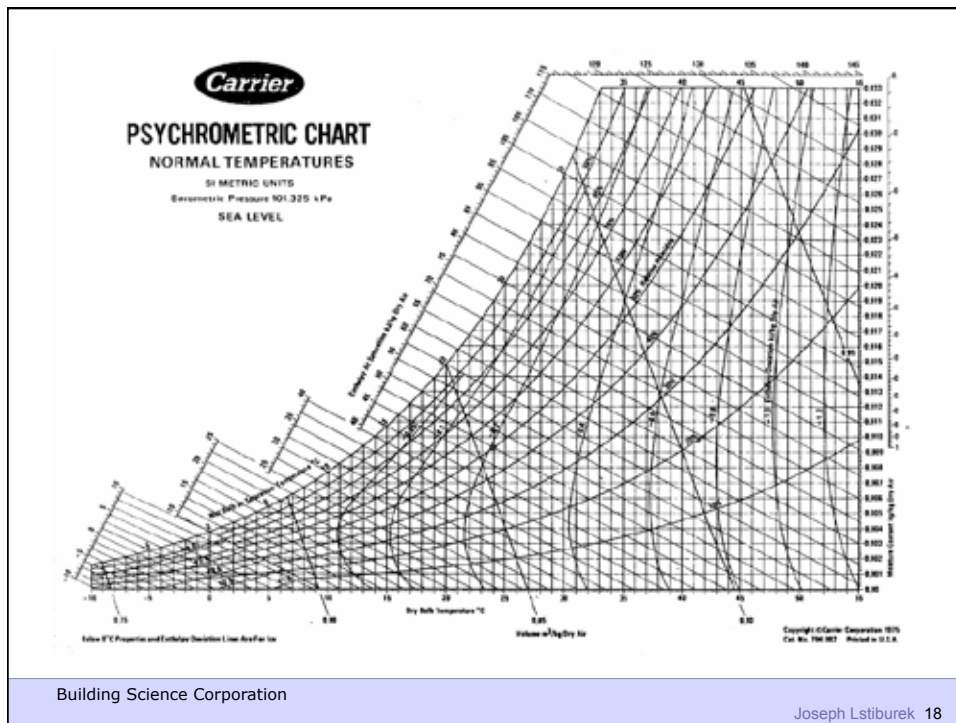

Building Science Corporation

Joseph Lstiburek 18

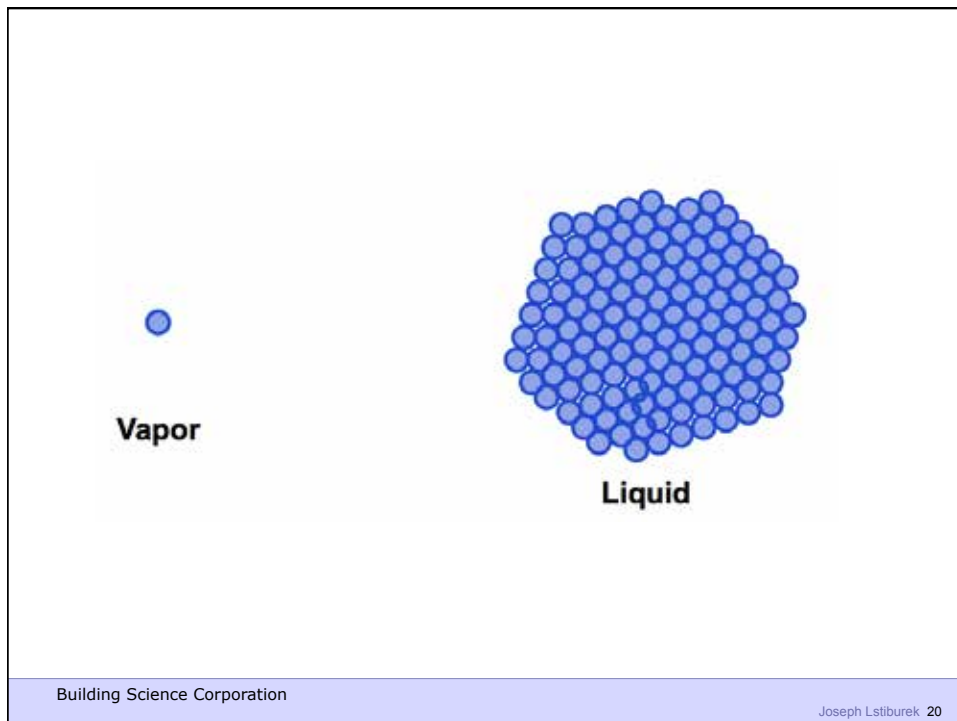
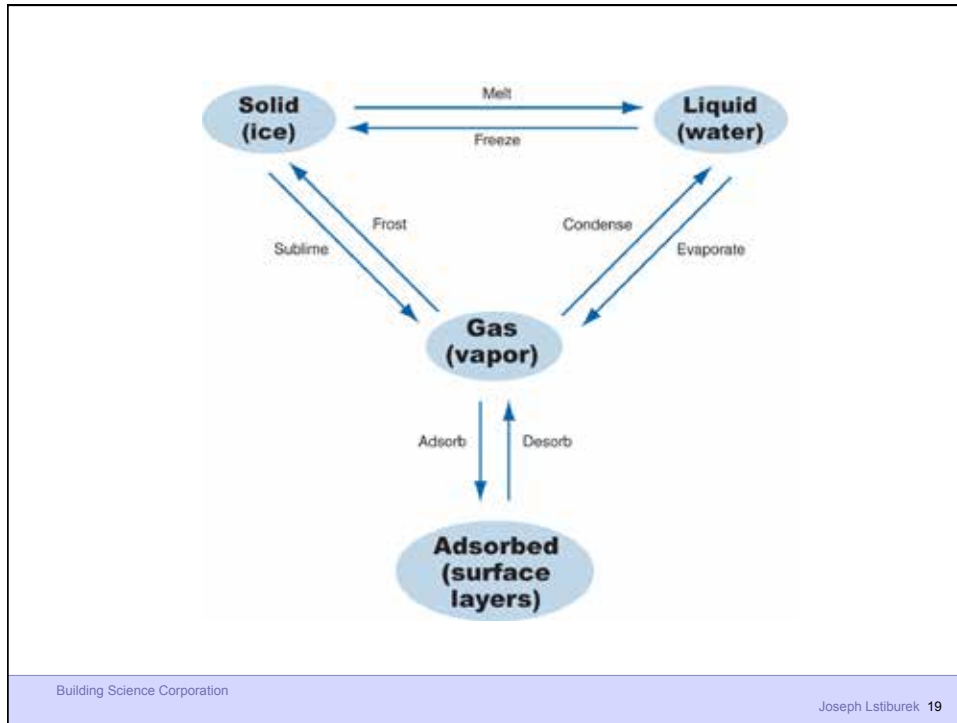

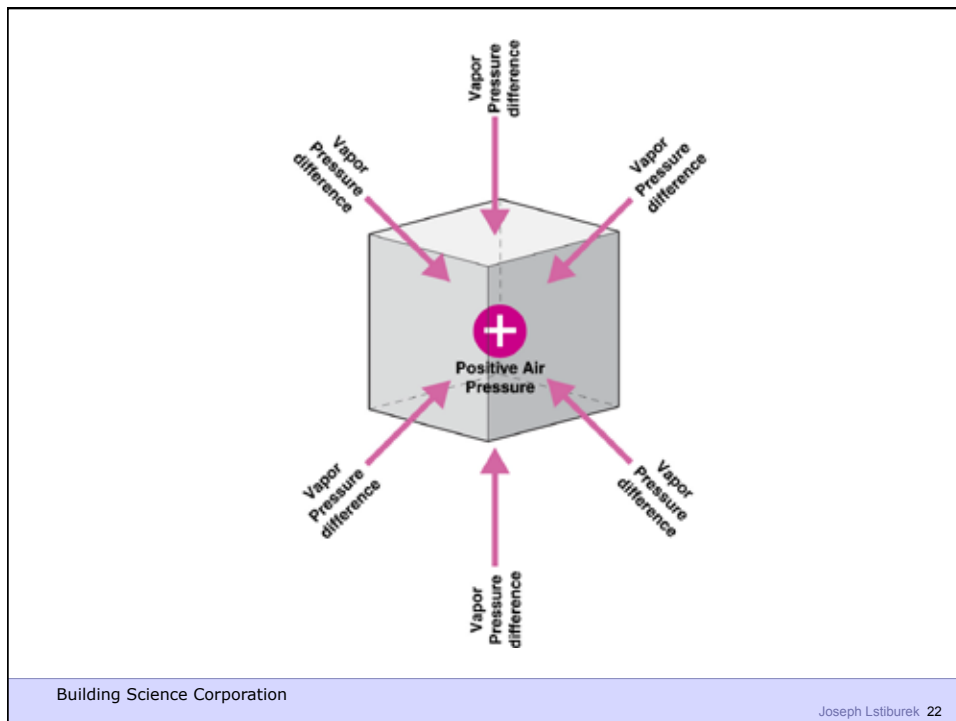
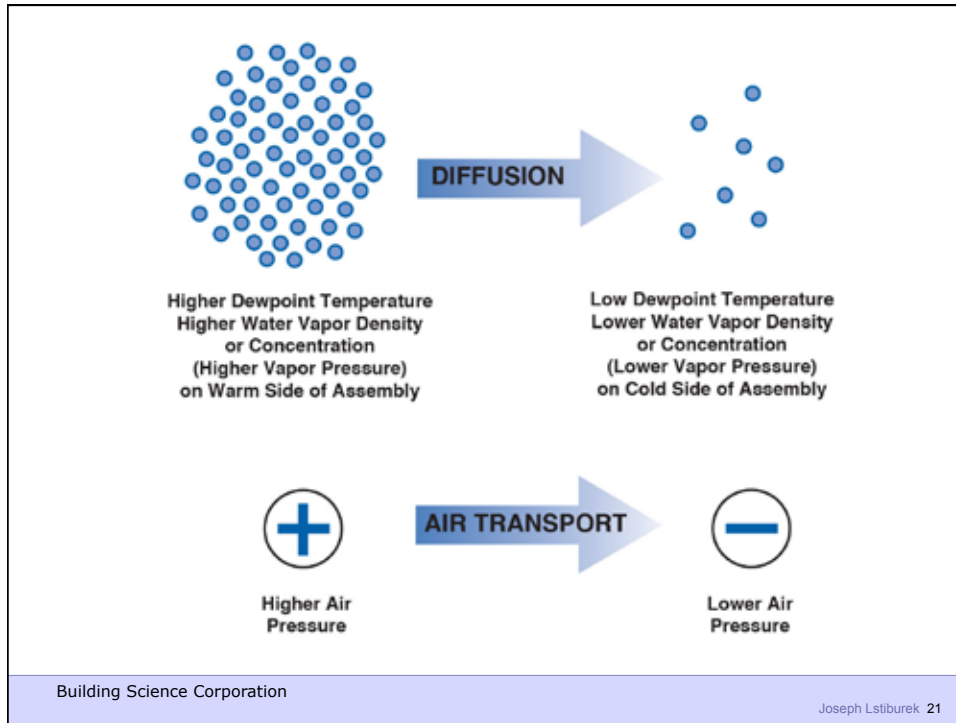

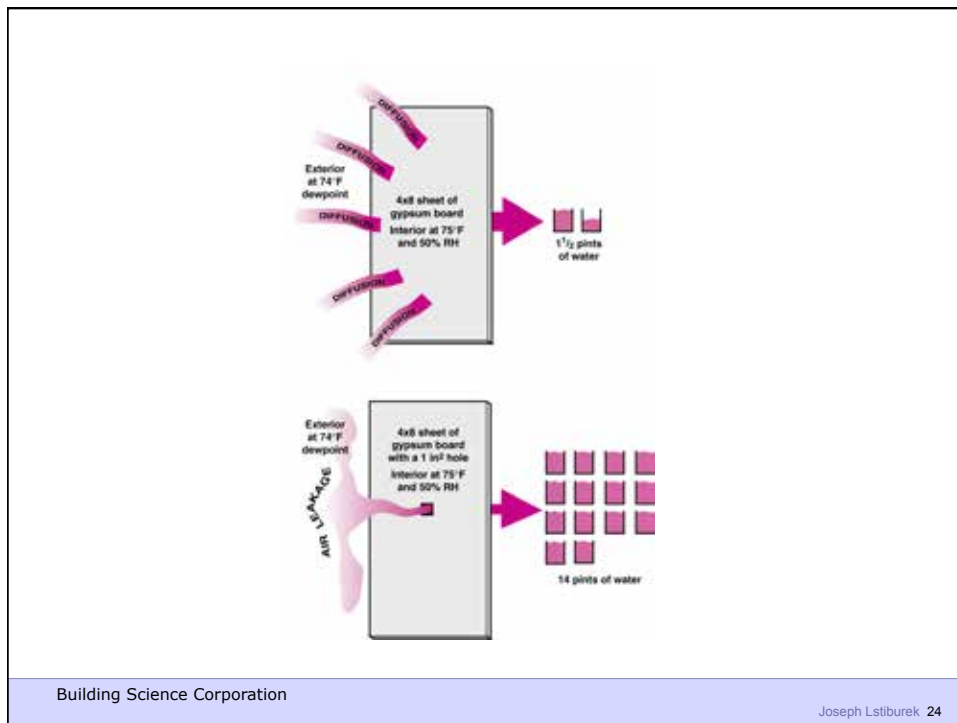
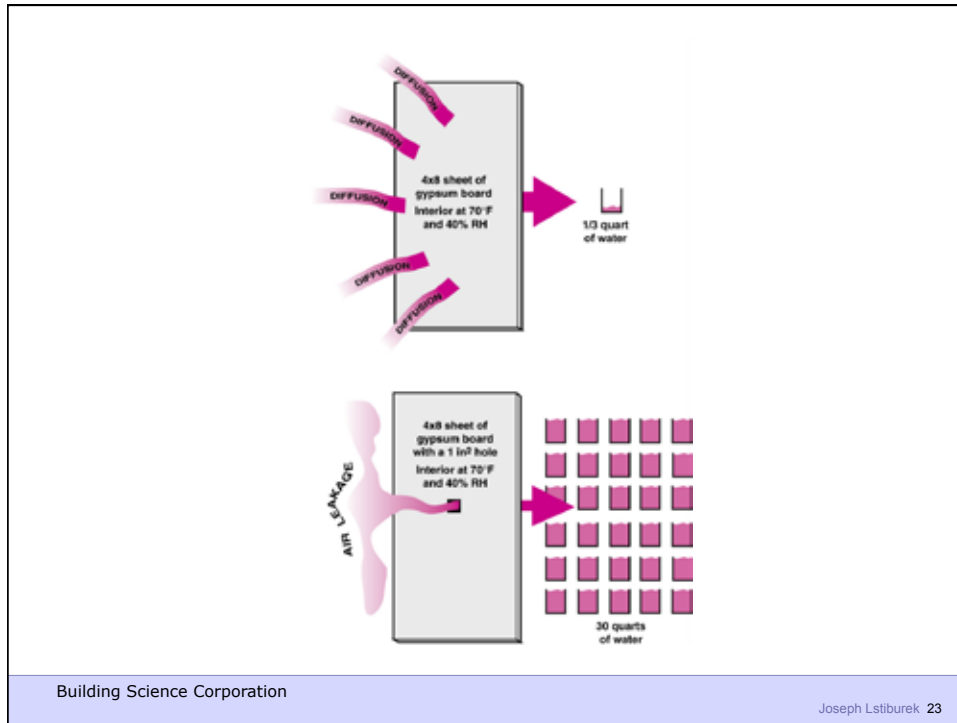

Vapor Pressure and Relative Humidity

Building Science Corporation

Joseph Lstiburek 25

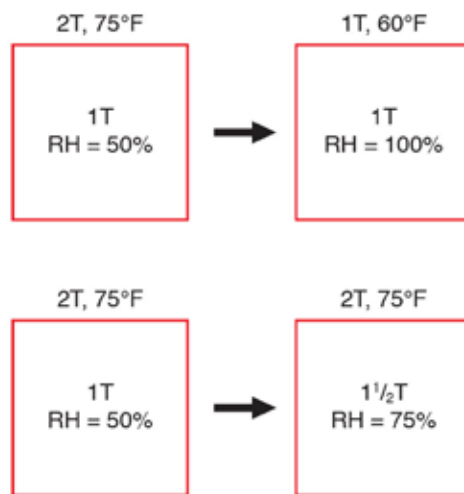

Building Science Corporation

Joseph Lstiburek 26

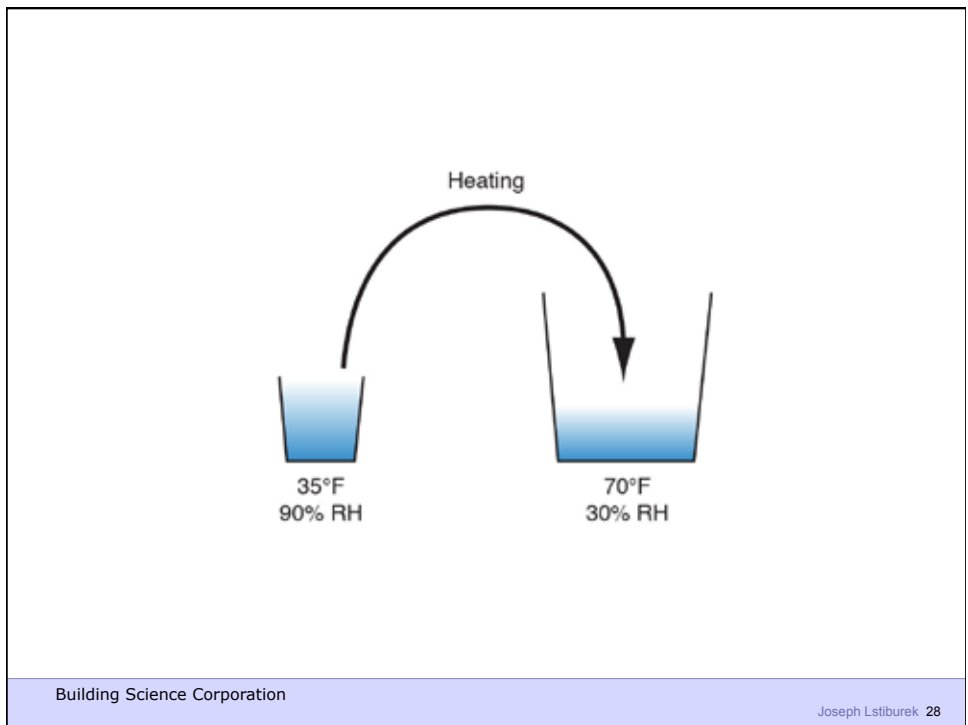
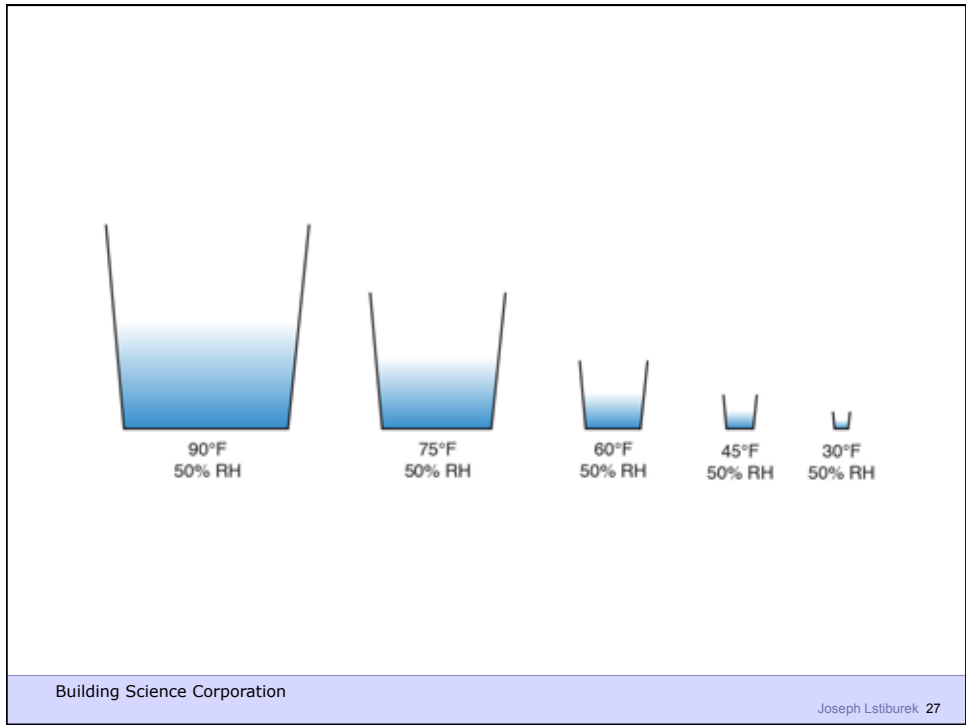

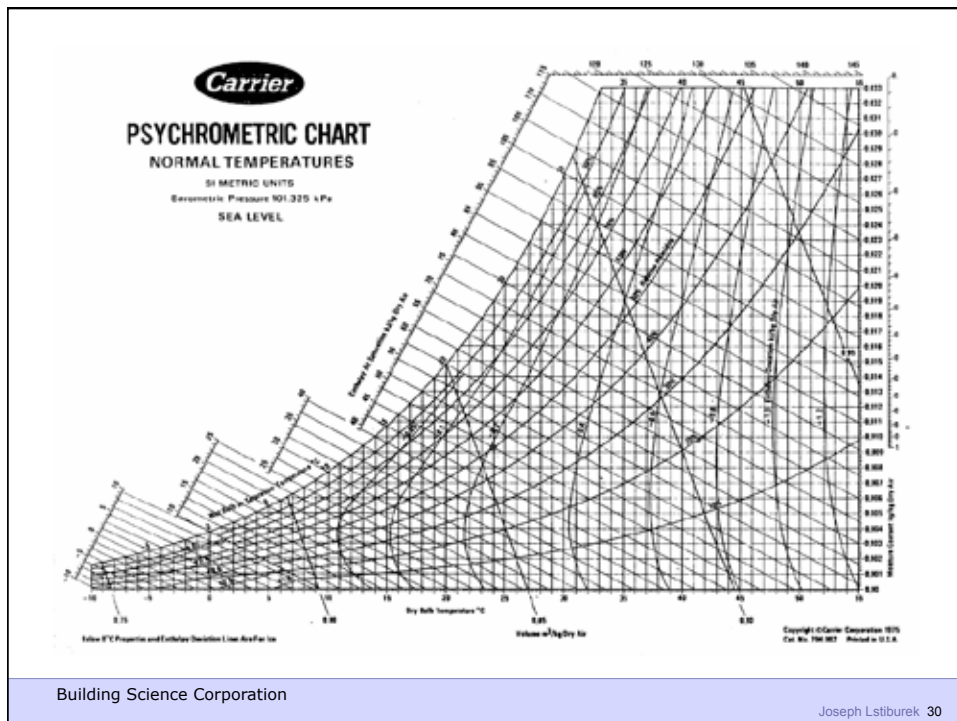
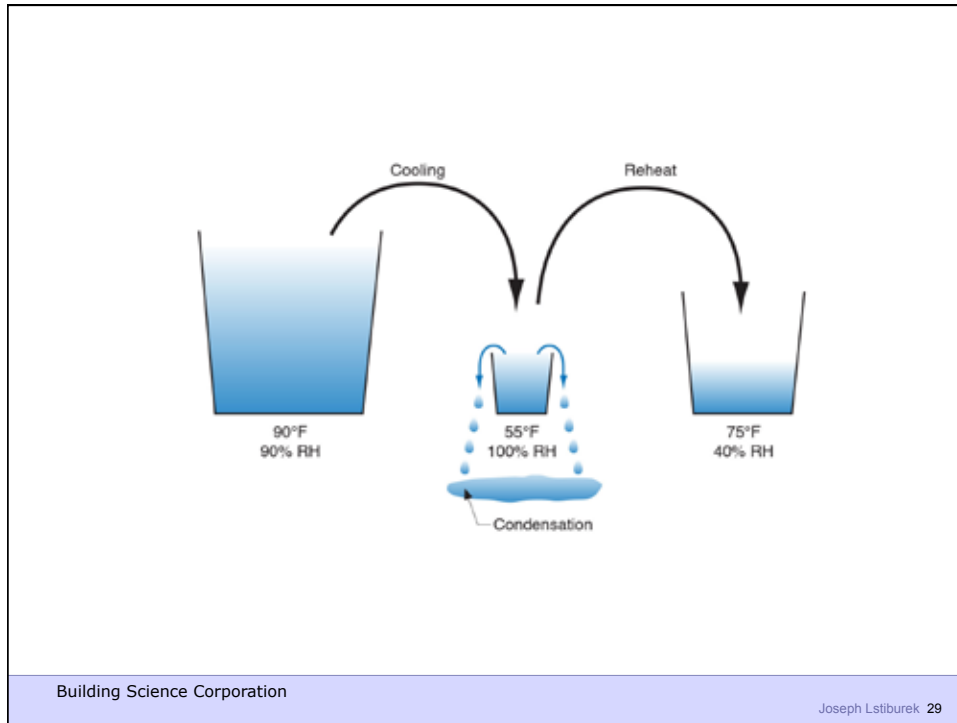

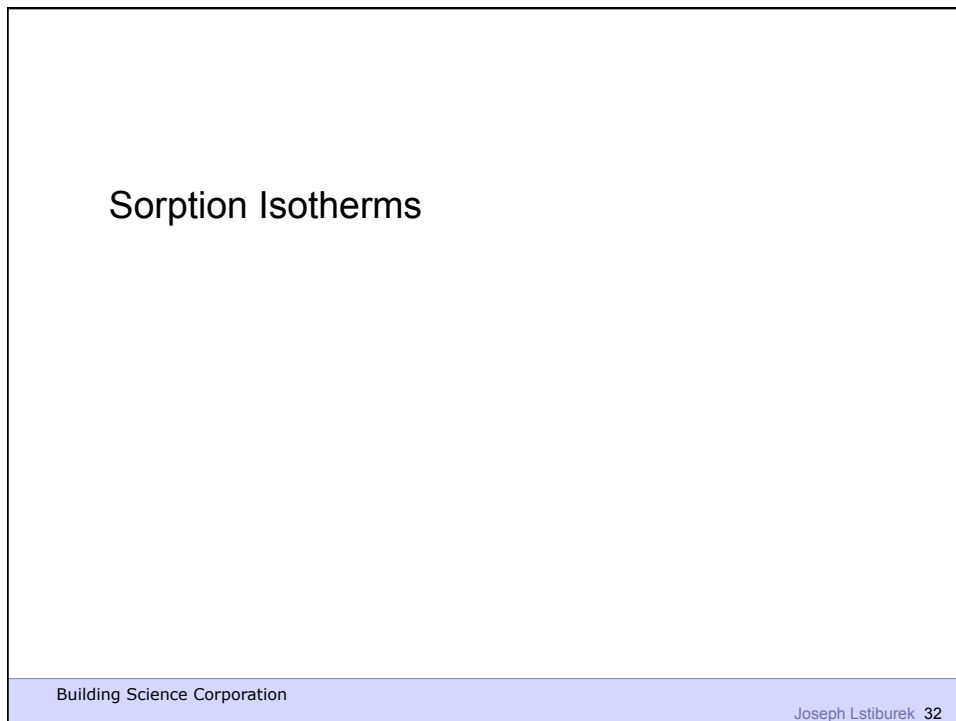
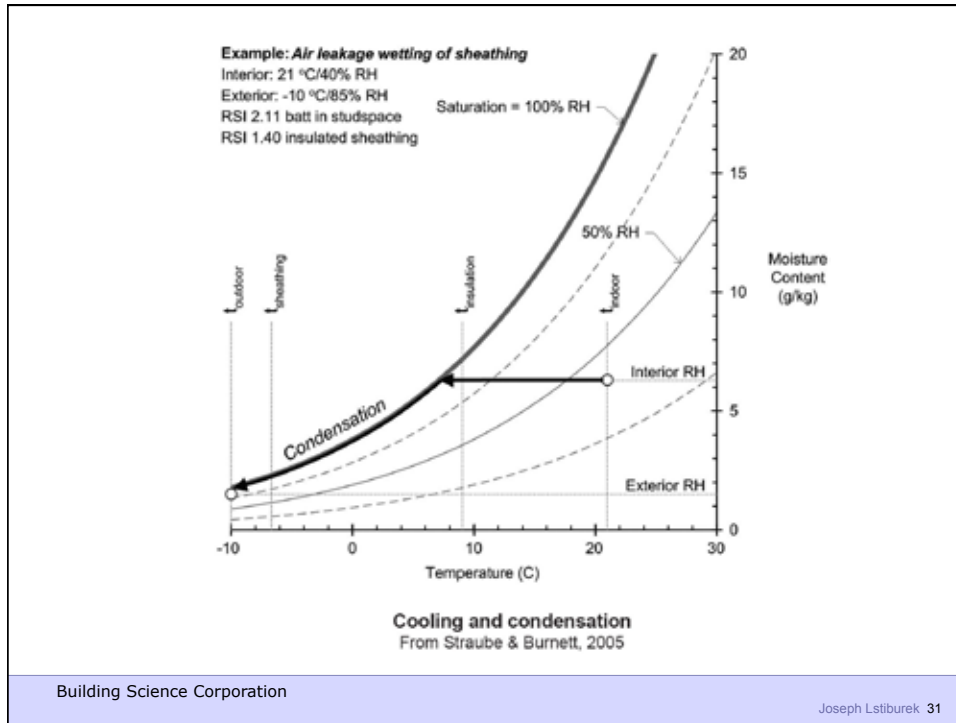

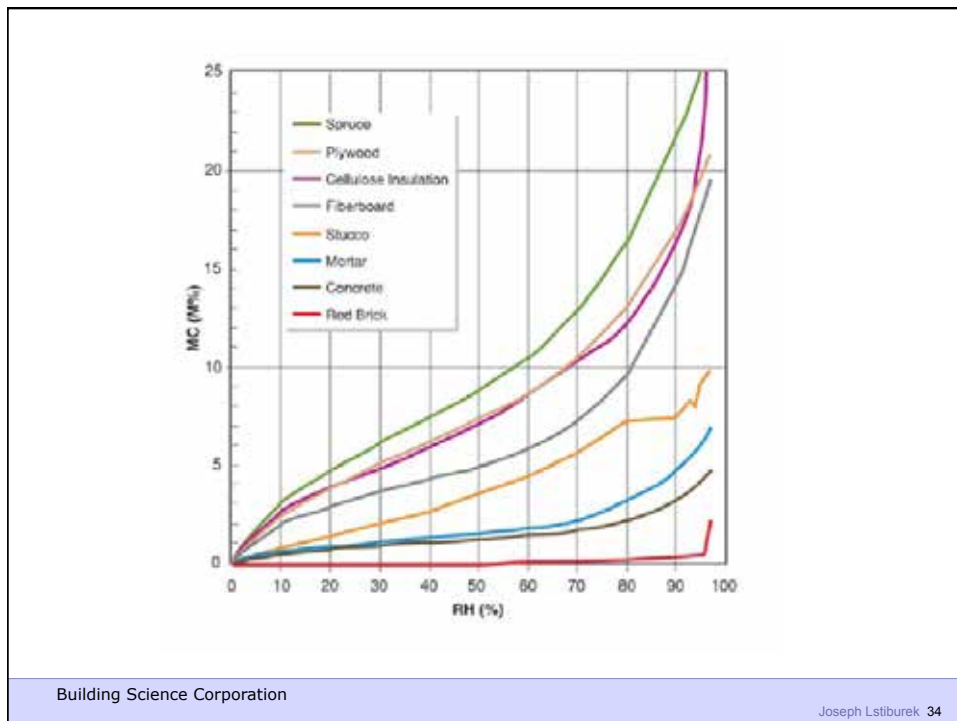
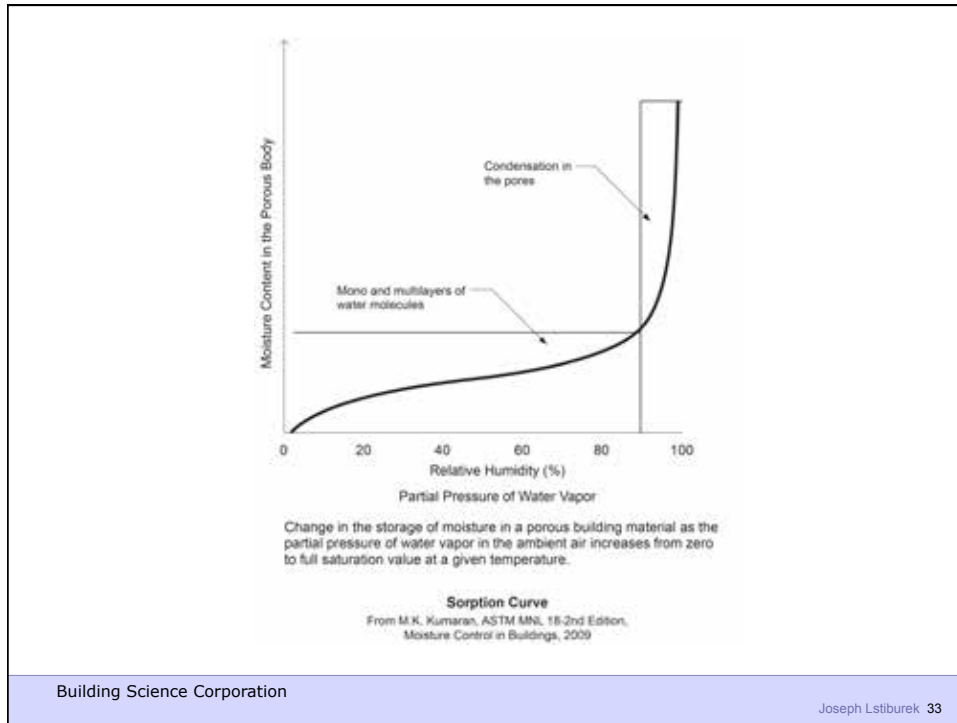

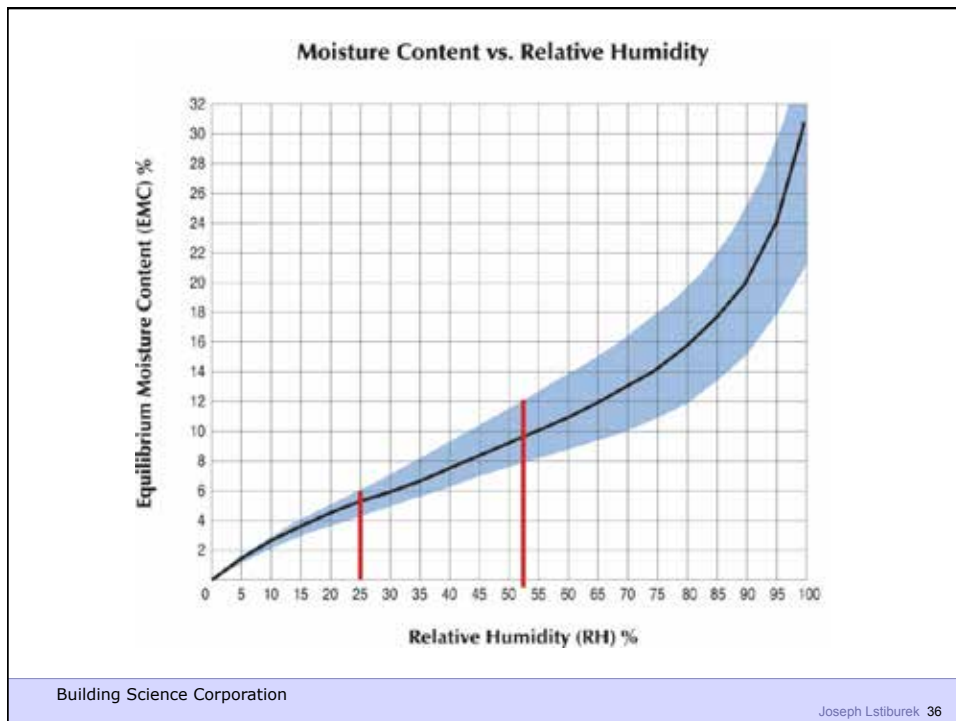
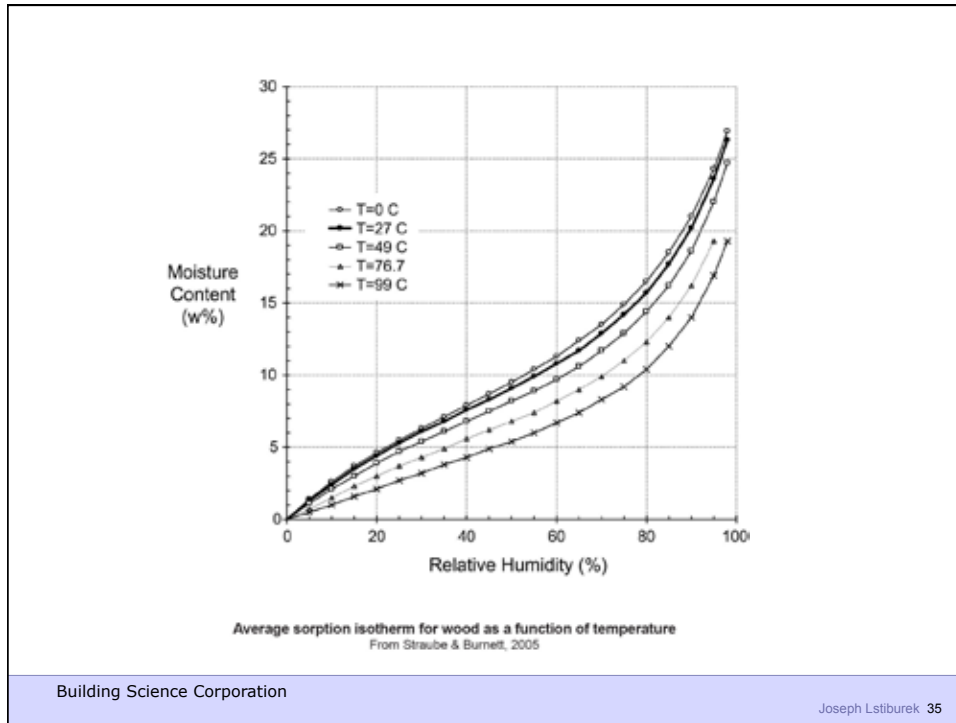

Quick Aside - Vented Attics

Building Science Corporation

Joseph Lstiburek 37

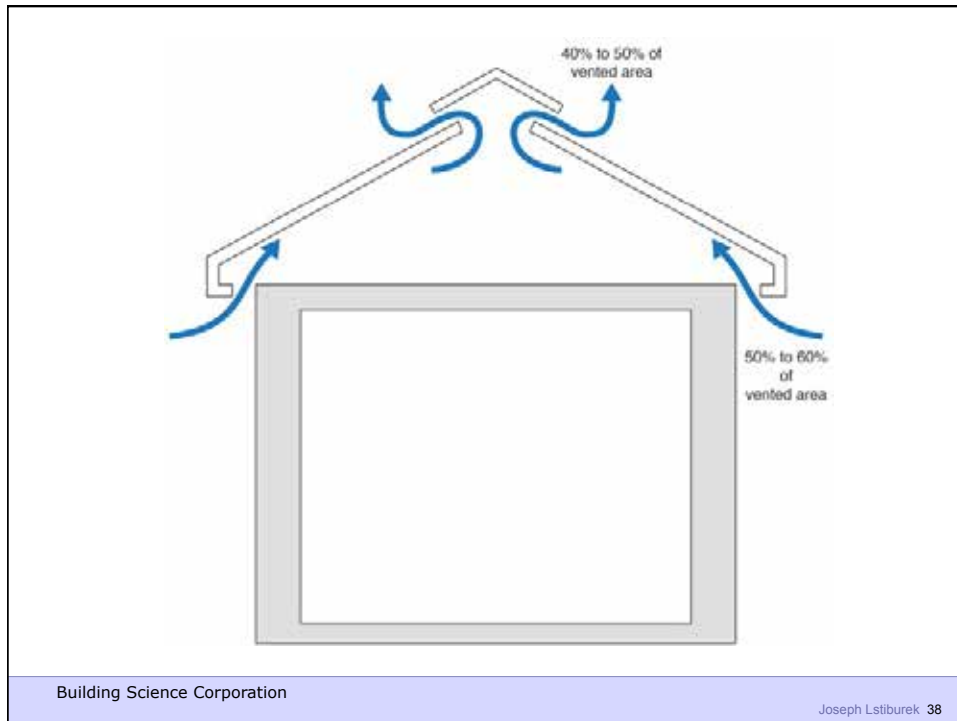

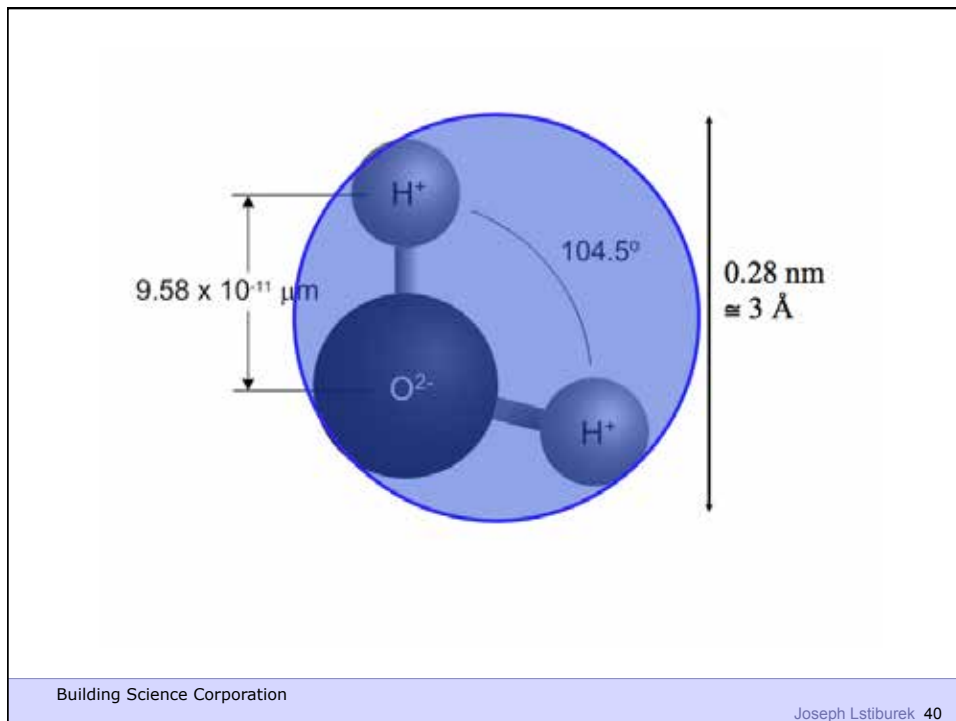
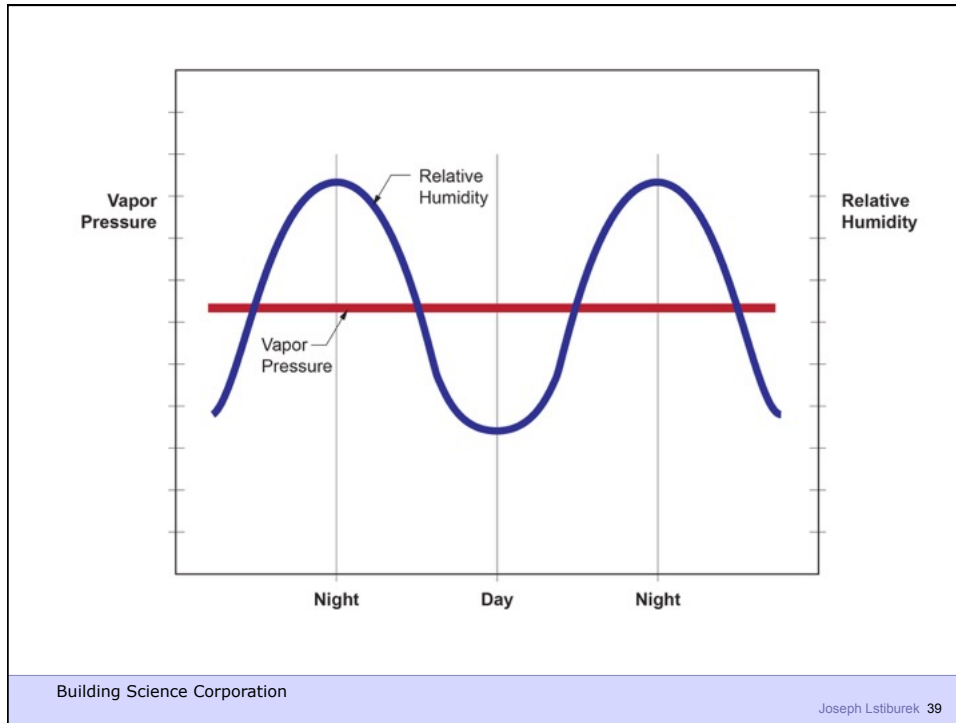

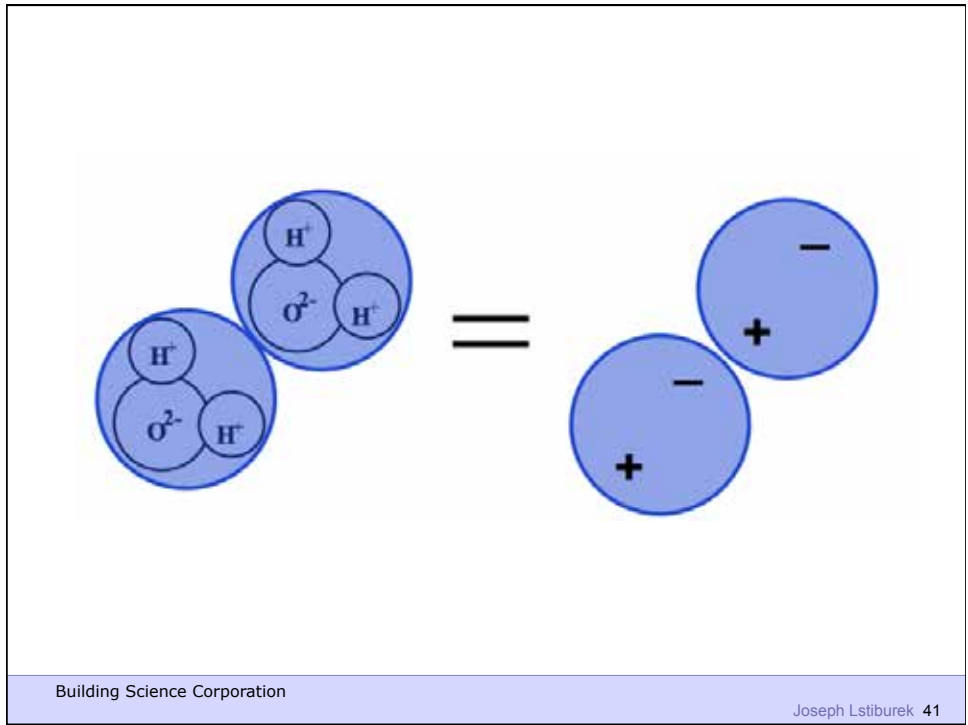

Vapor	Diffusion Convective Flow	Vapor Concentration Air Pressure
Adsorbate	Surface Diffusion	Concentration

Building Science Corporation

Joseph Lstiburek 42

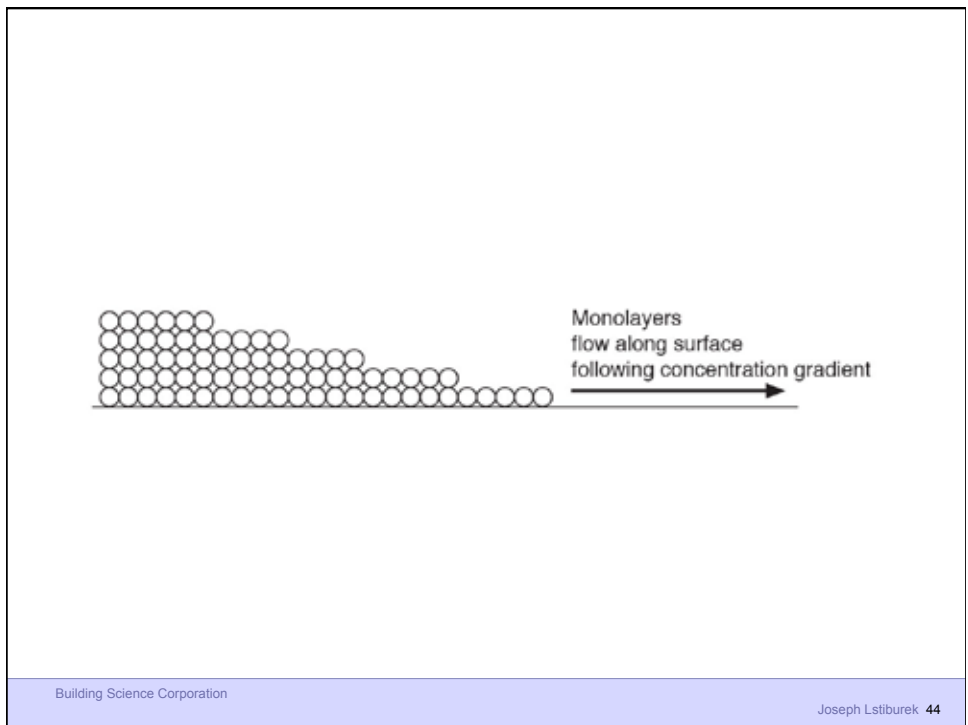
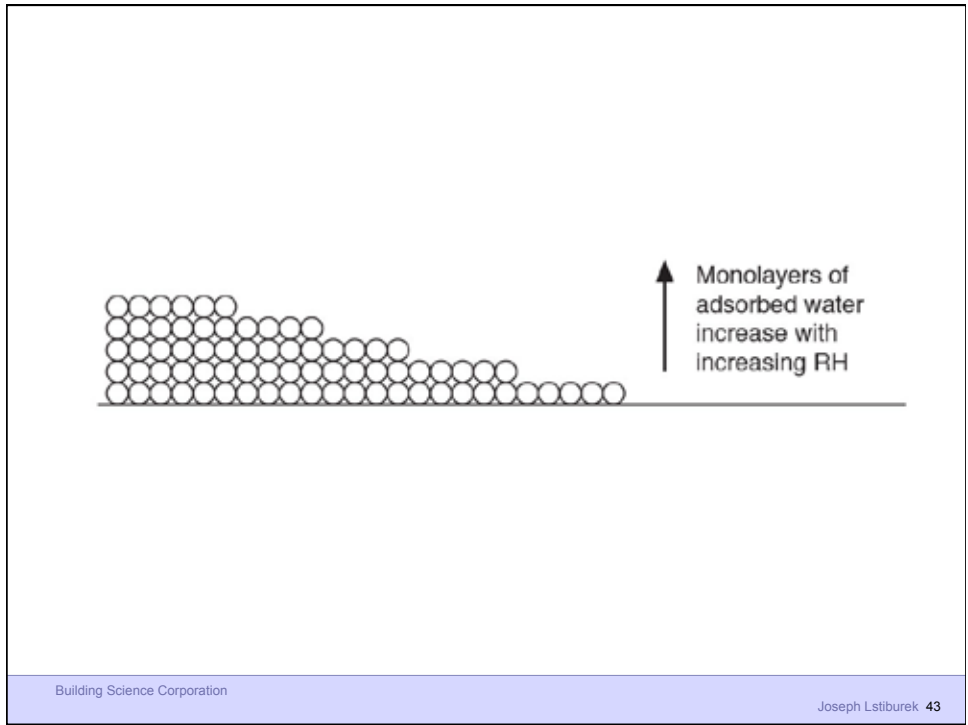

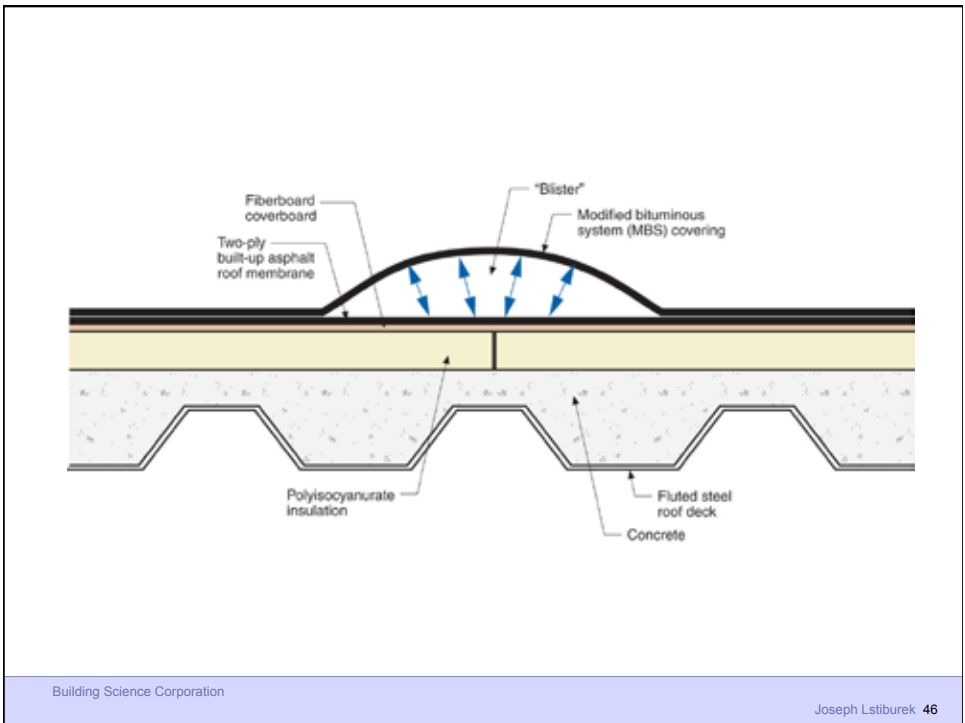

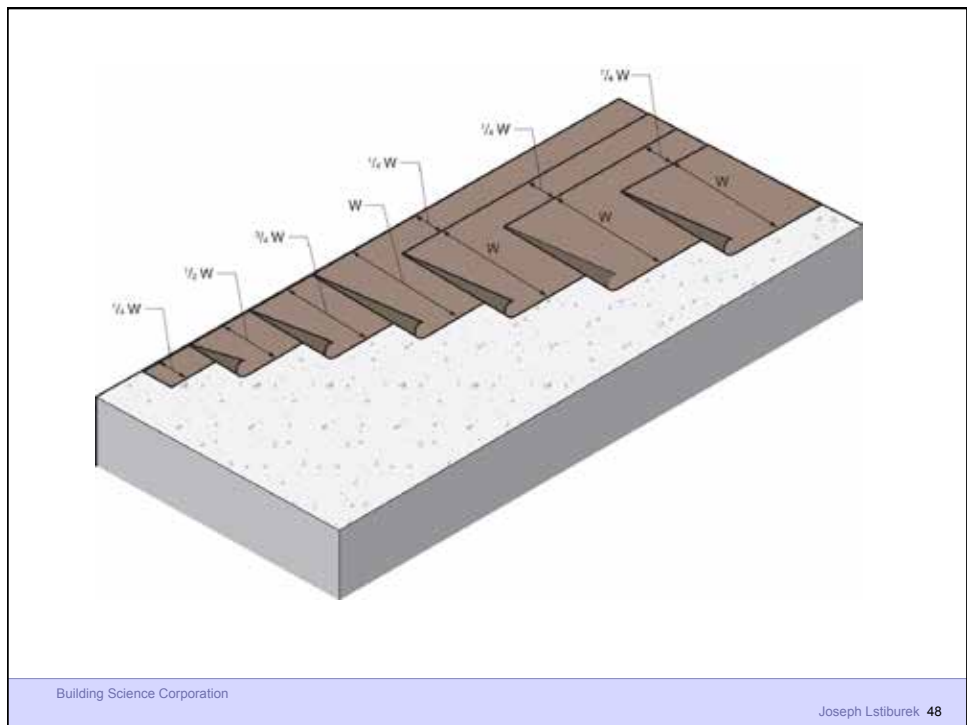
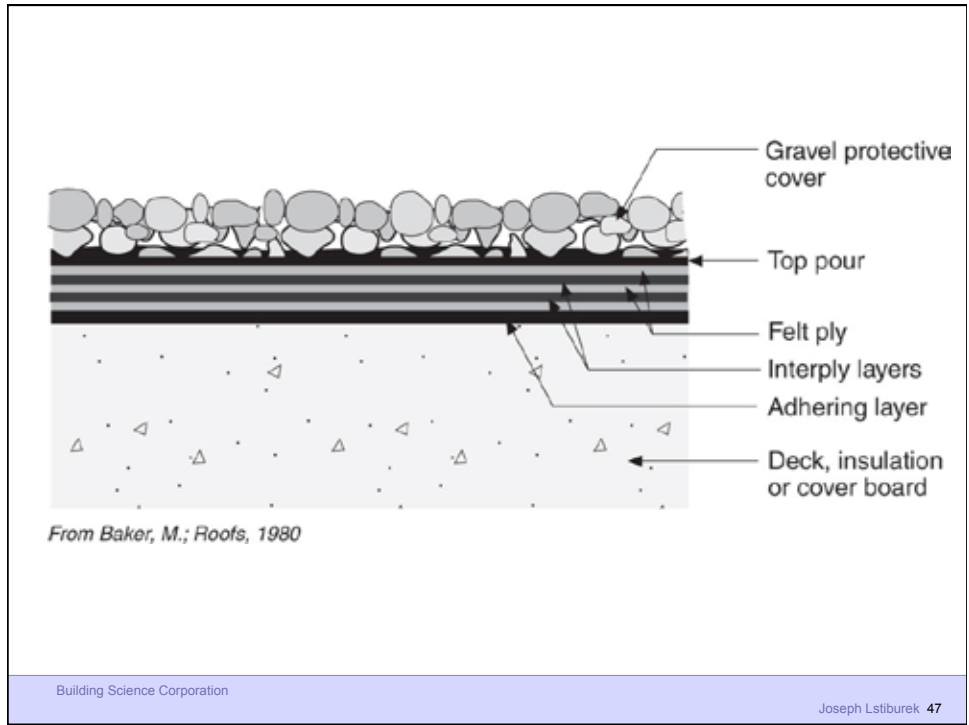

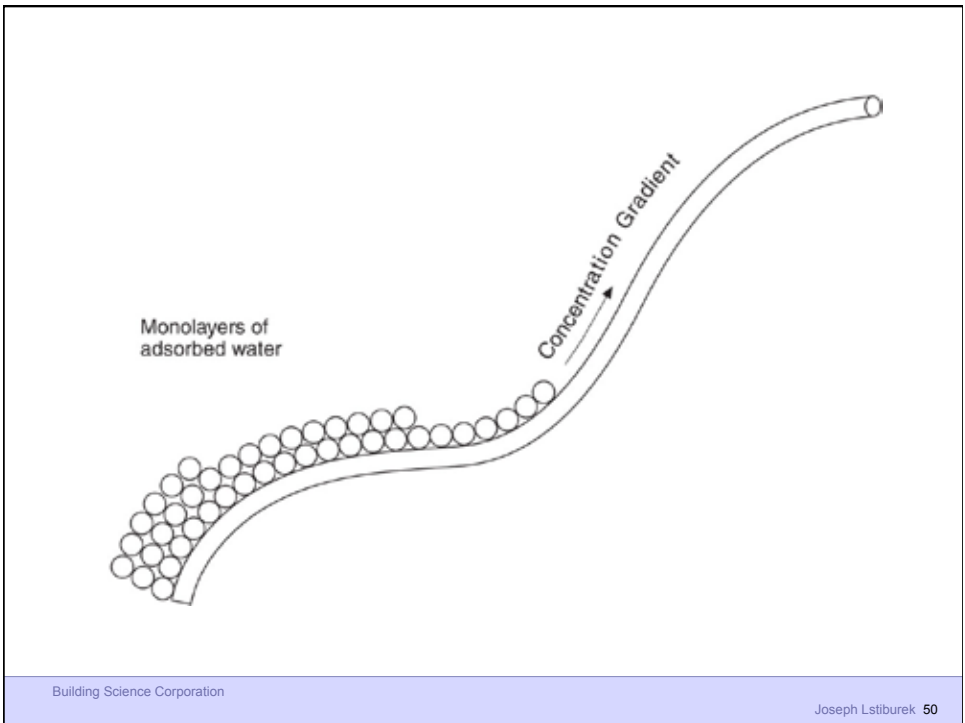
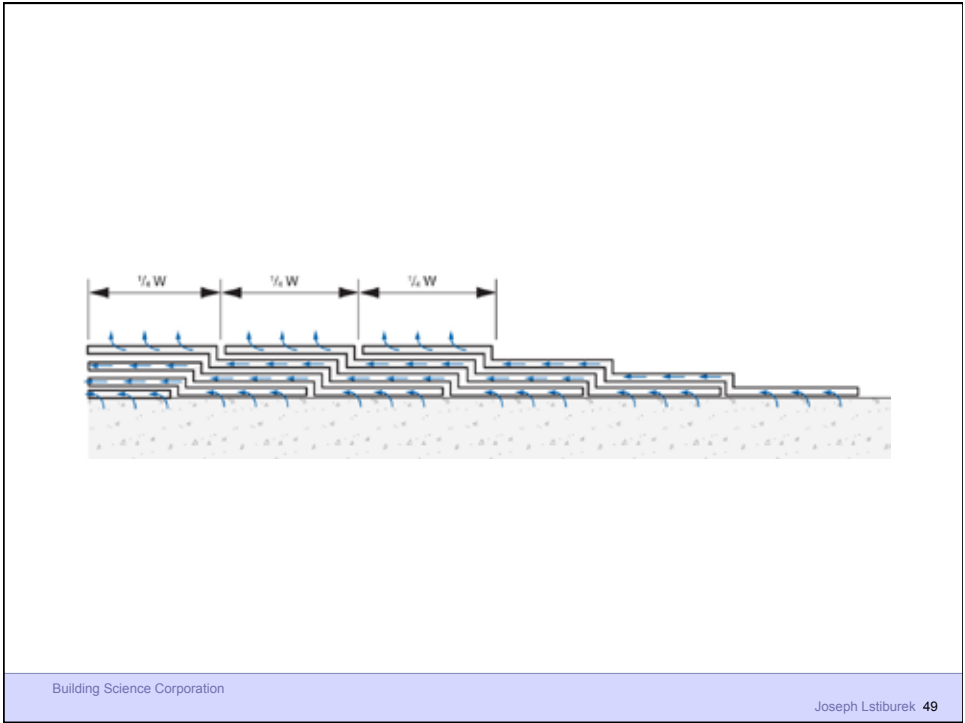

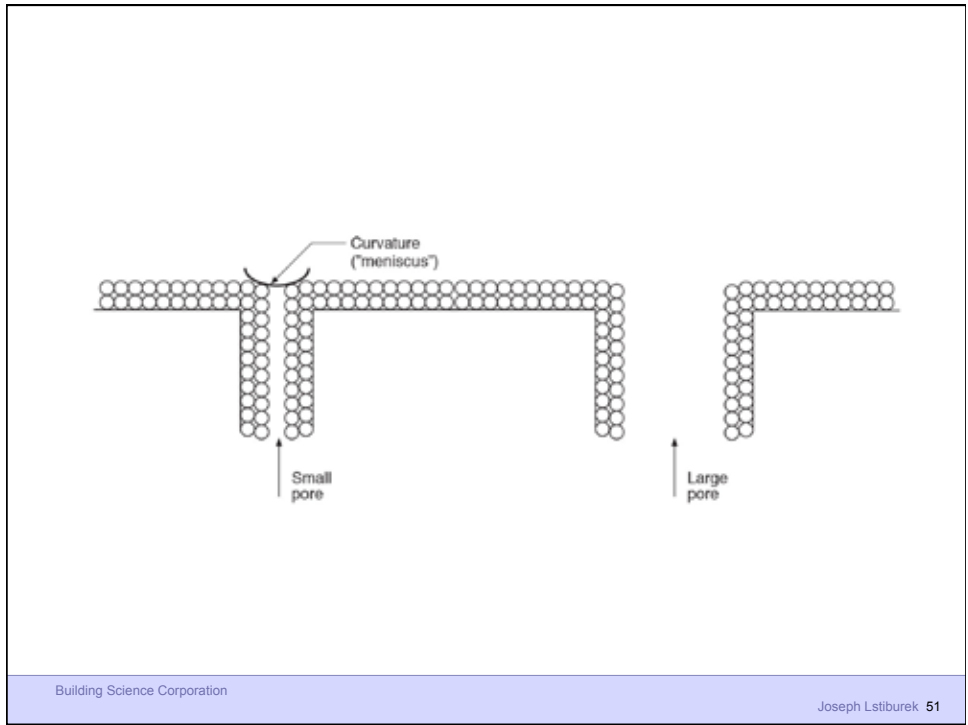

Vapor	Diffusion Convective Flow	Vapor Concentration Air Pressure
Adsorbate	Surface Diffusion	Concentration
Liquid	Capillary Flow	Suction Pressure

Building Science Corporation Joseph Lstiburek 53

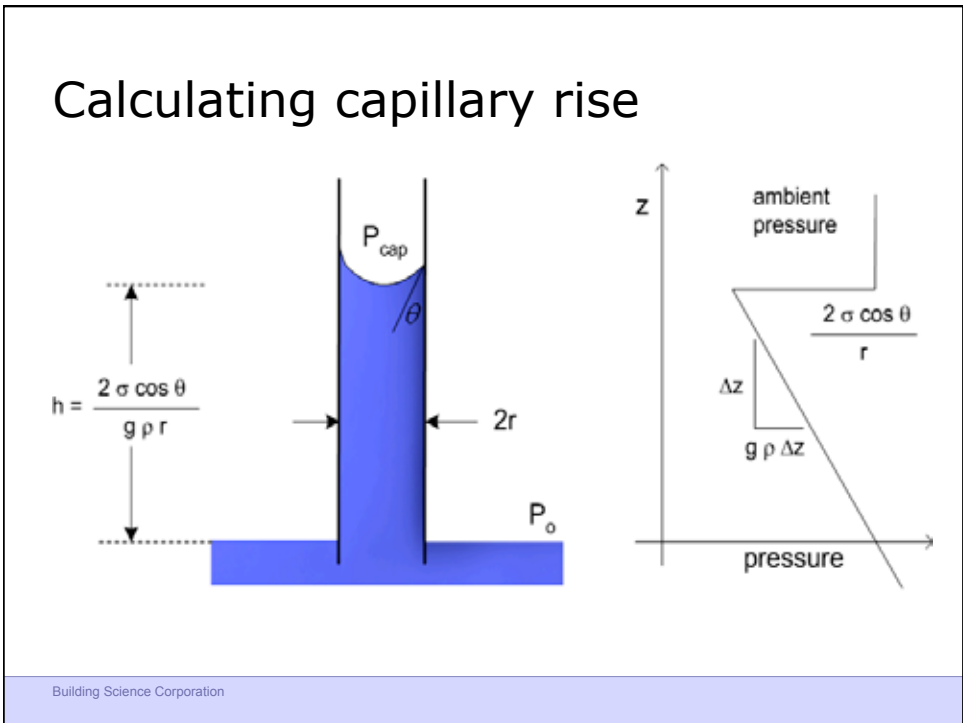

Capillary rise versus diameter

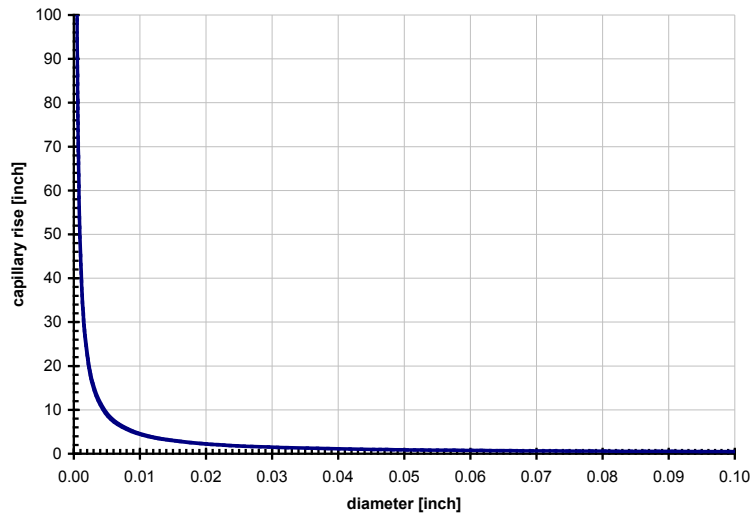

Building Science Corporation

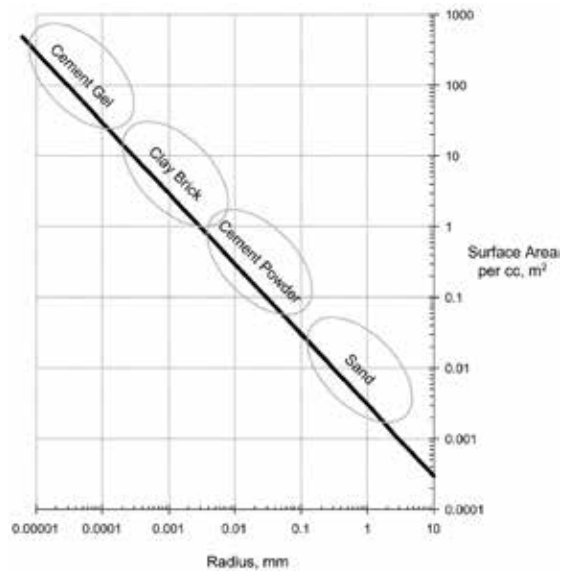

Surface area vs. particle size
From Straube & Burnett, 2005

Building Science Corporation

Joseph Lstiburek 56

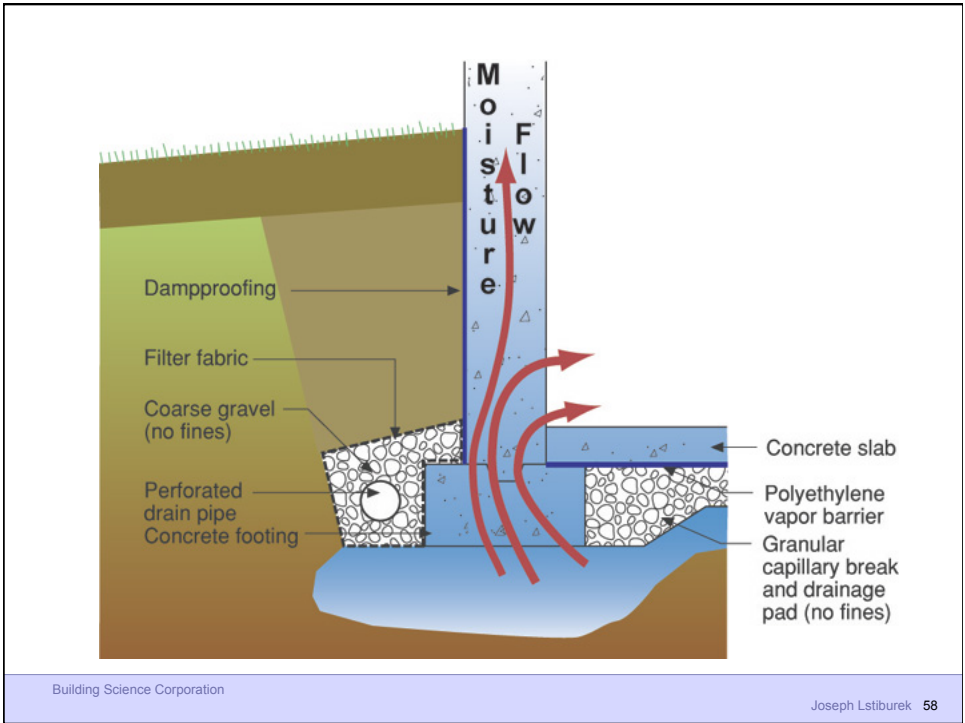
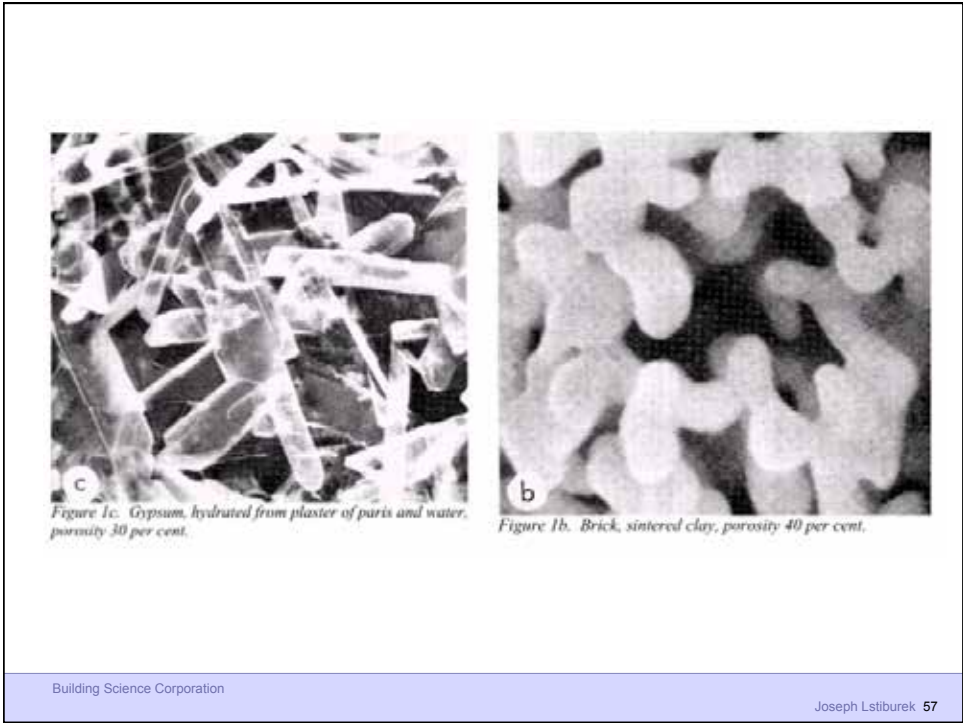

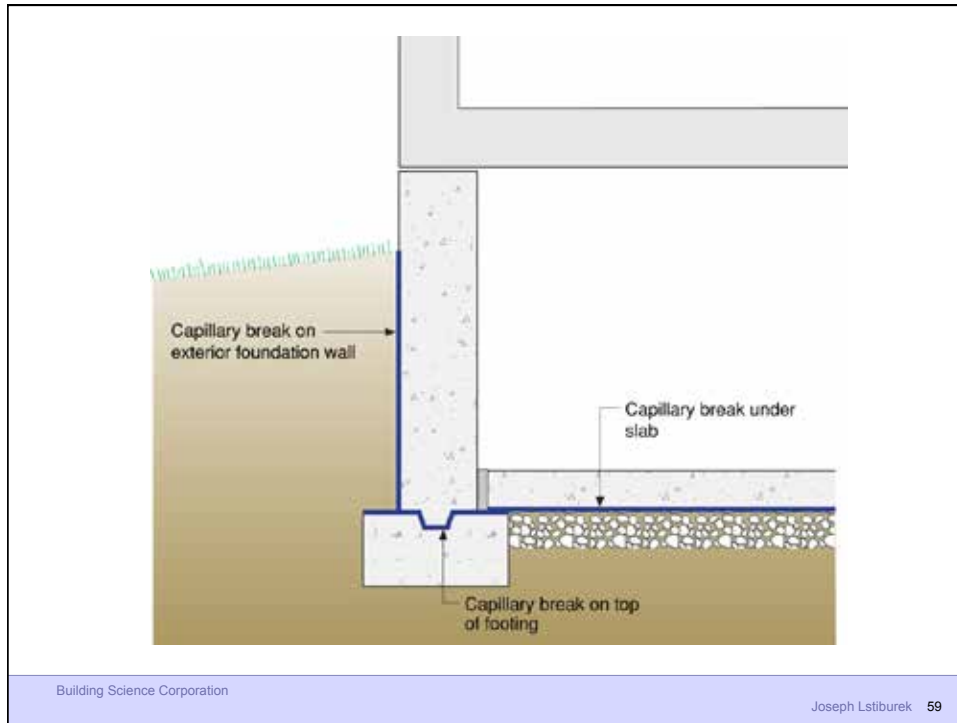

Heat
Air
Moisture

Building Science Corporation

Joseph Lstiburek 60

HAM

Building Science Corporation

Joseph Lstiburek 61

Hygrothermal Analysis

Building Science Corporation

Joseph Lstiburek 62

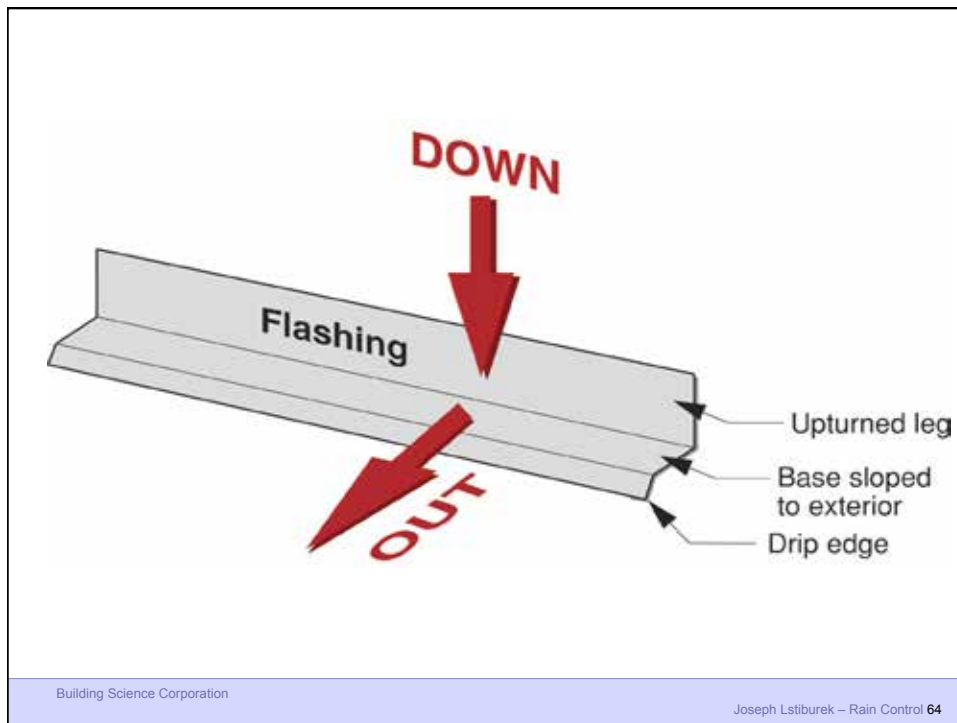
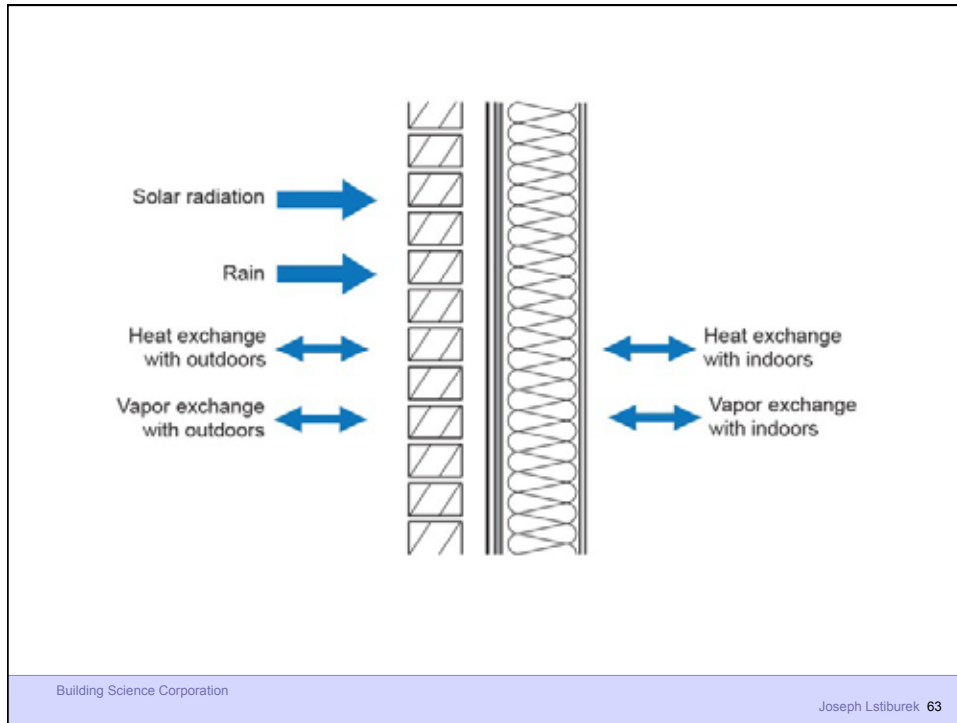

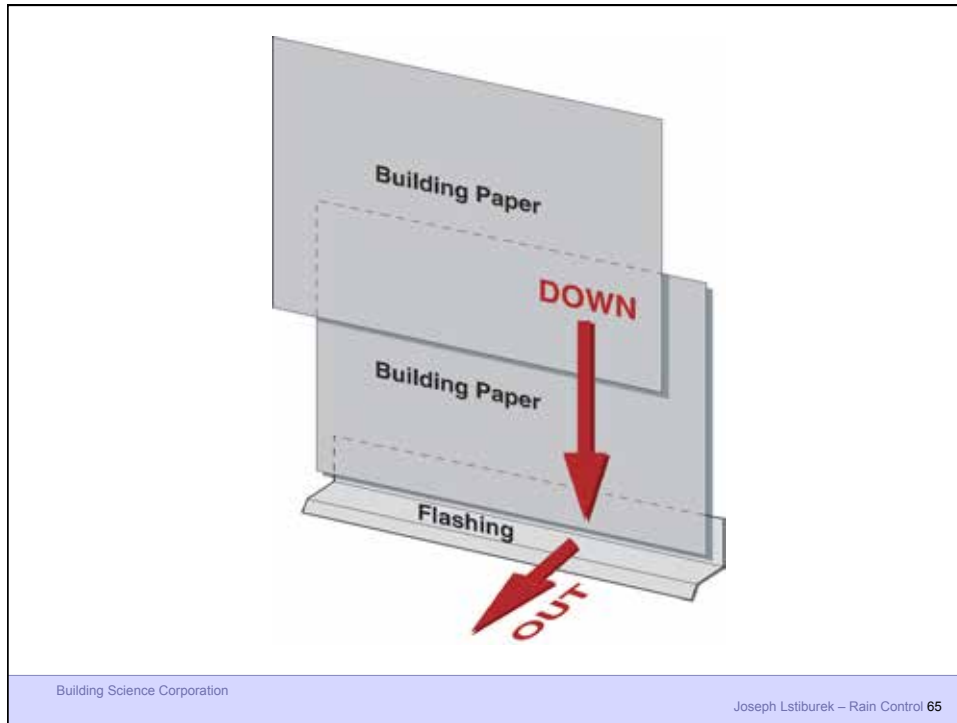

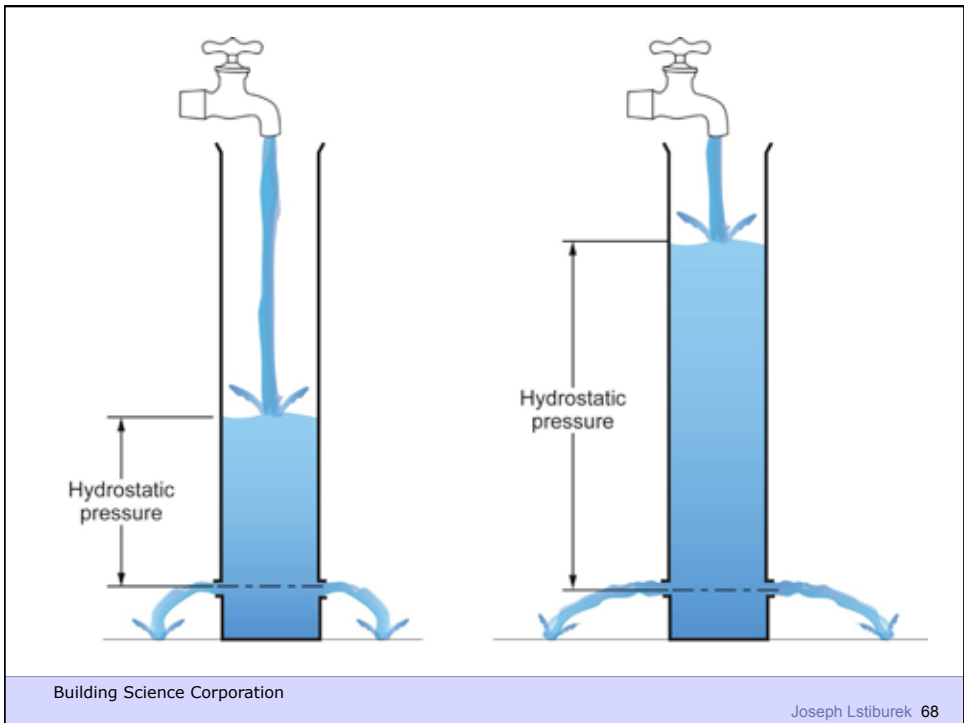



Building Science Corporation

Joseph Lstiburek 69

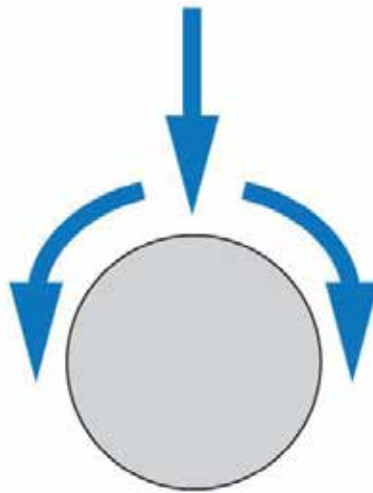

Building Science Corporation

Joseph Lstiburek 70

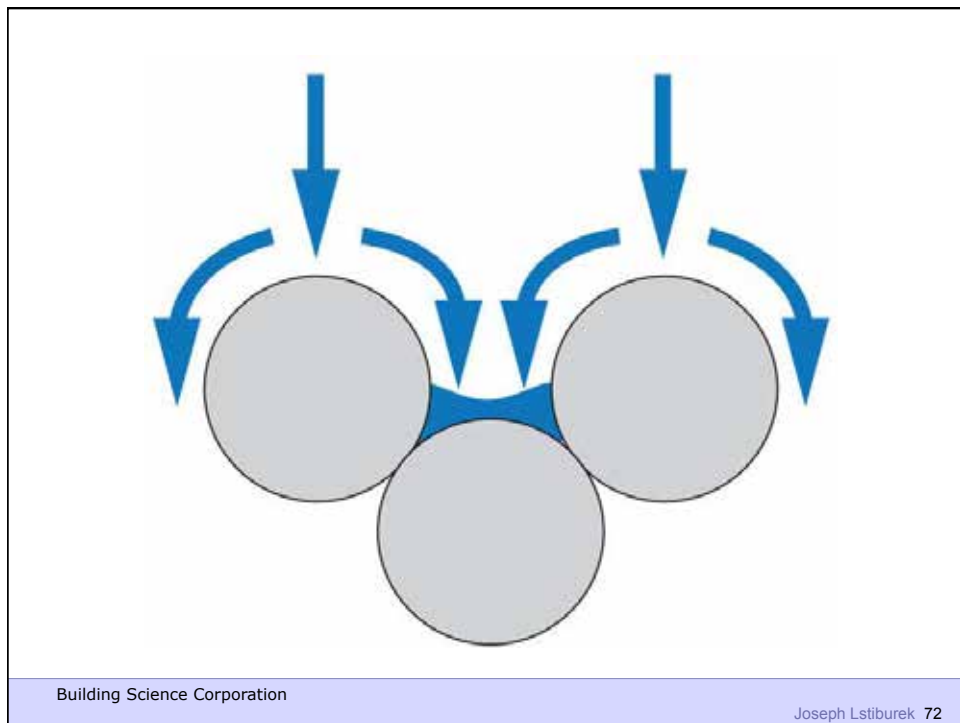
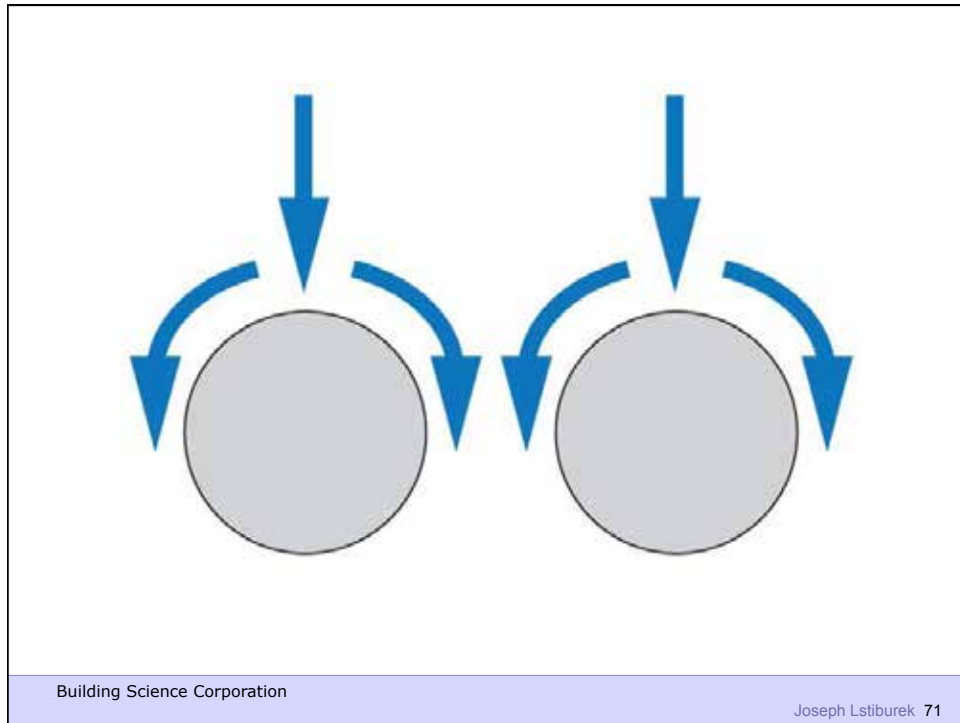



Building Science Corporation

Joseph Lstiburek 73

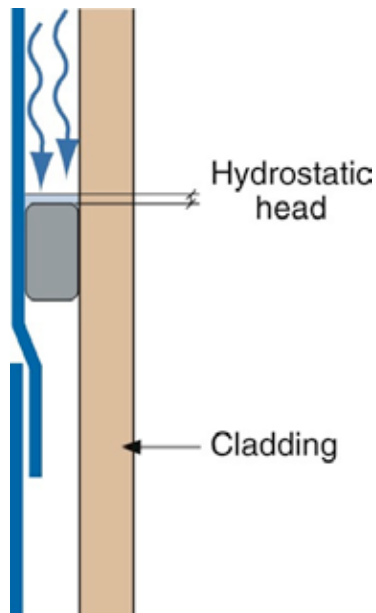

Building Science Corporation

Joseph Lstiburek 74

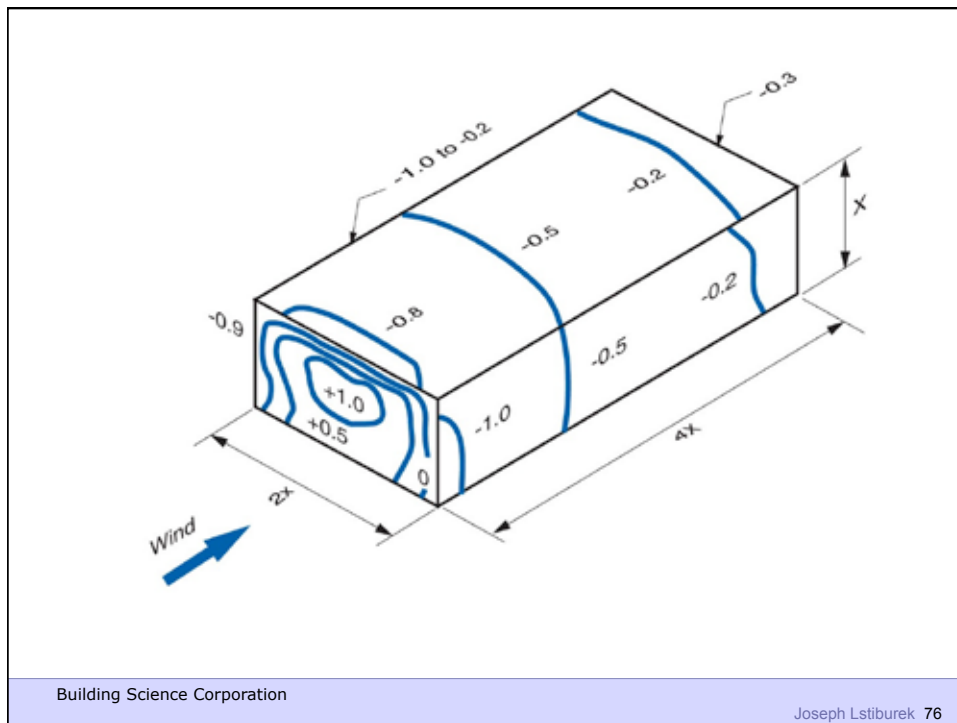
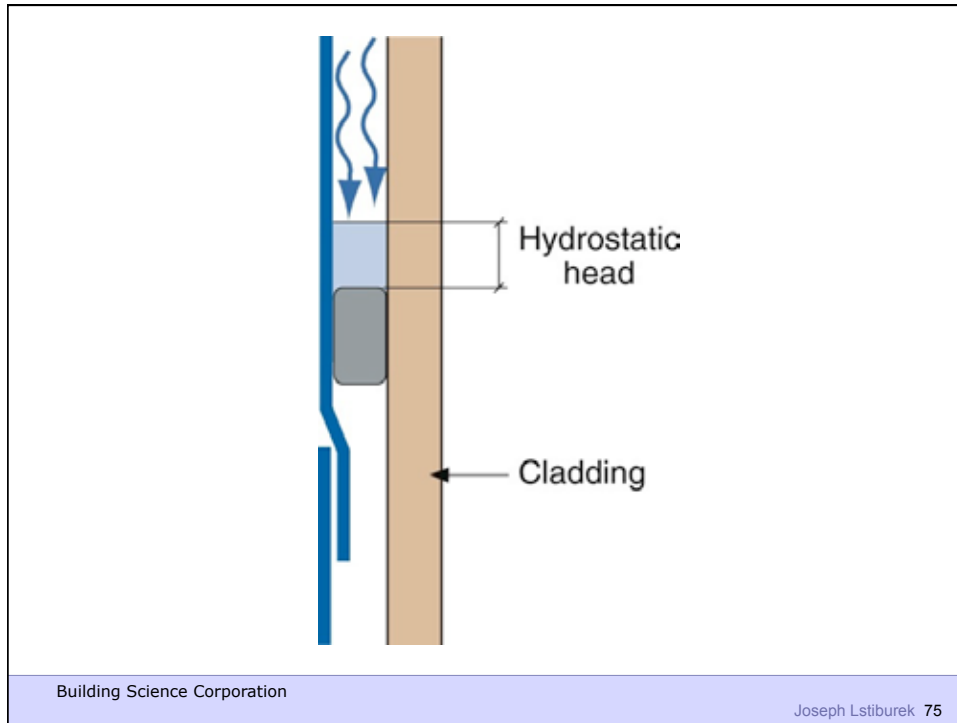

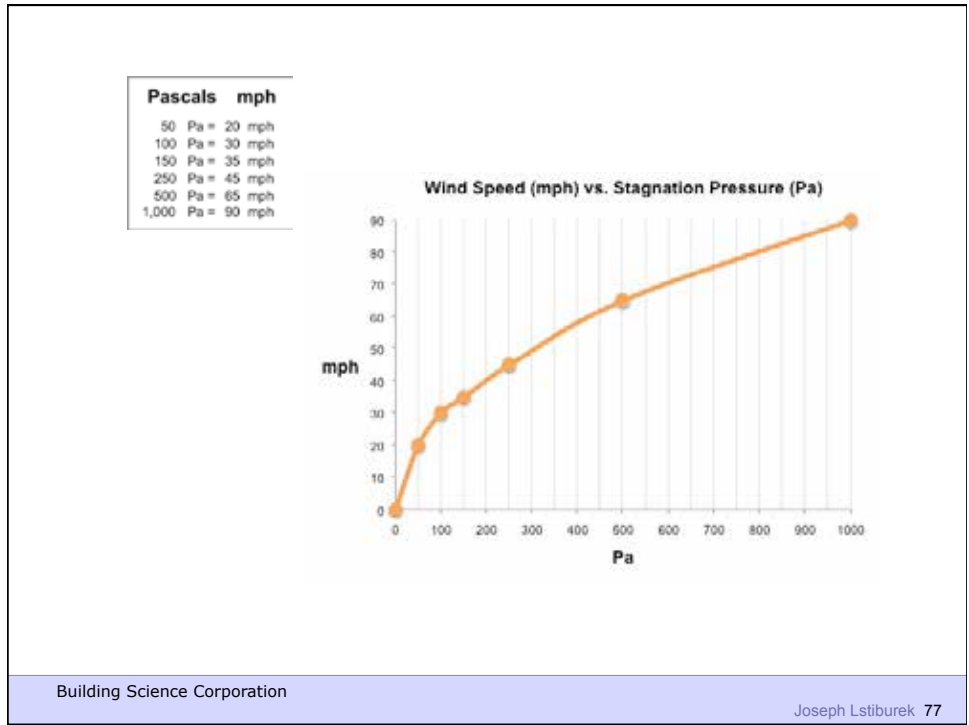



Building Science Corporation

Joseph Lstiburek – Rain Control 79

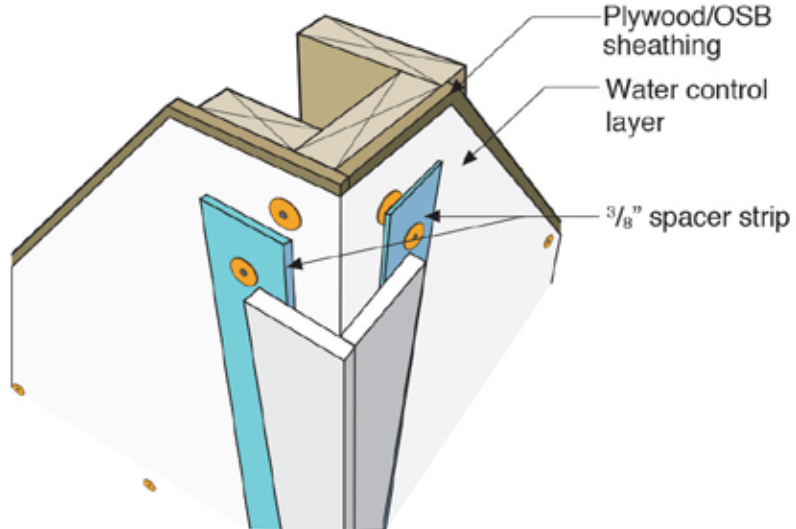

Building Science Corporation

Joseph Lstiburek 80



Building Science Corporation



Building Science Corporation



Building Science Corporation

Joseph Lstiburek 83

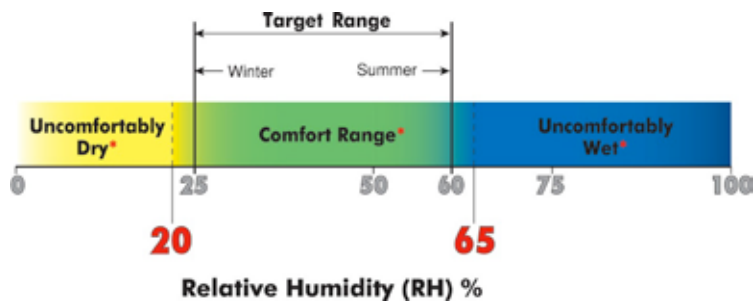

Building Science Corporation

Joseph Lstiburek 84

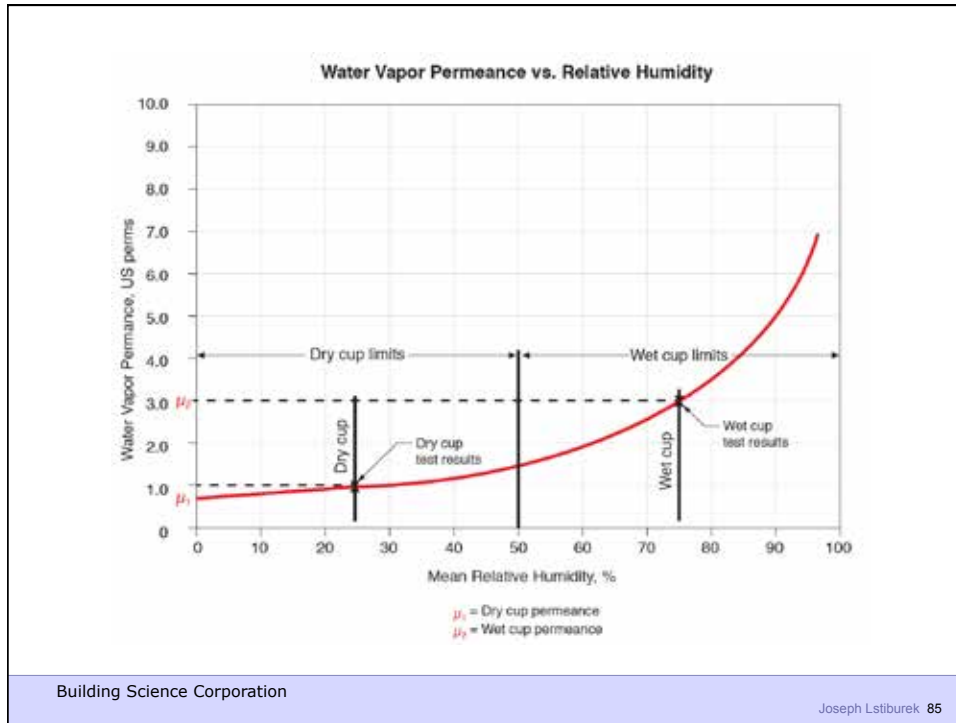

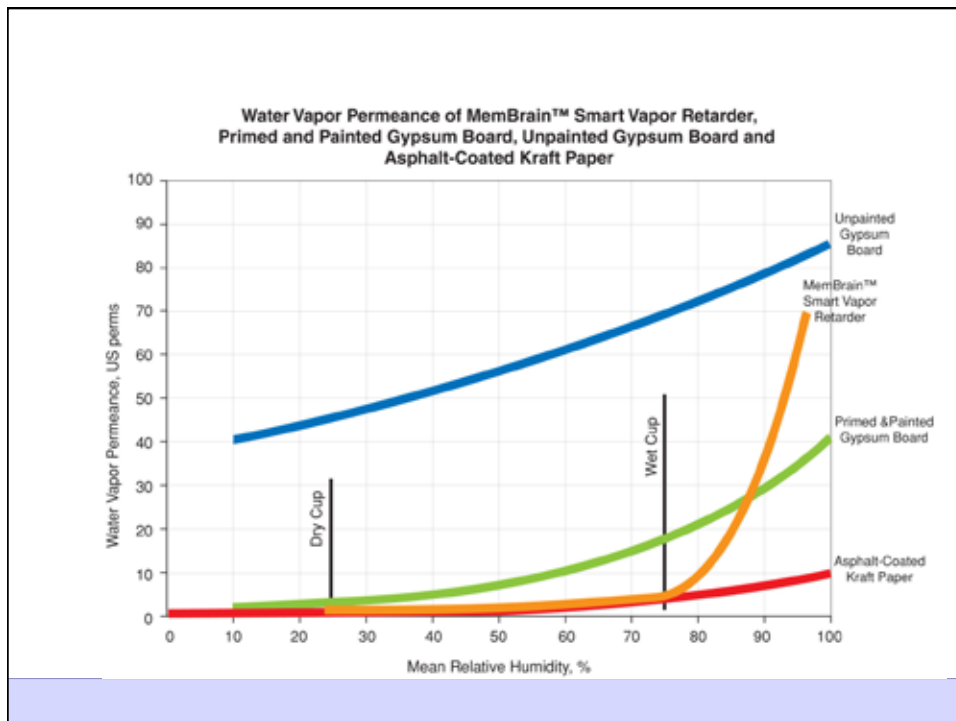
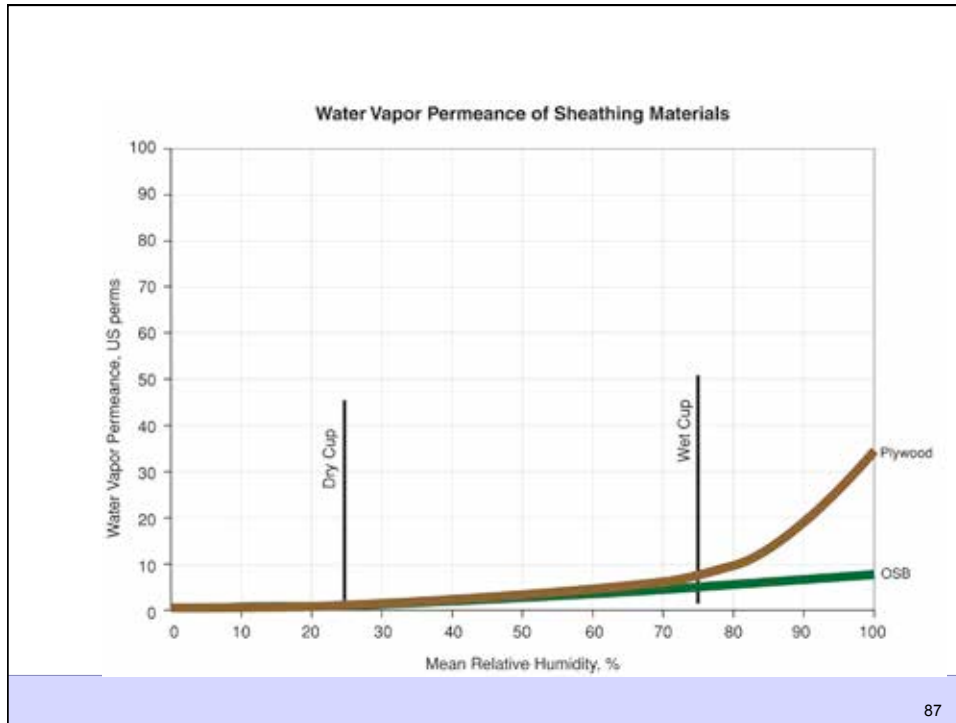

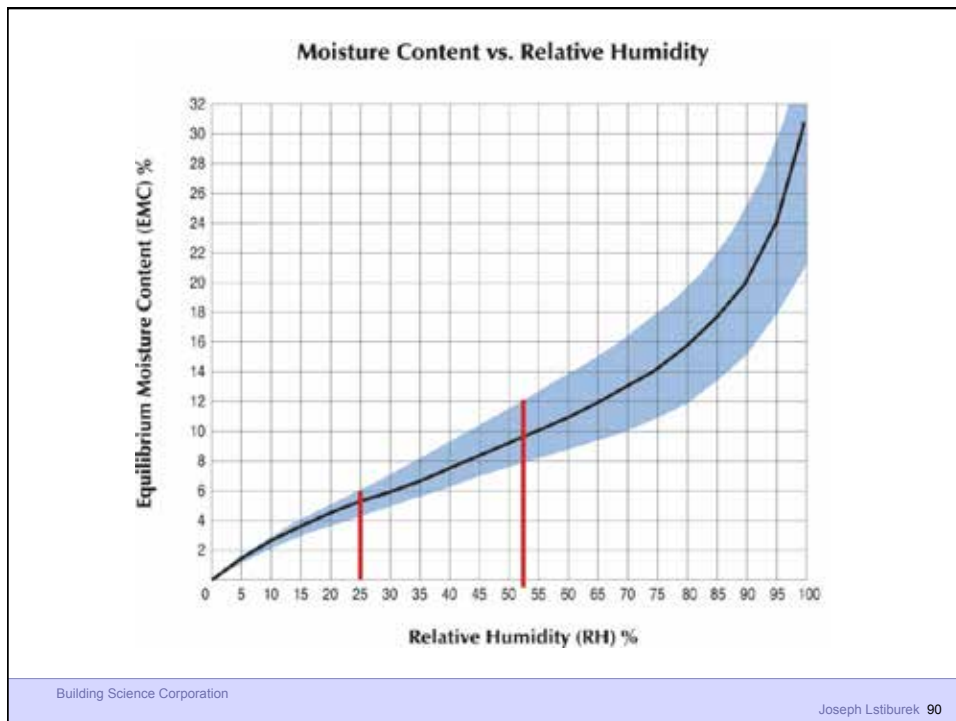
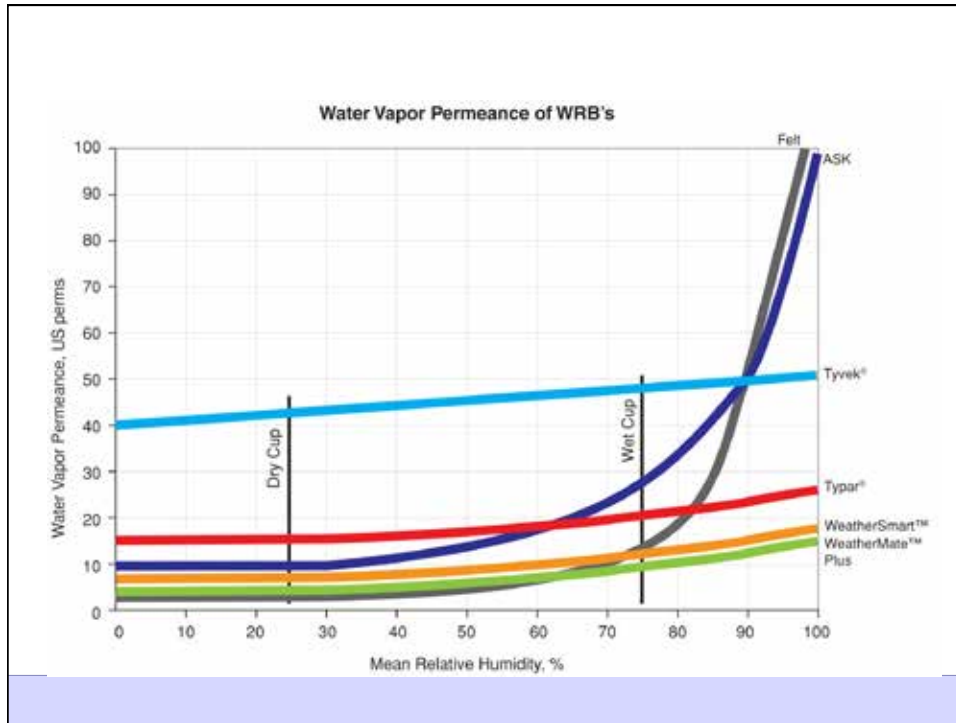

Building Science Corporation

Joseph Lstiburek 90

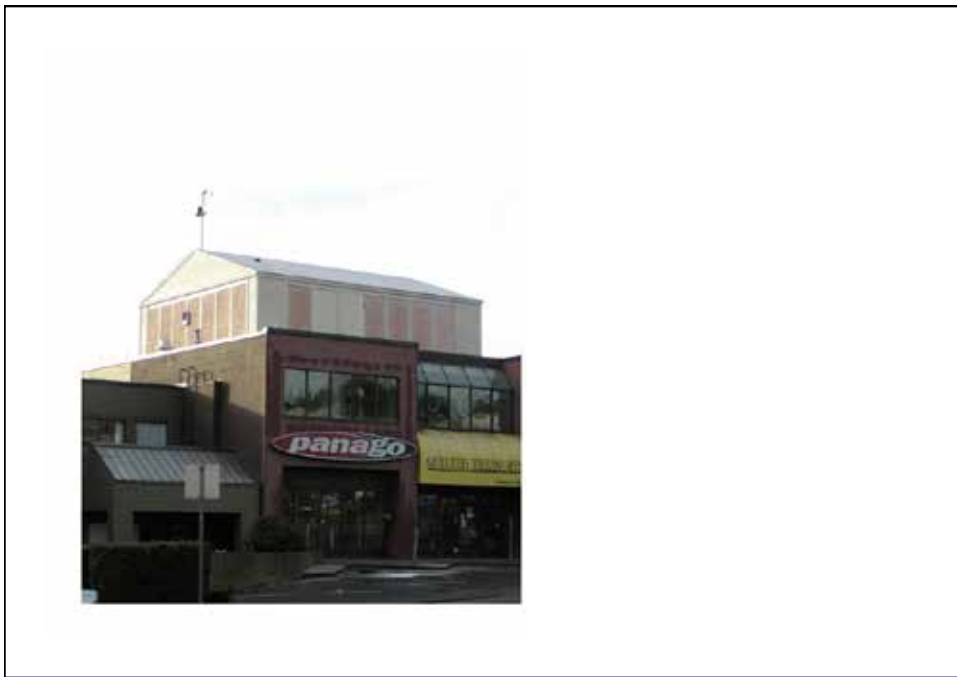

Building Science Corporation

Joseph Lstiburek 92

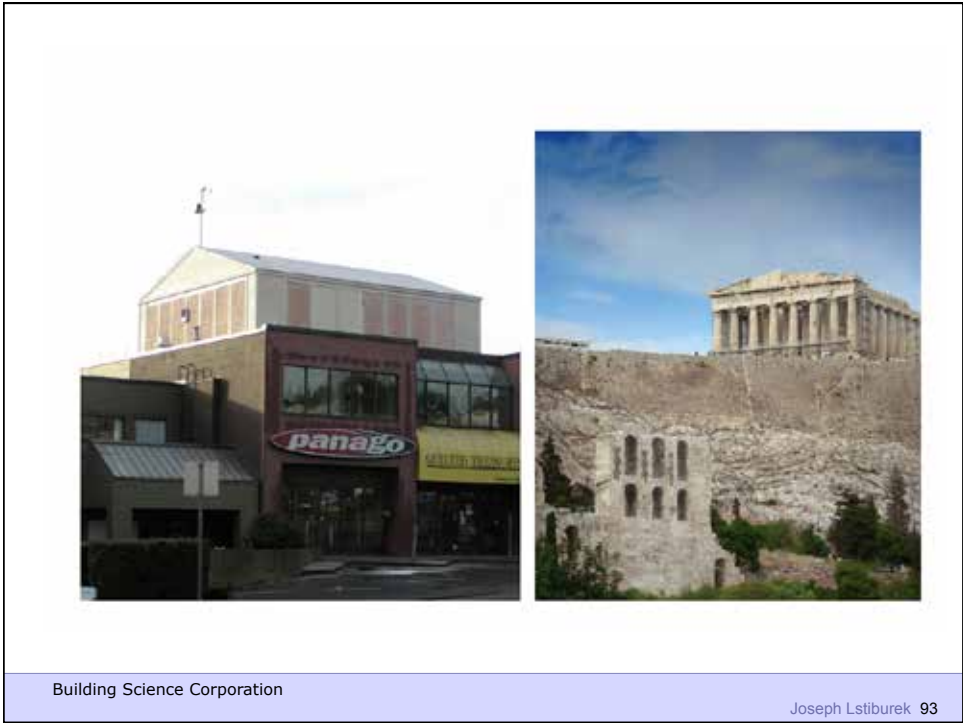

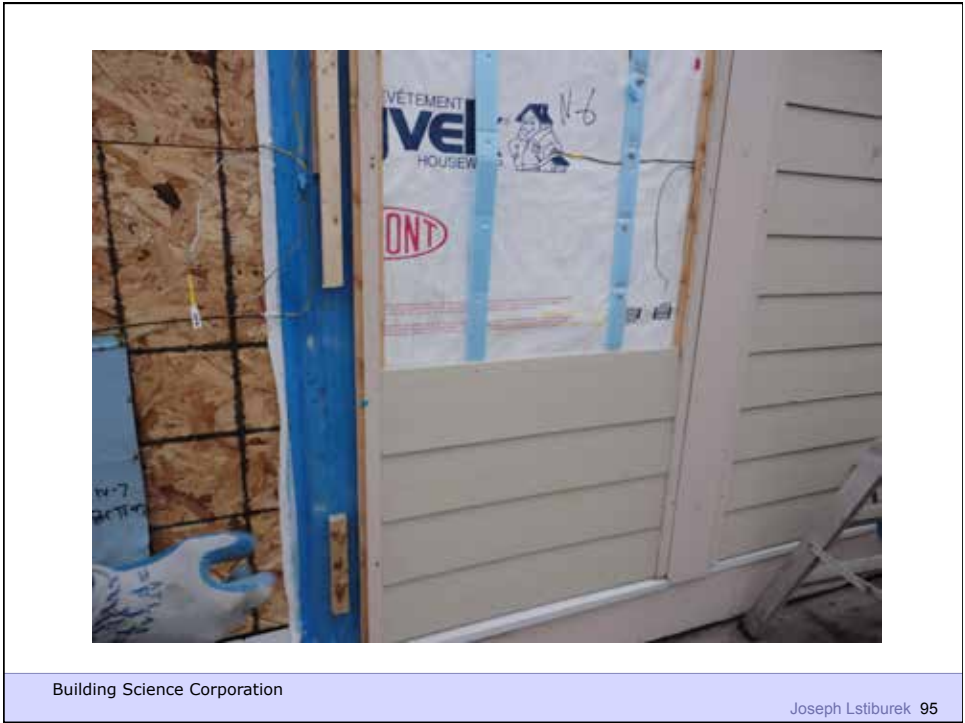



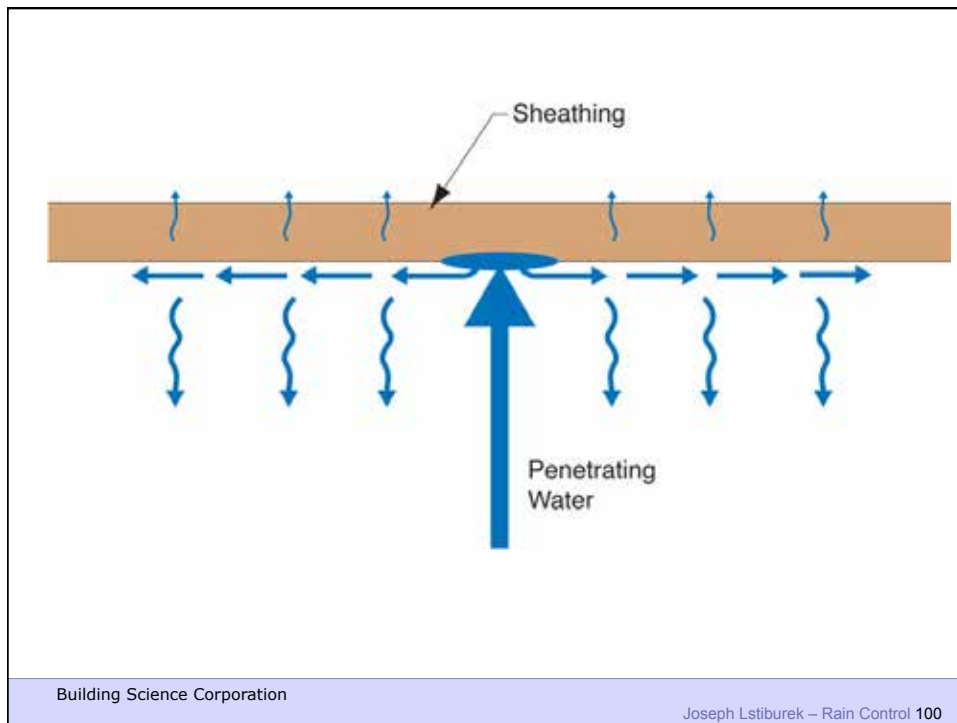
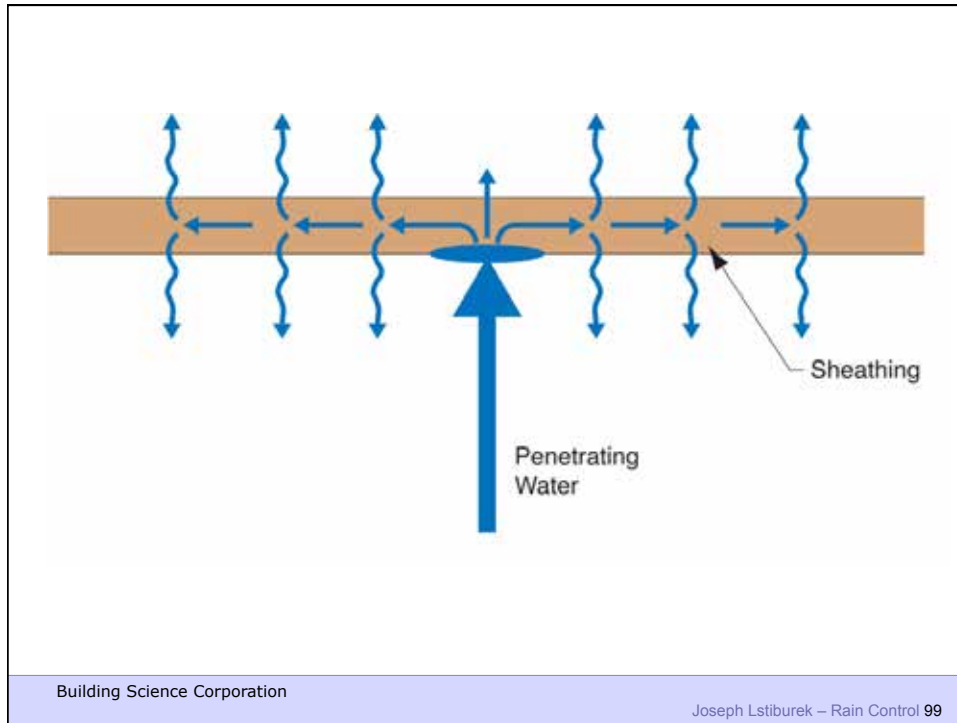



Building Science Corporation

Joseph Lstiburek – Rain Control 101

Rain Screen

Building Science Corporation

Joseph Lstiburek 102

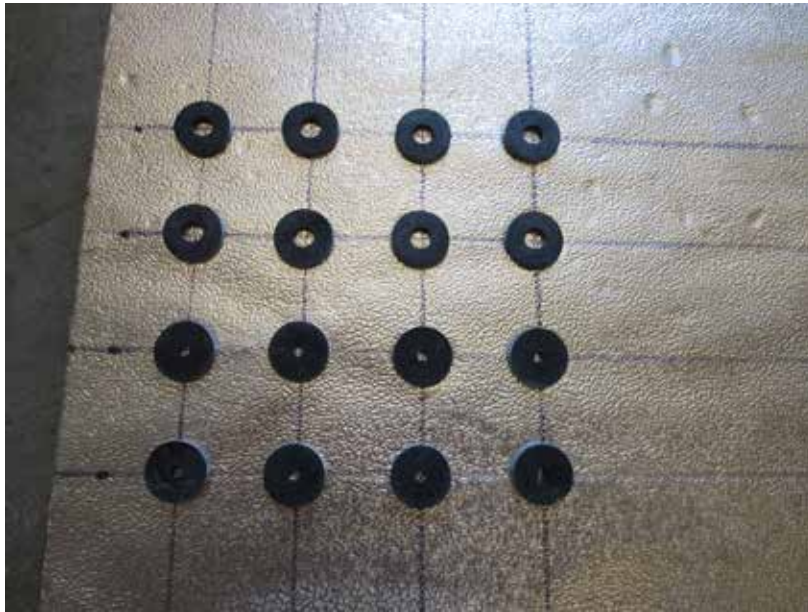

Building Science Corporation

Joseph Lstiburek 103

Beer Screen?

Building Science Corporation

Joseph Lstiburek 104

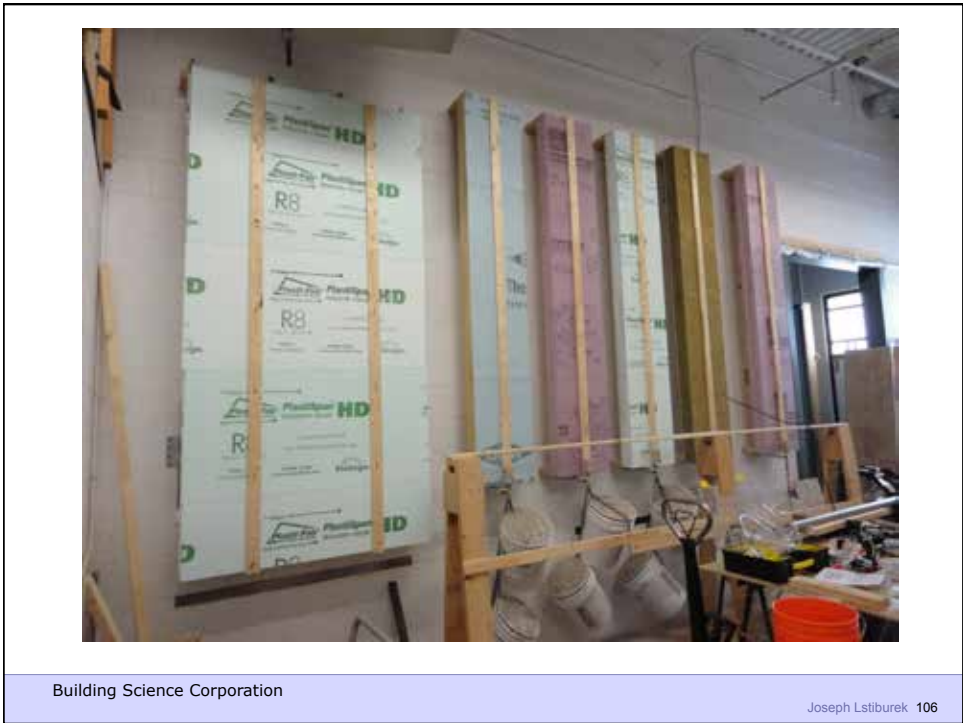
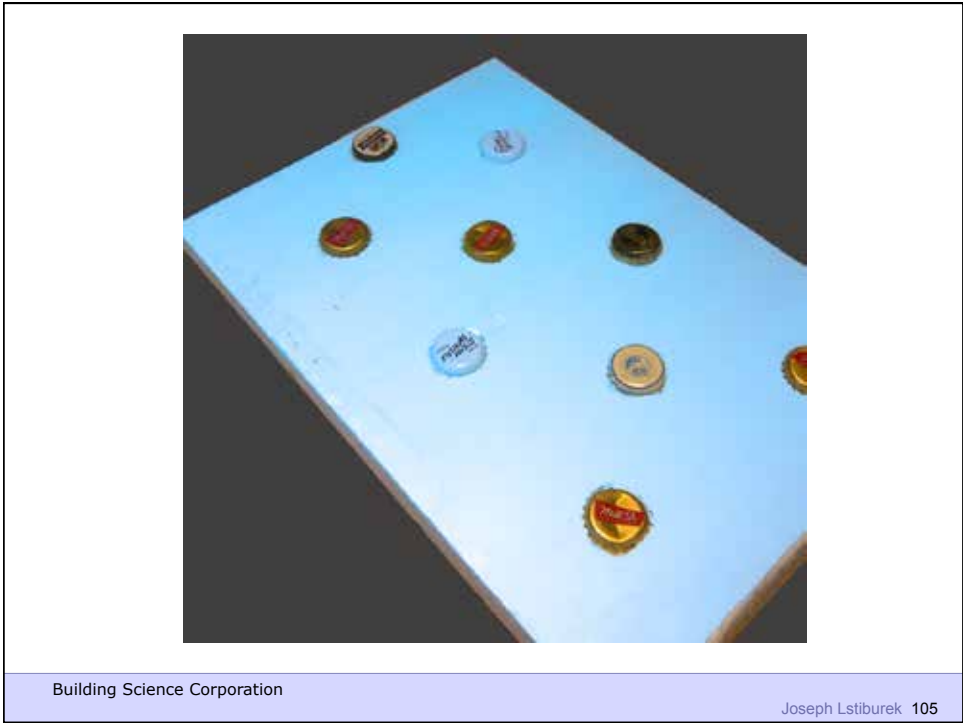





Rockwool

1x3 furring @ 24" o.c.
 #10 screws @ 16" o.c. vertically
 Result: 20 psf cladding weight
 with < 2/100" deflection

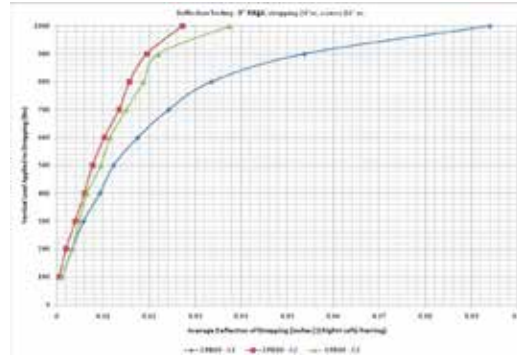

Myth of the Dew Point

