

Joseph Lstiburek, Ph.D., P.Eng, ASHRAE Fellow

Building Science

Adventures In Building Science

www.buildingscience.com

2nd Law of Thermodynamics

Building Science Corporation

Joseph Lstiburek 2

In an isolated system, a process can occur only if it increases the total entropy of the system

Rudolf Clausius

Heat Flow Is From Warm To Cold
Moisture Flow Is From Warm To Cold
Moisture Flow Is From More To Less
Air Flow Is From A Higher Pressure to a
Lower Pressure
Gravity Acts Down

Moisture Flow Is From Warm To Cold
Moisture Flow Is From More To Less

Moisture Flow Is From Warm To Cold
Moisture Flow Is From More To Less

Thermal Gradient – Thermal Diffusion
Concentration Gradient – Molecular Diffusion

Moisture Flow Is From Warm To Cold
Moisture Flow Is From More To Less

Thermal Gradient – Thermal Diffusion
Concentration Gradient – Molecular Diffusion

Vapor Diffusion

Thermodynamic Potential

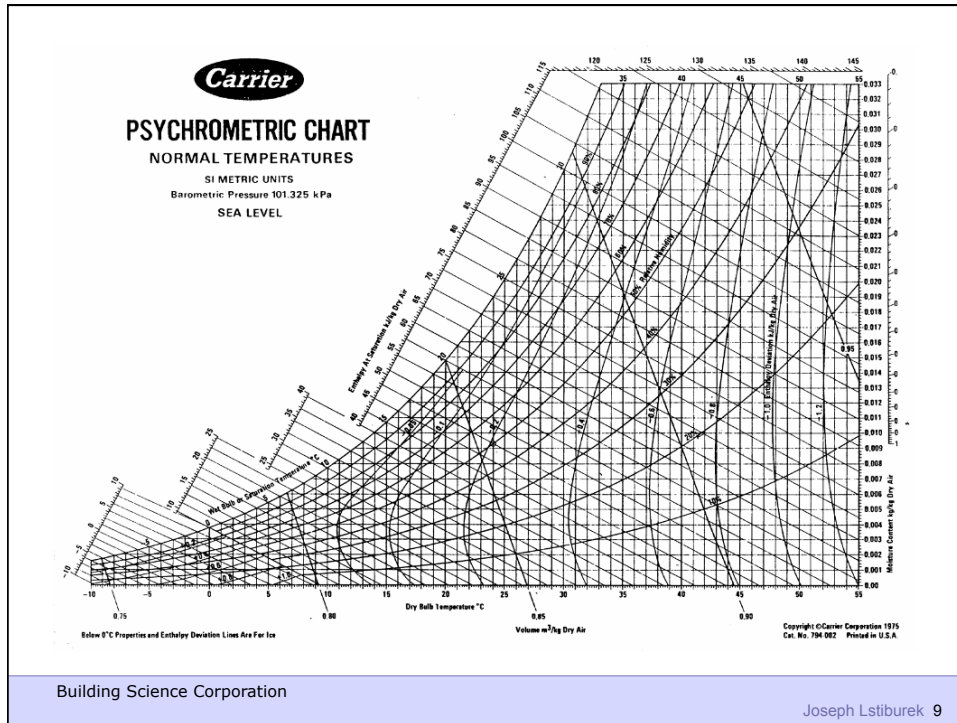

Vapor Barriers – Air Barriers

Building Science Corporation

Joseph Lstiburek 10

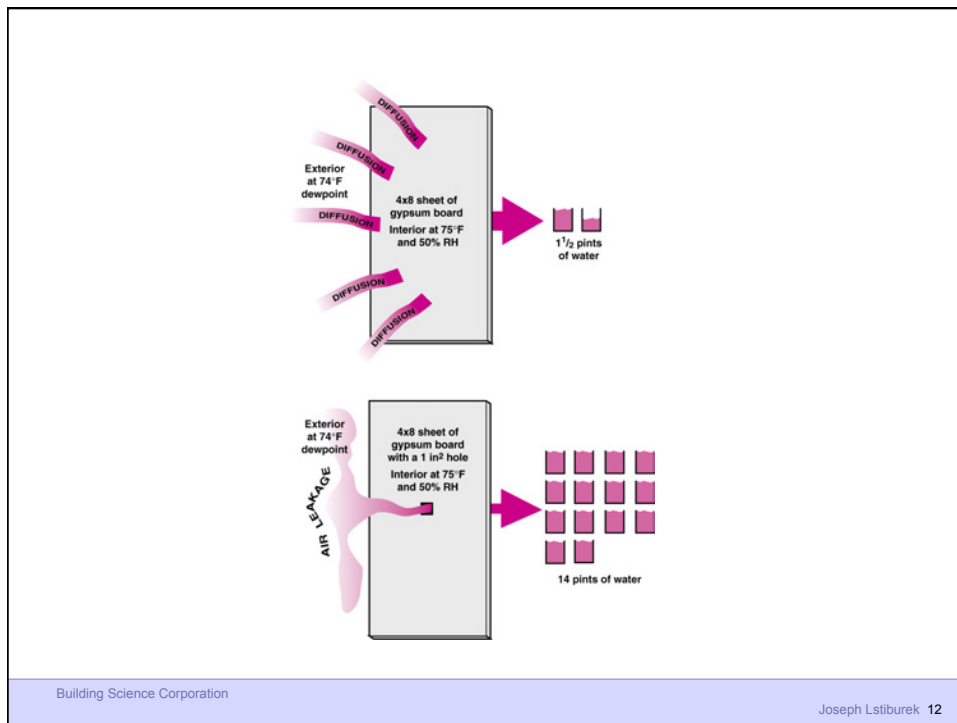
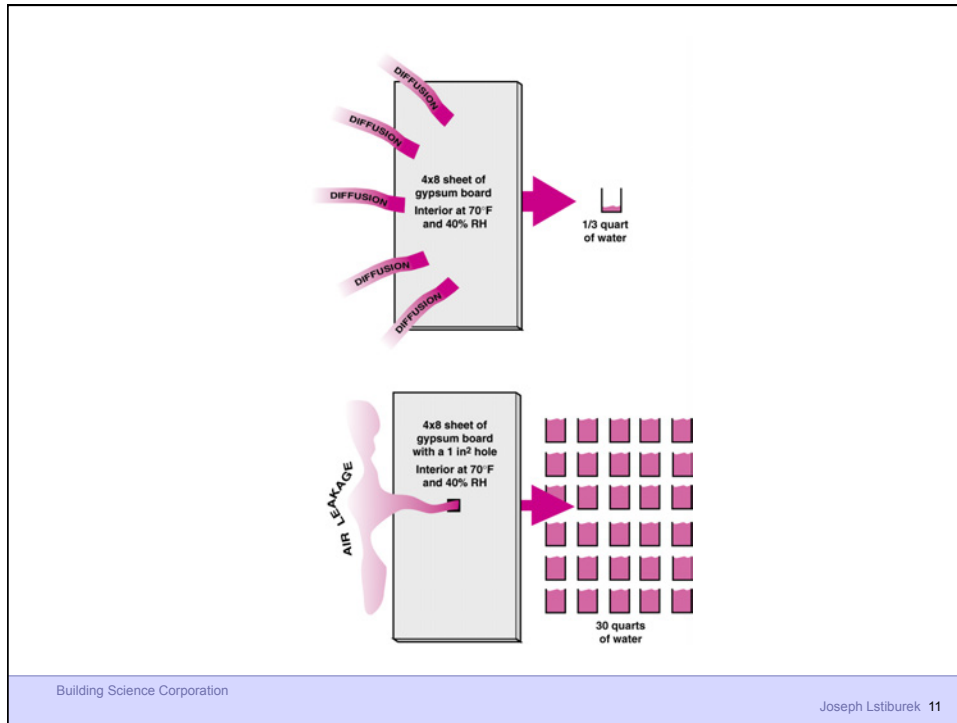

Damage Functions

Building Science Corporation

Joseph Lstiburek 13

Damage Functions
Water
Heat
Ultra Violet Radiation

Building Science Corporation

Joseph Lstiburek 14

The Three Biggest Problems In Buildings Are Water, Water and Water...

Building Science Corporation

Joseph Lstiburek 15

80 Percent of all Construction Problems are Related to Water

Building Science Corporation

Joseph Lstiburek 16

Heat
Air
Moisture

HAM

Hygrothermal Analysis

Building Science Corporation

Joseph Lstiburek 19

What is a Building?

Building Science Corporation

Joseph Lstiburek 20

A Building is an Environmental Separator

Building Science Corporation

Joseph Lstiburek 21

- Control heat flow
- Control airflow
- Control water vapor flow
- Control rain
- Control ground water
- Control light and solar radiation
- Control noise and vibrations
- Control contaminants, environmental hazards and odors
- Control insects, rodents and vermin
- Control fire
- Provide strength and rigidity
- Be durable
- Be aesthetically pleasing
- Be economical

Building Science Corporation

Joseph Lstiburek 22

Water Control Layer
Air Control Layer
Vapor Control Layer
Thermal Control Layer

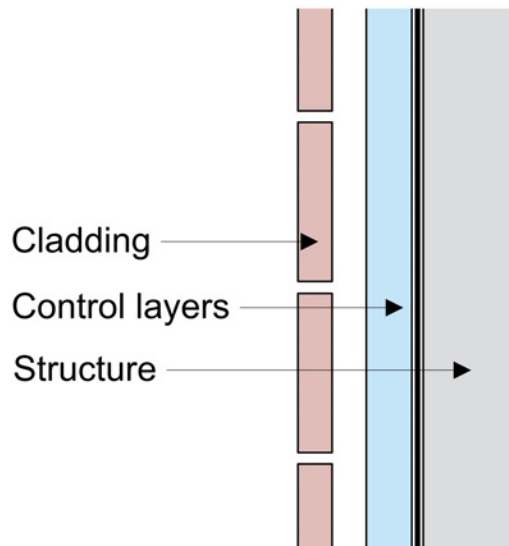

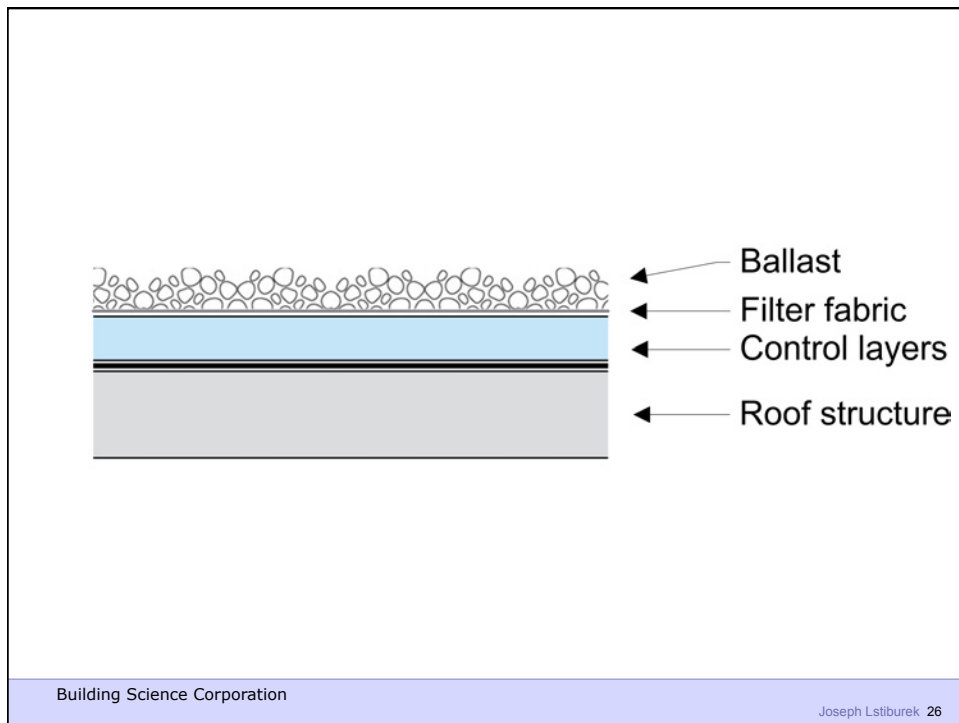
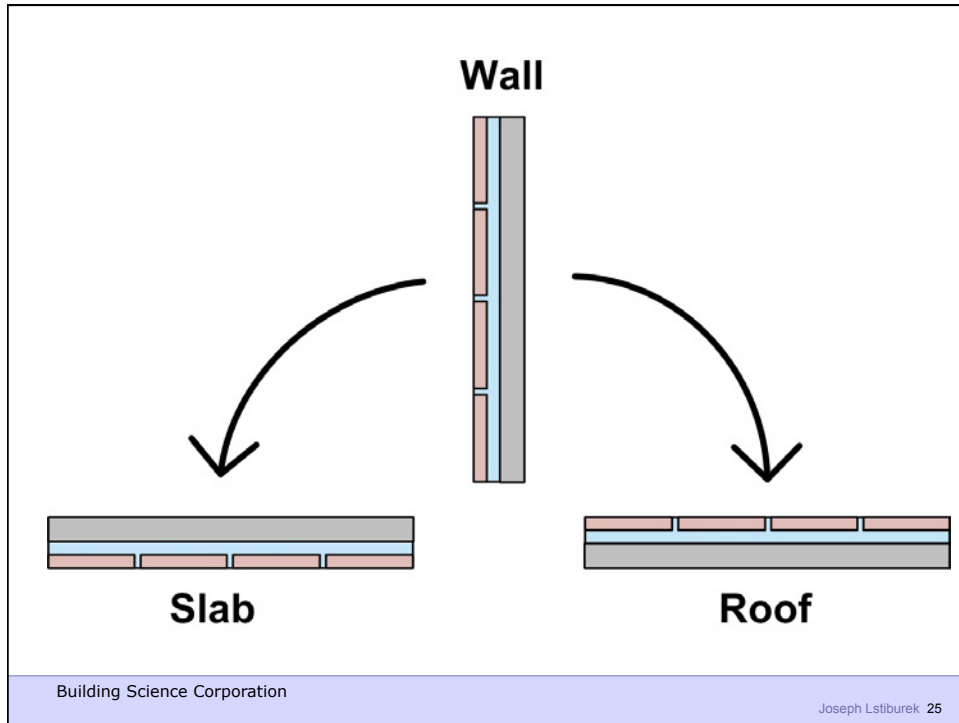

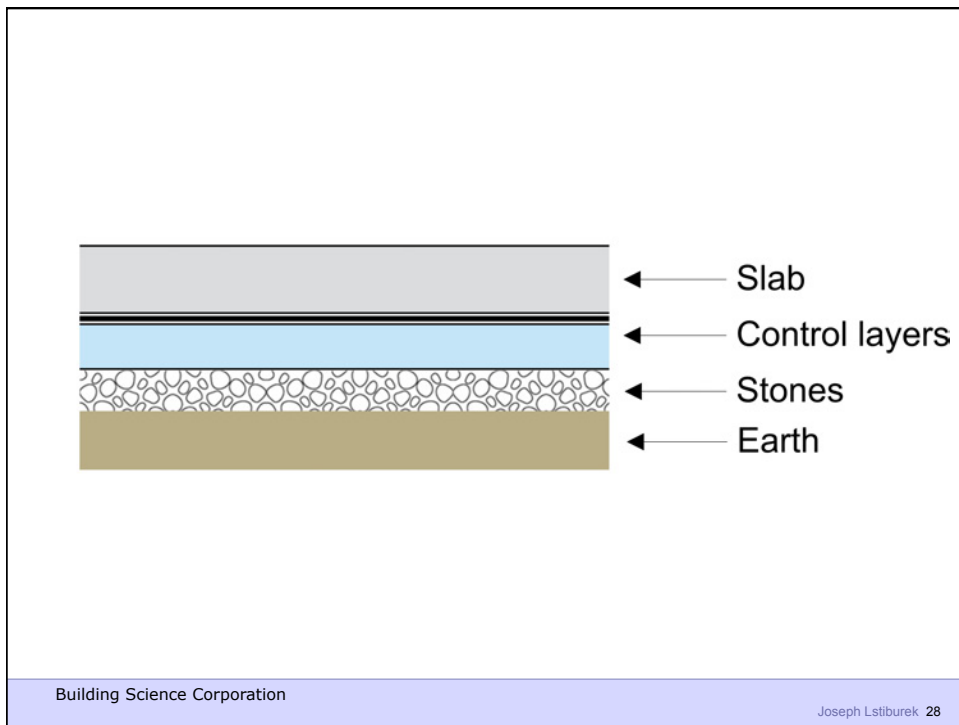
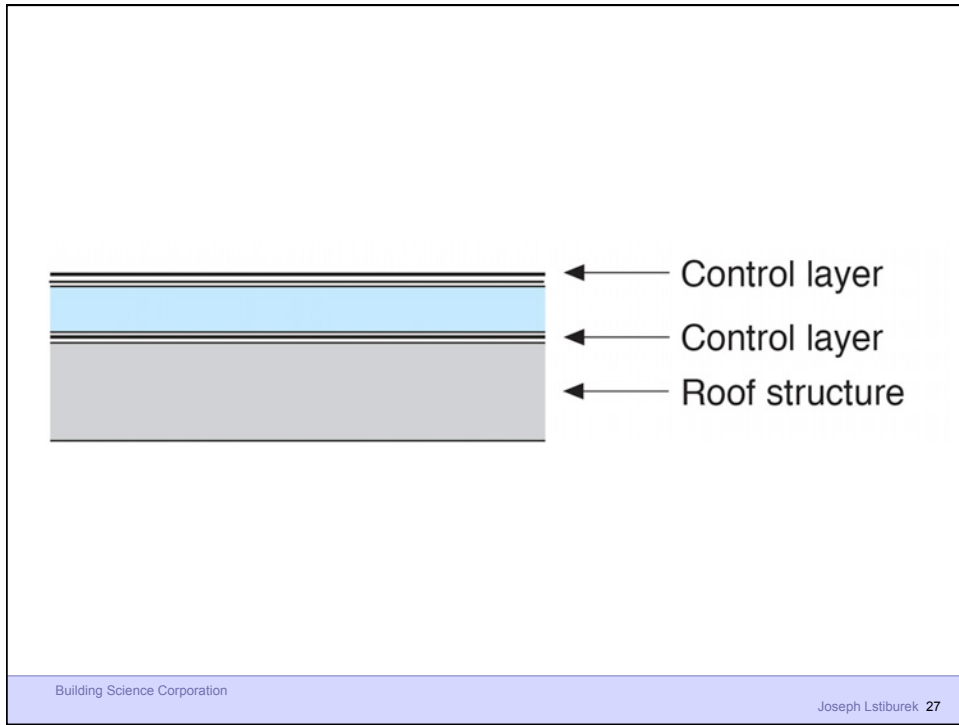

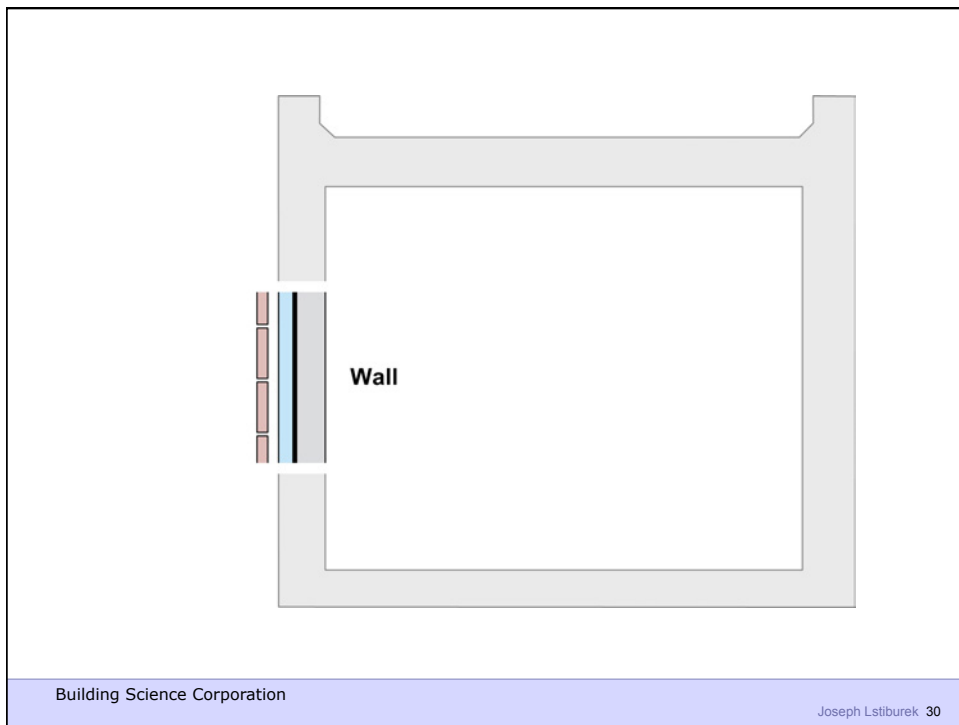
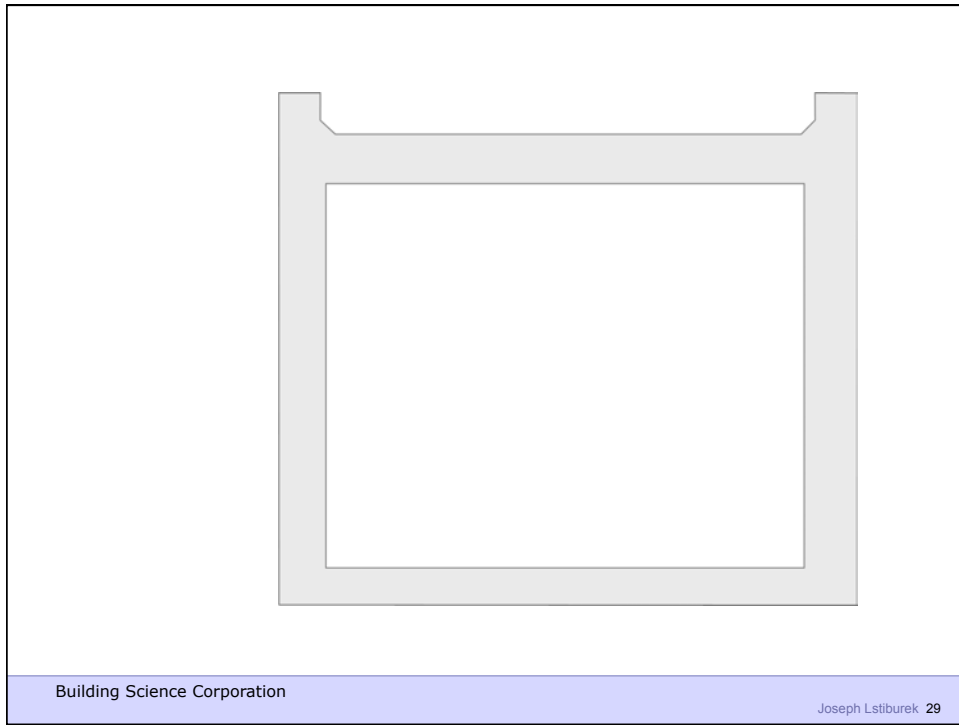

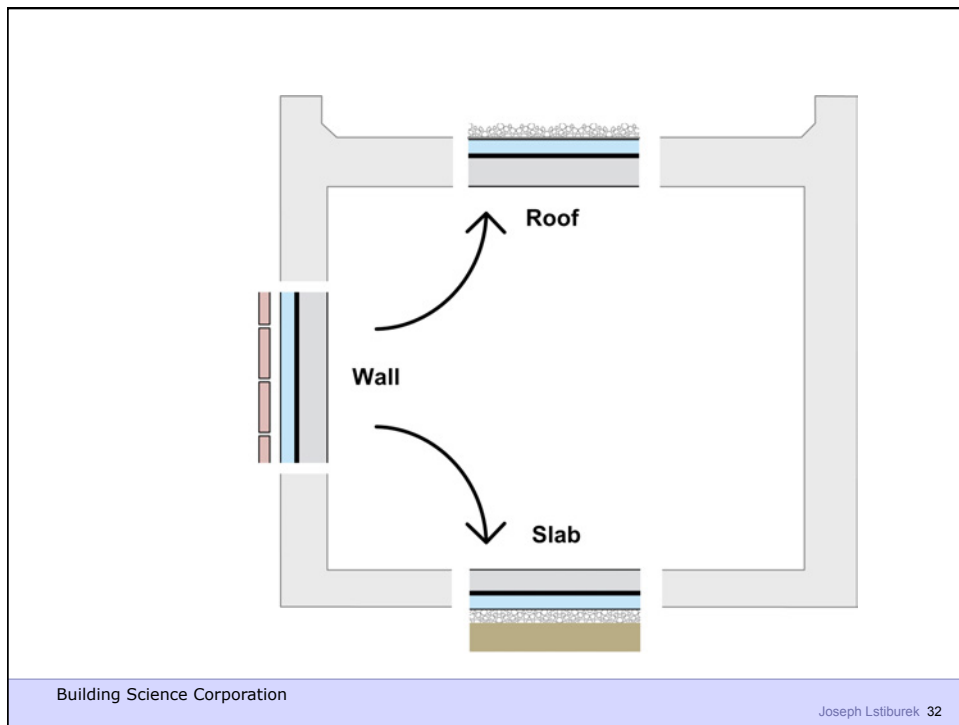
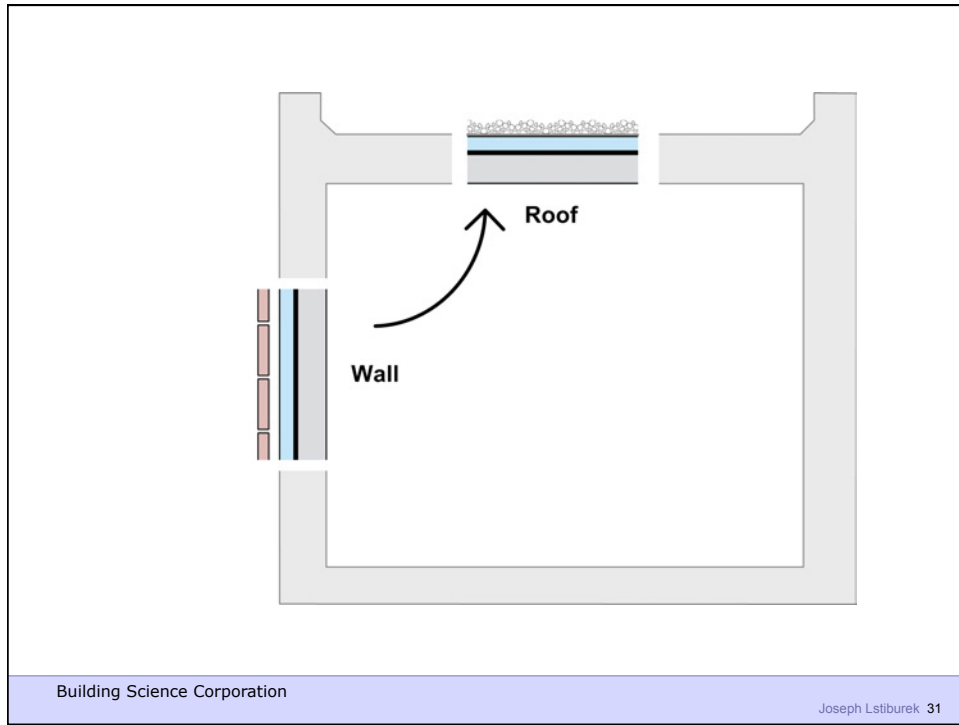

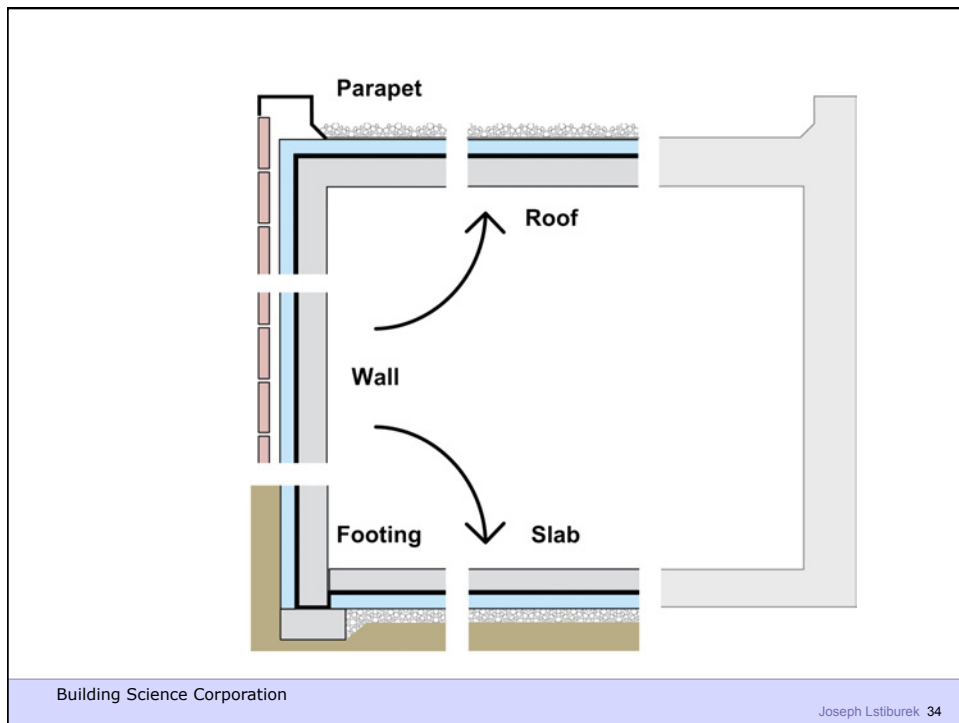
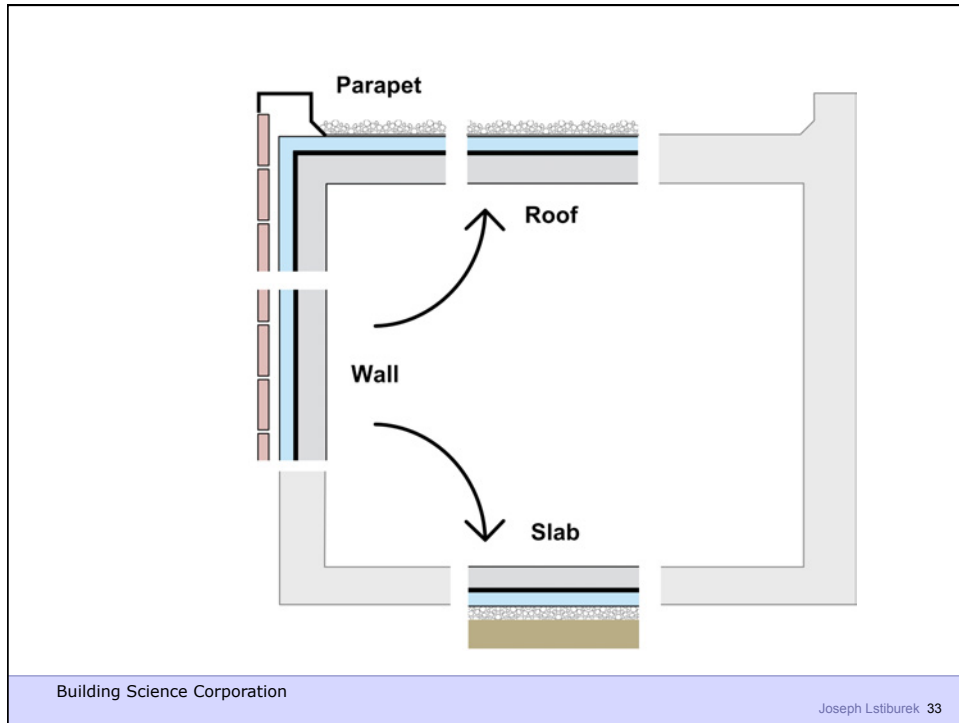

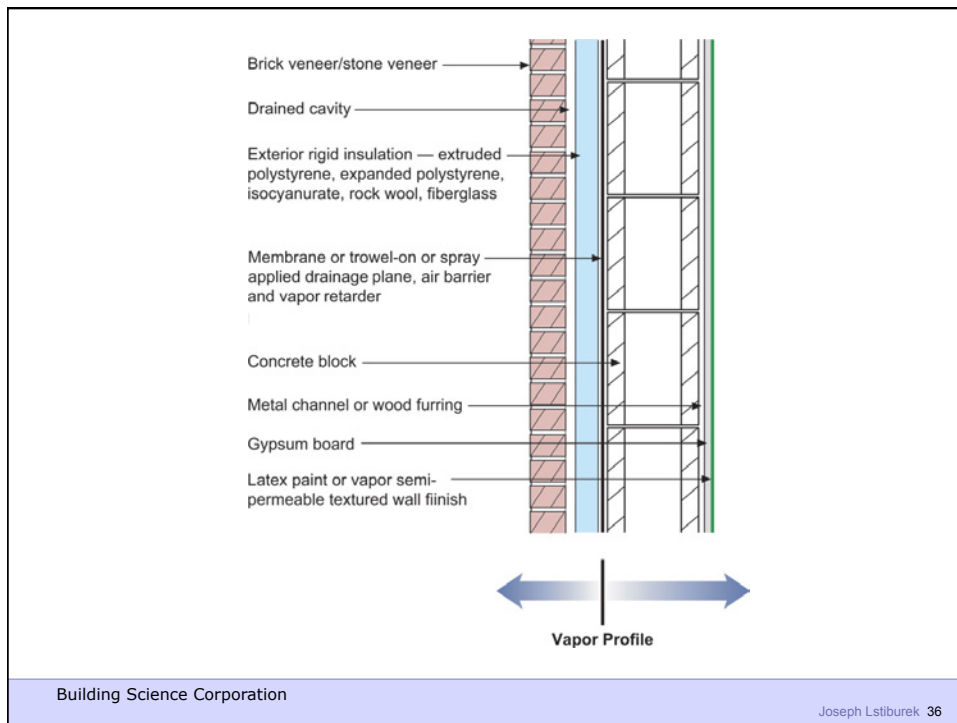
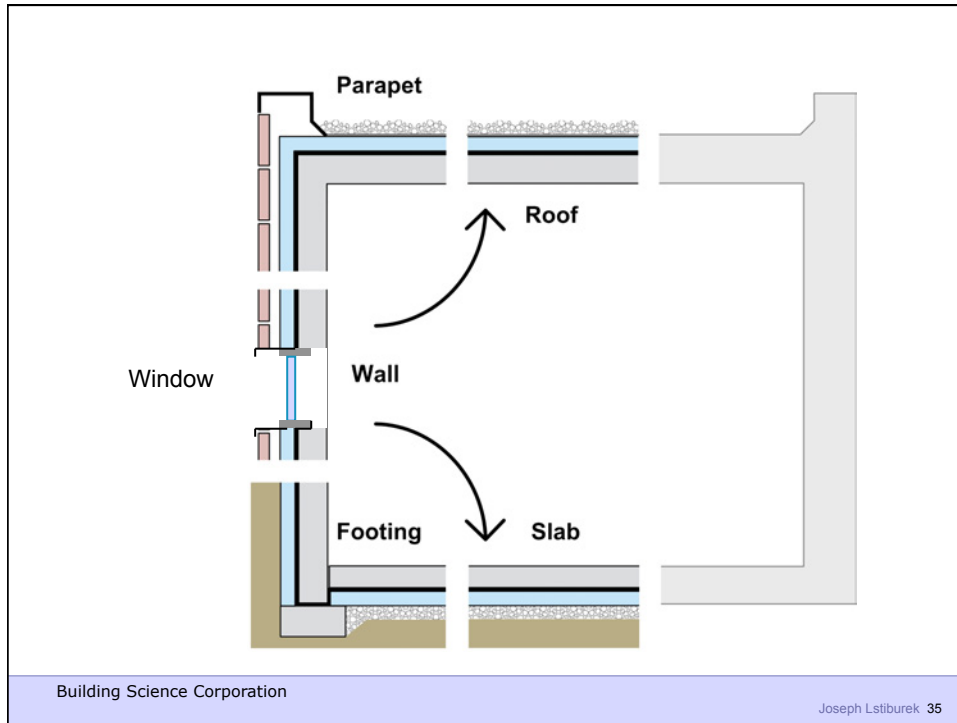

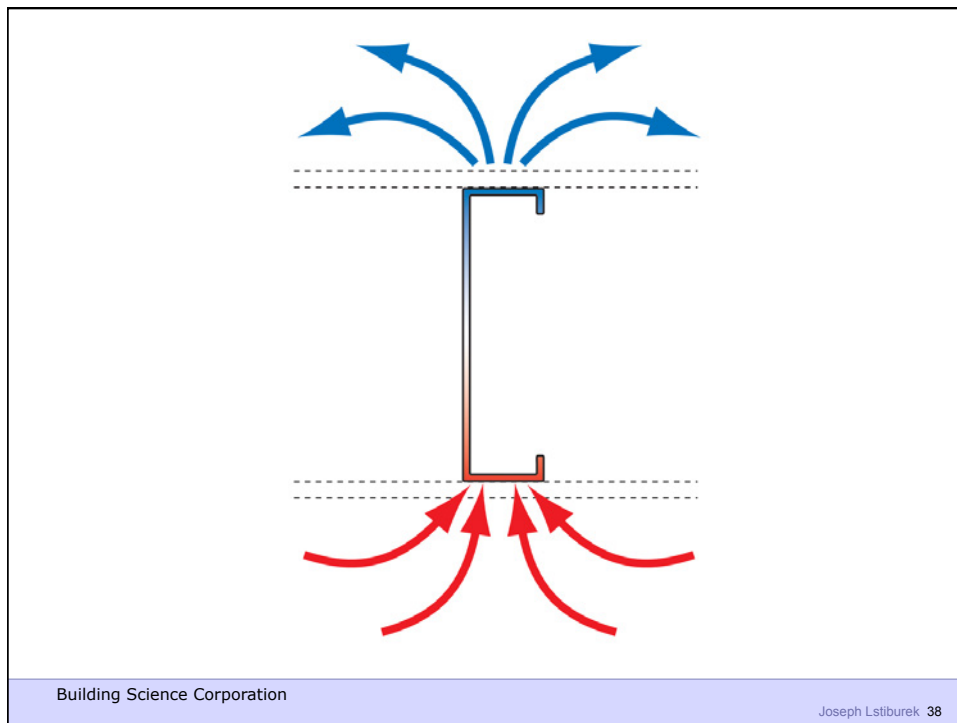
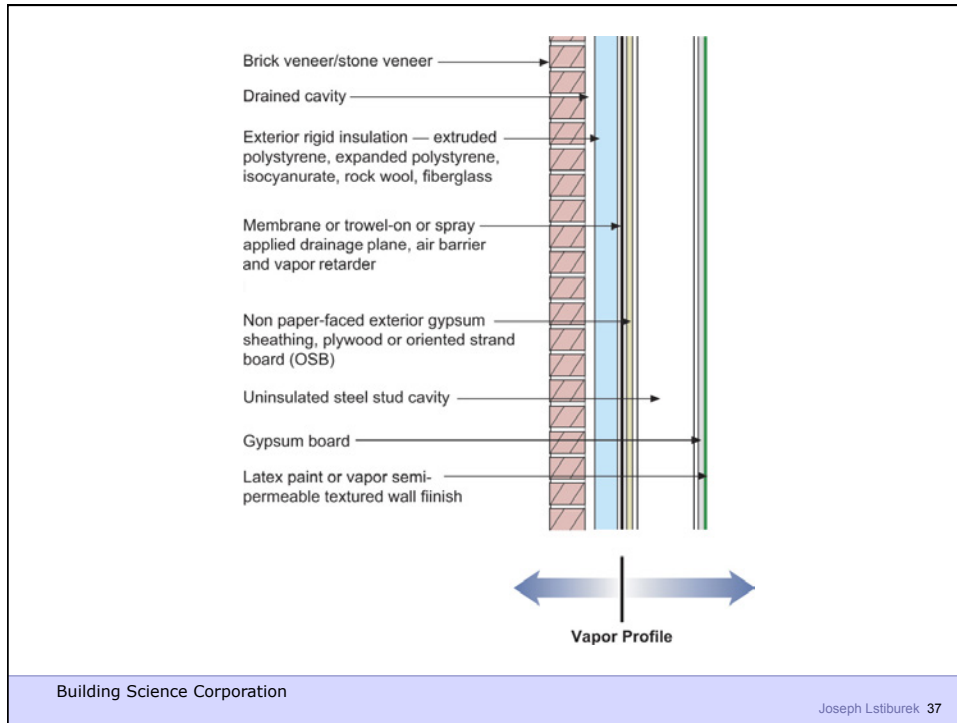

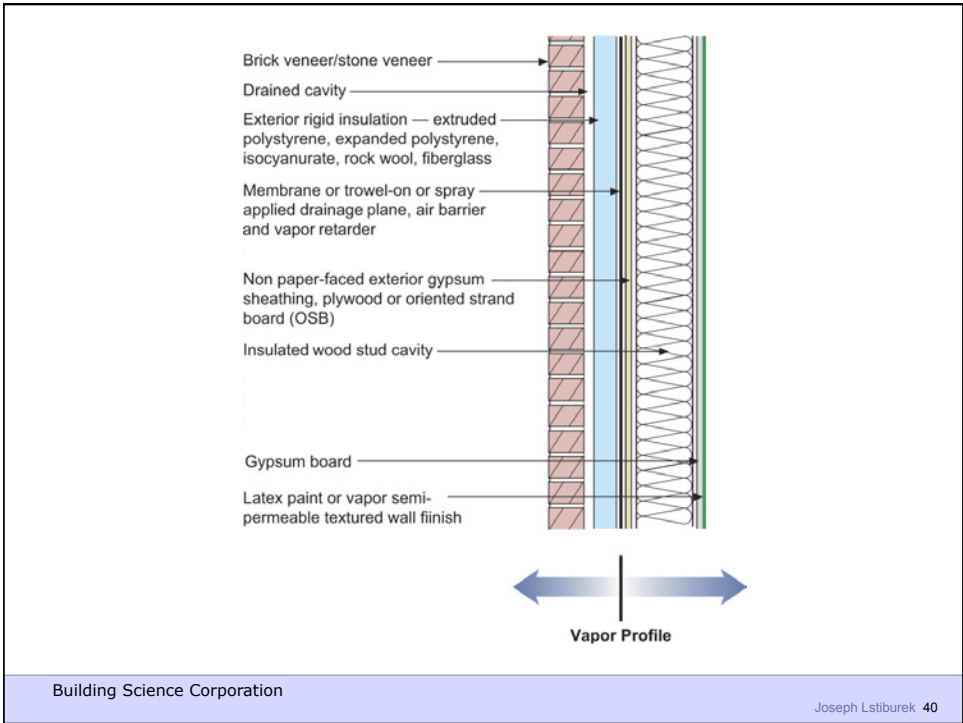

Commercial Enclosure: Simple Layers

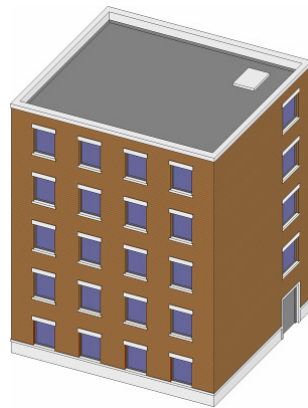

- Structure
- Rain/Air/Vapor
- Insulation
- Finish

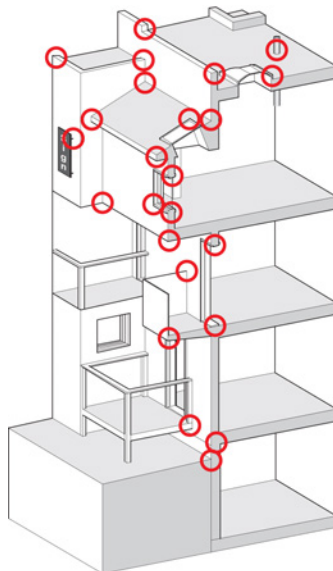





Building Science Corporation

Joseph Lstiburek 45



Building Science Corporation

Joseph Lstiburek 46



Building Science Corporation

Joseph Lstiburek 47



Building Science Corporation

Joseph Lstiburek 48

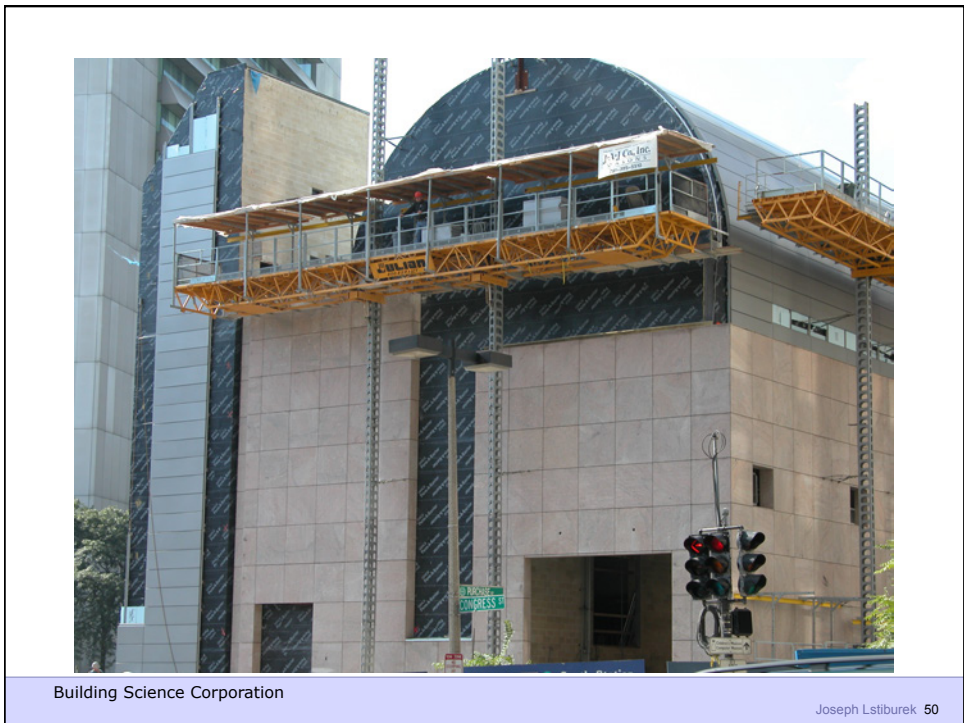

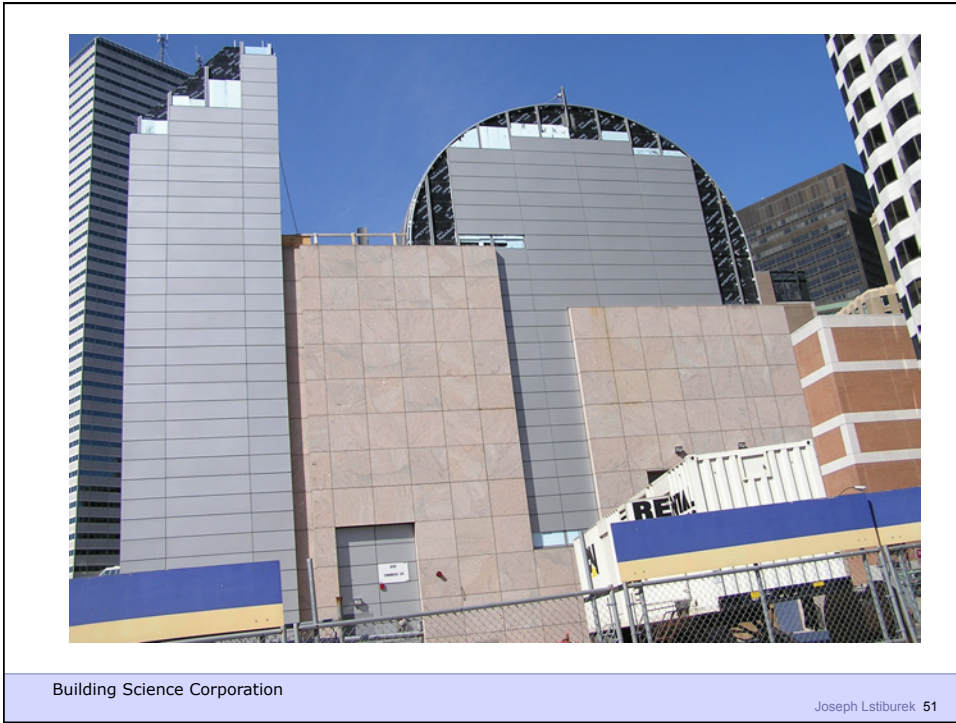

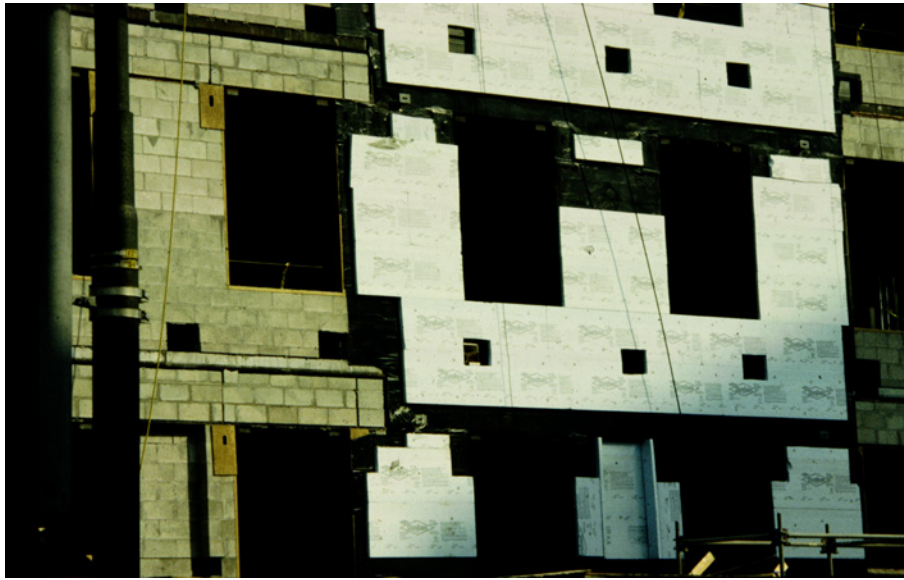

Building Science Corporation

Joseph Lstiburek 53



Building Science Corporation

Joseph Lstiburek 54



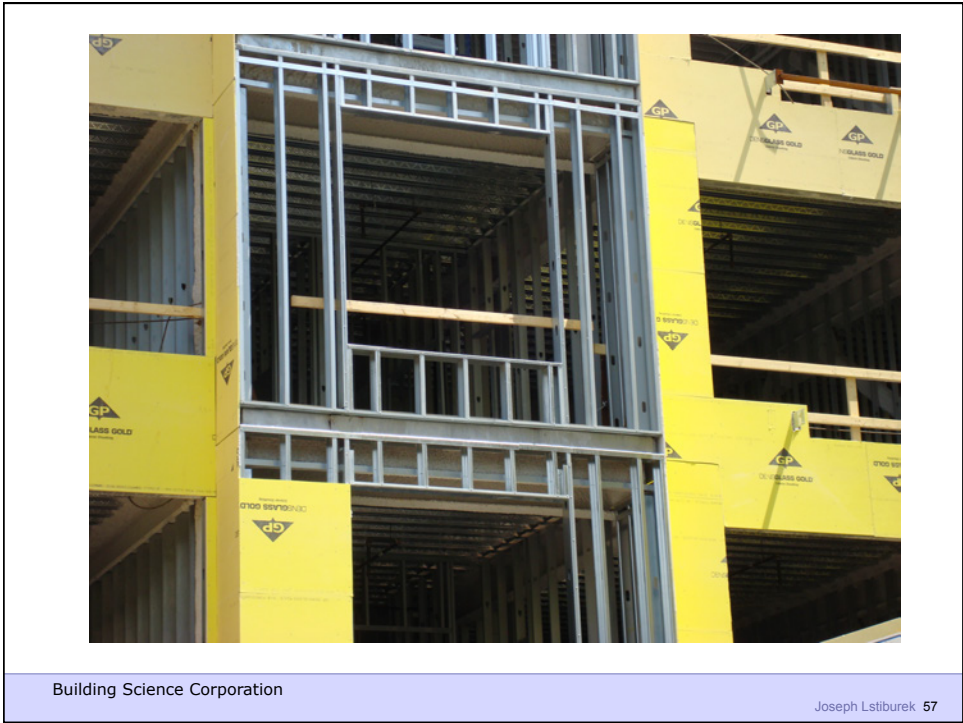





Building Science Corporation

Joseph Lstiburek 61



Building Science

Joseph Lstiburek 62







Building Science Corporation

Joseph Lstiburek 67



Building Science Corporation

Joseph Lstiburek 68

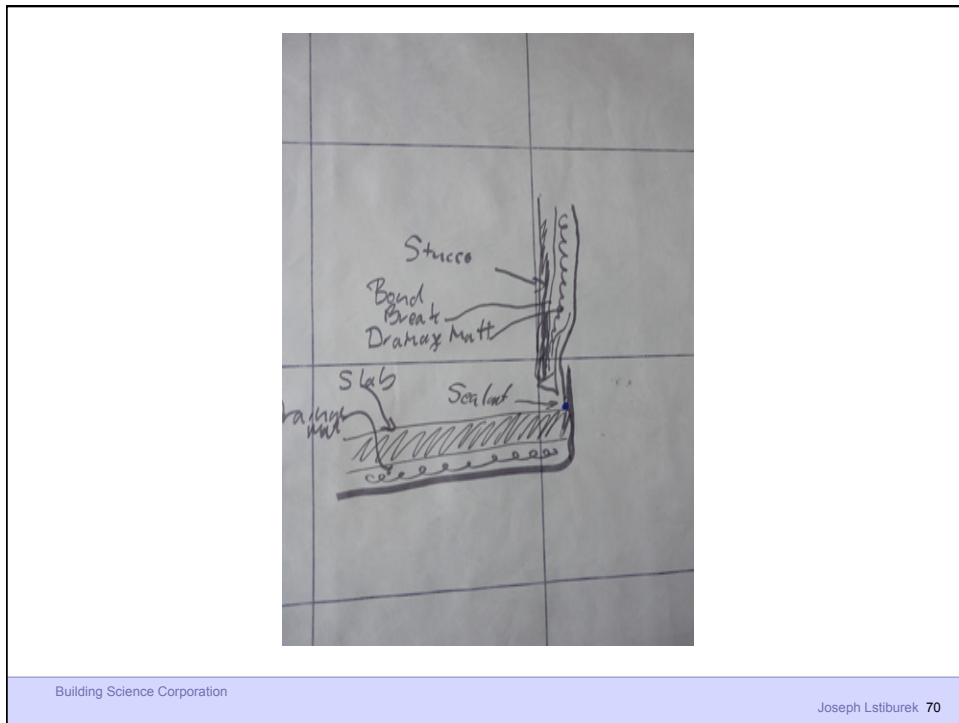
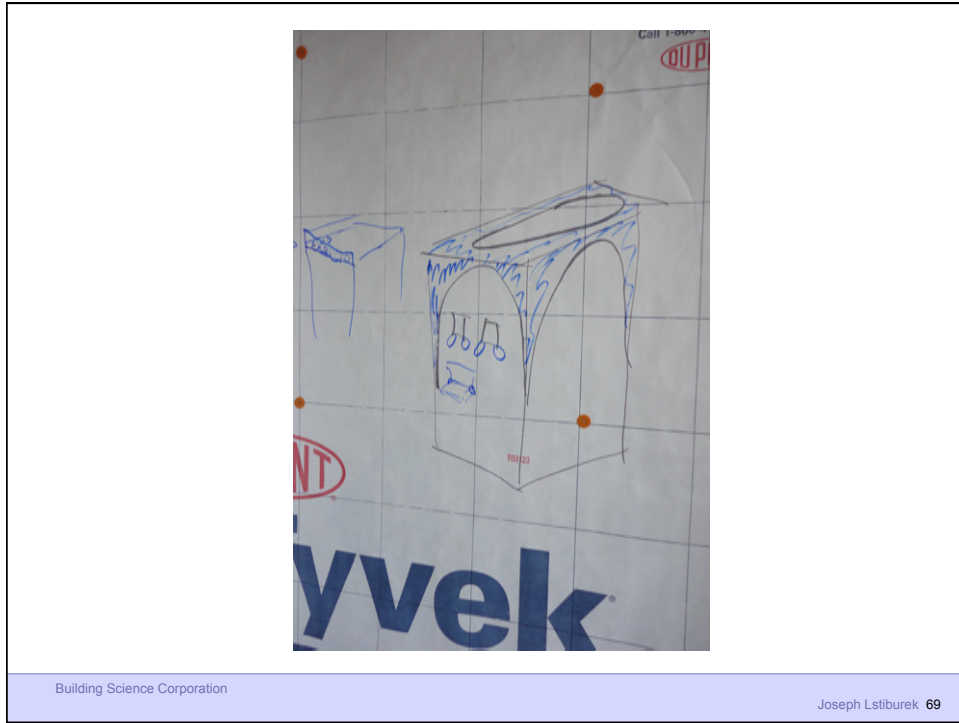





Building Science Corporation

Joseph Lstiburek 73



Building Science Corporation

Joseph Lstiburek 74







Building Science 2009

Joseph Lstiburek – HVAC 79



Building Science Corporation

Joseph Lstiburek 80

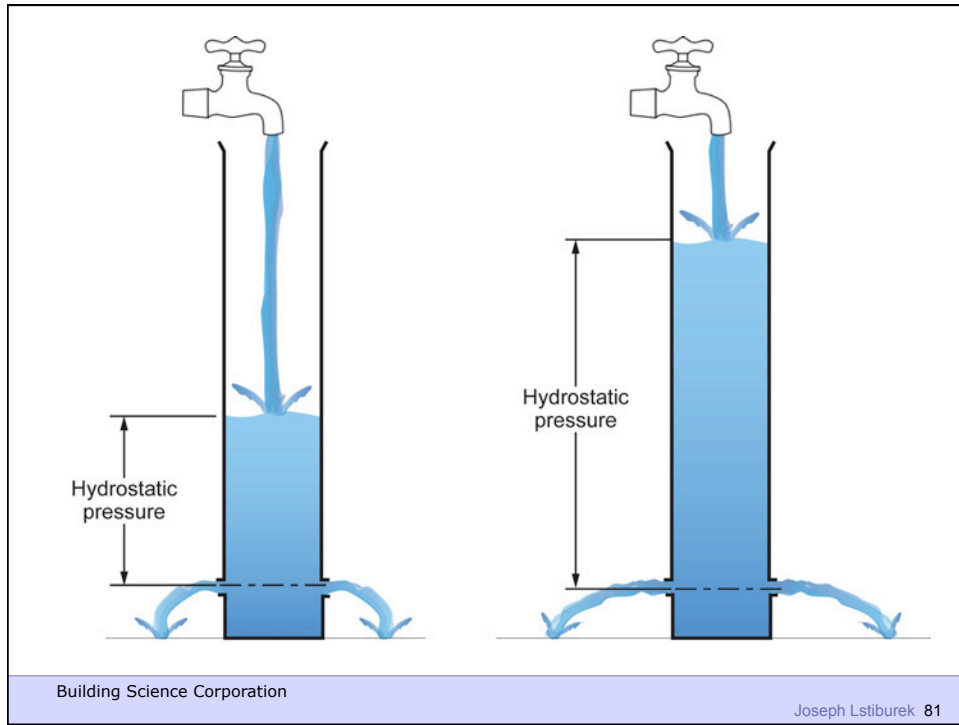

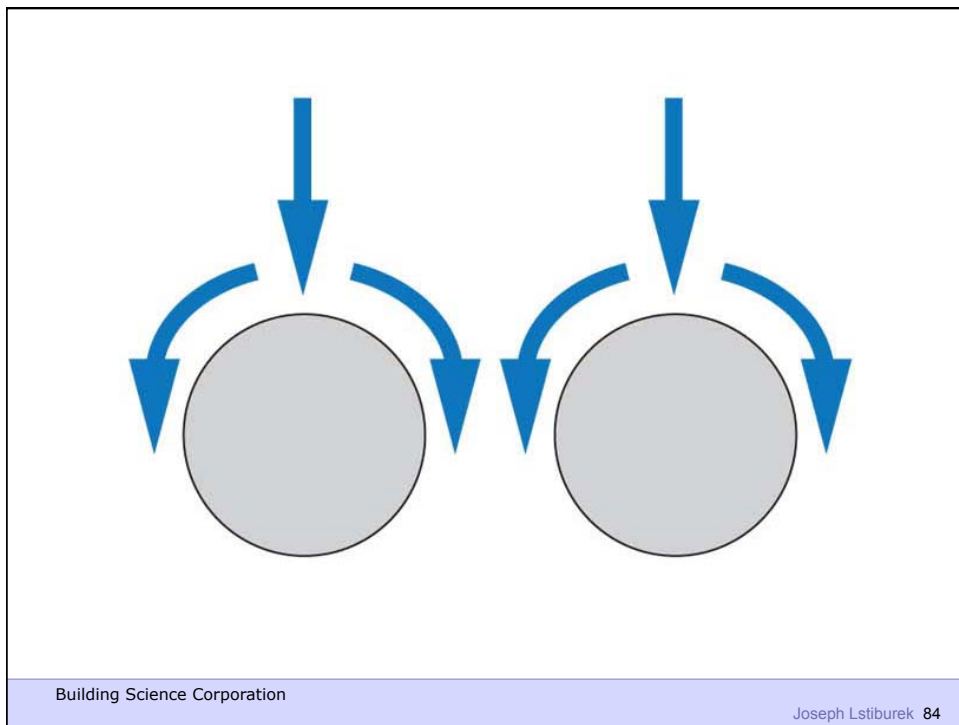
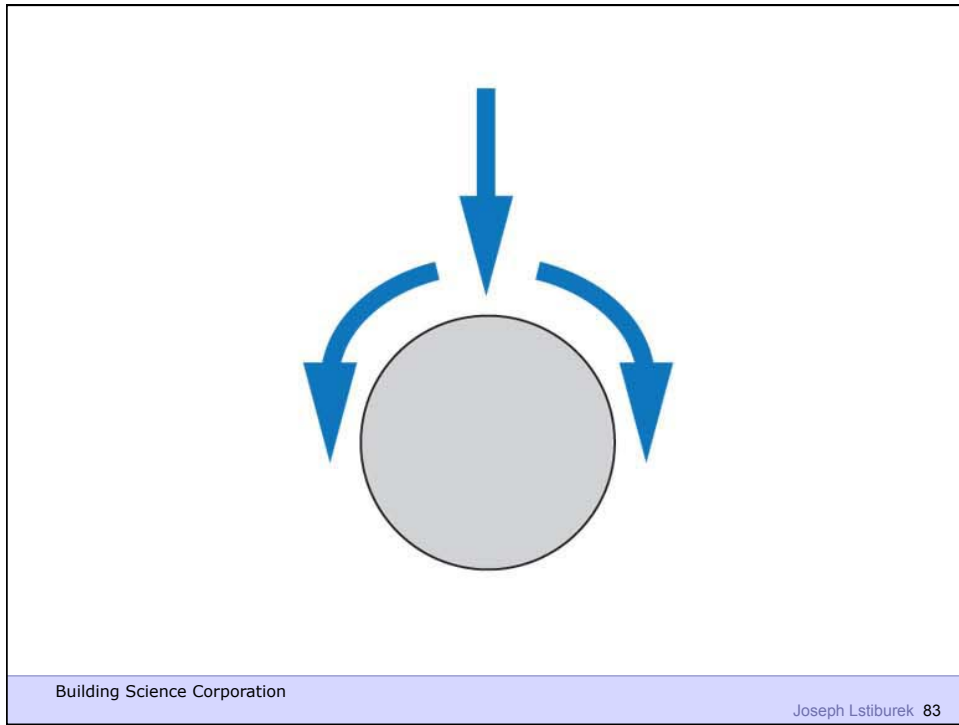

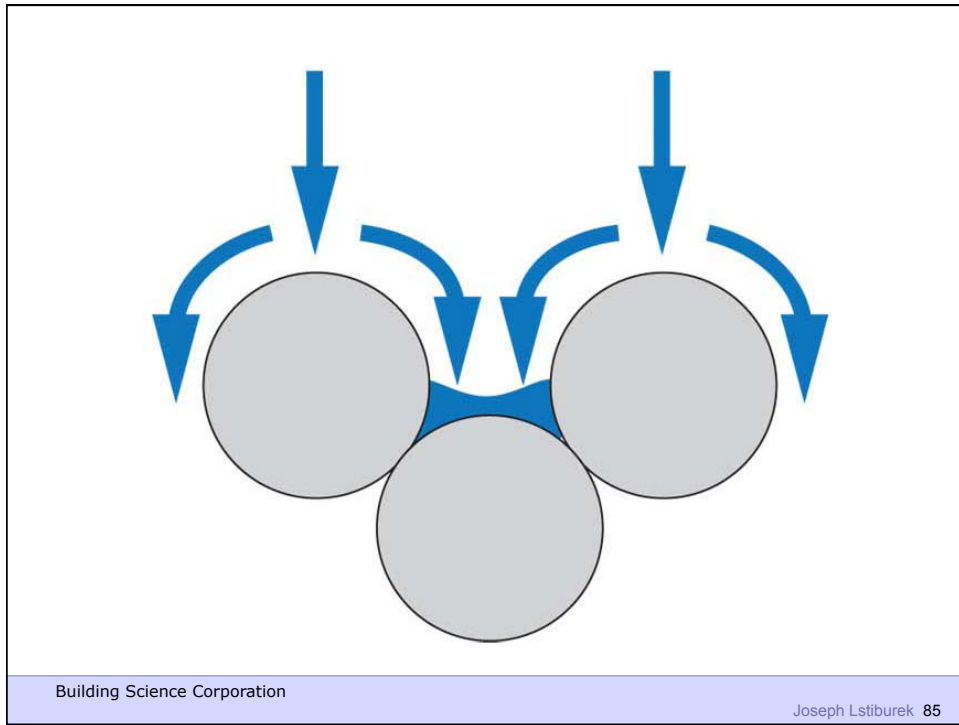

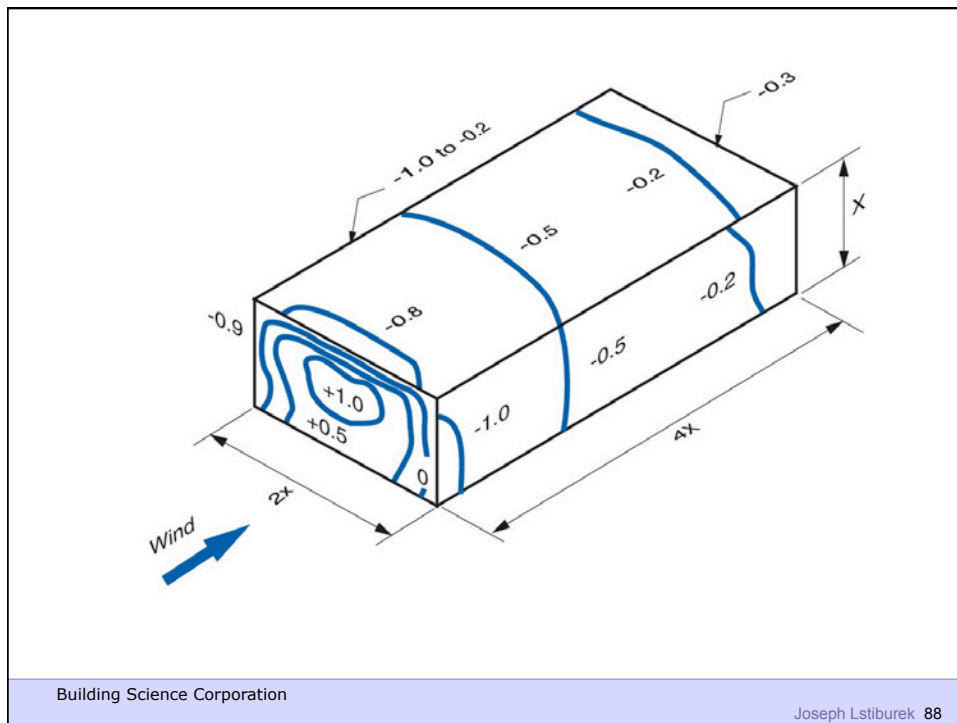
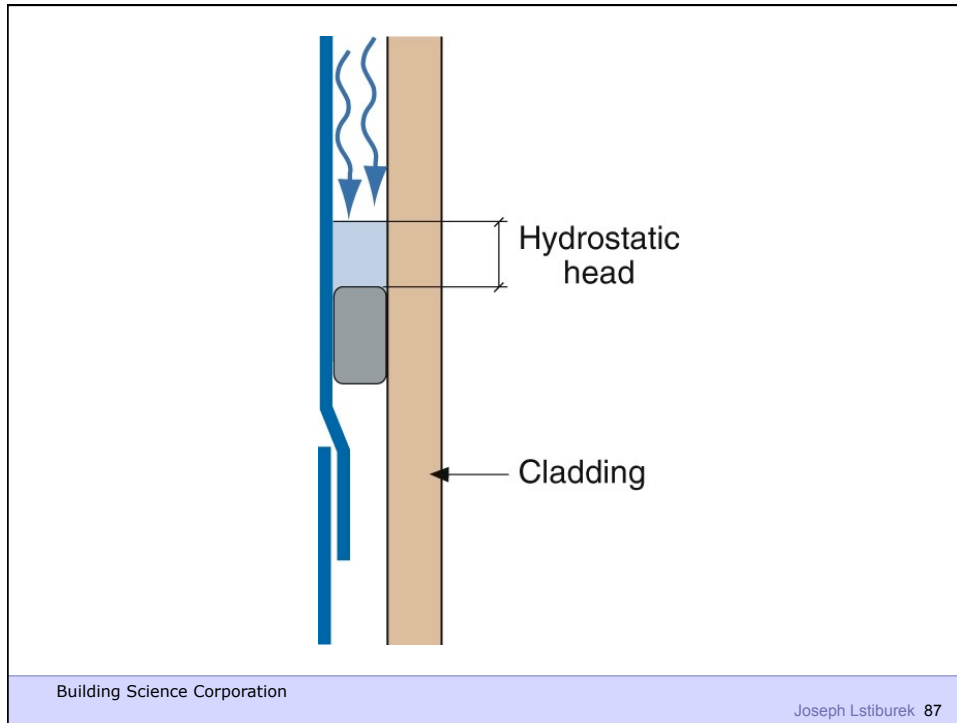

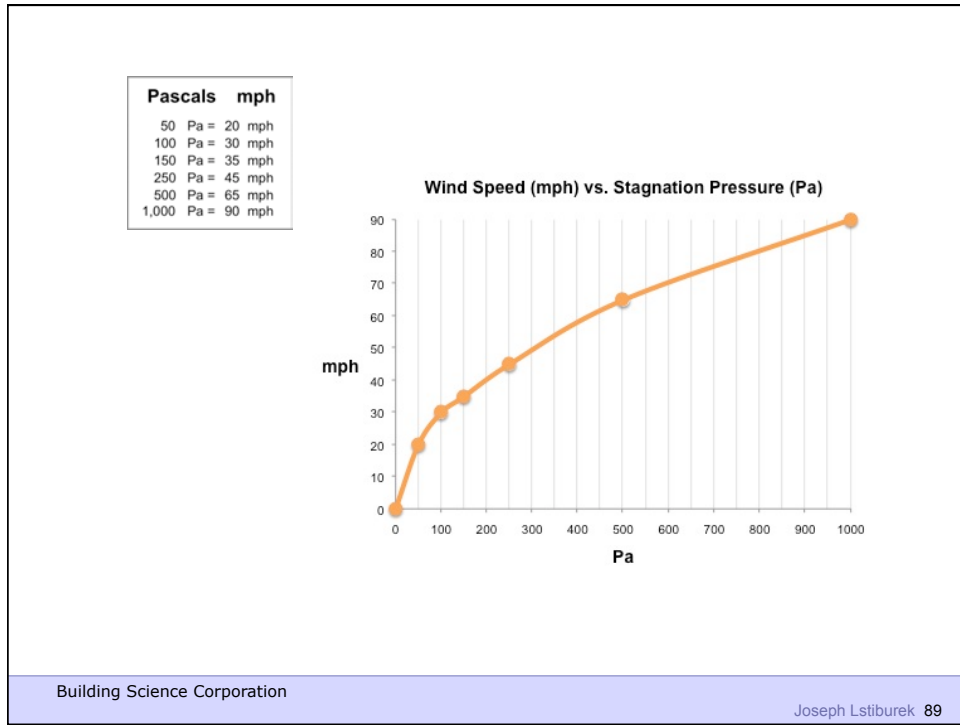



Building Science Corporation

Joseph Lstiburek – Rain Control 91

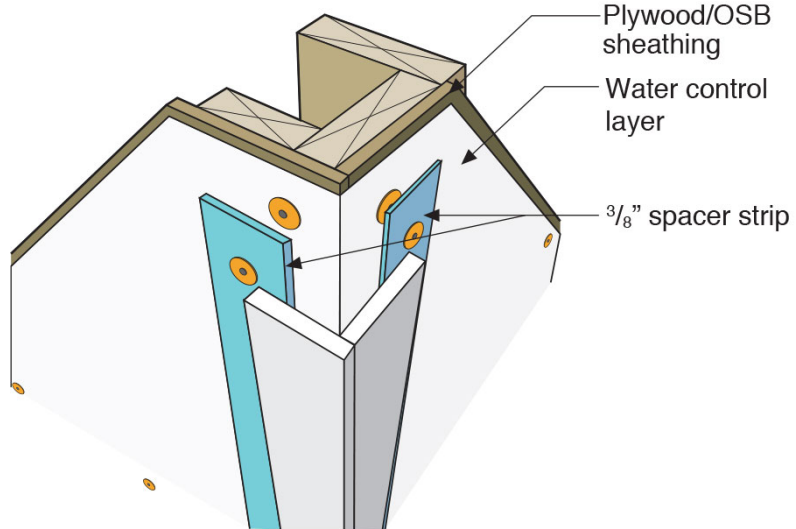

Building Science Corporation

Joseph Lstiburek 92

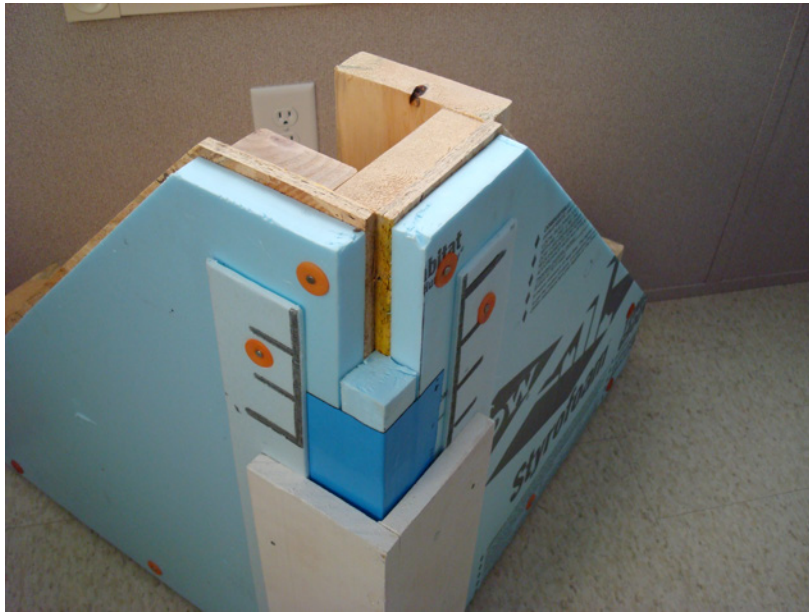

Building Science Corporation

Joseph Lstiburek 93



Building Science Corporation

Joseph Lstiburek 94

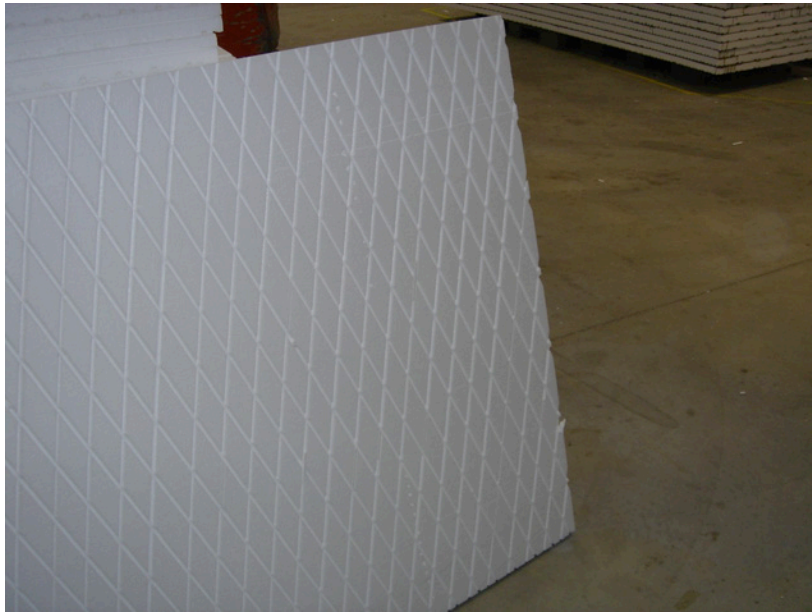

Building Science Corporation

Joseph Lstiburek 95



Building Science Corporation

Joseph Lstiburek 96



Building Science Corporation

Joseph Lstiburek 97

Rain enters cup
due to momentum
("kinetic energy")

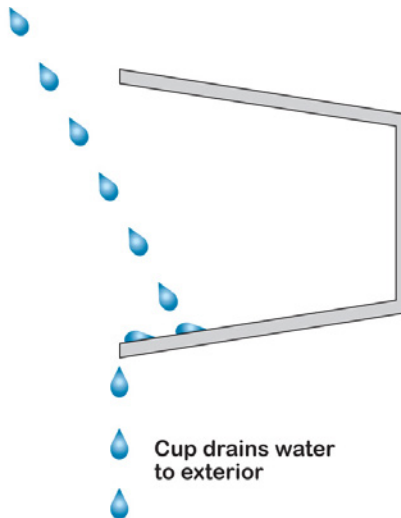

Cup drains water
to exterior

Building Science Corporation
2011

Joseph Lstiburek 98

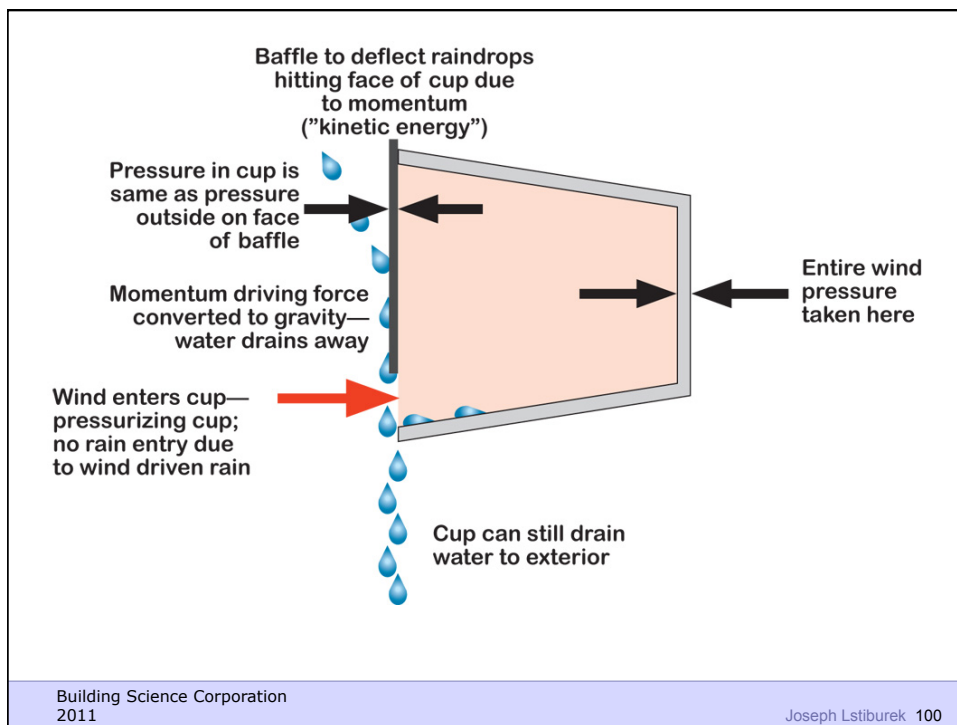
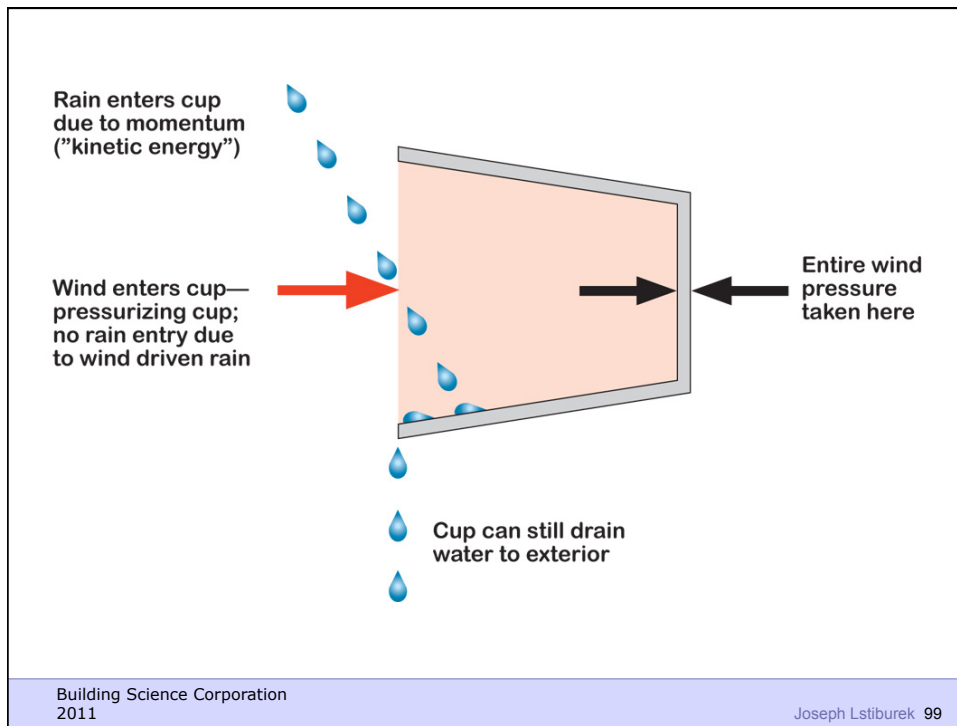

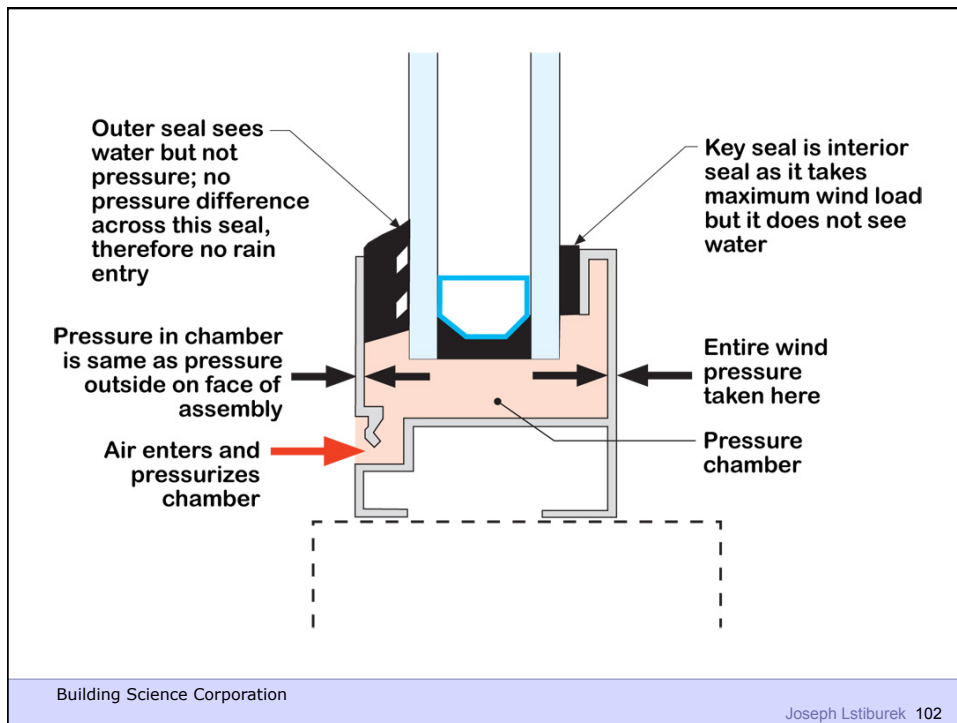
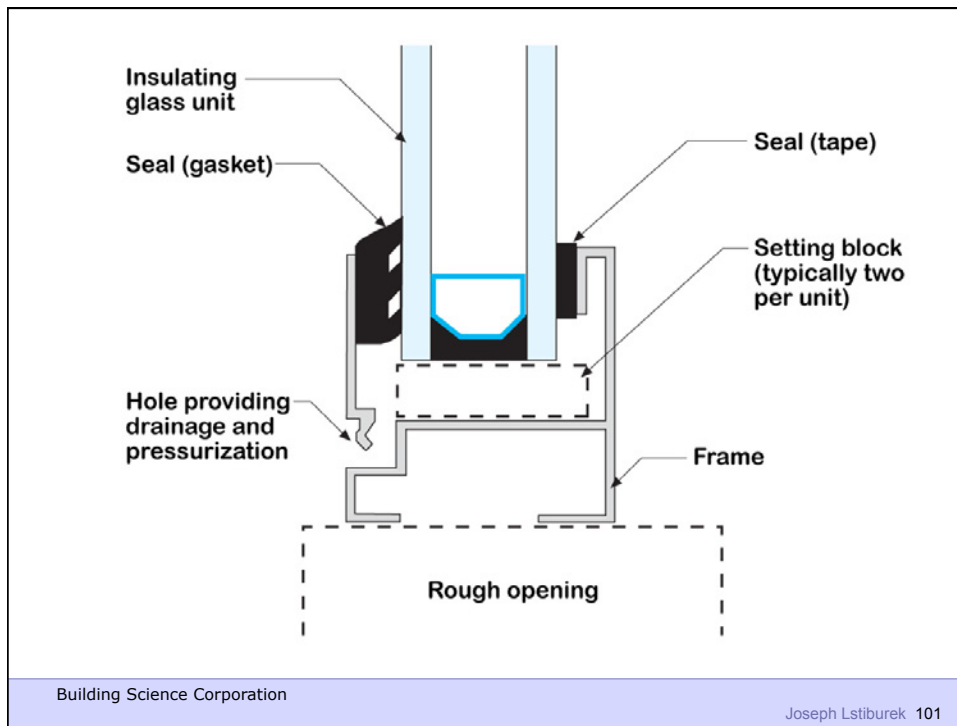

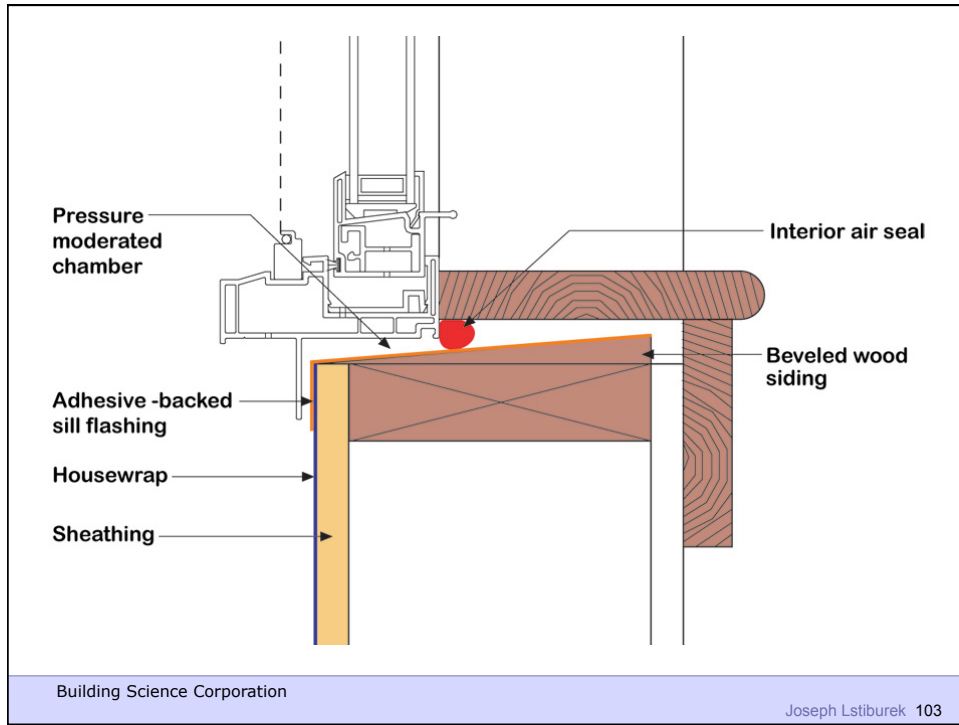



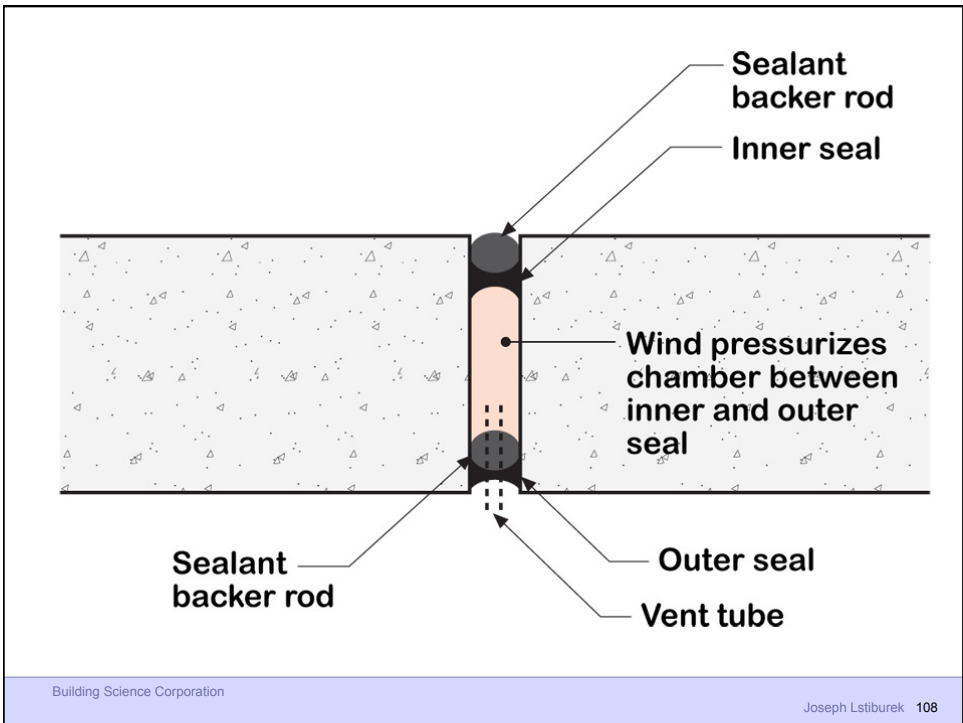
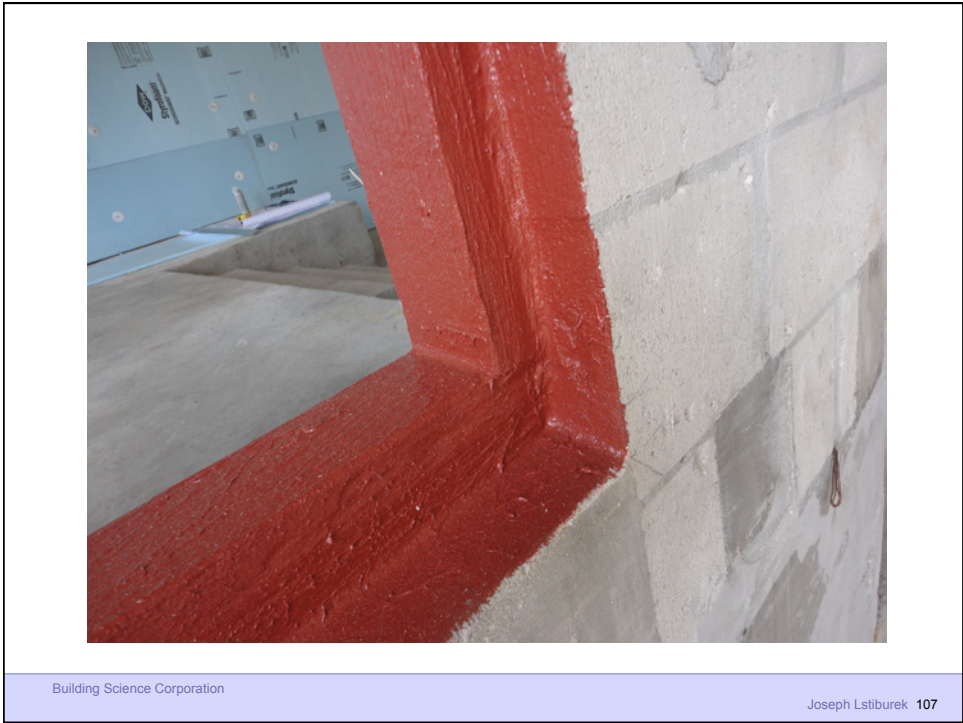

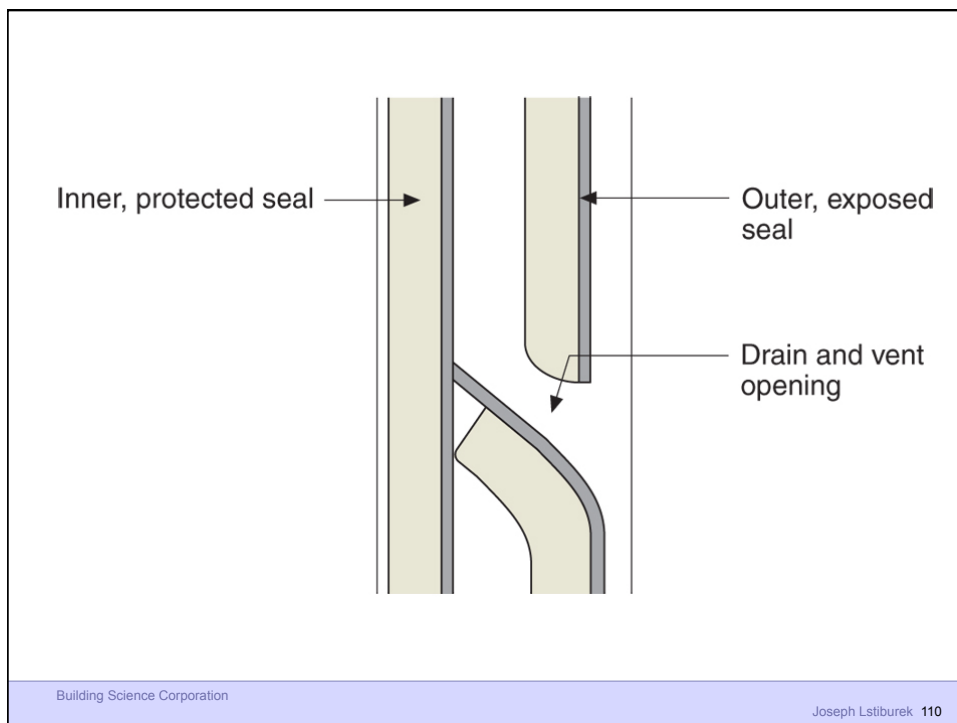
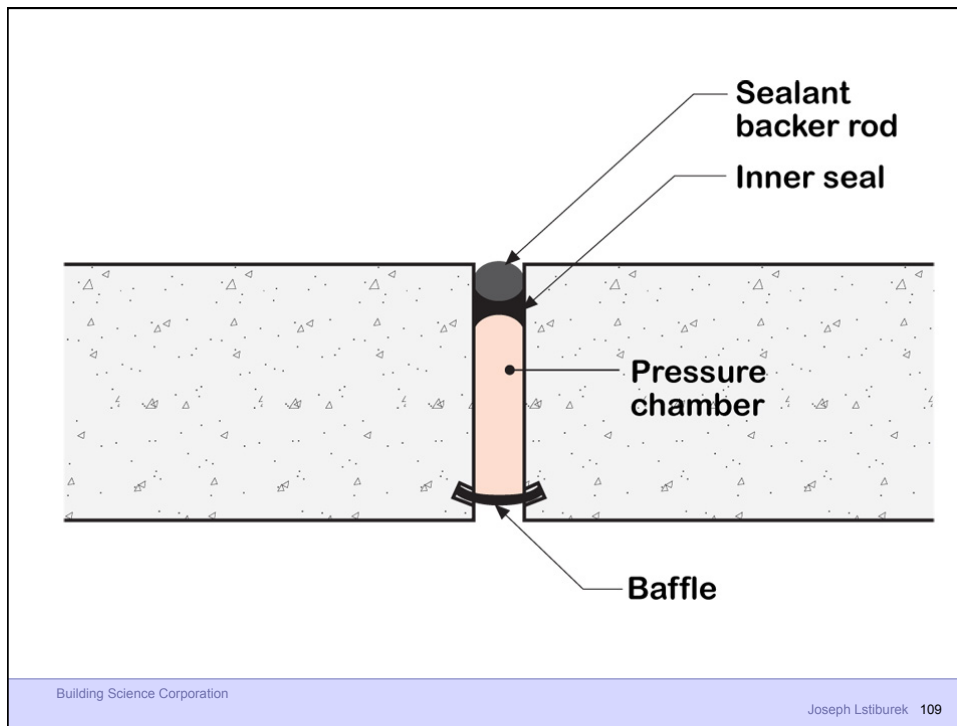

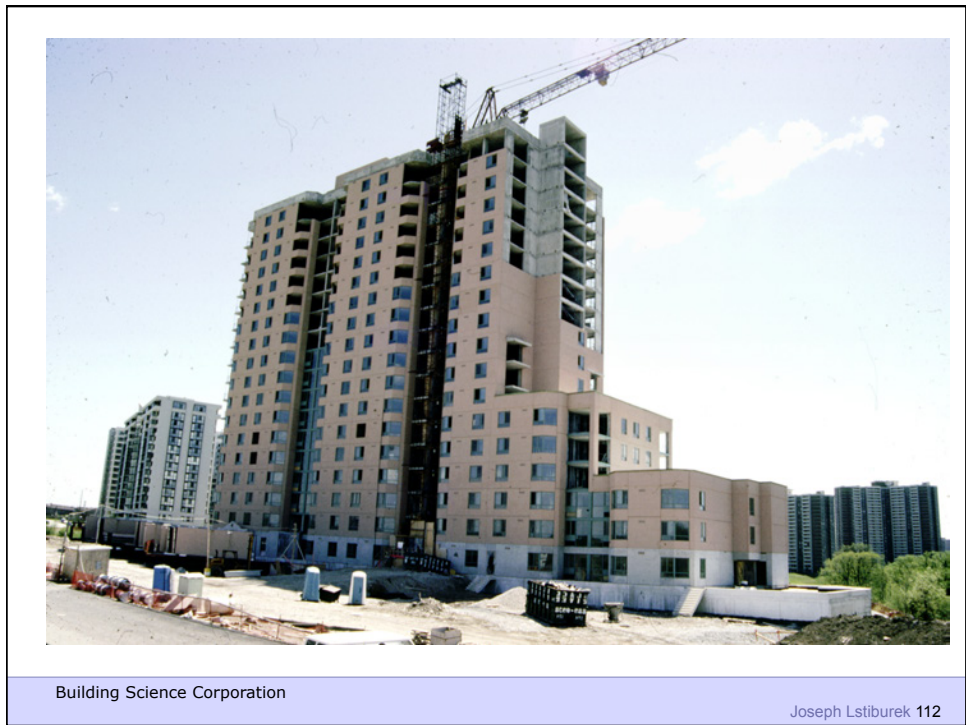
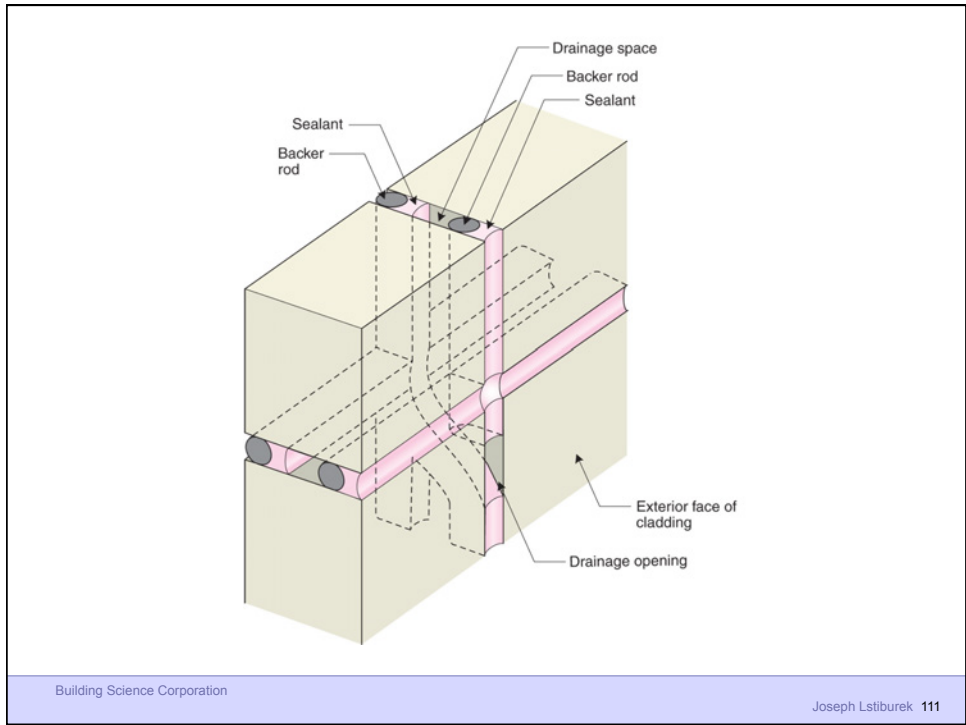



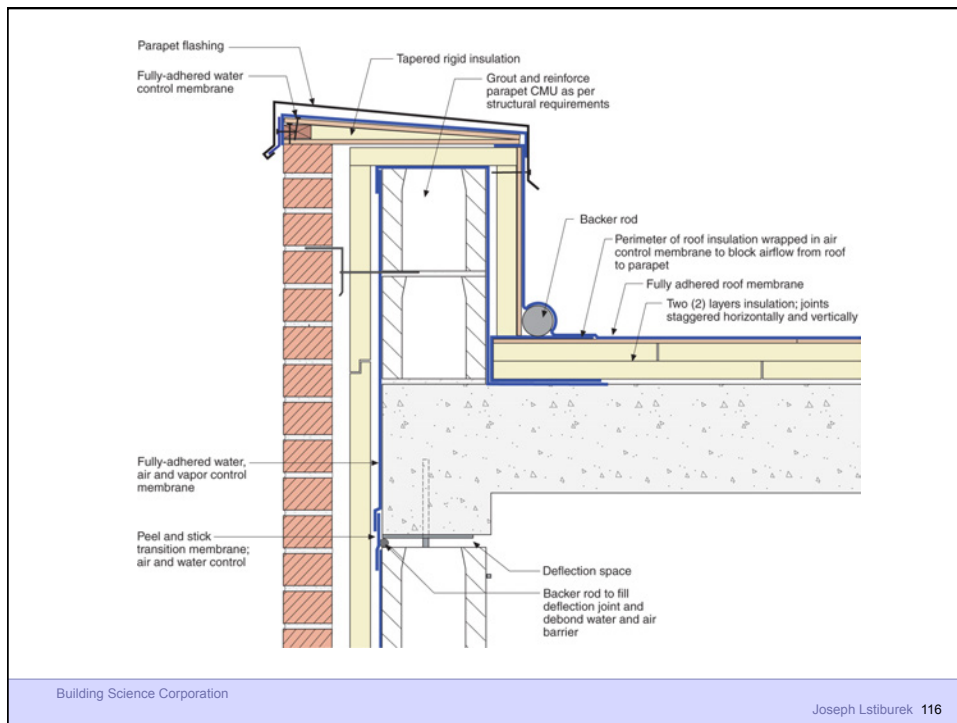
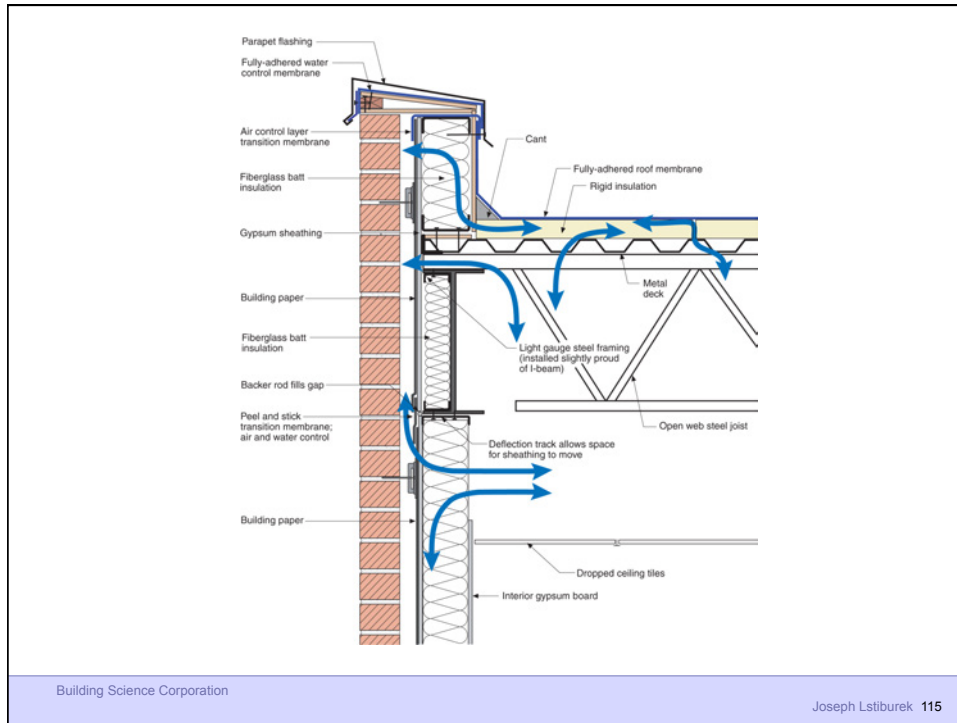

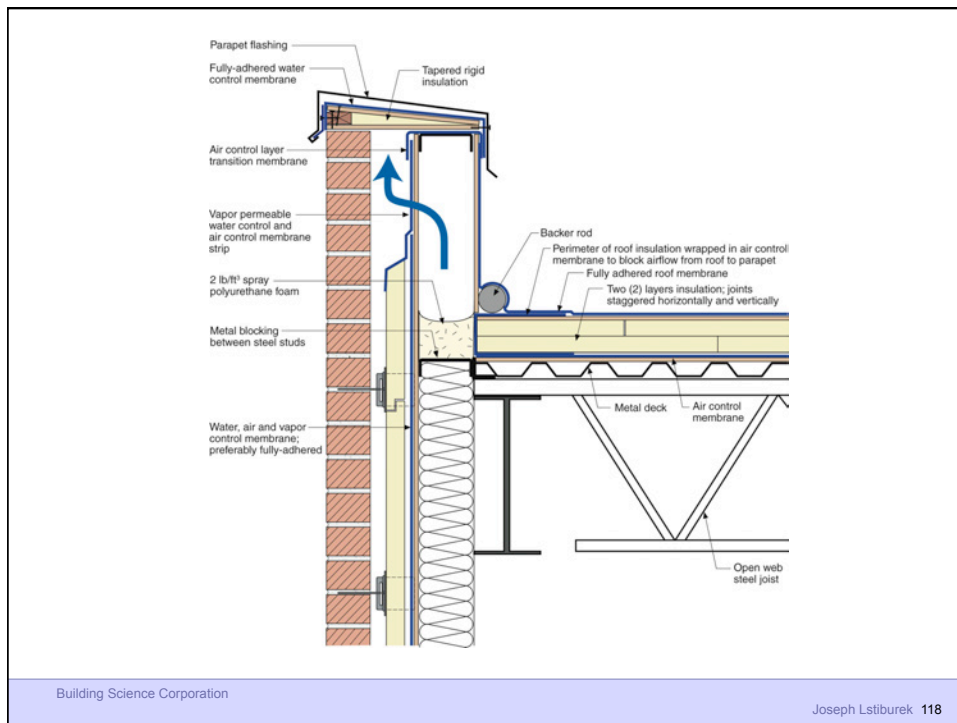
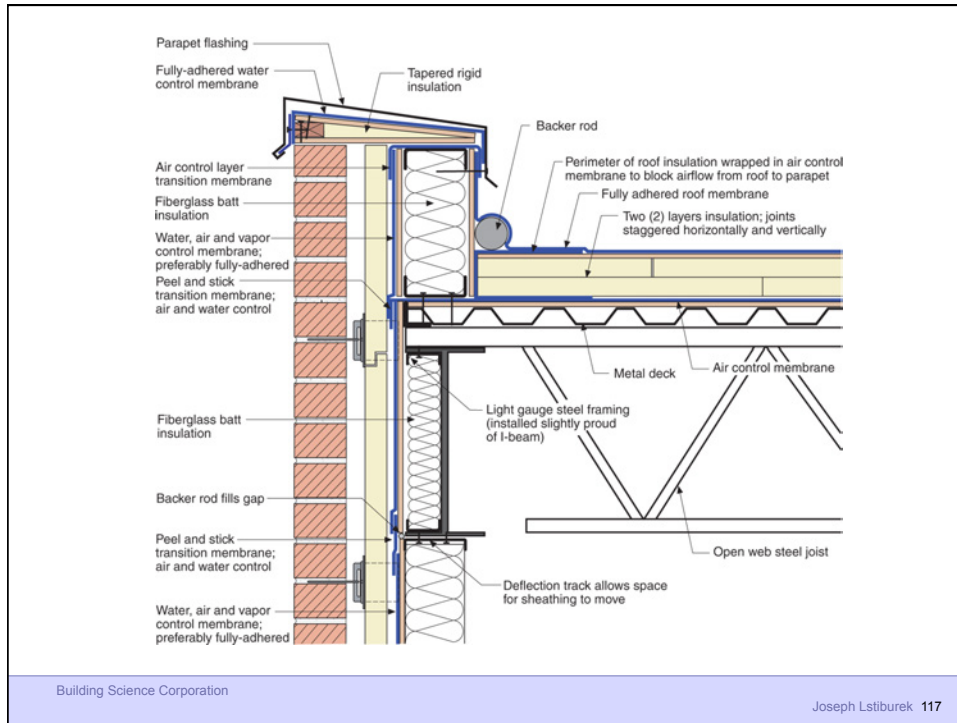

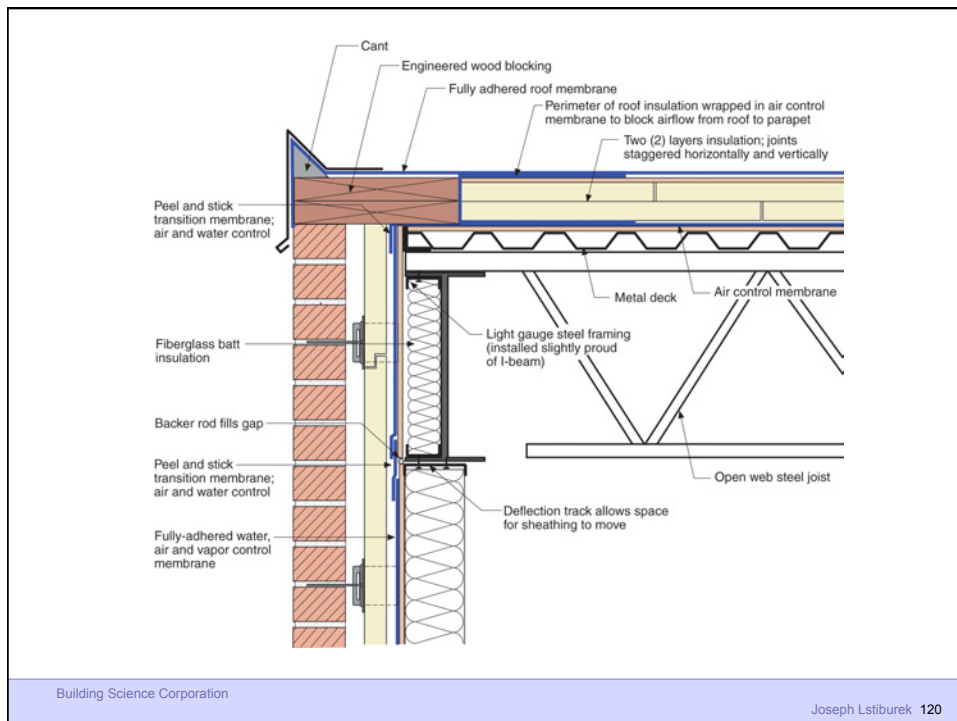
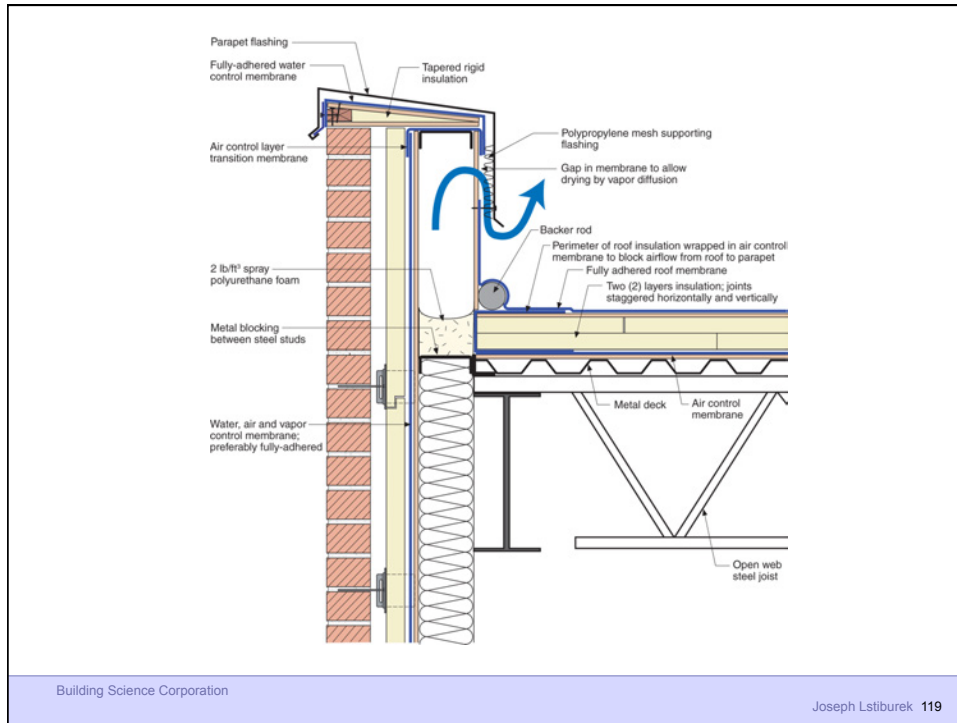

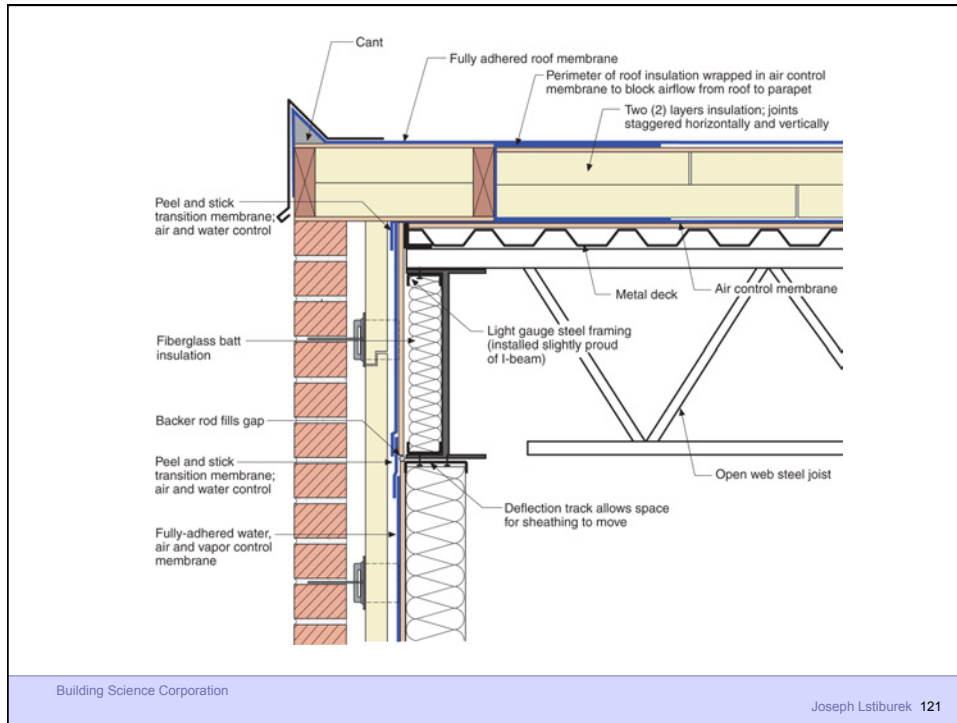

It's a Case of Black or White

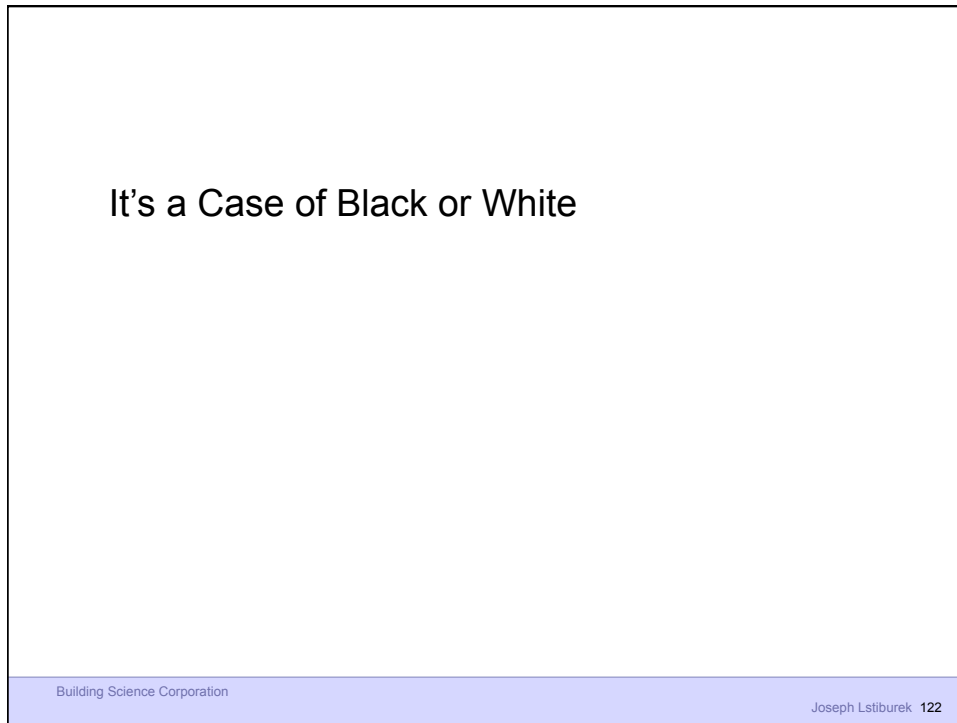

It's a Case of Black or White Arrhenius

Building Science Corporation

Joseph Lstiburek 123

It's a Case of Black or White
Arrhenius
Every 10 degrees C – double the “badness”

Building Science Corporation

Joseph Lstiburek 124

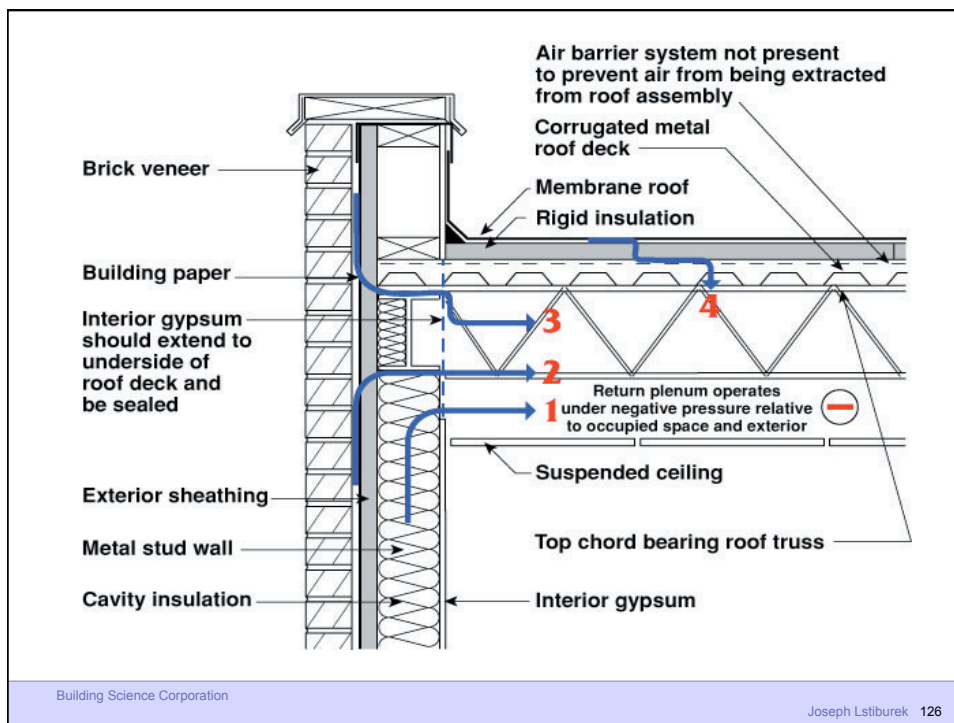
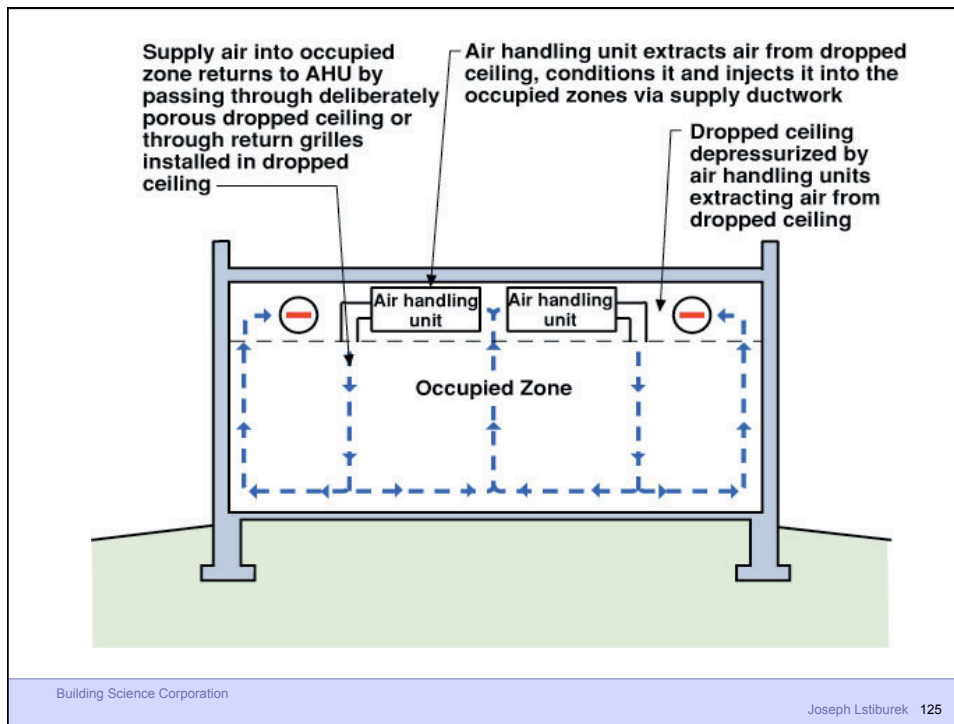



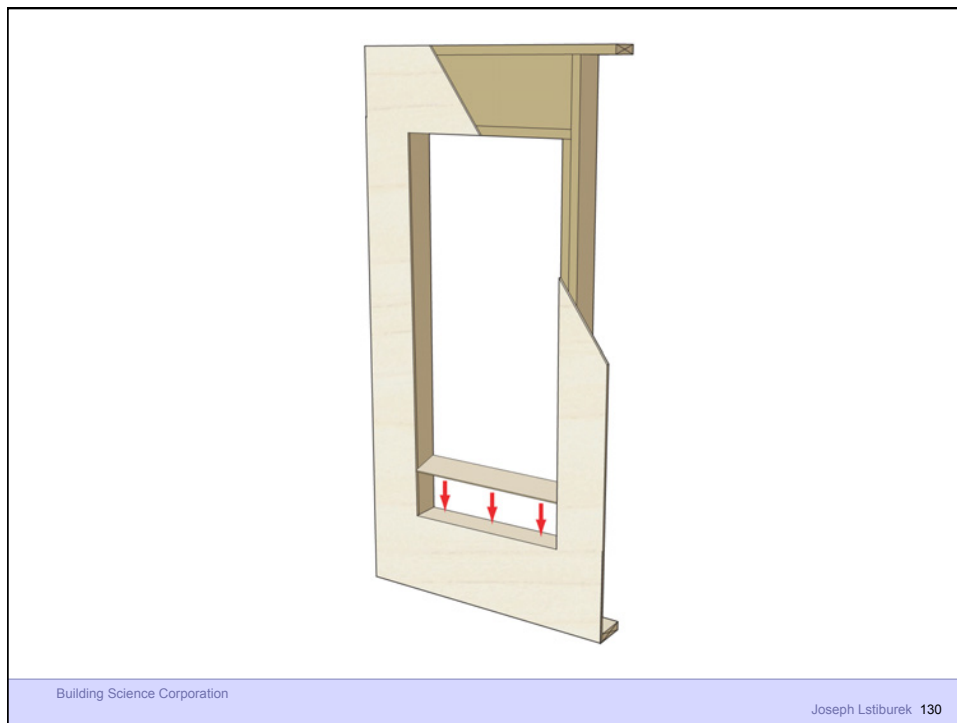
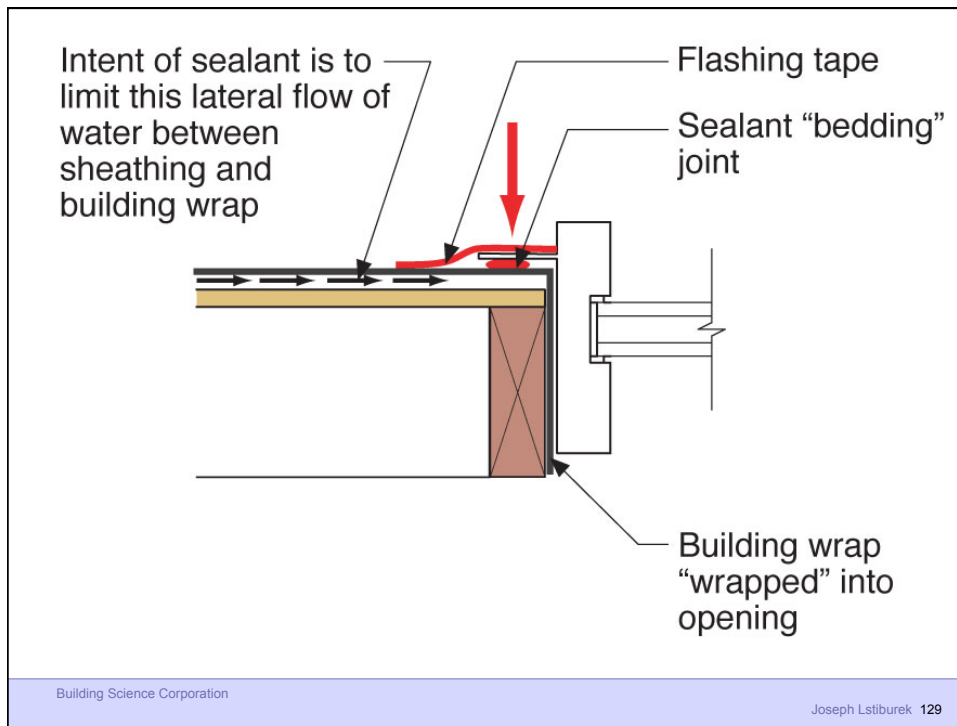

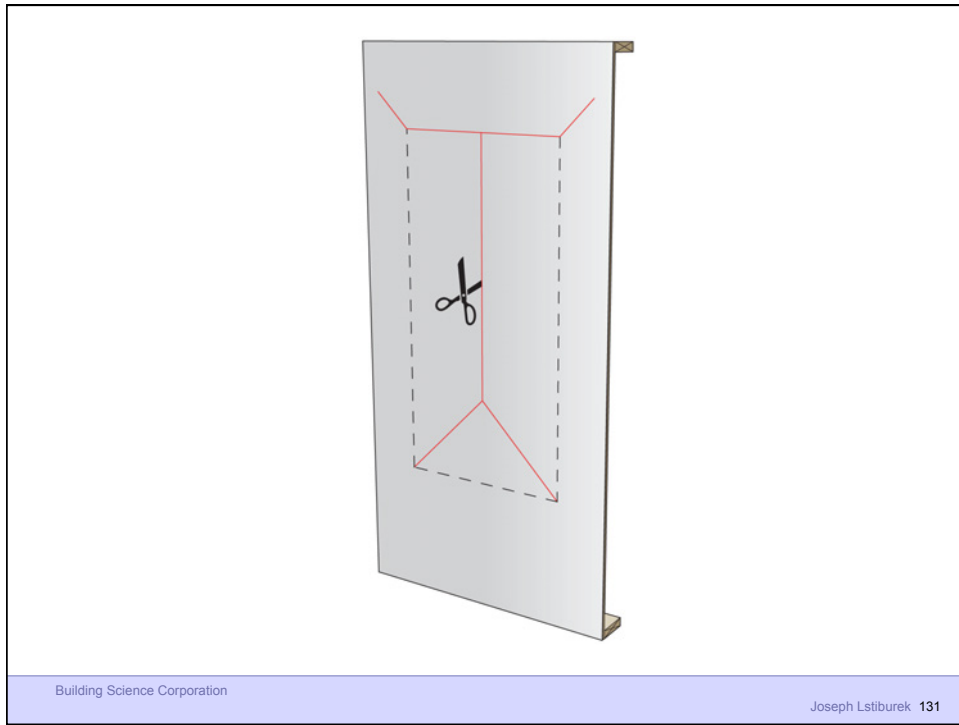

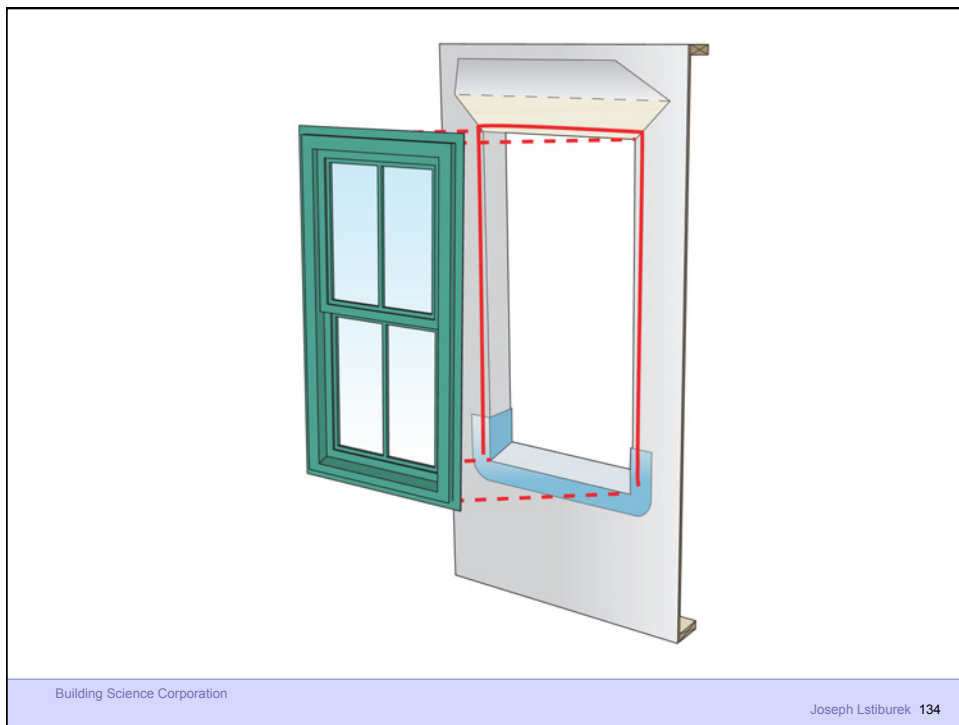
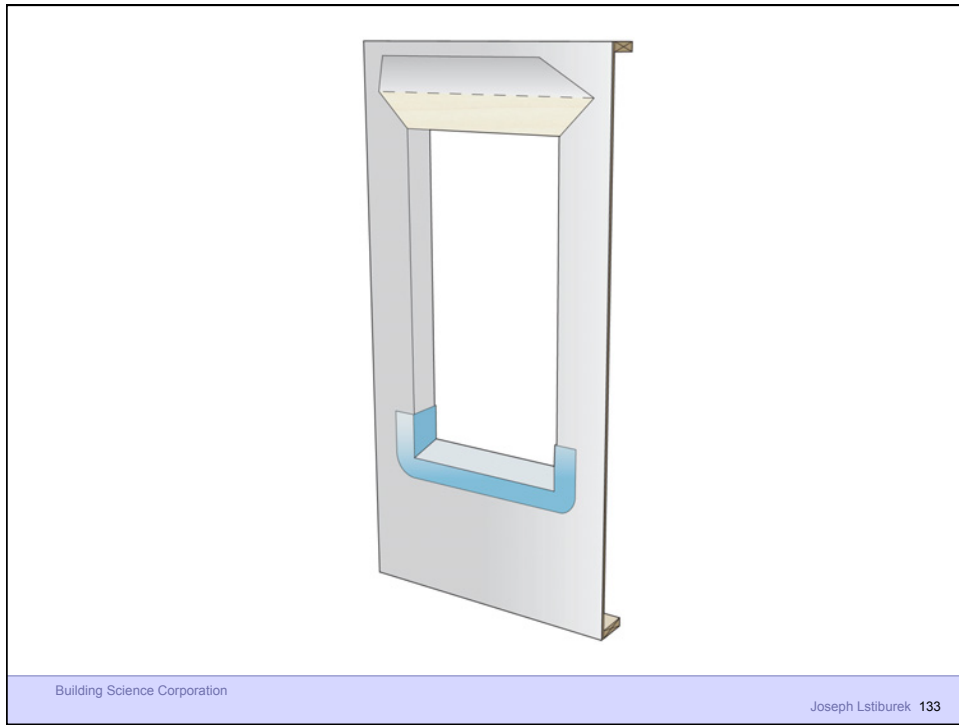

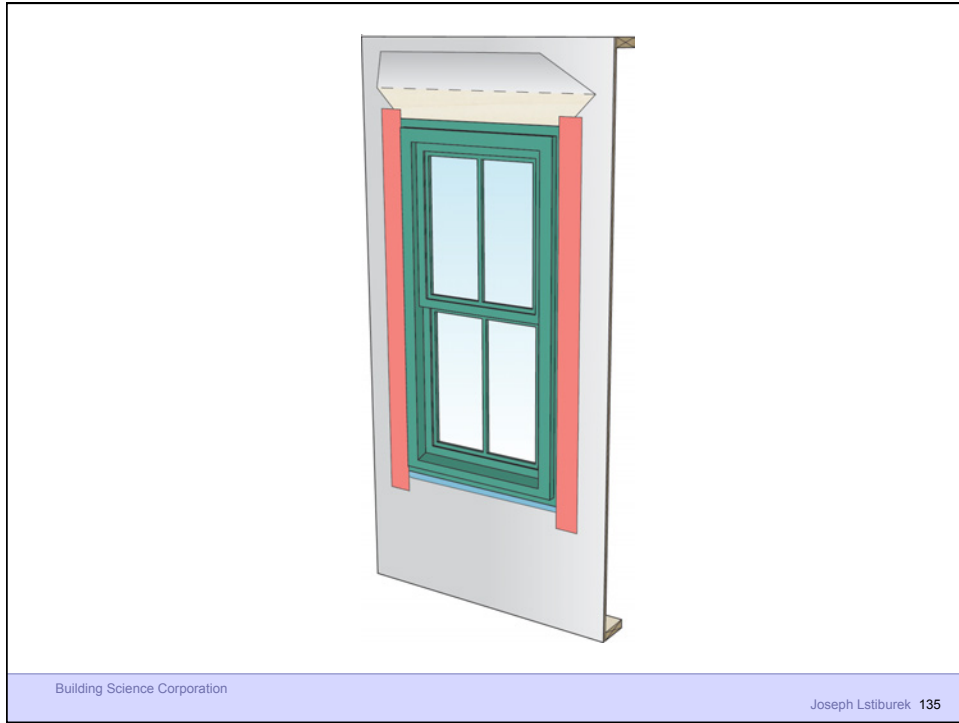

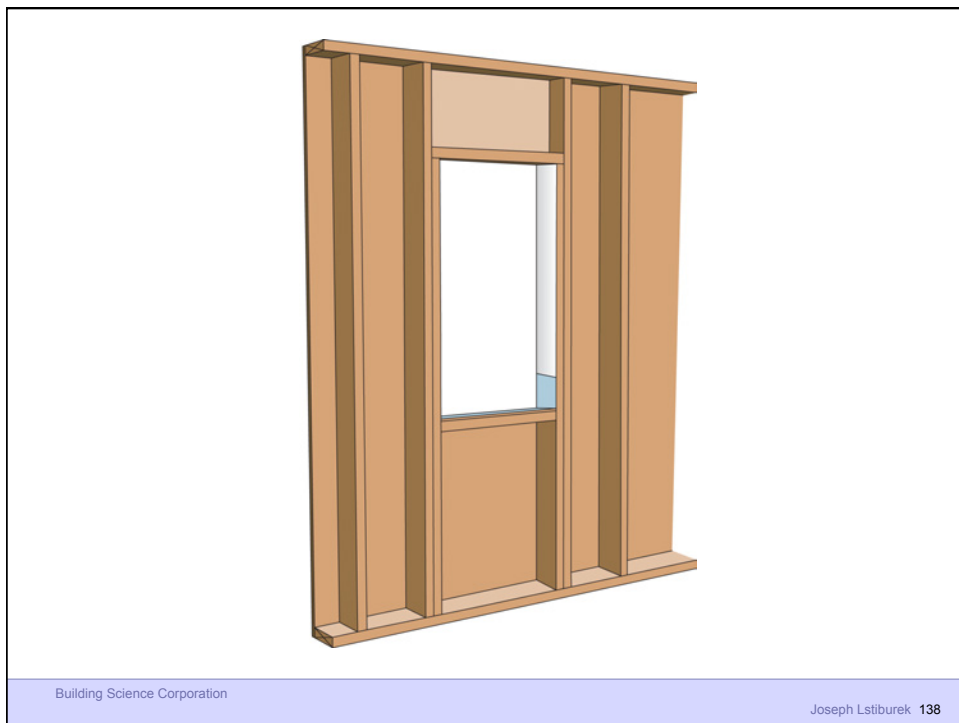
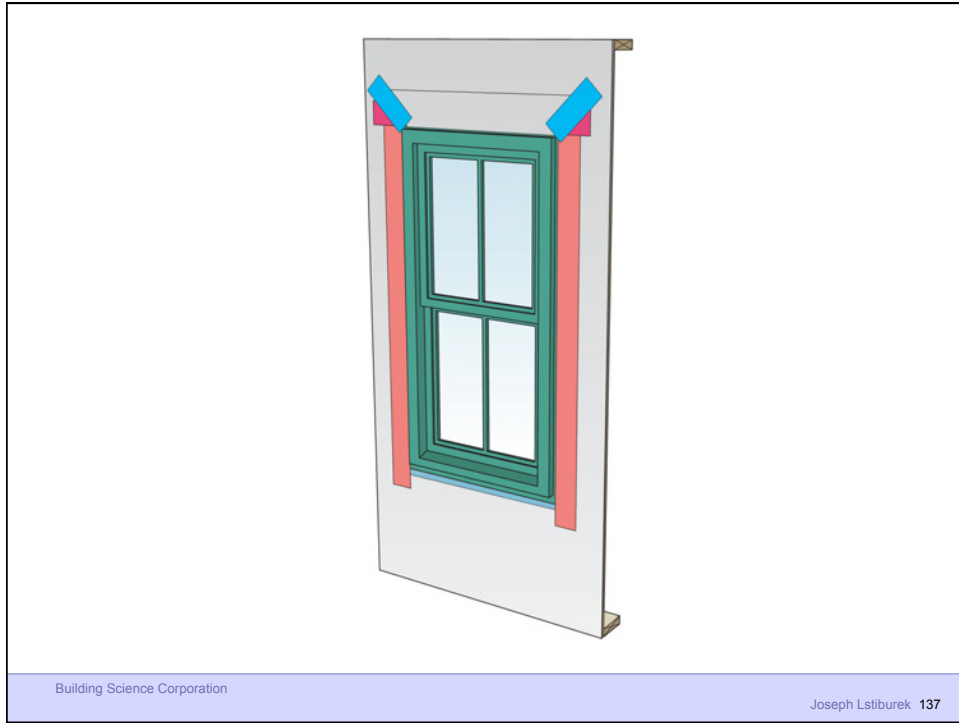

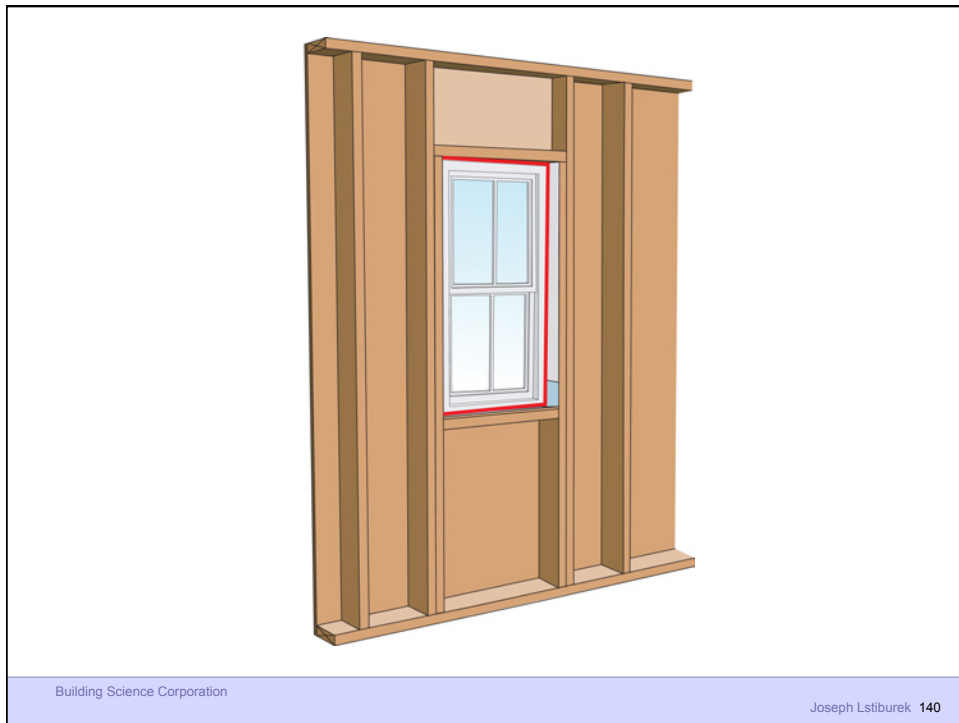
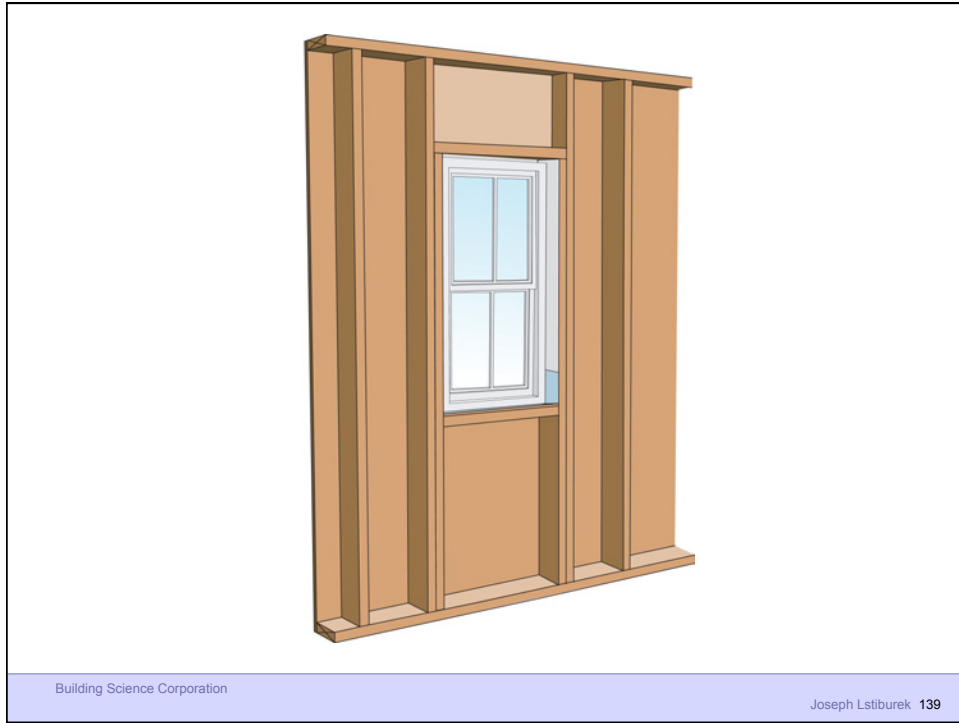



Building Science Corporation

Joseph Lstiburek 141



Building Science Corporation

Joseph Lstiburek 142



Building Science Corporation

Joseph Lstiburek 143



Building Science Corporation

Joseph Lstiburek 144

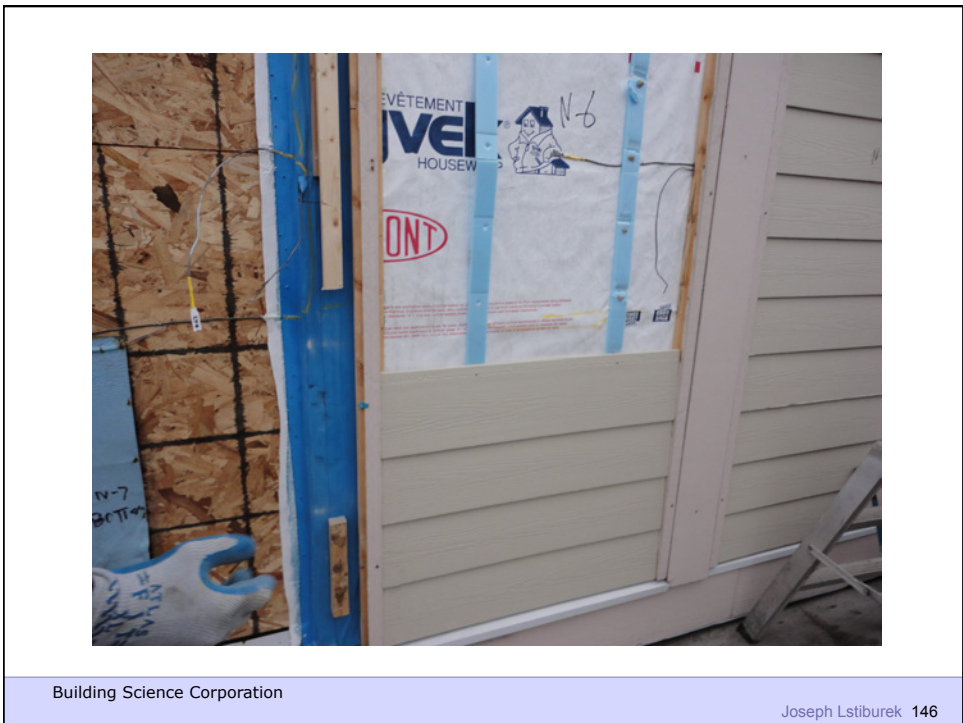



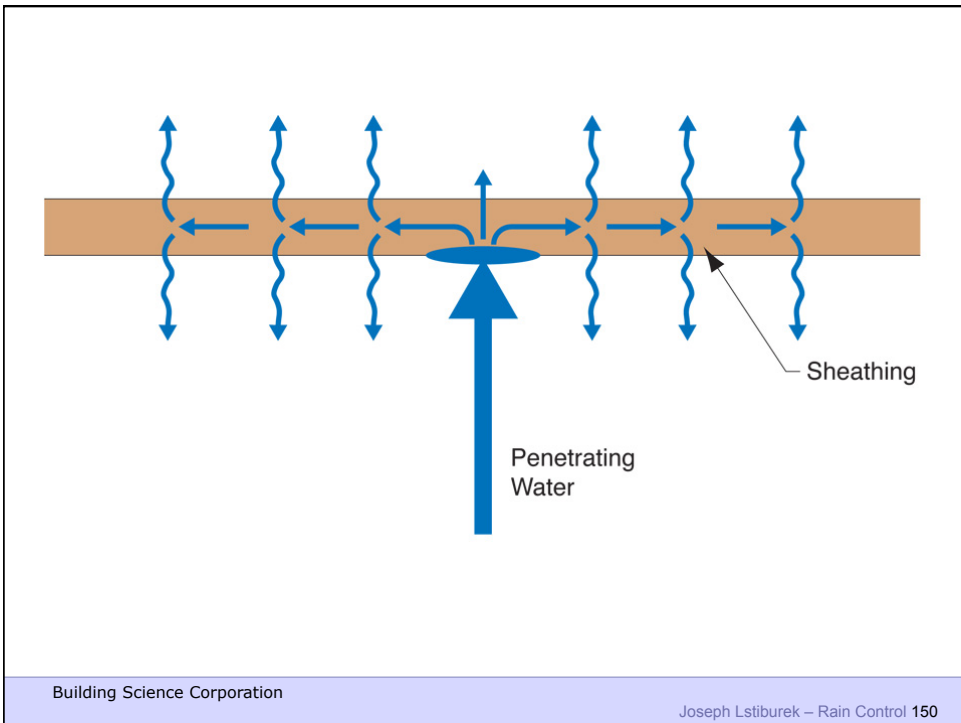

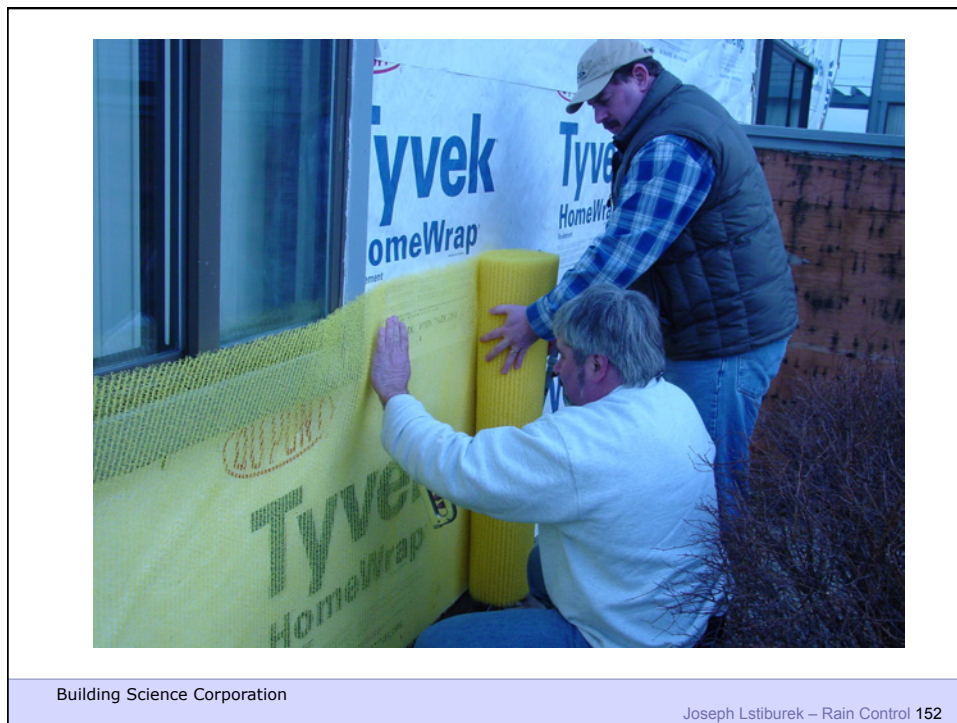
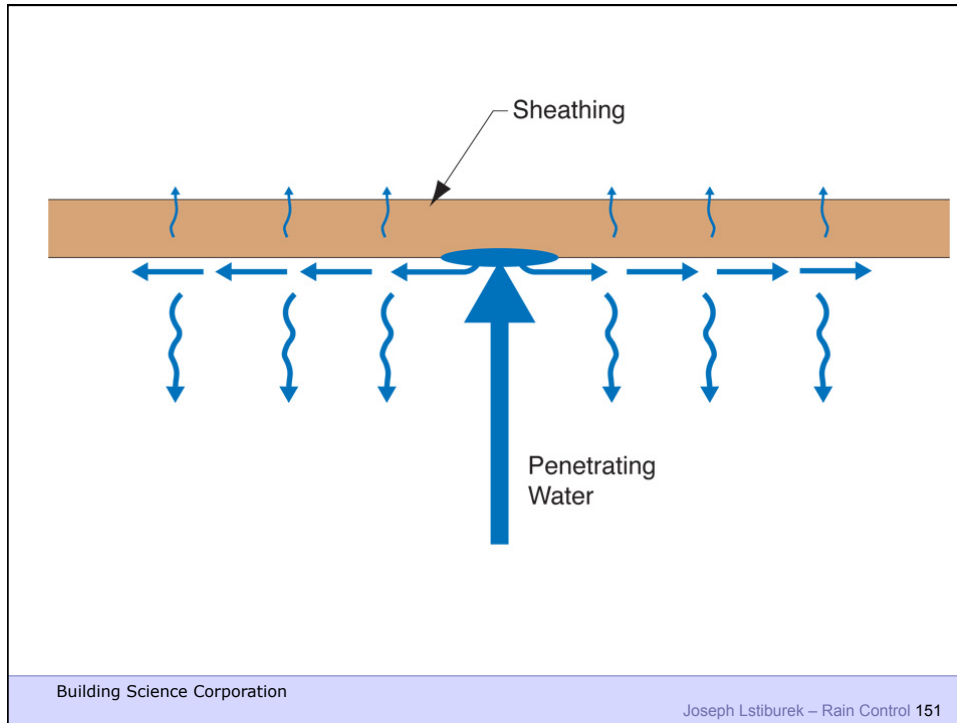

Rain Screen

Building Science Corporation

Joseph Lstiburek 153

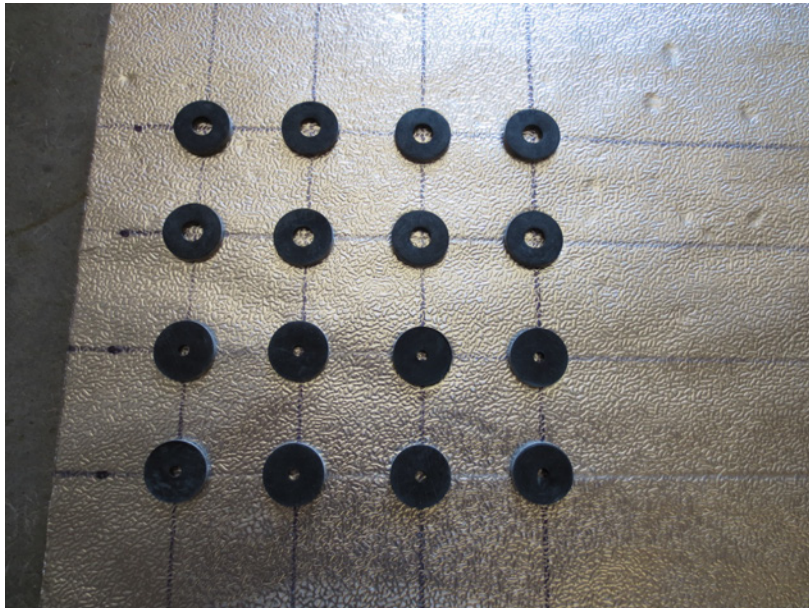

Building Science Corporation

Joseph Lstiburek 154

Beer Screen?

Building Science Corporation

Joseph Lstiburek 155

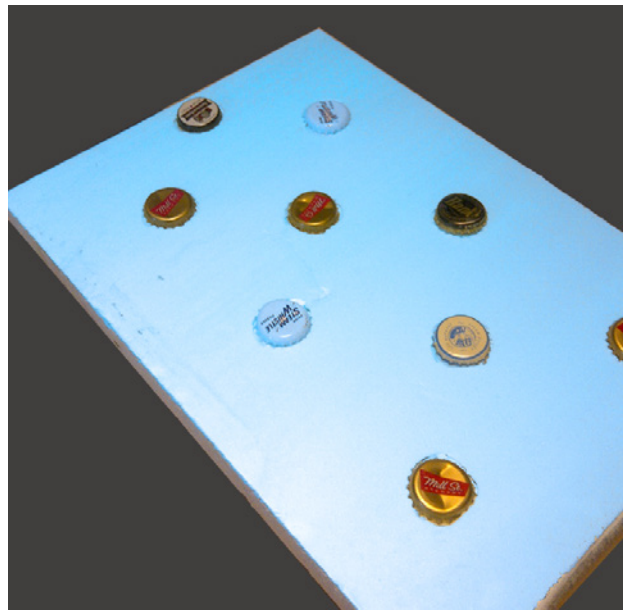

Building Science Corporation

Joseph Lstiburek 156

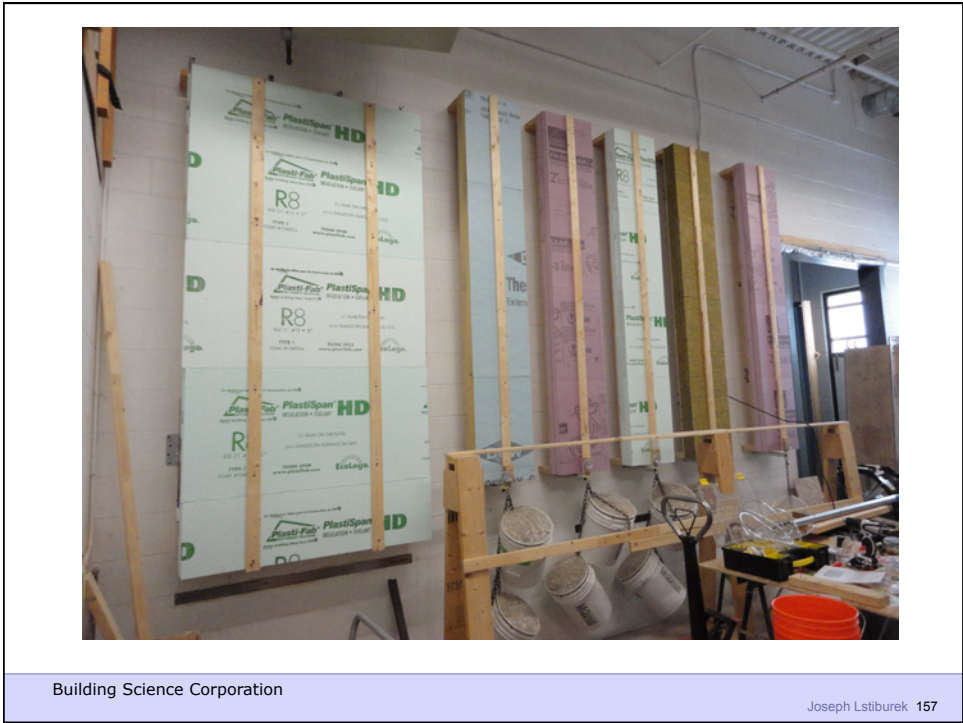



Rockwool

1x3 furring @ 24" o.c.
 #10 screws @ 16" o.c. vertically
 Result: 20 psf cladding weight
 with < 2/100" deflection

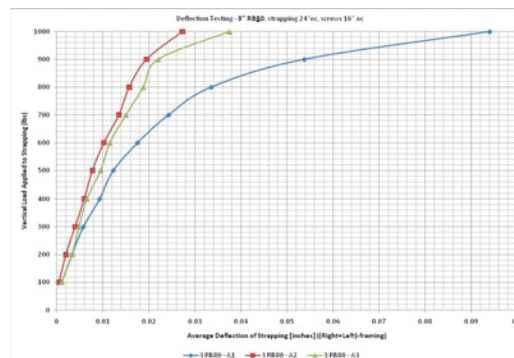



Building Science Corporation

Joseph Lstiburek 161



162

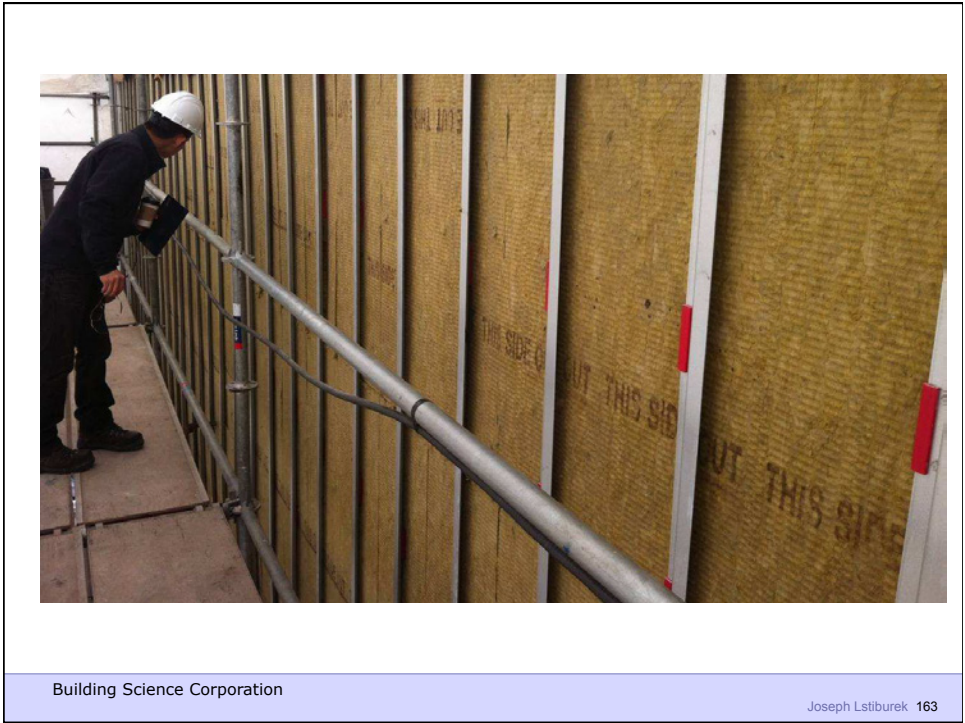

Building Science Corporation

Joseph Lstiburek 163

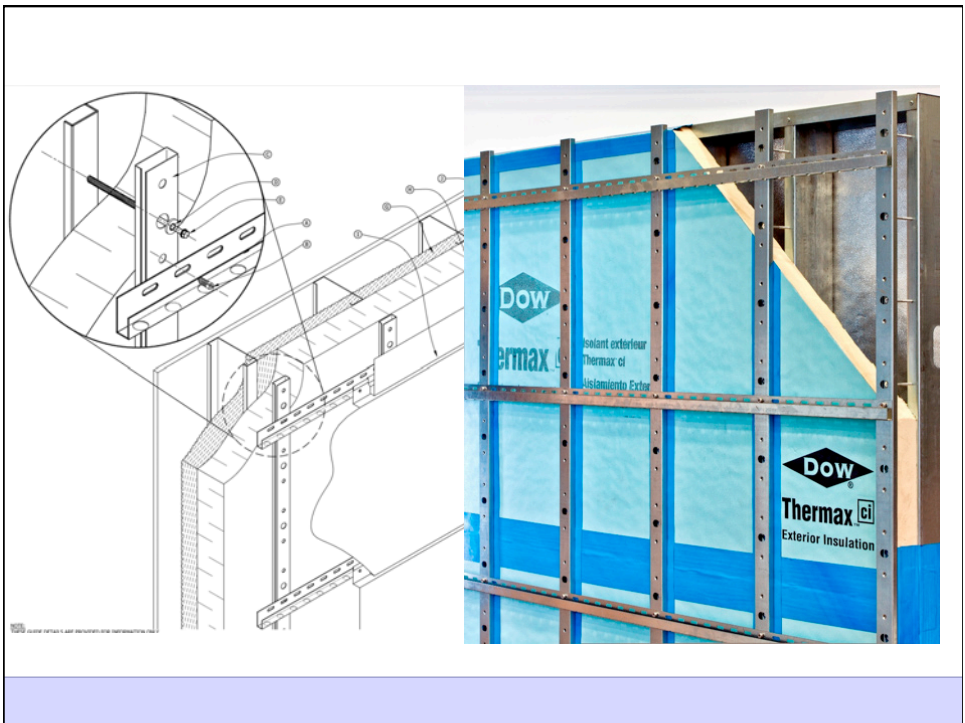

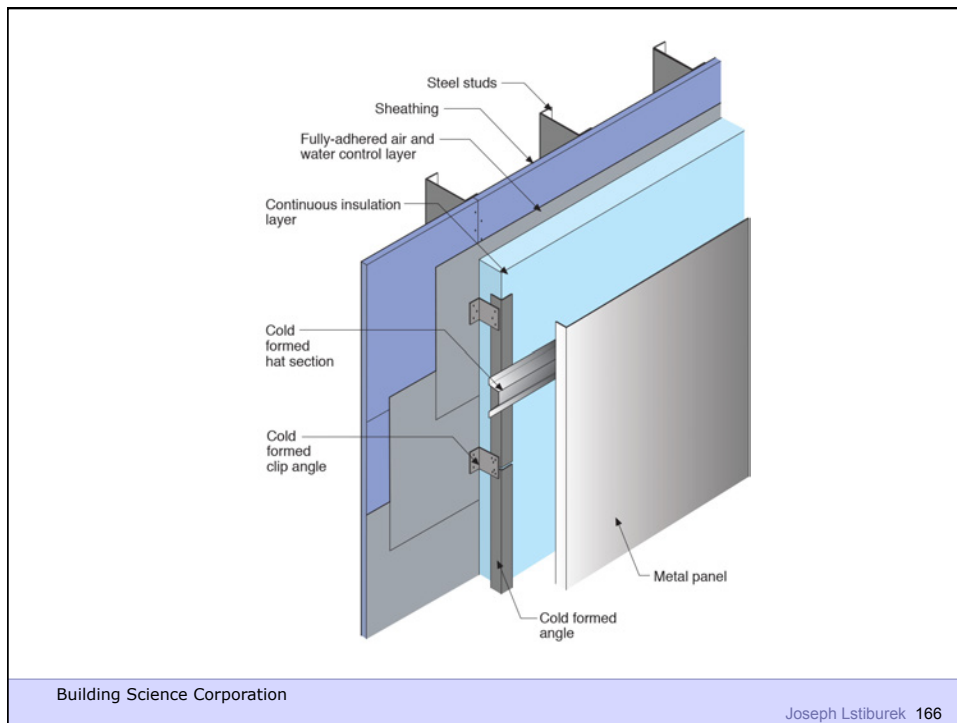
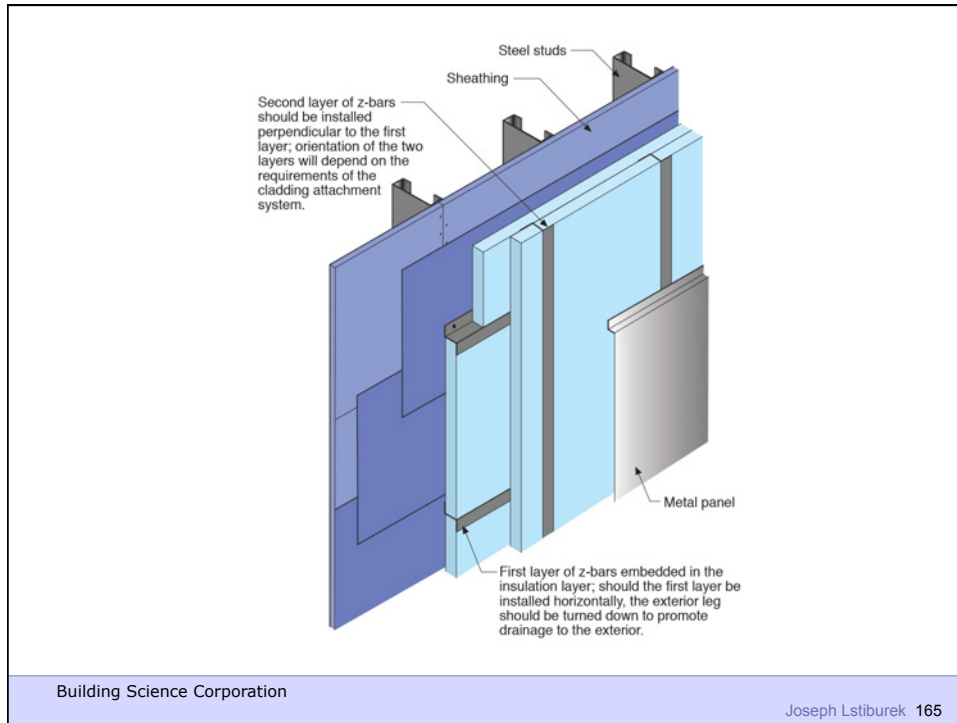

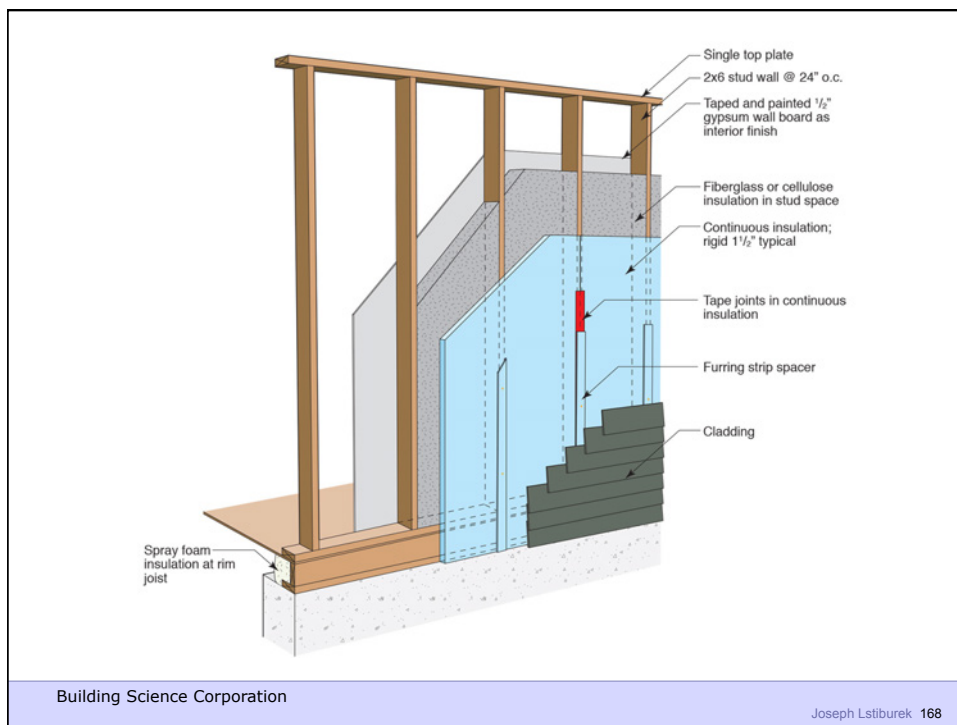
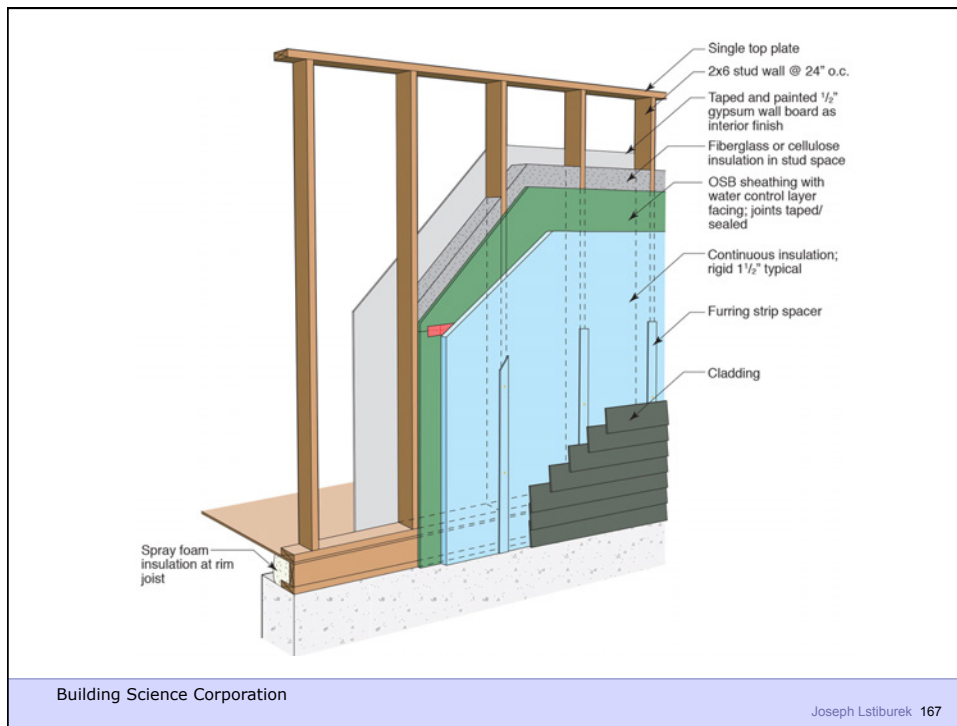

Innies and Outies

Building Science Corporation

Joseph Lstiburek 169

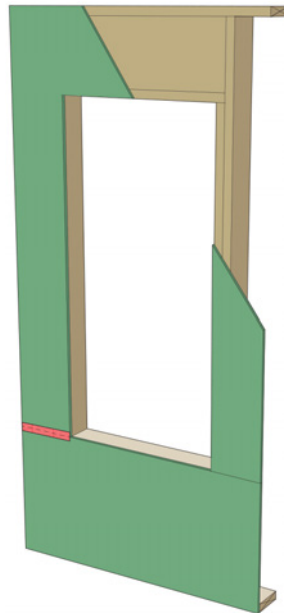

Building Science Corporation

Joseph Lstiburek 170

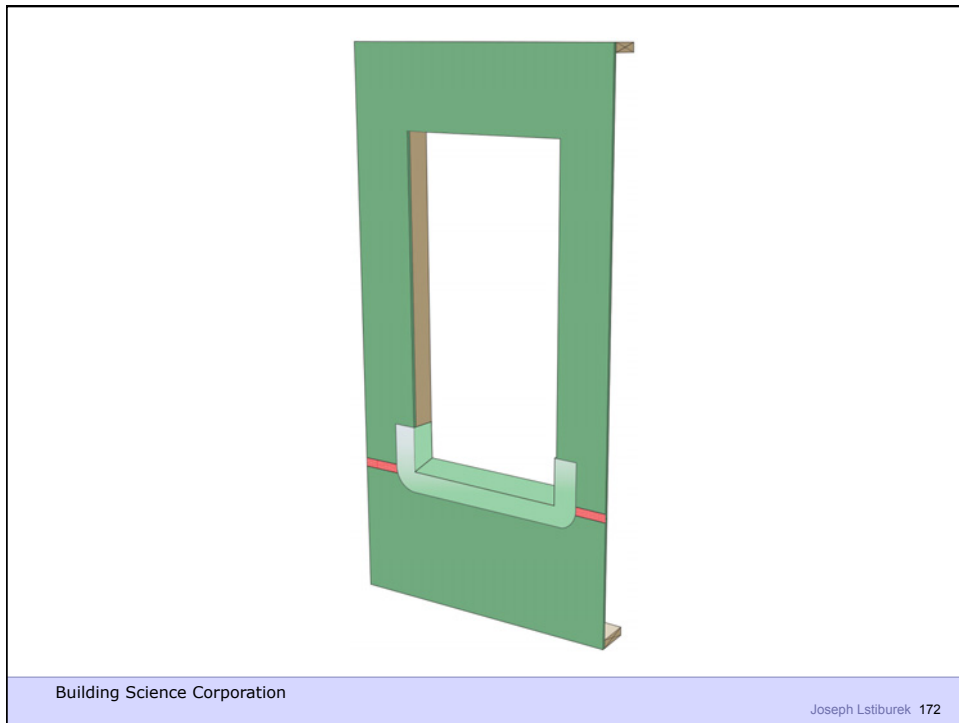
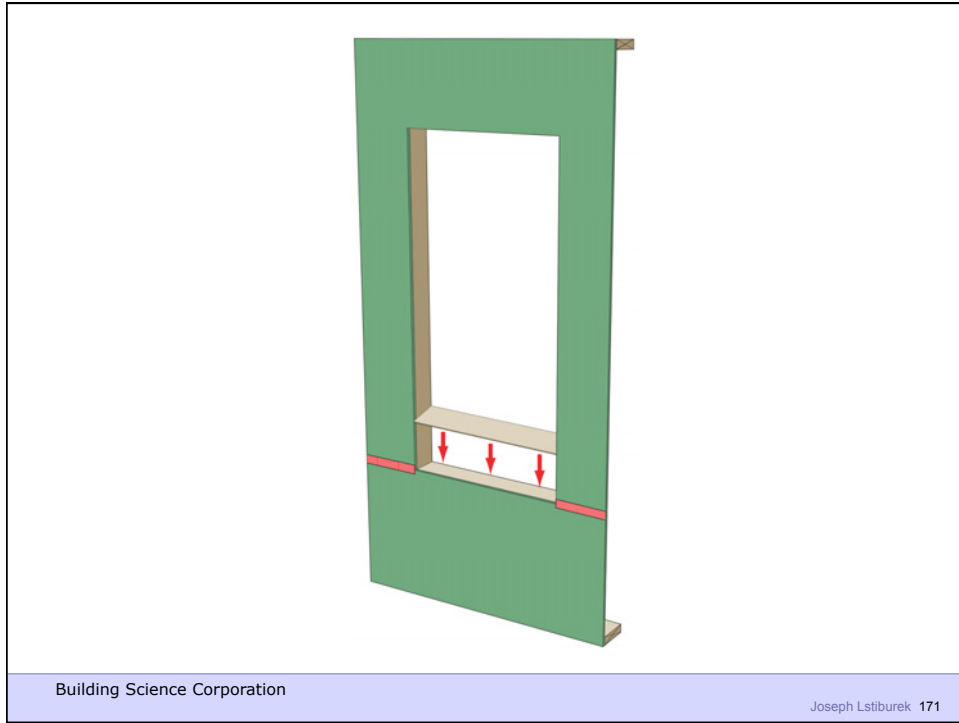

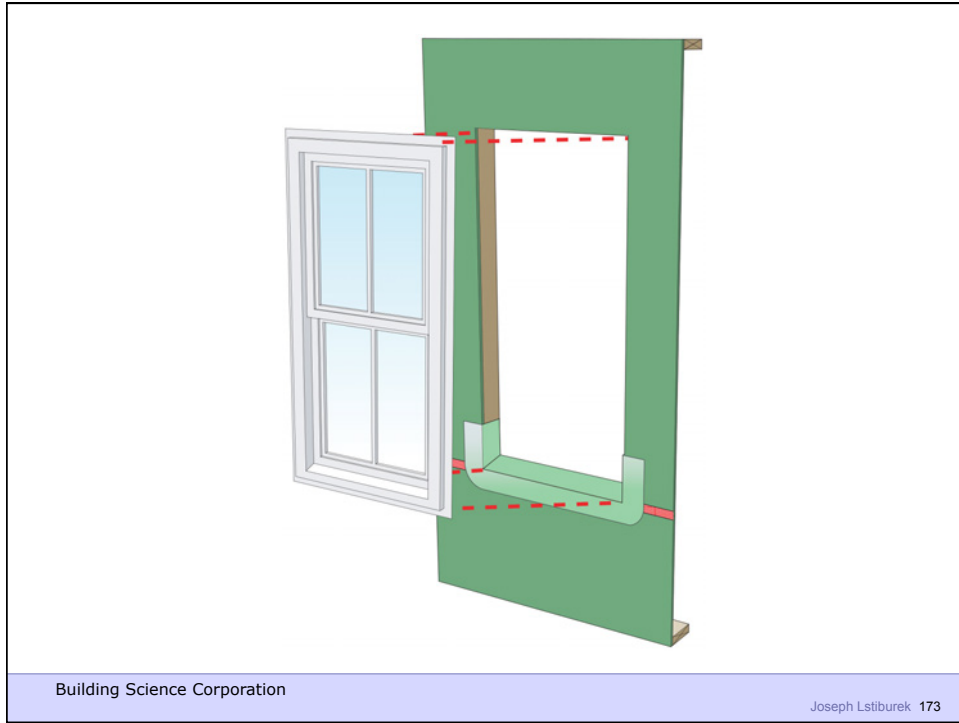

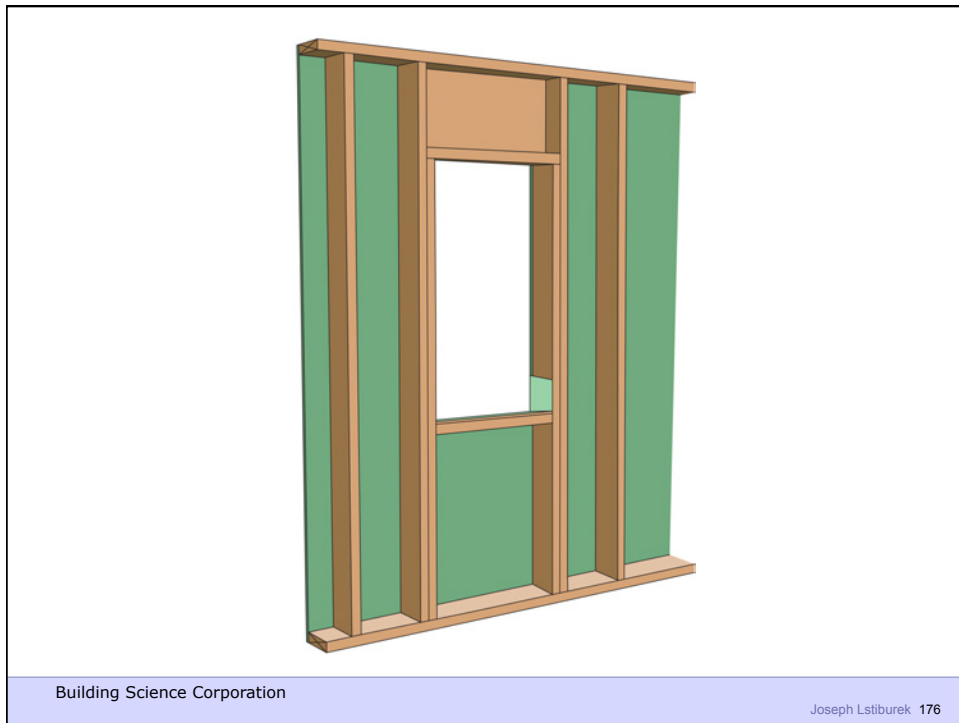
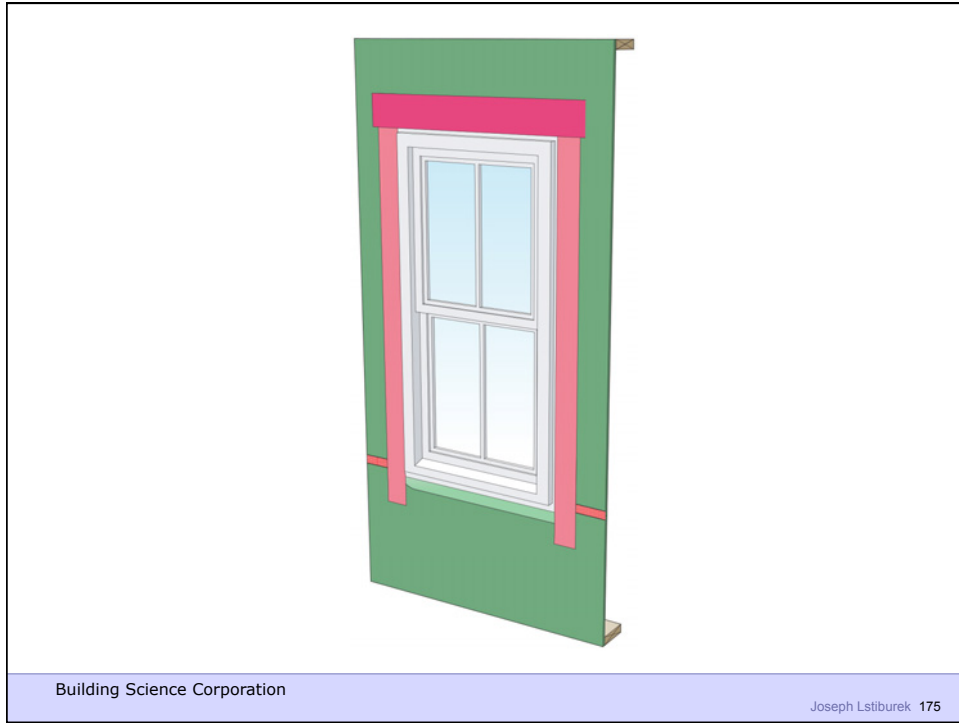

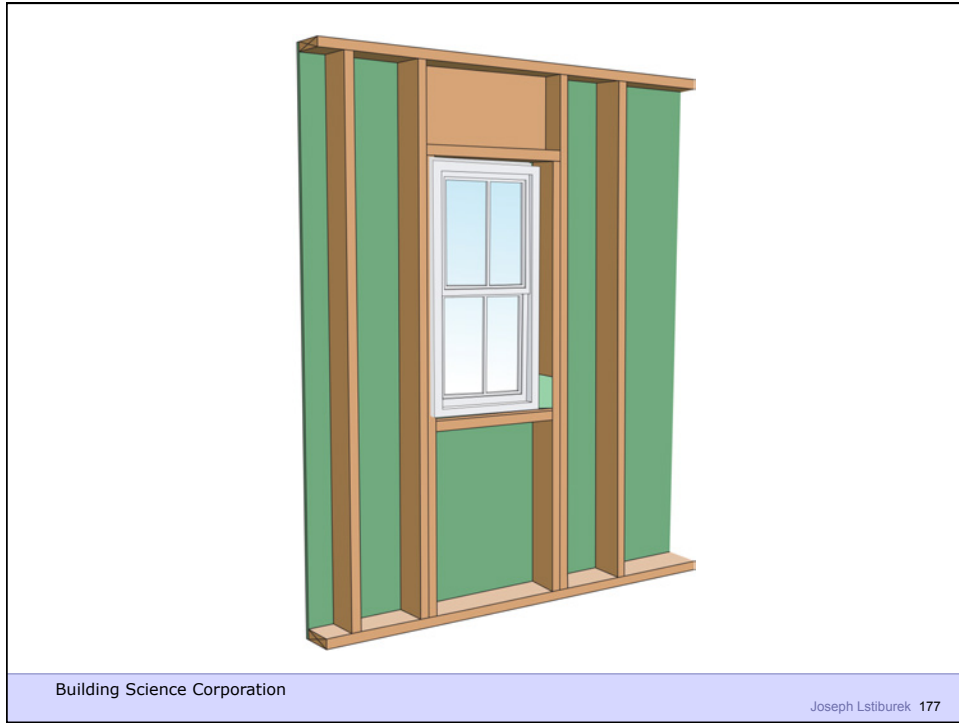

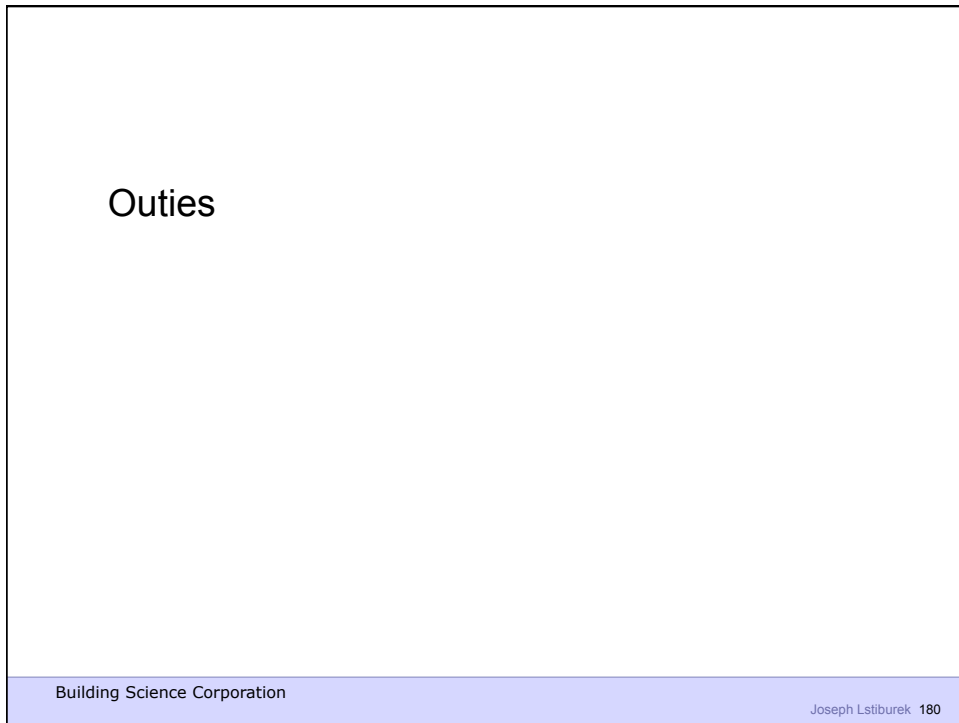
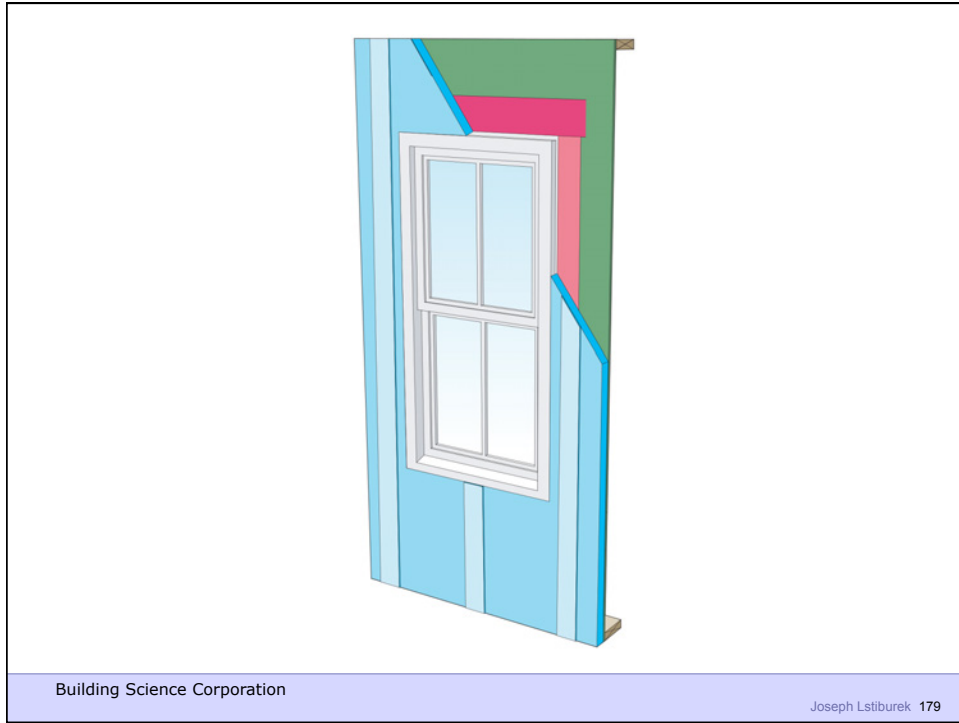

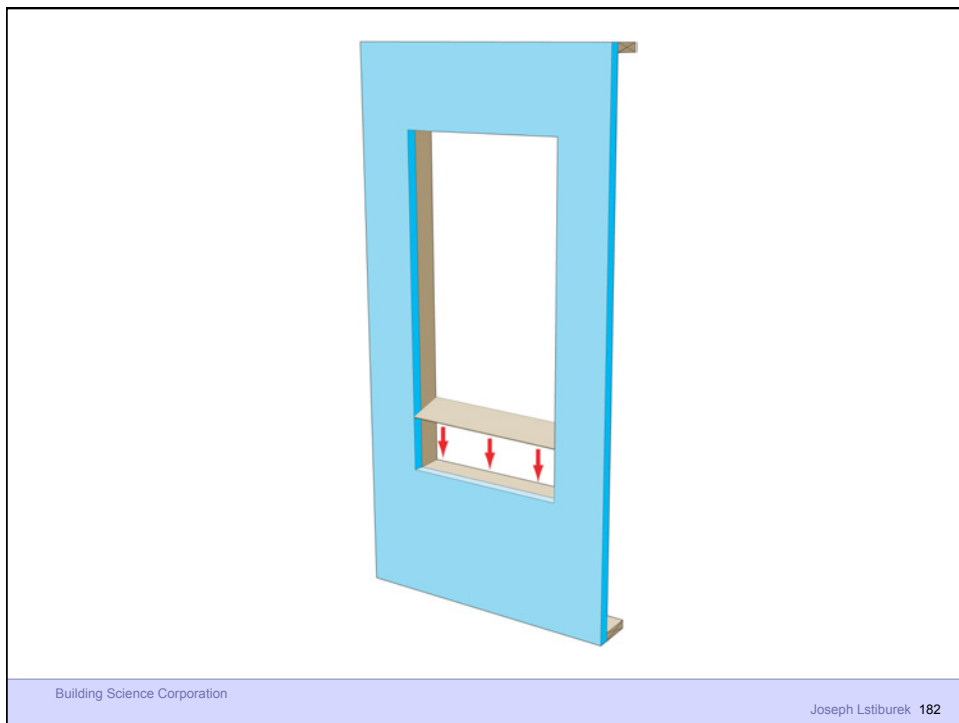
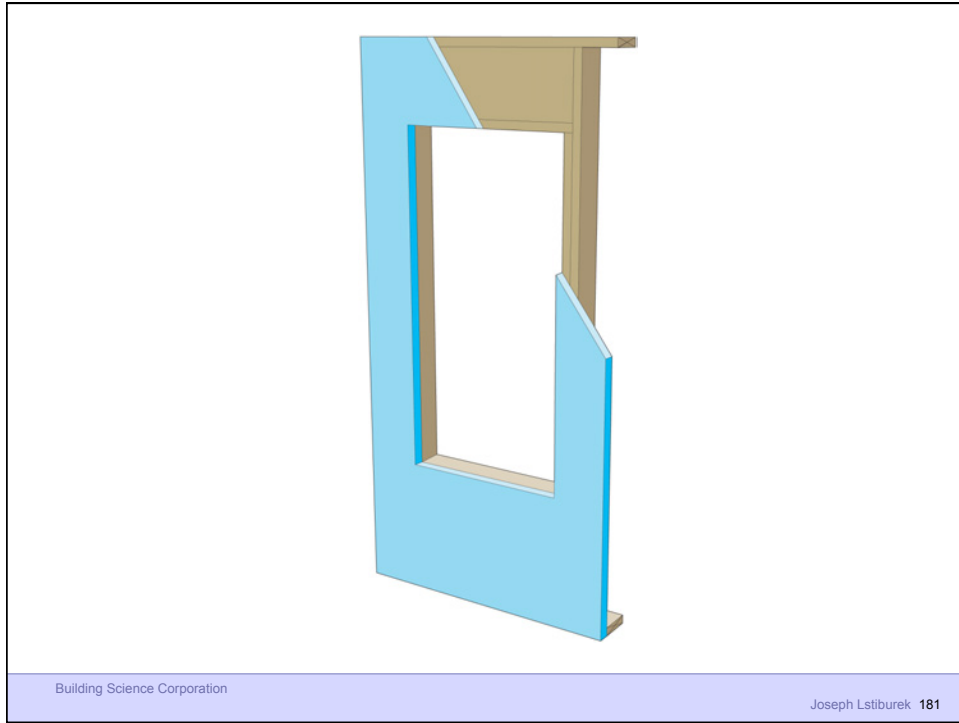

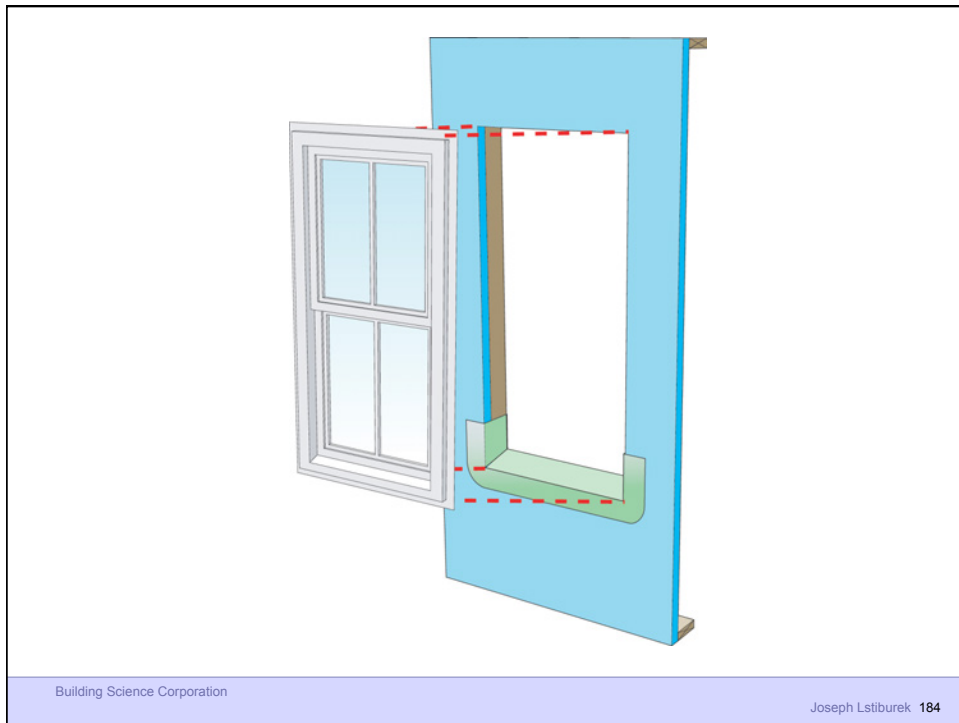
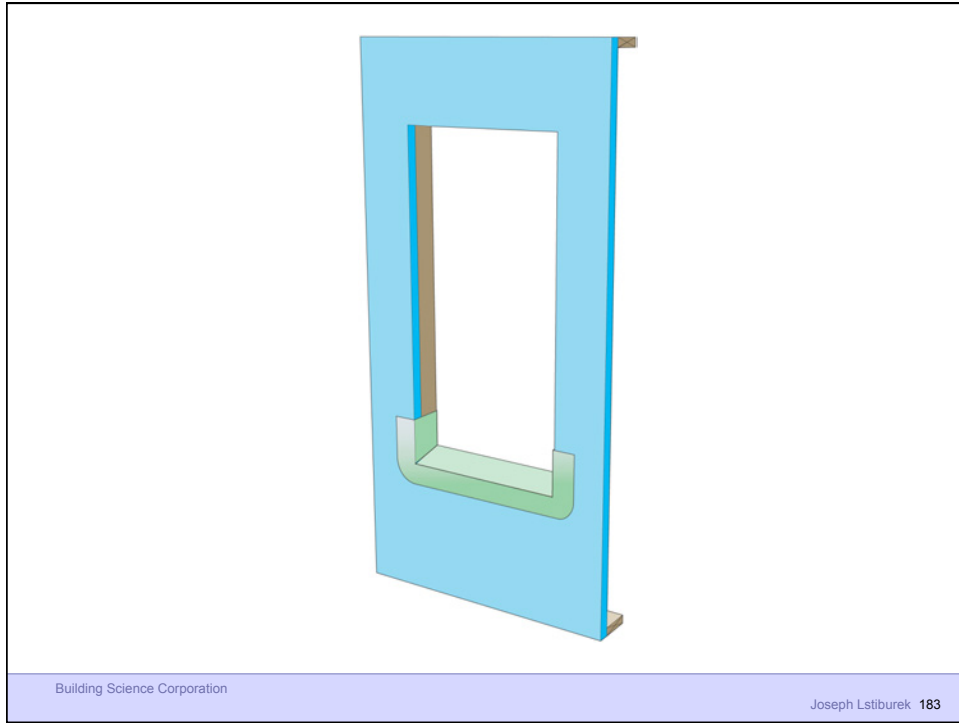

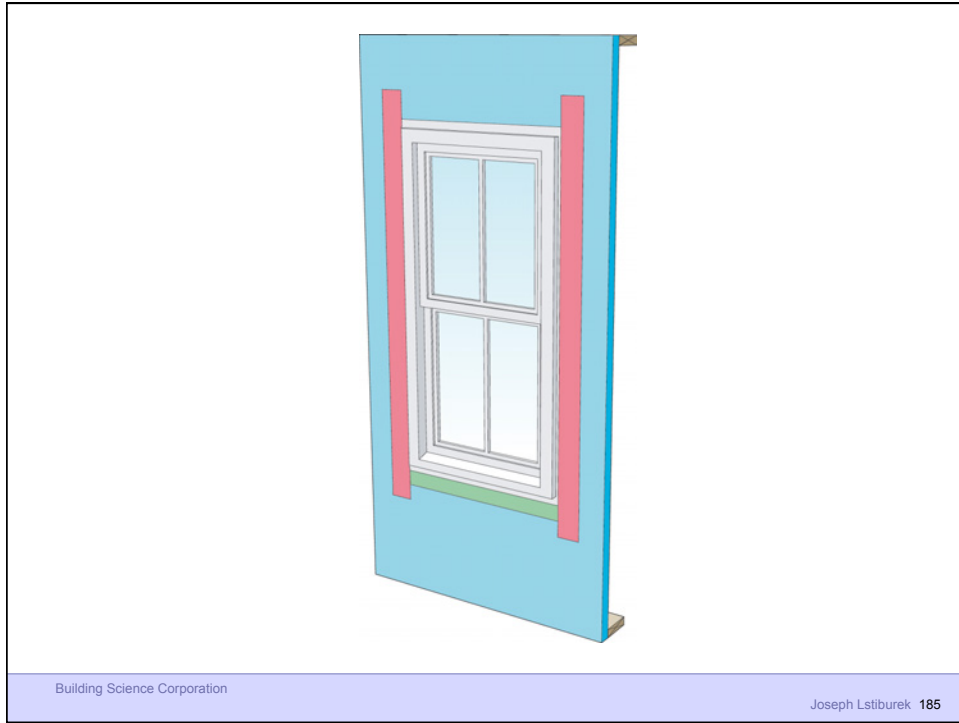

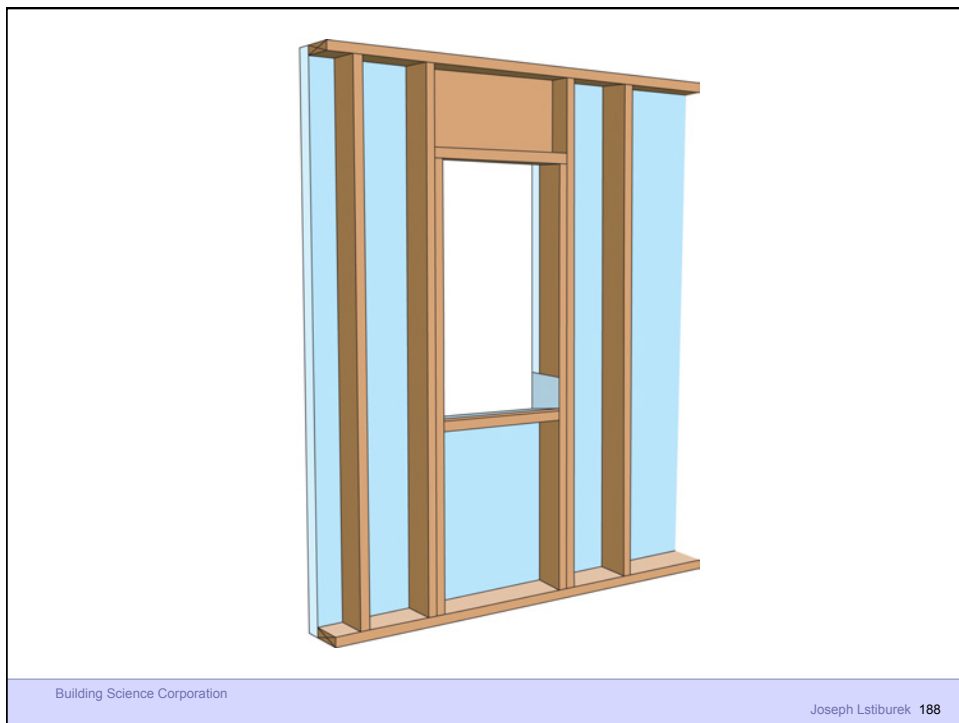
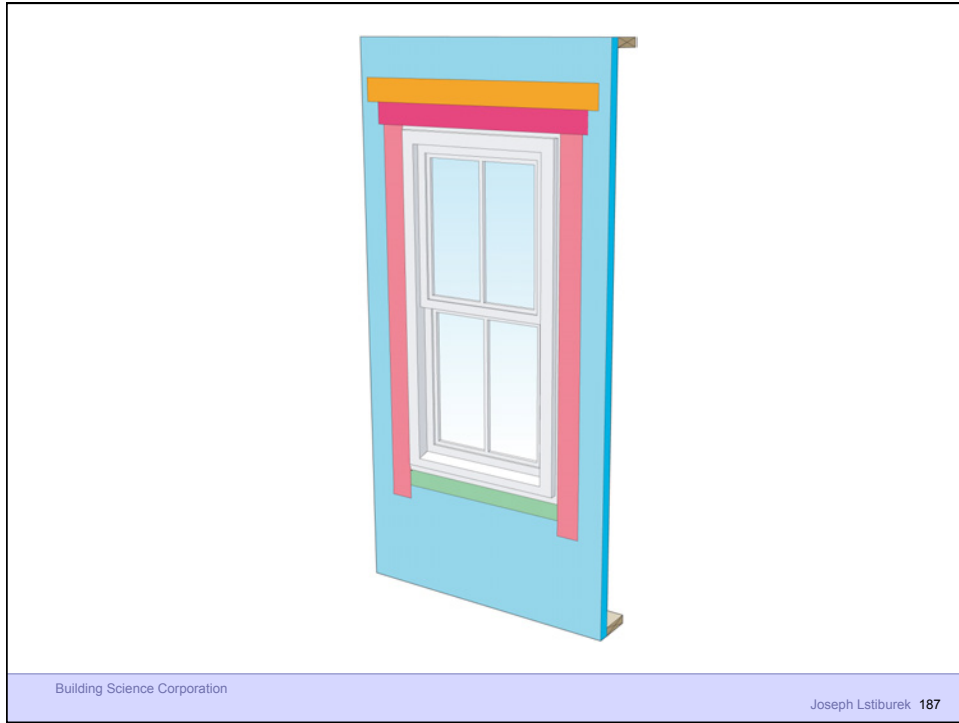



Outies with Fluffy Rocks

Building Science Corporation

Joseph Lstiburek 191

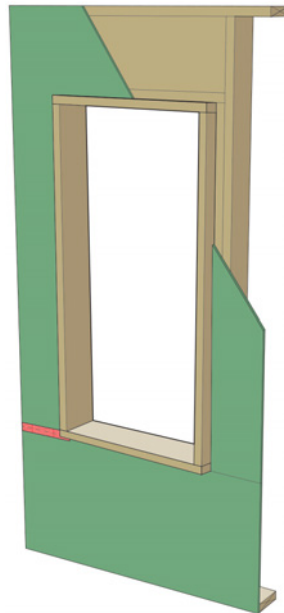

Building Science Corporation

Joseph Lstiburek 192

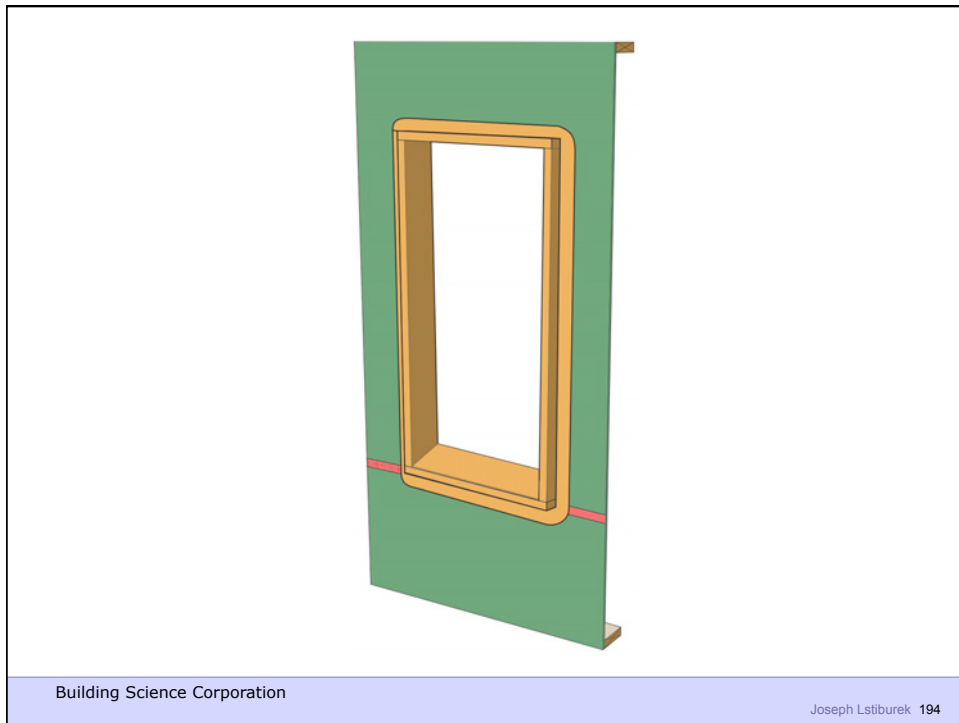
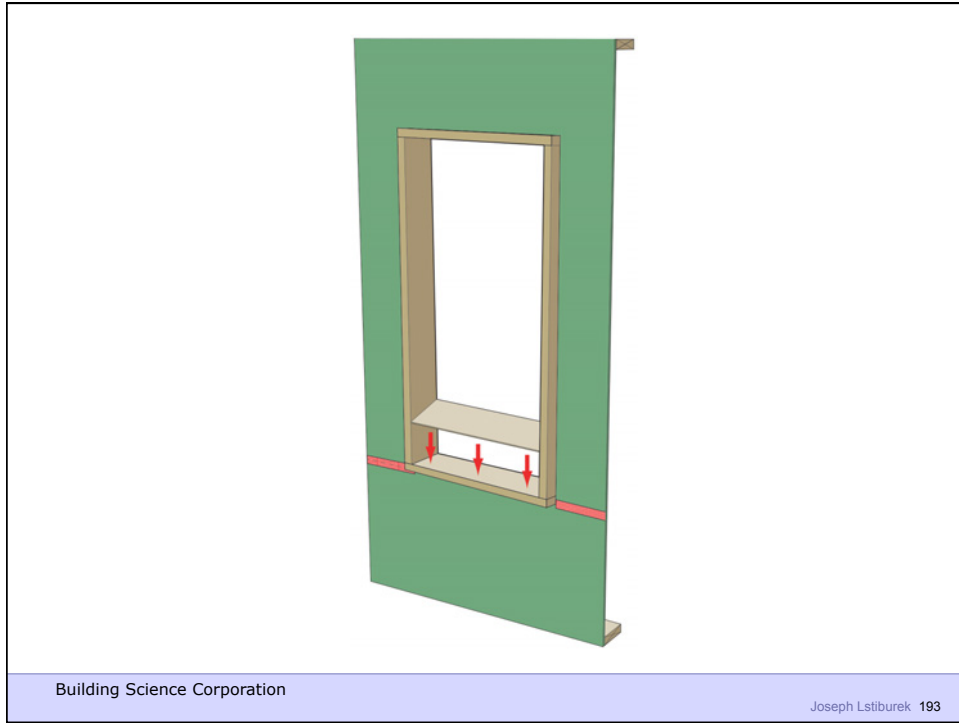

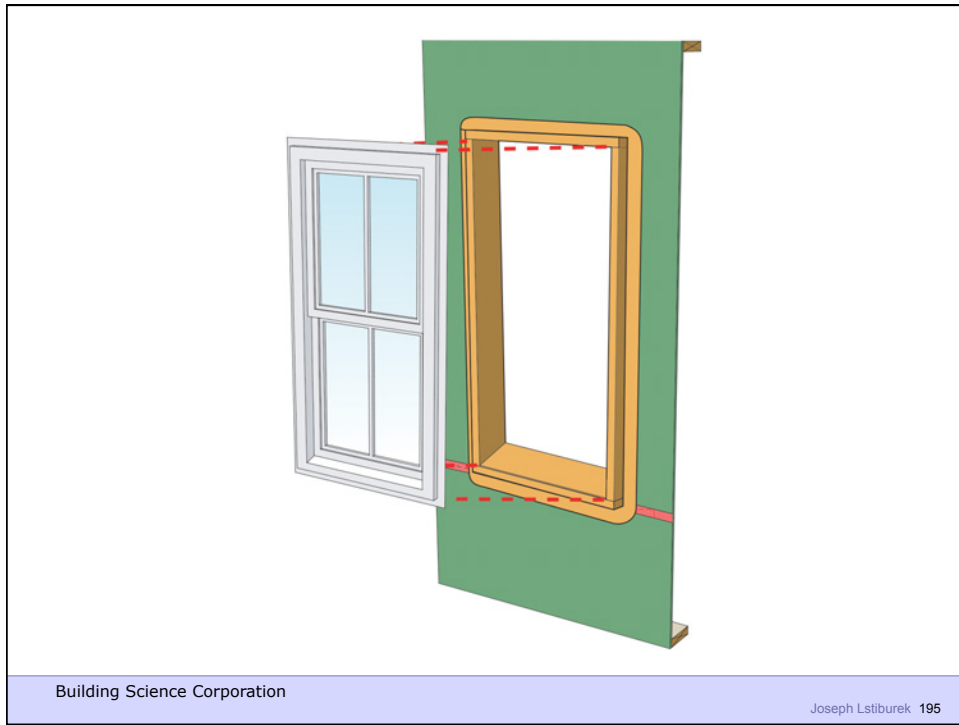





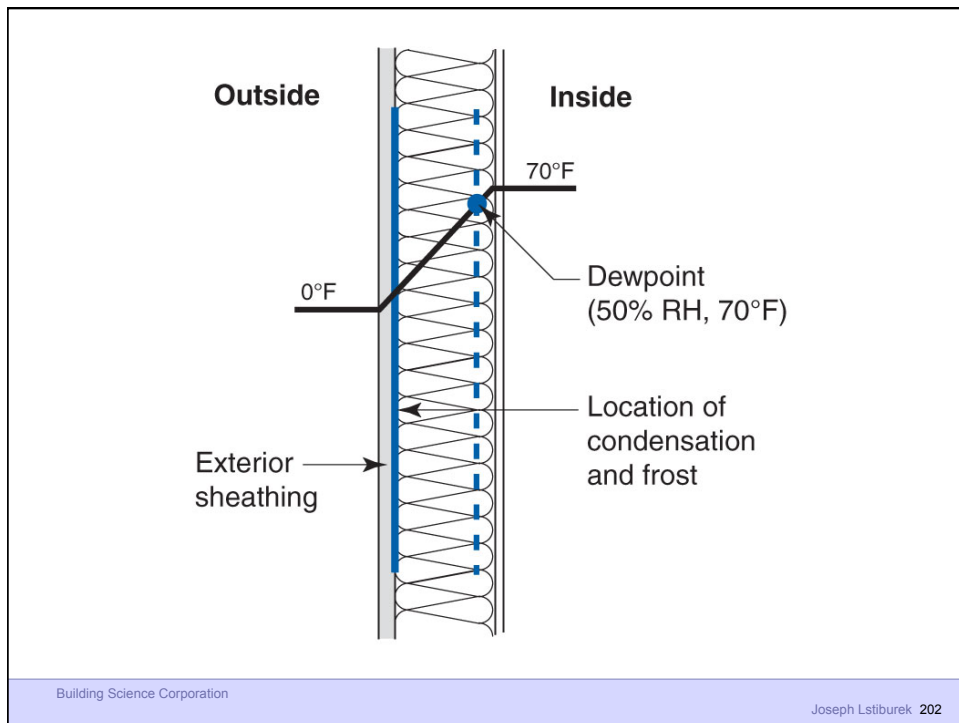



Building Science Corporation

Joseph Lstiburek 203

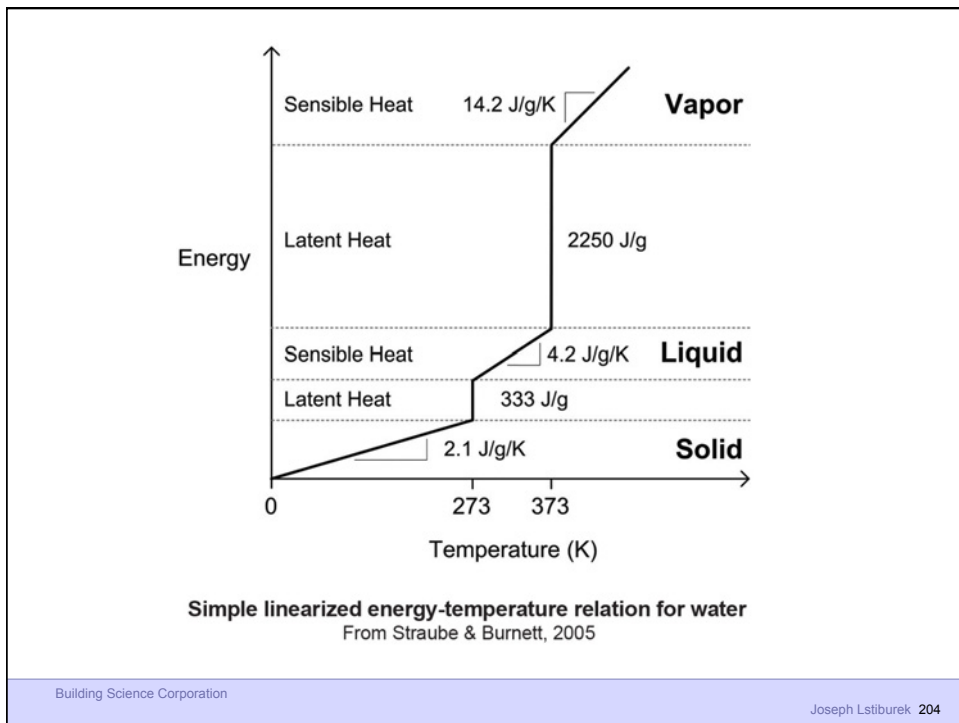

Building Science Corporation

Joseph Lstiburek 204

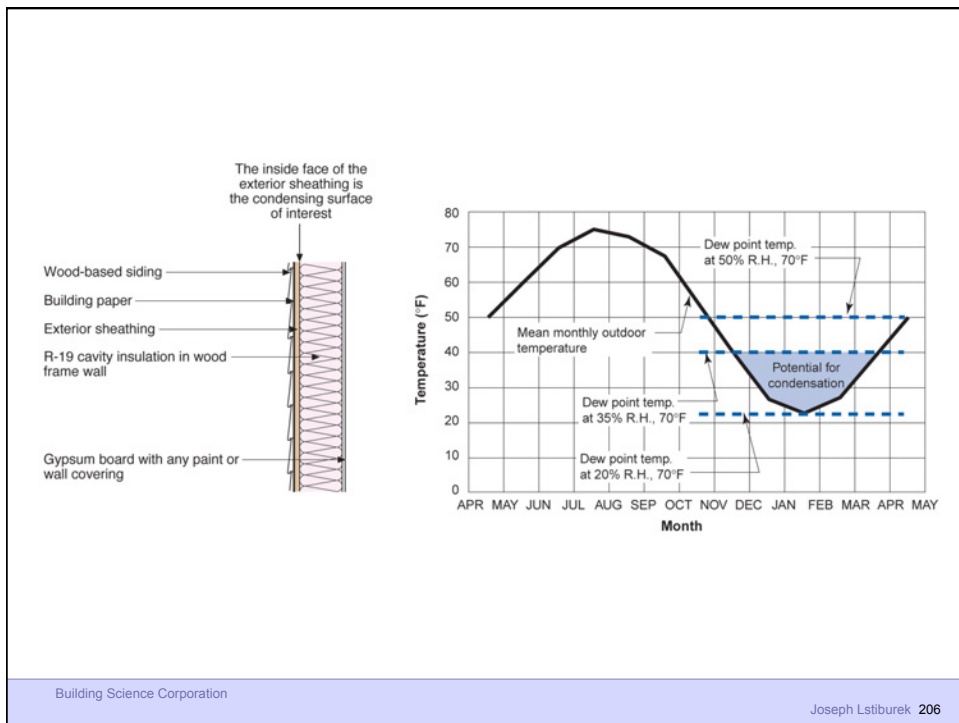
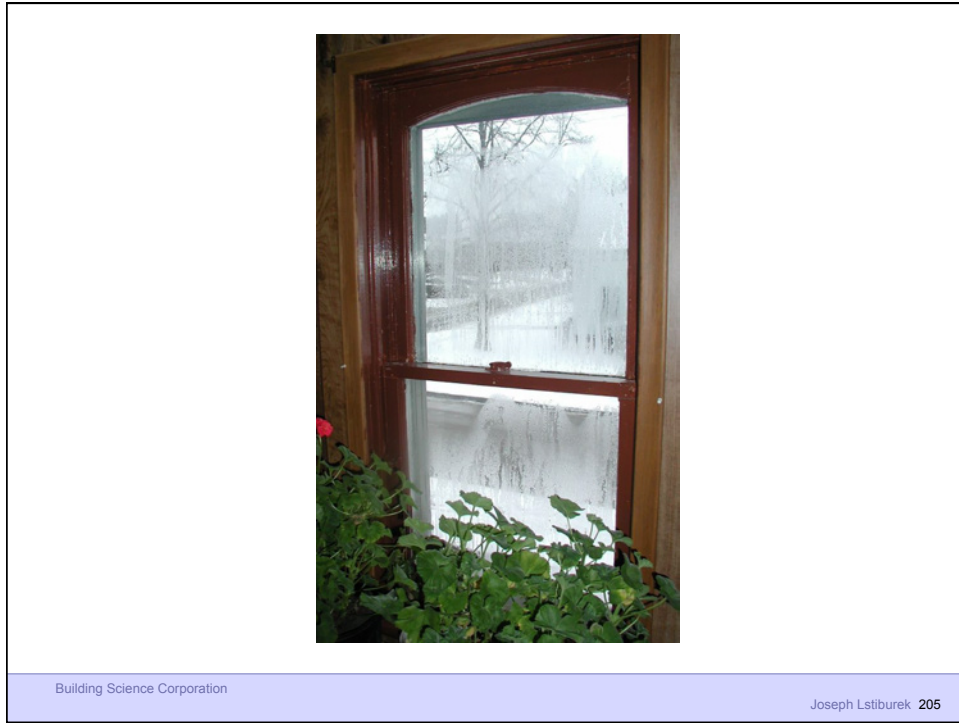

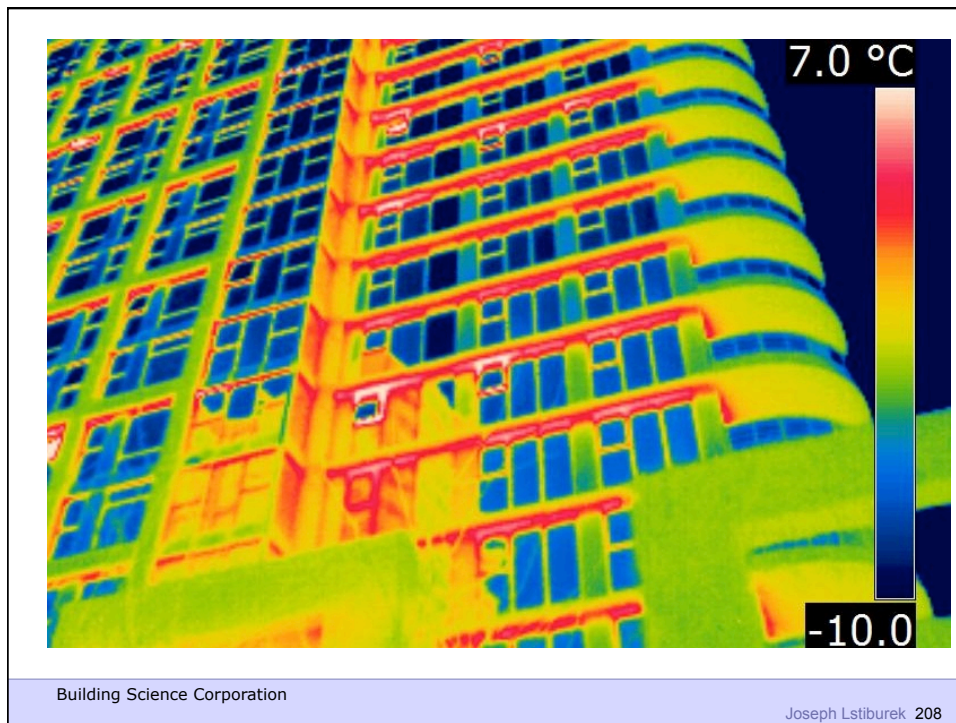
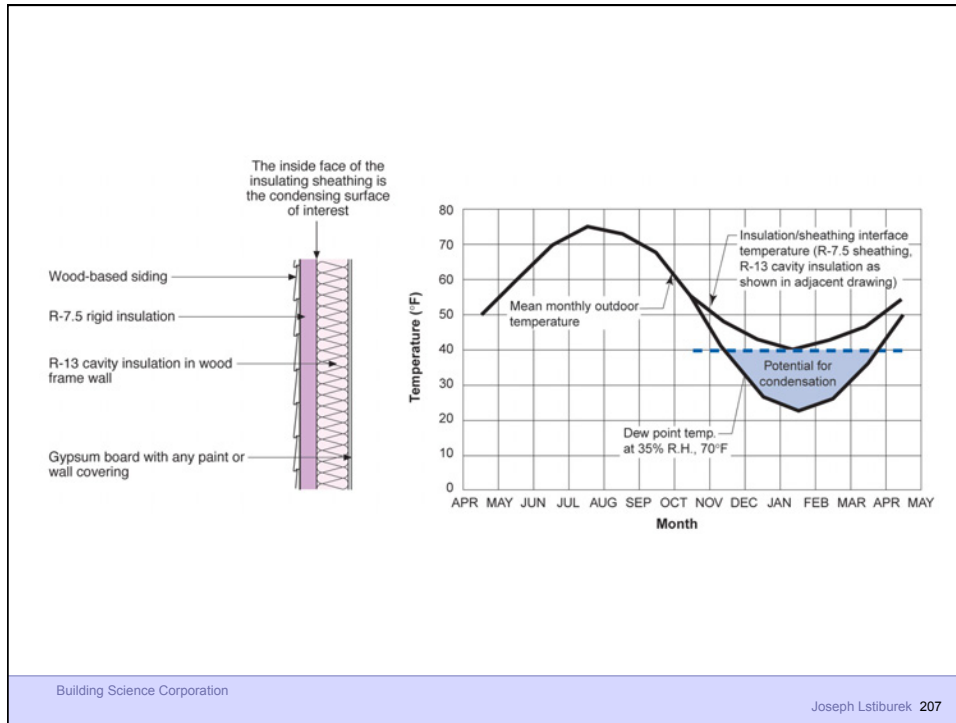

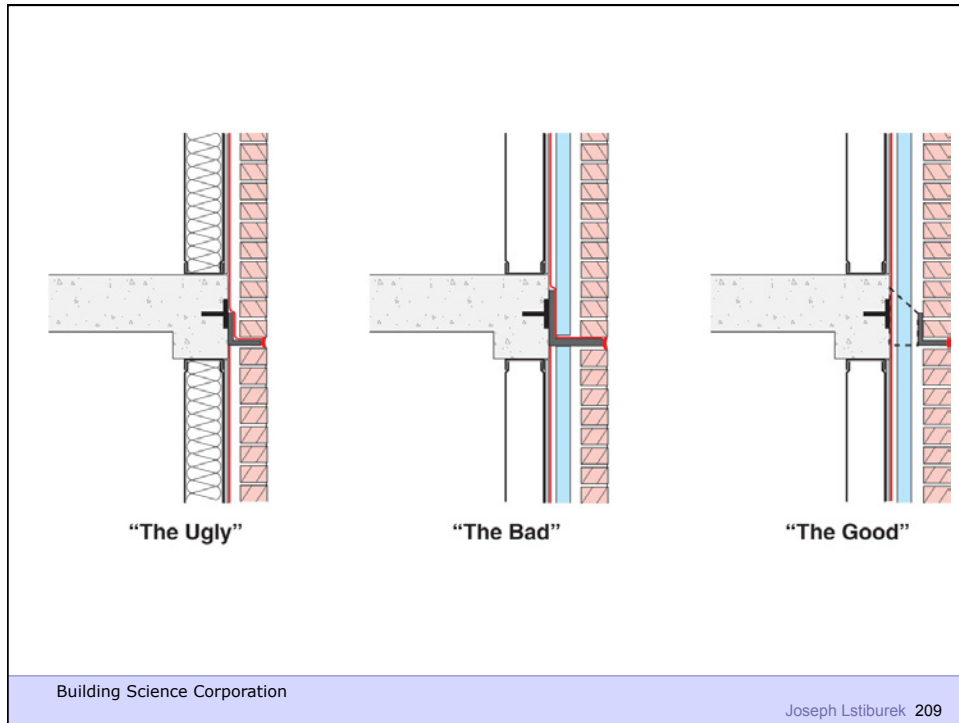

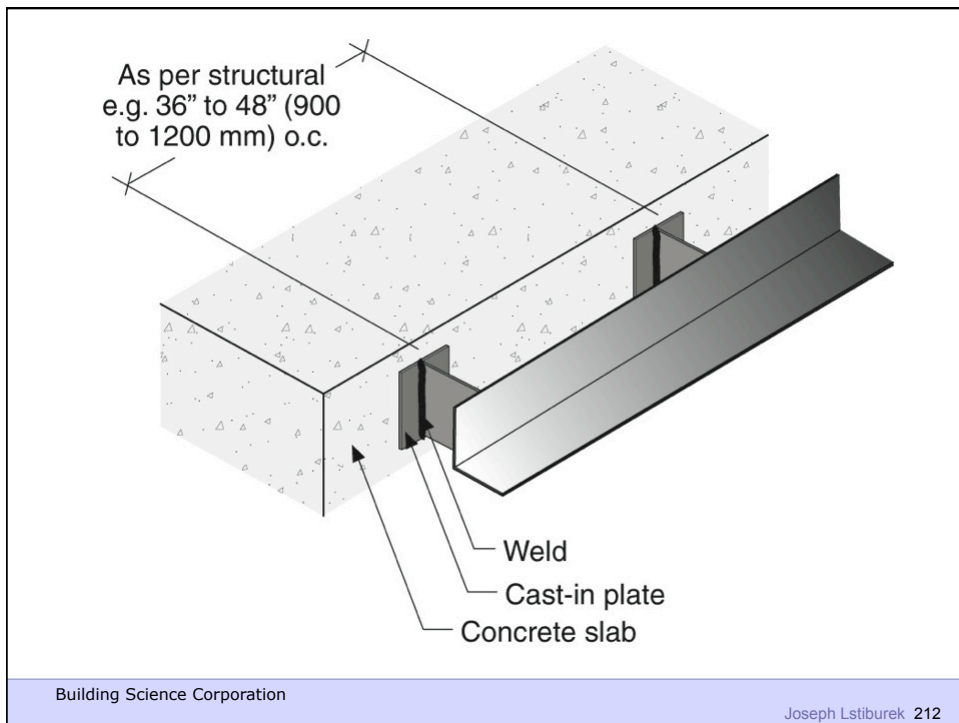



Building Science Corporation

Joseph Lstiburek 213



Building Science Corporation

Joseph Lstiburek 214

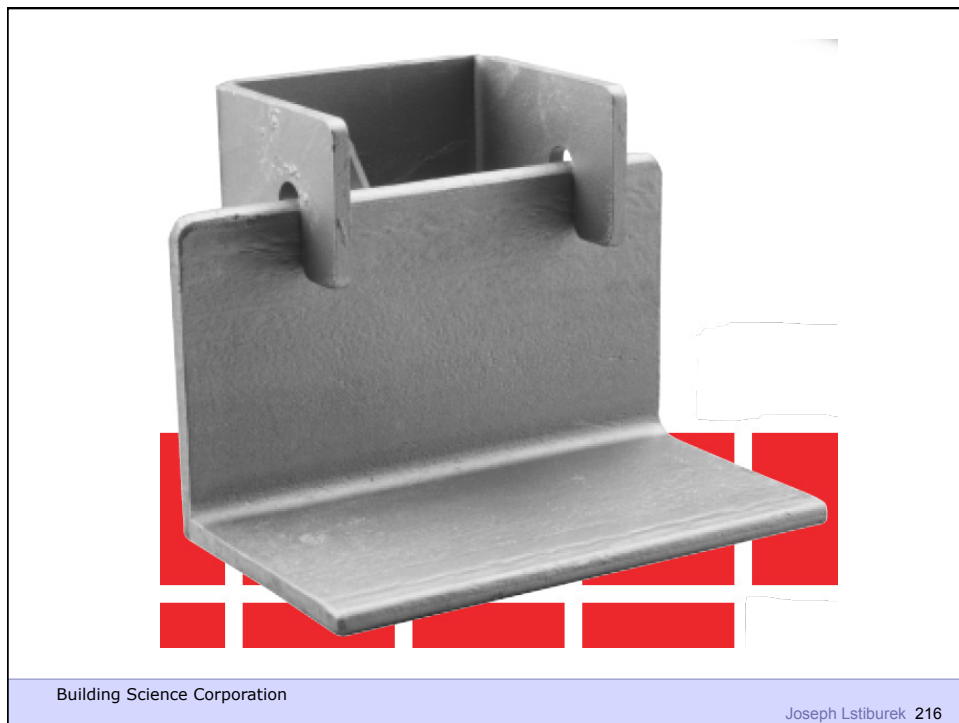
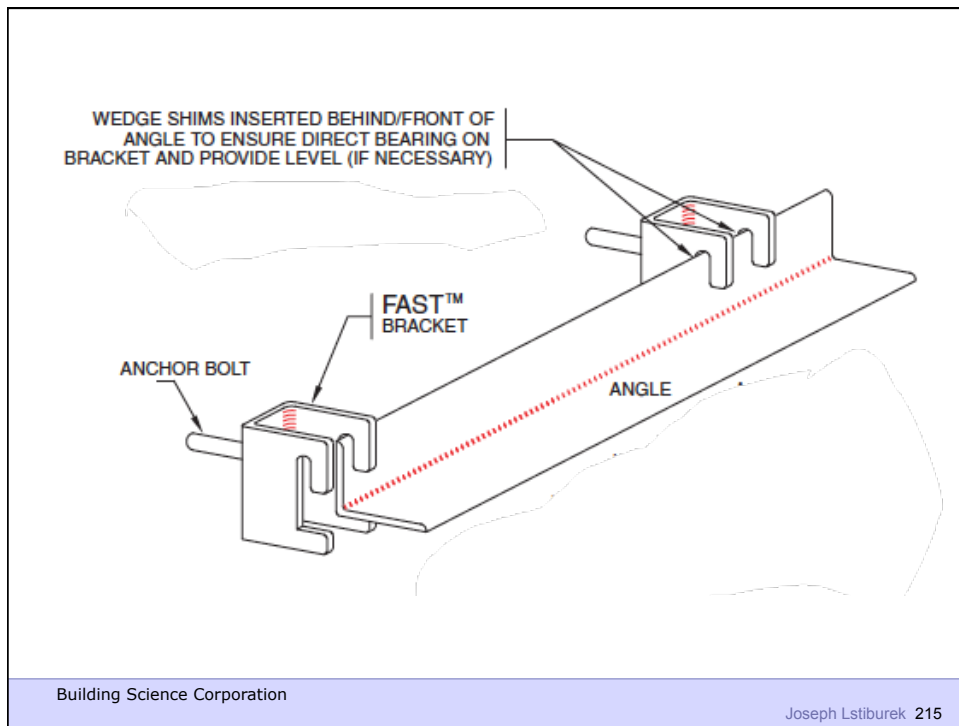



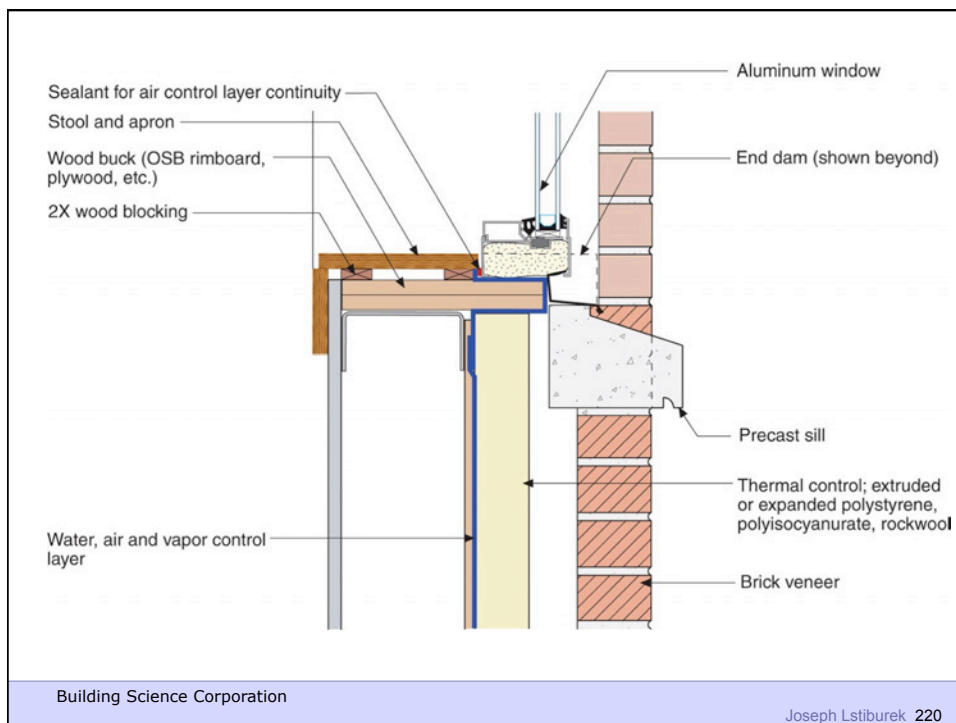
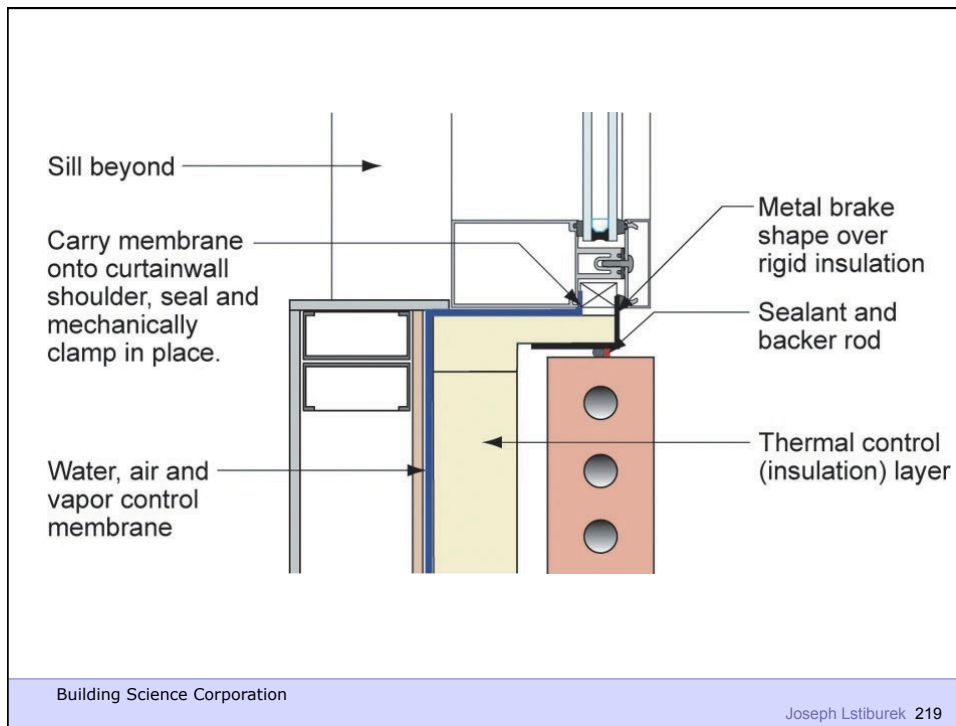

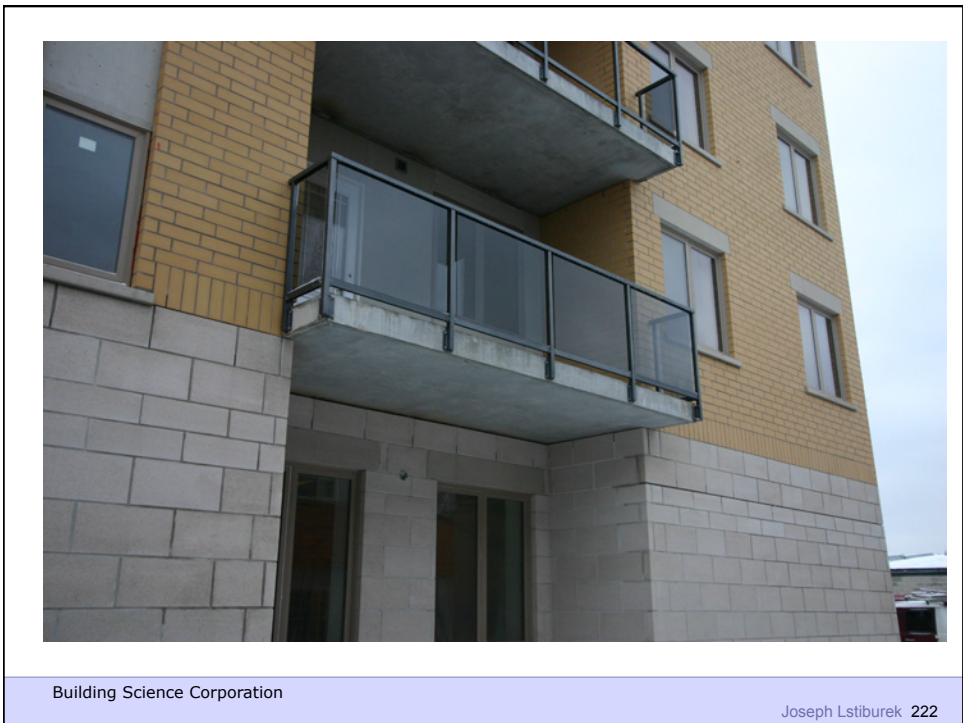
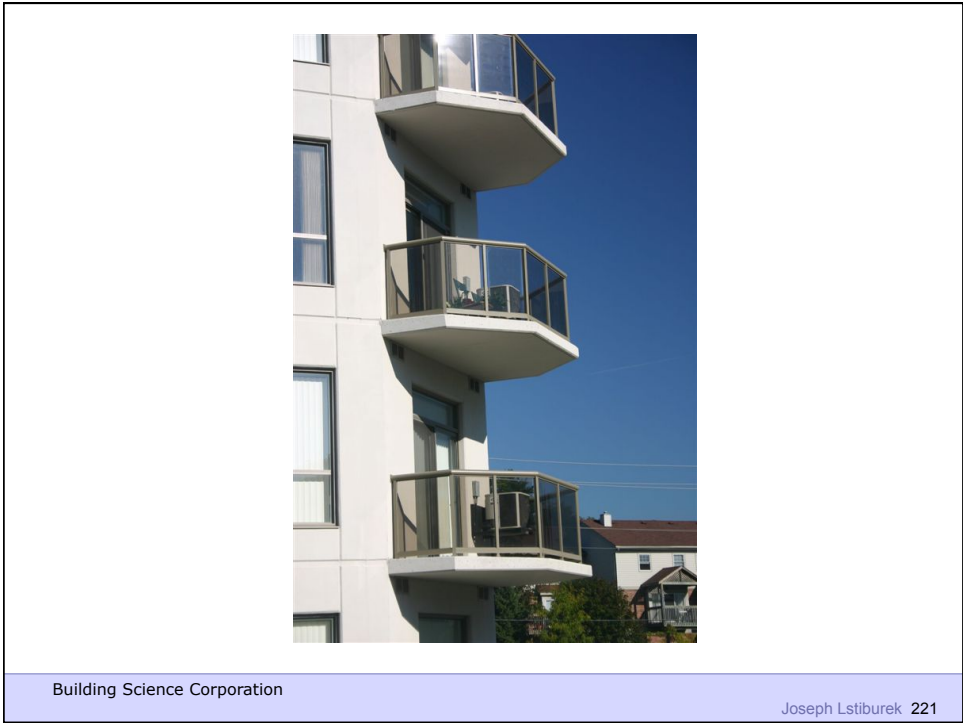



Building Science Corporation

Joseph Lstiburek 223



Building Science Corporation

Joseph Lstiburek 224

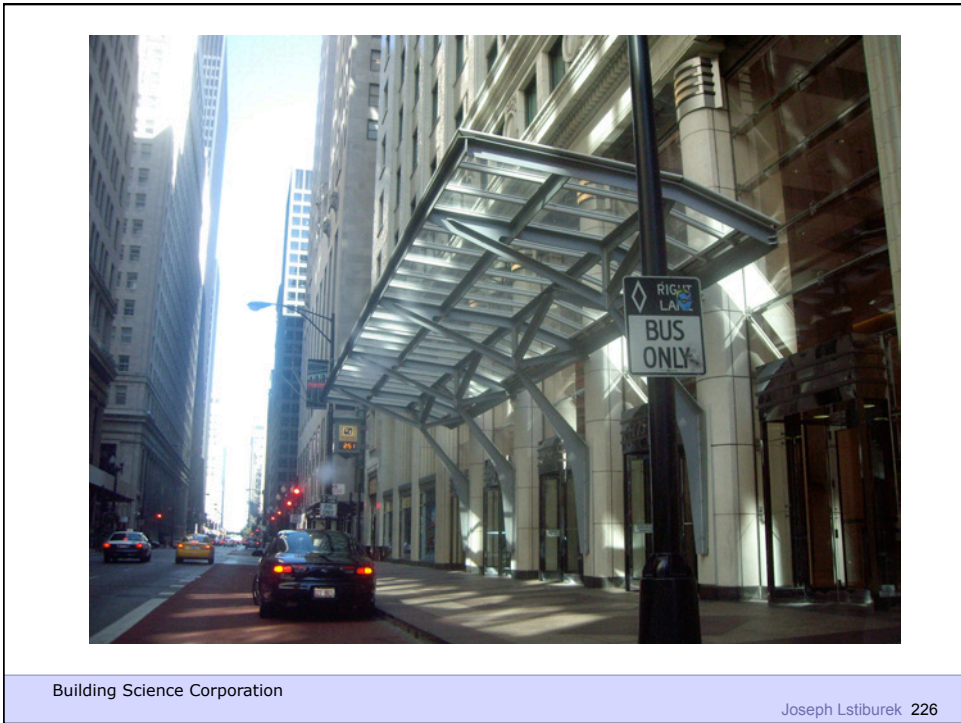





Building Science Corporation

Joseph Lstiburek 229



Building Science Corporation

Joseph Lstiburek 230

