

Joseph Lstiburek, Ph.D., P.Eng, ASHRAE Fellow

Building Science

Adventures In Building Science

www.buildingscience.com

"It isn't what we don't know that gives us trouble, it's what we know that ain't so"

Will Rogers

"There are known knowns. These are things we know. There are known unknowns. There are things that we know we don't know. But there are also unknown unknowns. There are things we don't know we don't know.

Donald Rumsfeld

Building Science Corporation Joseph Lstiburek 2

What is a Building?

Building Science Corporation Joseph Lstiburek 3

A Building is an Environmental Separator

Building Science Corporation Joseph Lstiburek 4

- Control heat flow
- Control airflow
- Control water vapor flow
- Control rain
- Control ground water
- Control light and solar radiation
- Control noise and vibrations
- Control contaminants, environmental hazards and odors
- Control insects, rodents and vermin
- Control fire
- Provide strength and rigidity
- Be durable
- Be aesthetically pleasing
- Be economical

Building Science Corporation

Joseph Lstiburek 5

Zeroth Law – $A=B$ and $B=C$ therefore $A=C$
First Law - Conservation of Energy
Second Law - Entropy
Third Law – Absolute Zero

Building Science Corporation

Joseph Lstiburek 6

2nd Law of Thermodynamics

Building Science Corporation

Joseph Lstiburek 7

In an isolated system, a process can occur only if it increases the total entropy of the system

Rudolf Clausius

Building Science Corporation

Joseph Lstiburek 8

Heat Flow Is From Warm To Cold
Moisture Flow Is From Warm To Cold
Moisture Flow Is From More To Less
Air Flow Is From A Higher Pressure to a
Lower Pressure
Gravity Acts Down

Building Science Corporation

Joseph Lstiburek 9

Moisture Flow Is From Warm To Cold
Moisture Flow Is From More To Less

Building Science Corporation

Joseph Lstiburek 10

Moisture Flow Is From Warm To Cold
Moisture Flow Is From More To Less

Thermal Gradient – Thermal Diffusion
Concentration Gradient – Molecular Diffusion

Building Science Corporation

Joseph Lstiburek 11

Moisture Flow Is From Warm To Cold
Moisture Flow Is From More To Less

Thermal Gradient – Thermal Diffusion
Concentration Gradient – Molecular Diffusion

Vapor Diffusion

Building Science Corporation

Joseph Lstiburek 12

Thermodynamic Potential

Building Science Corporation Joseph Lstiburek 13

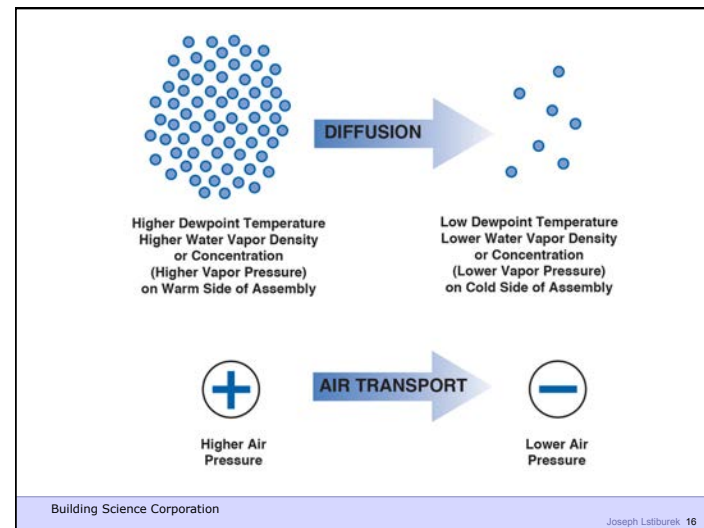
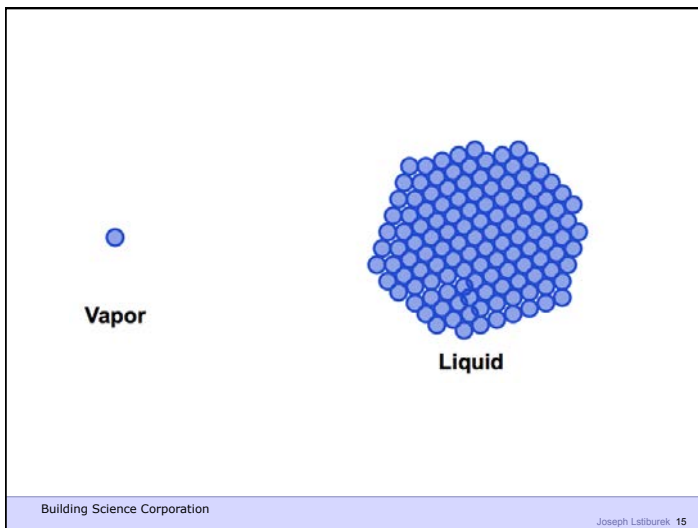
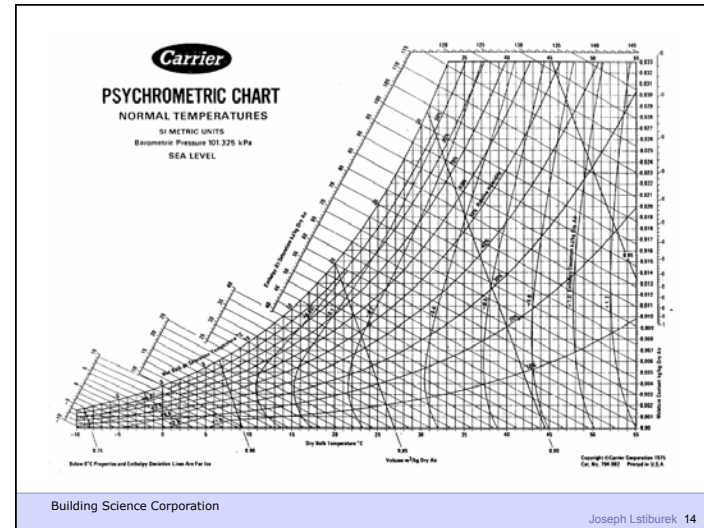

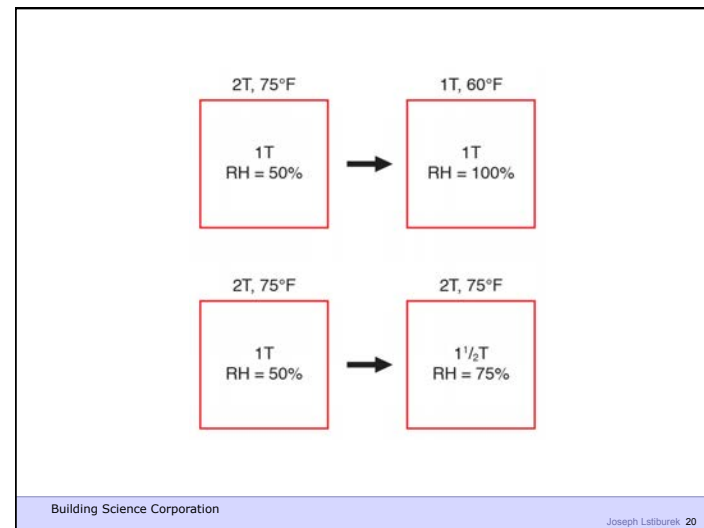
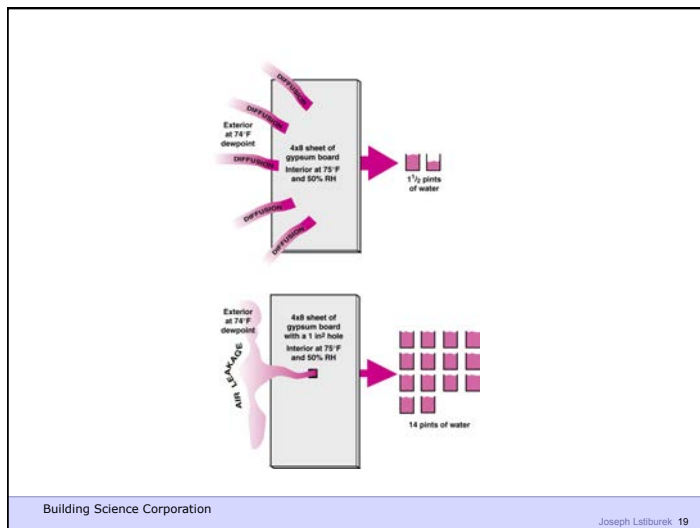
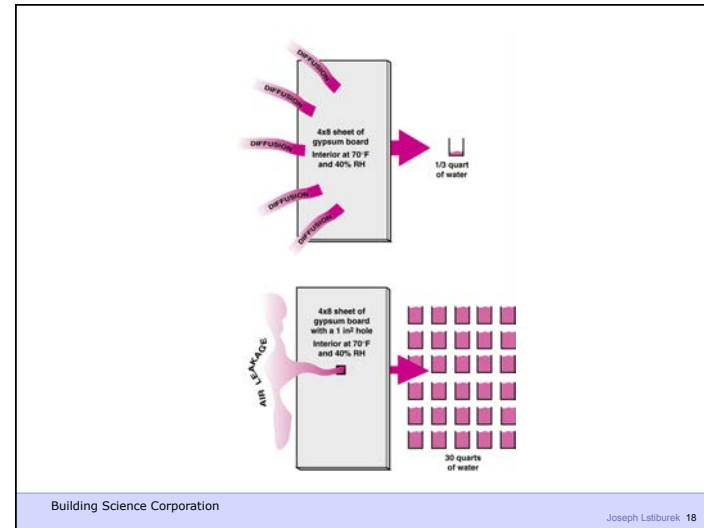
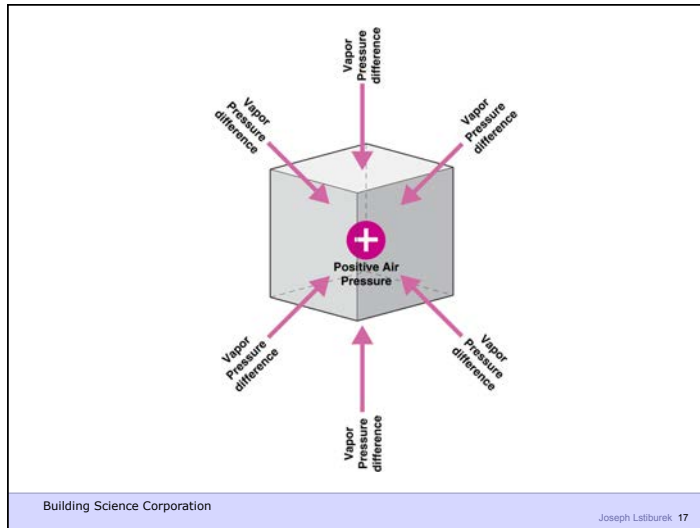

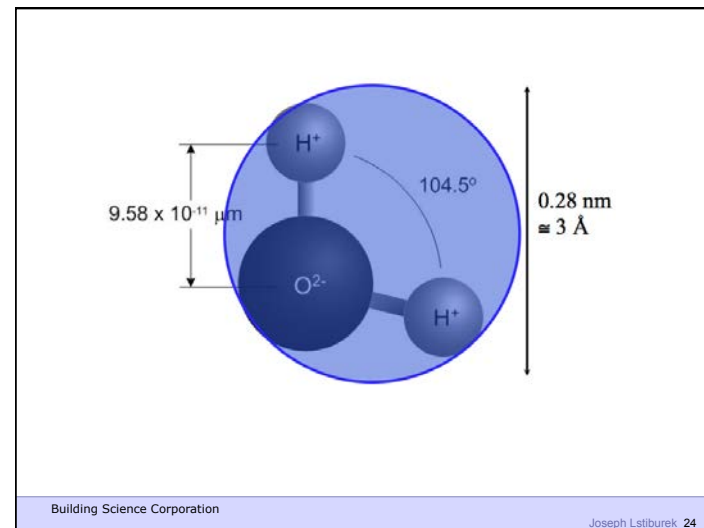
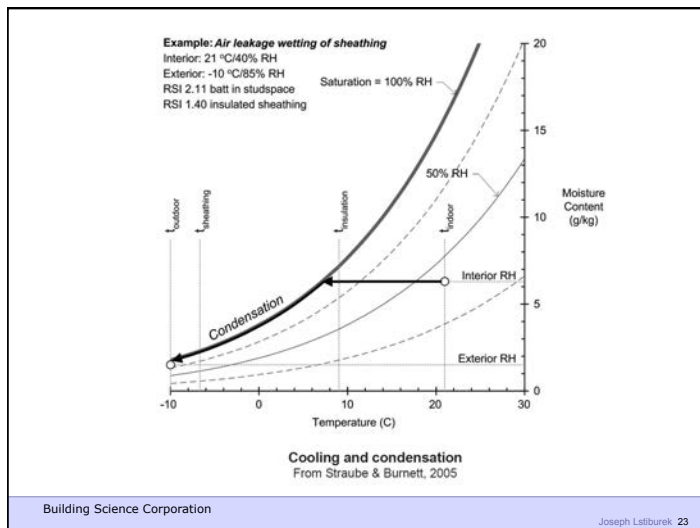
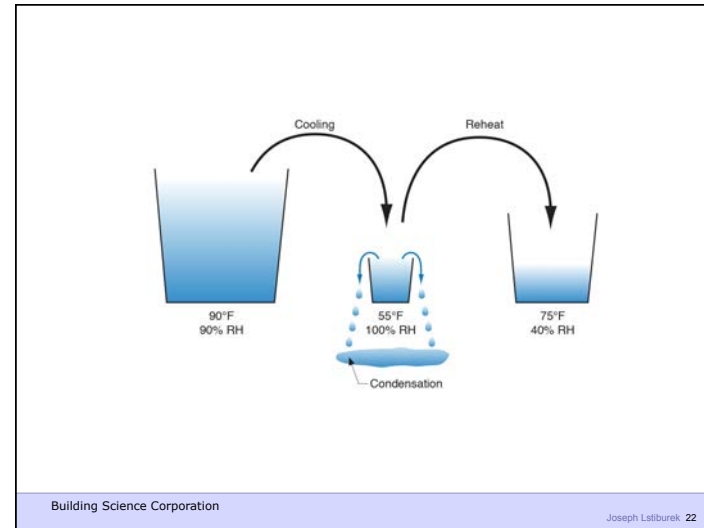
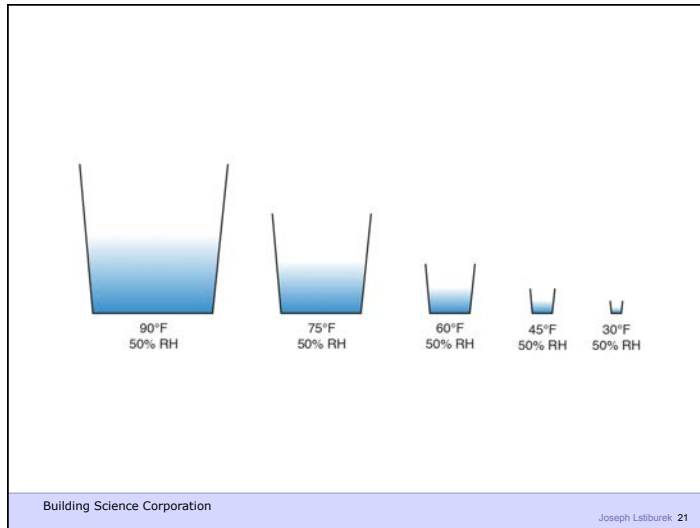

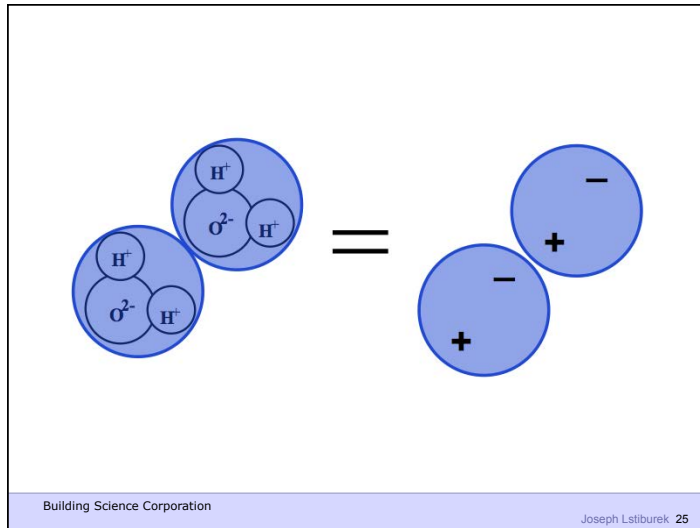

Damage Functions

Building Science Corporation Joseph Lstiburek 26

Damage Functions
Water
Heat
Ultra Violet Radiation

Building Science Corporation Joseph Lstiburek 27

Damage Functions
Water
Heat
Ultra Violet Radiation
Oxidization (Ozone)
Fatigue (Creep)

Building Science Corporation Joseph Lstiburek 28

The Three Biggest Problems In Buildings Are
Water, Water and Water...

Building Science Corporation Joseph Lstiburek 29

Heat
Air
Moisture

Building Science Corporation Joseph Lstiburek 30

HAM

Building Science Corporation Joseph Lstiburek 31

Hygrothermal Analysis

Building Science Corporation Joseph Lstiburek 32

Water Control Layer
Air Control Layer
Vapor Control Layer
Thermal Control Layer

Building Science Corporation Joseph Lstiburek 33

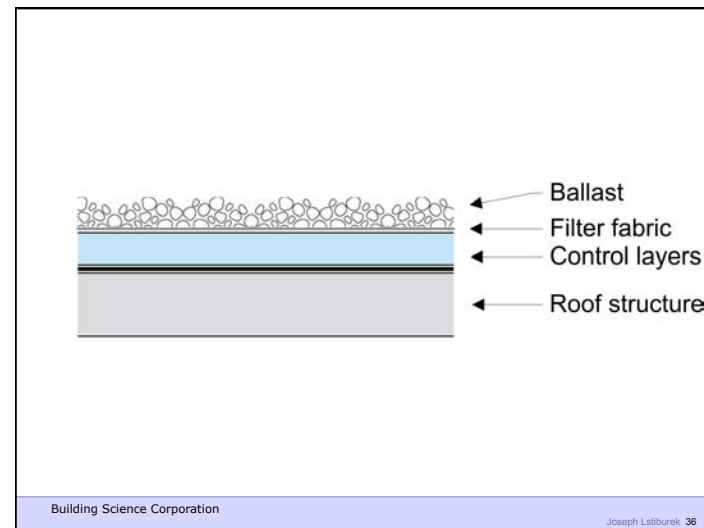
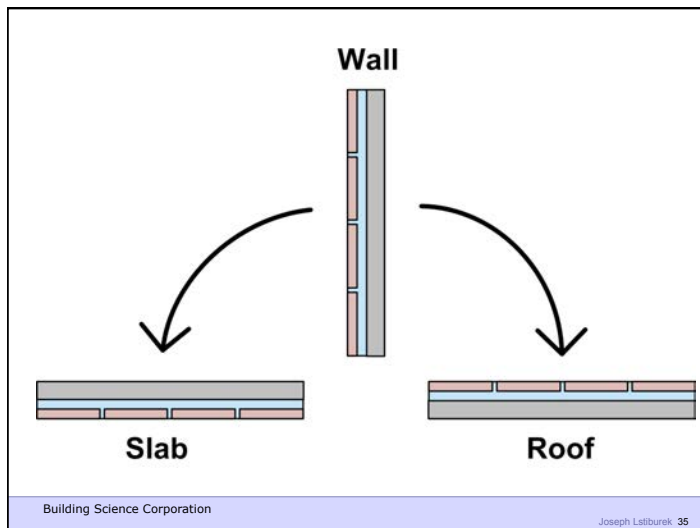
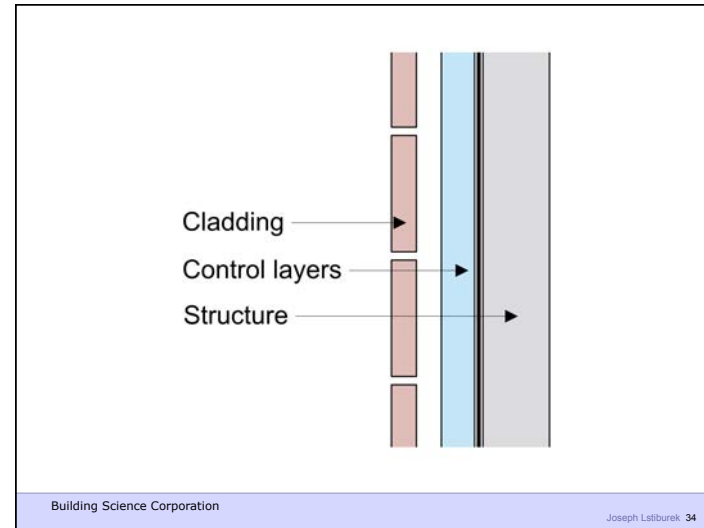

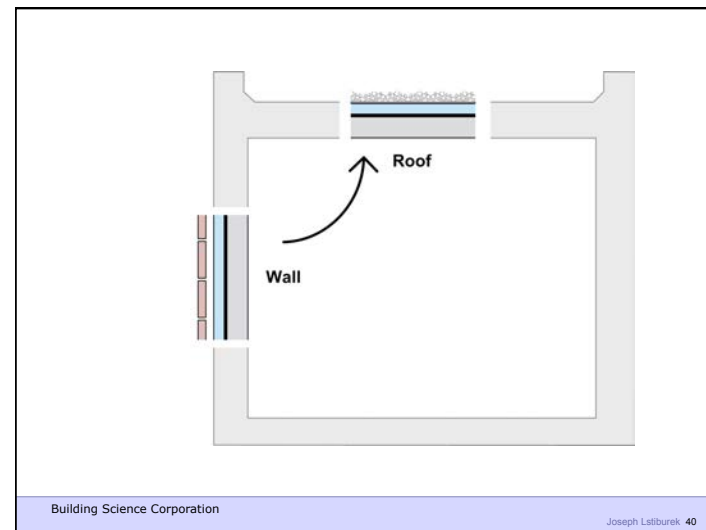
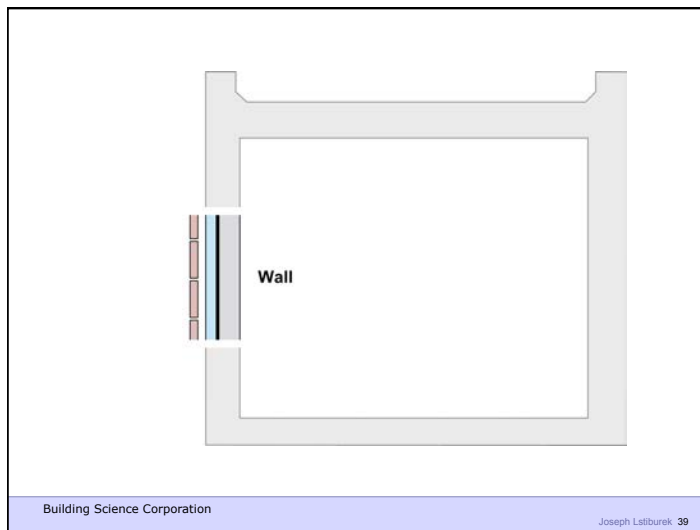
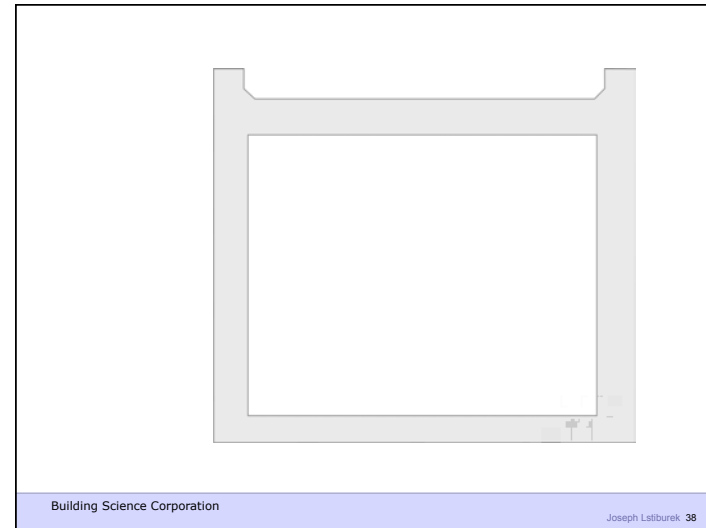
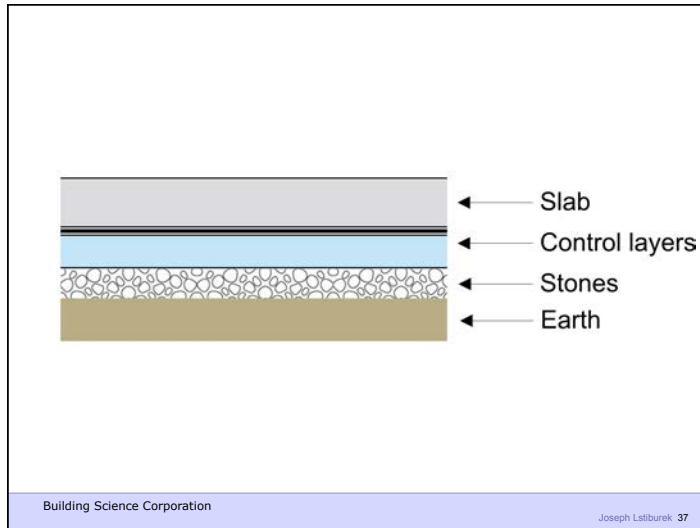

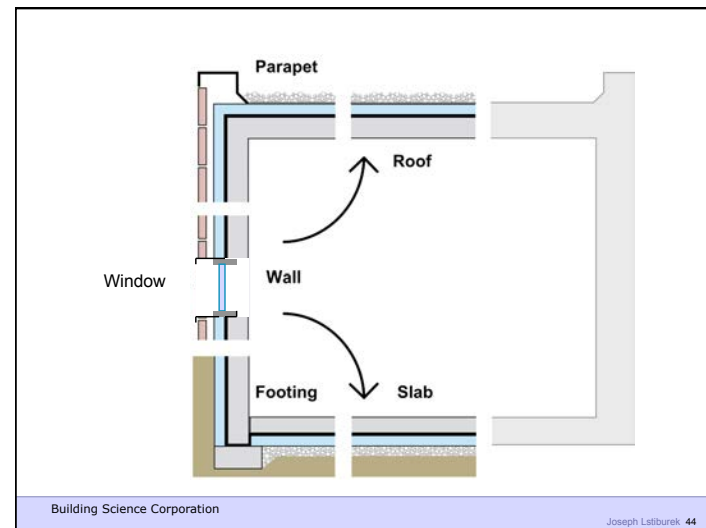
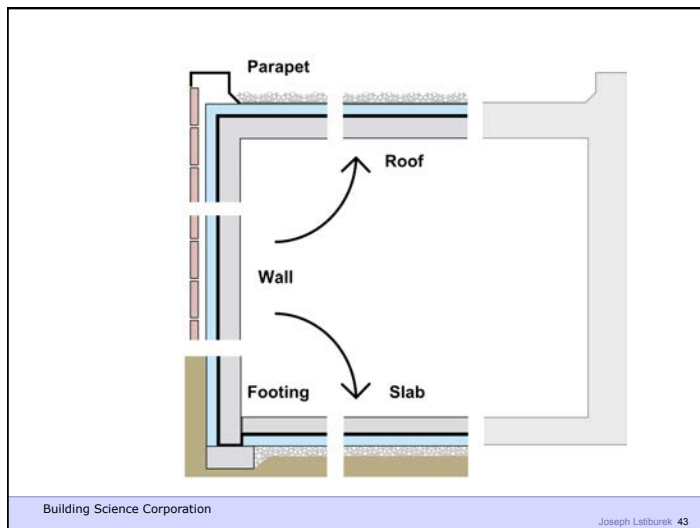
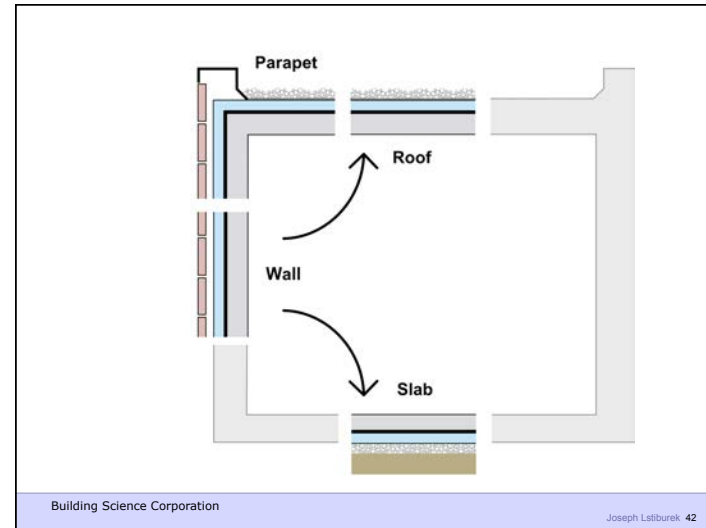
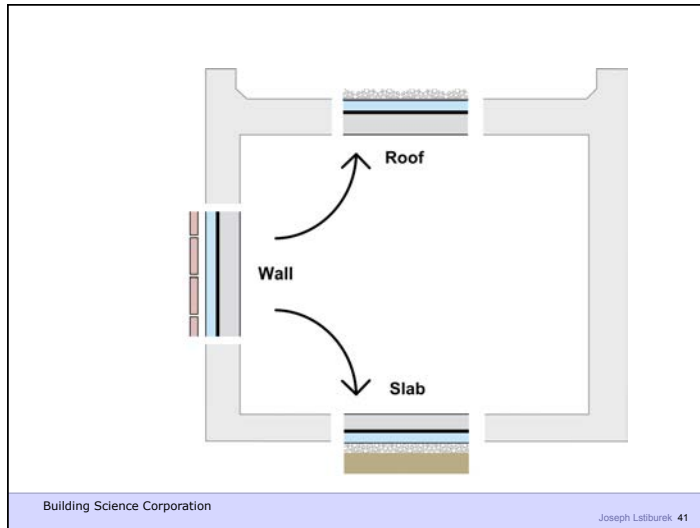

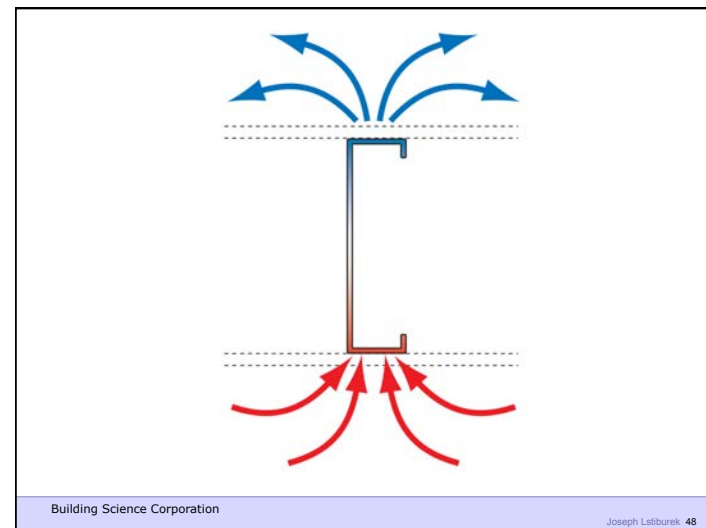
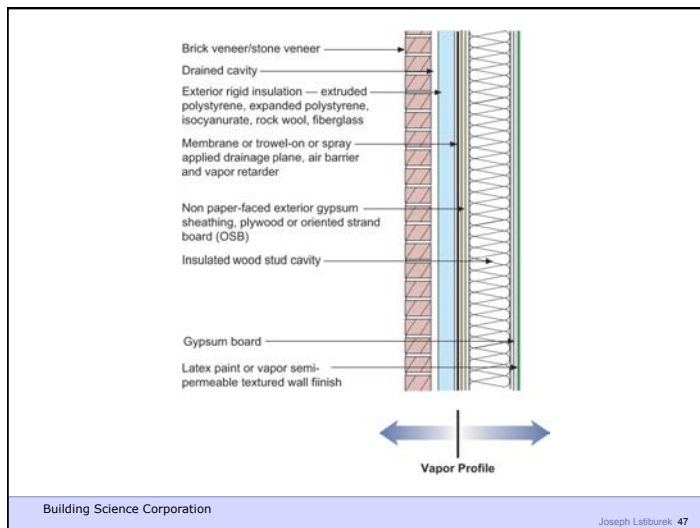
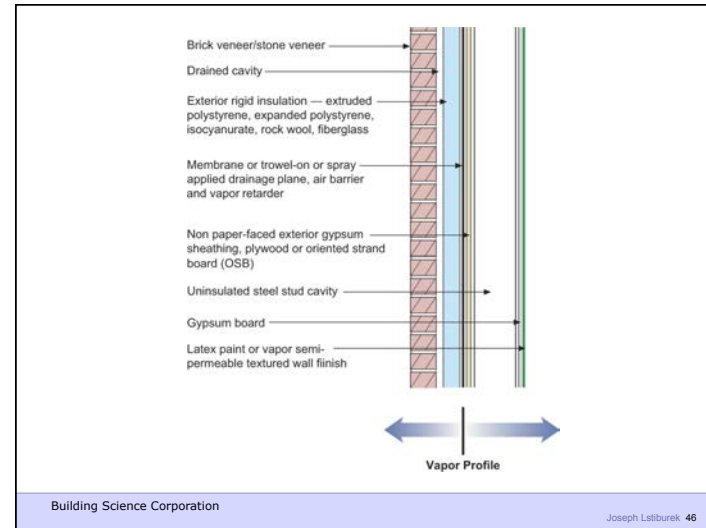
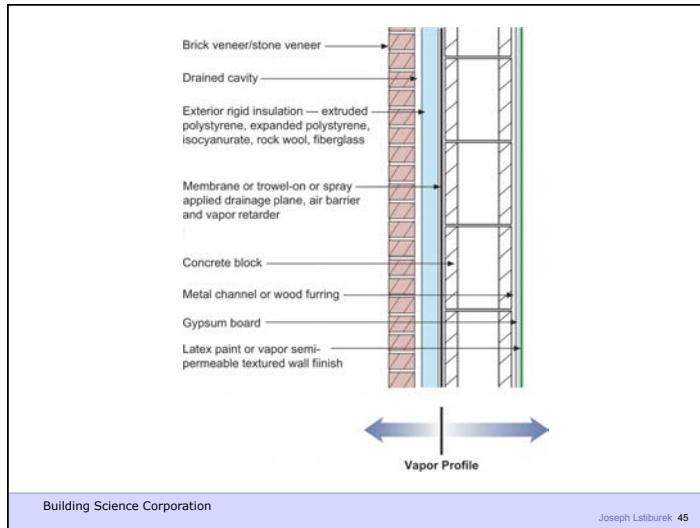



Commercial Enclosure: Simple Layers

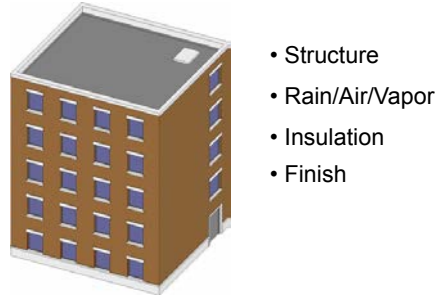

- Structure
- Rain/Air/Vapor
- Insulation
- Finish

Building Science Corporation

Joseph Lstiburek 50

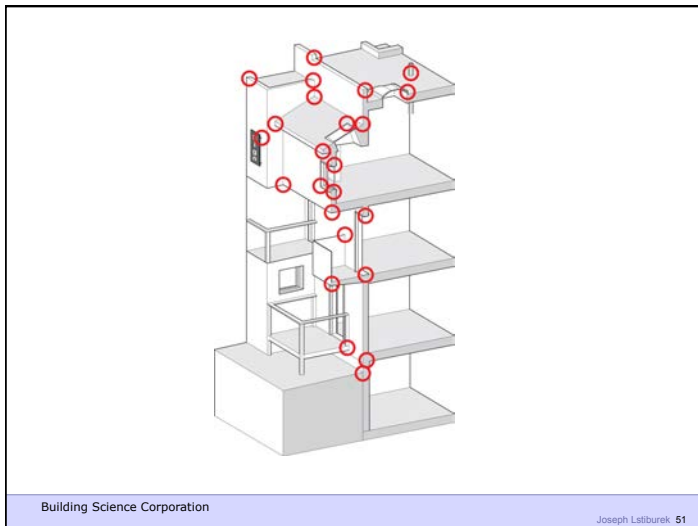

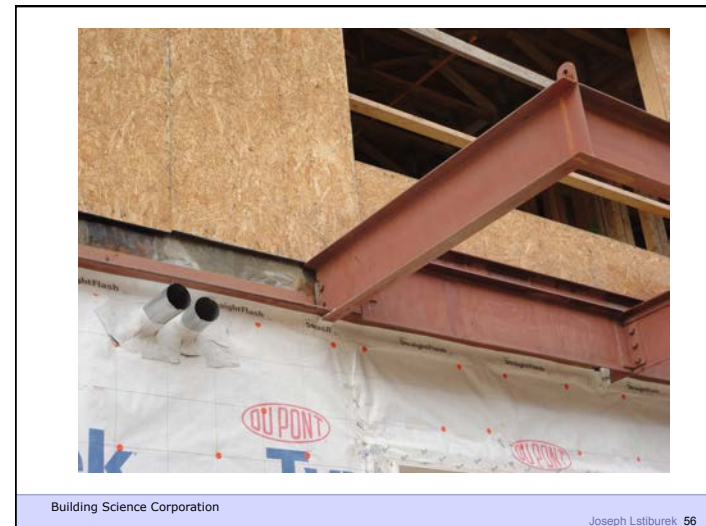
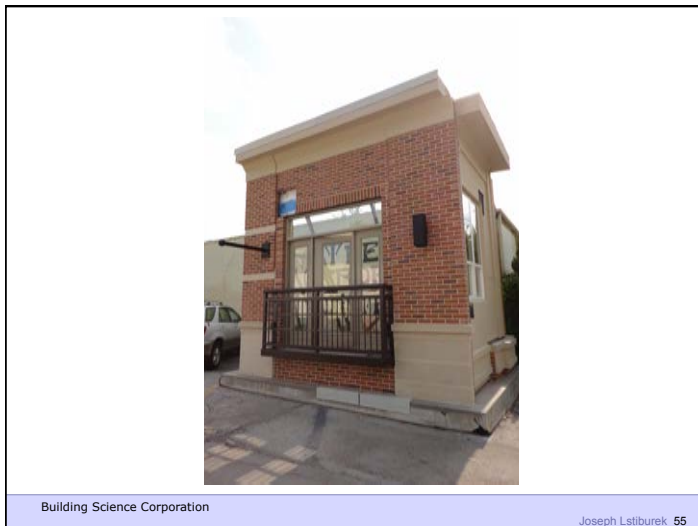

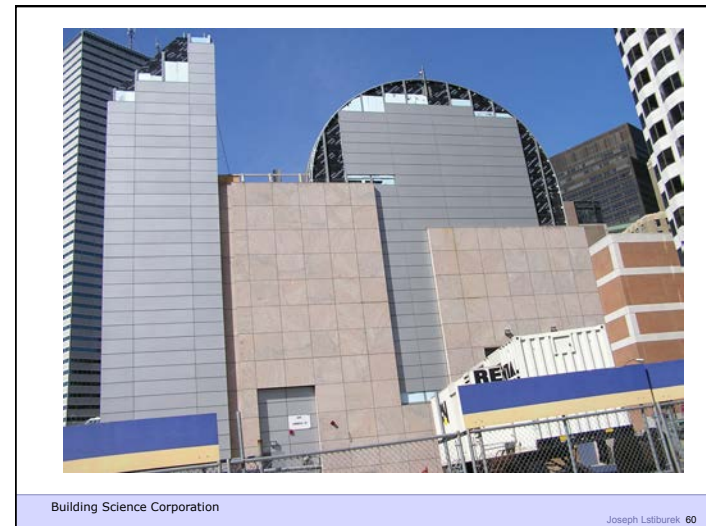
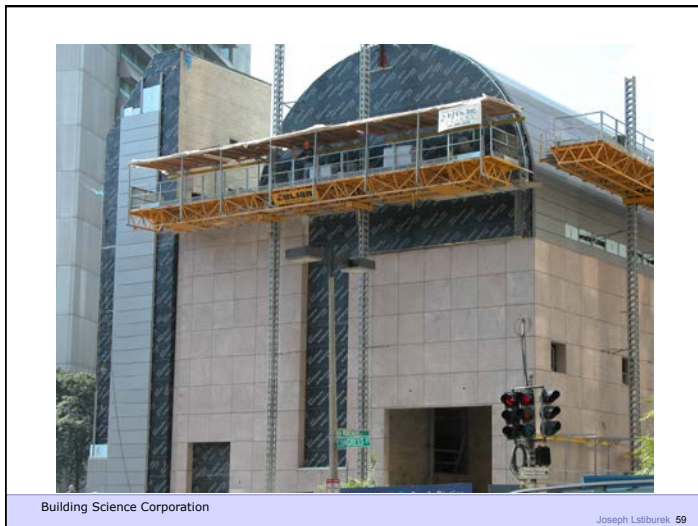

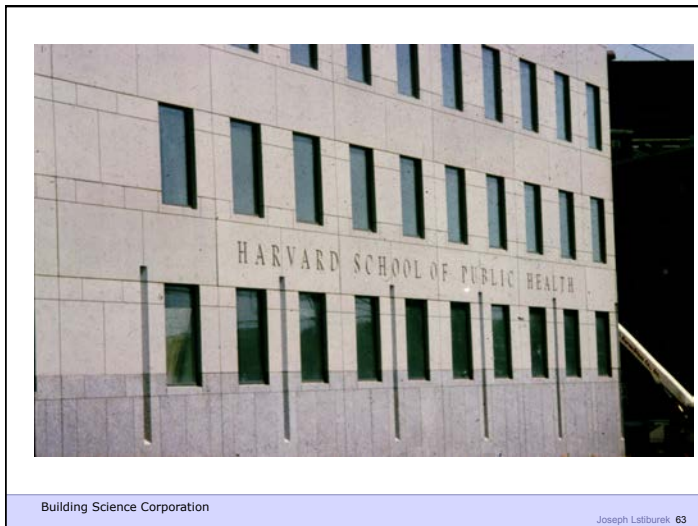
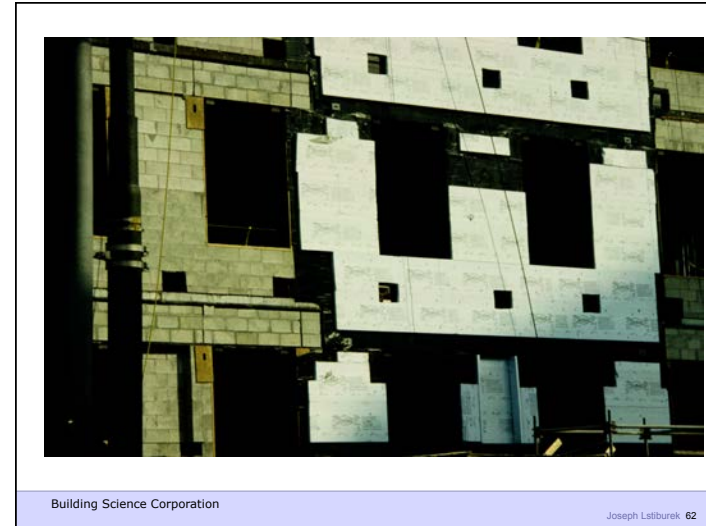

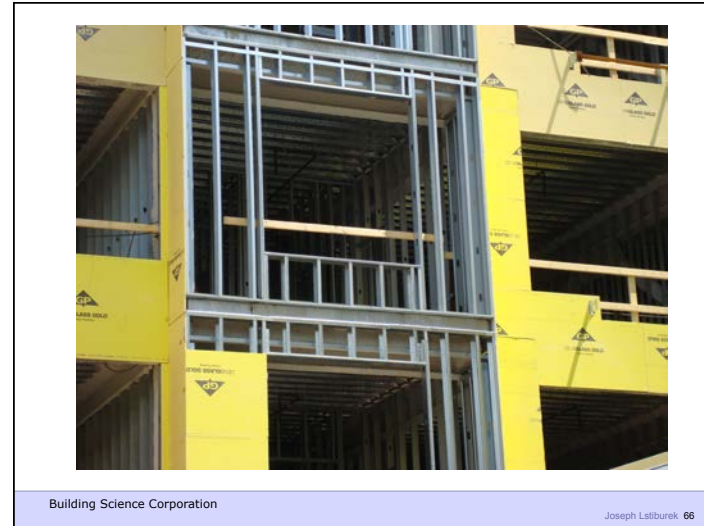

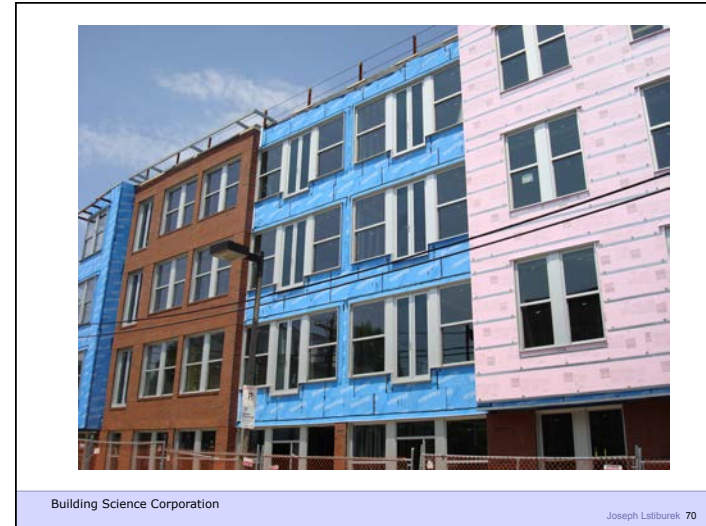
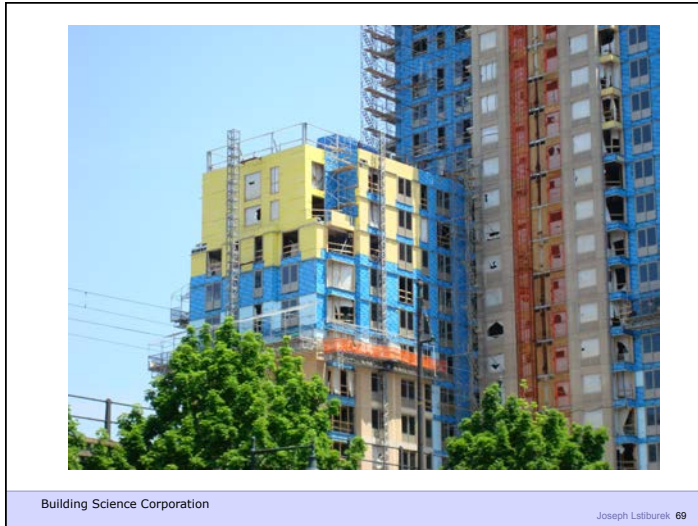





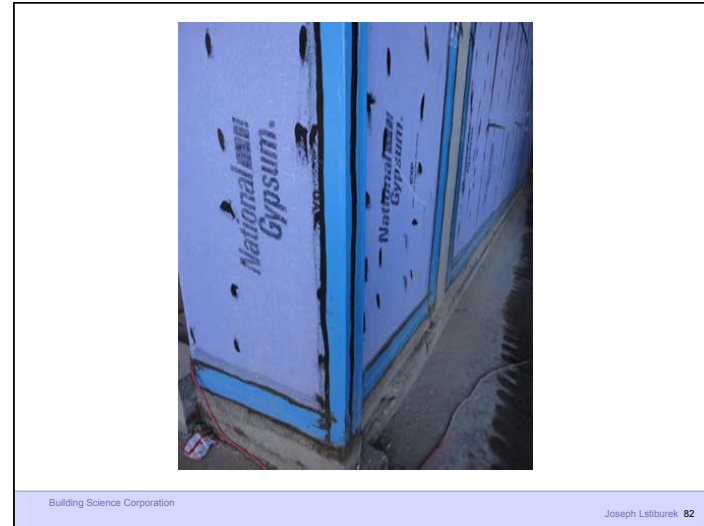

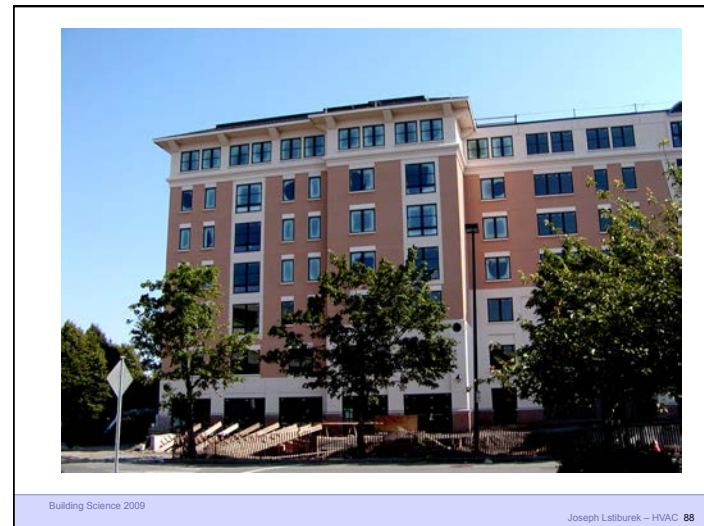
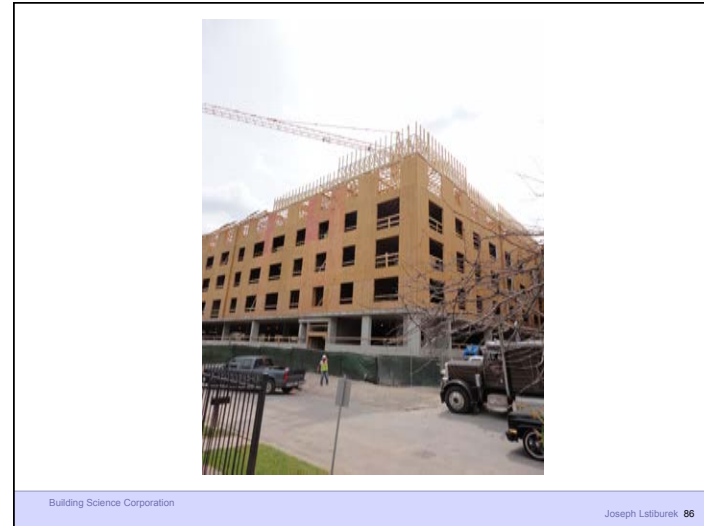

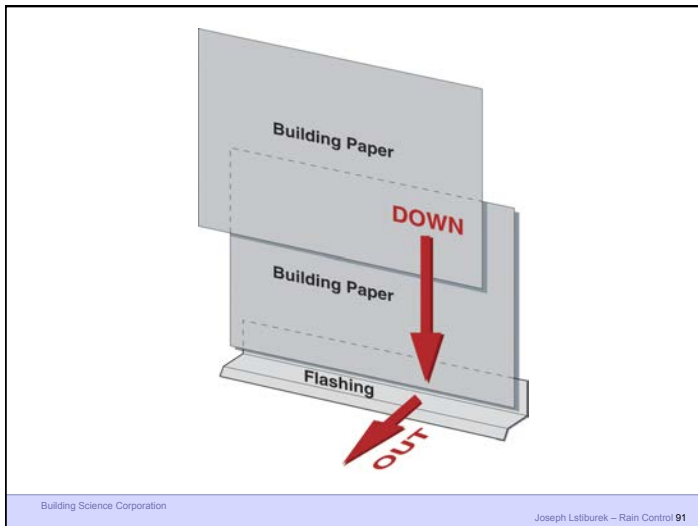
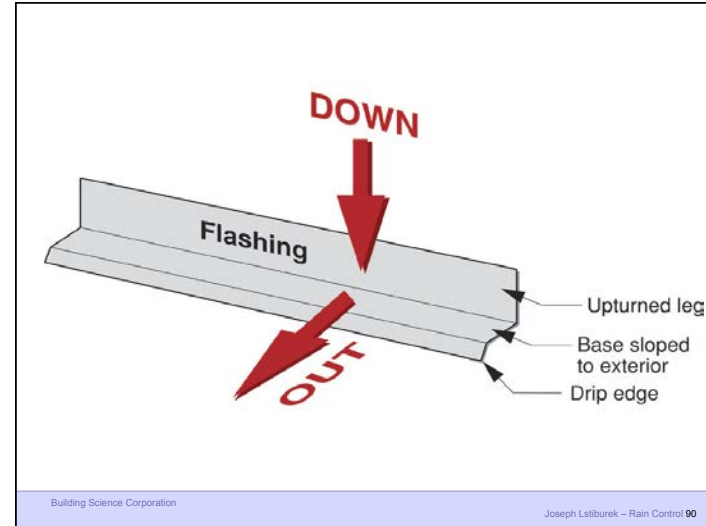

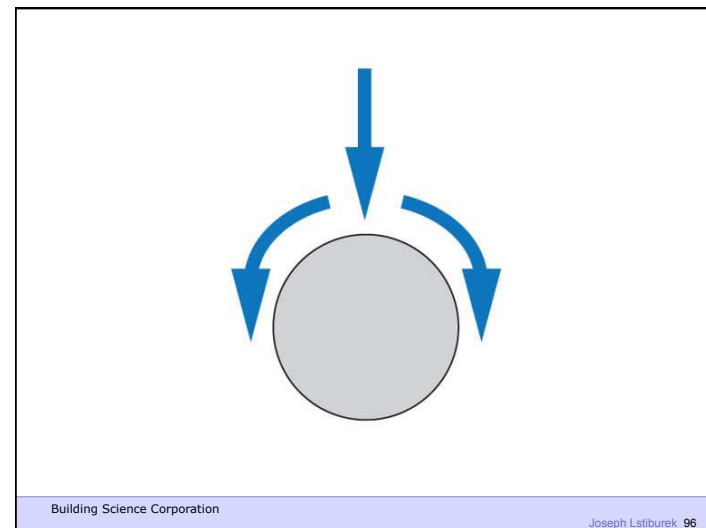
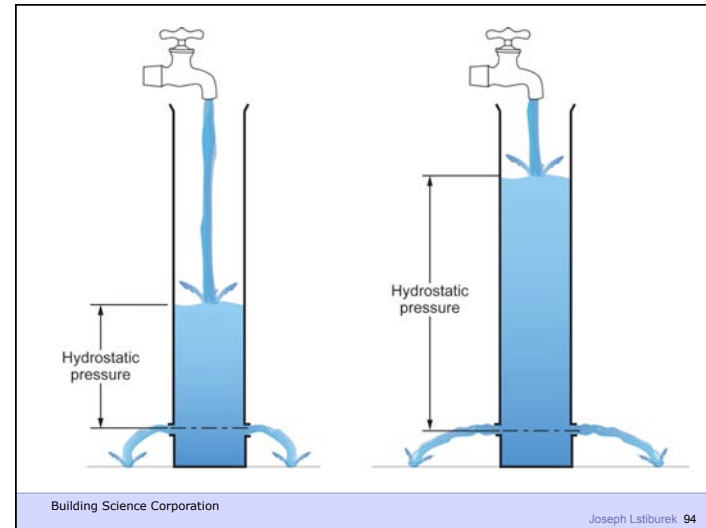

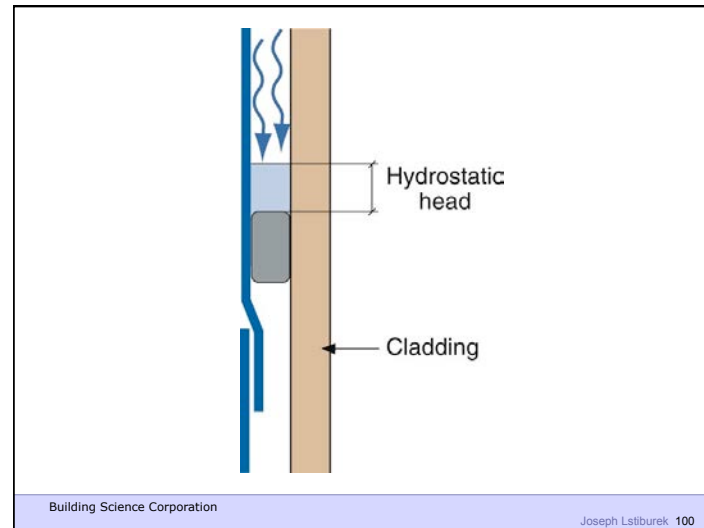
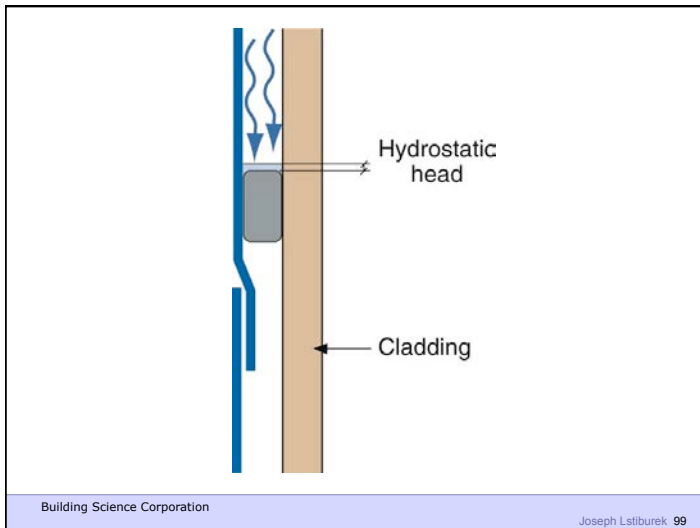
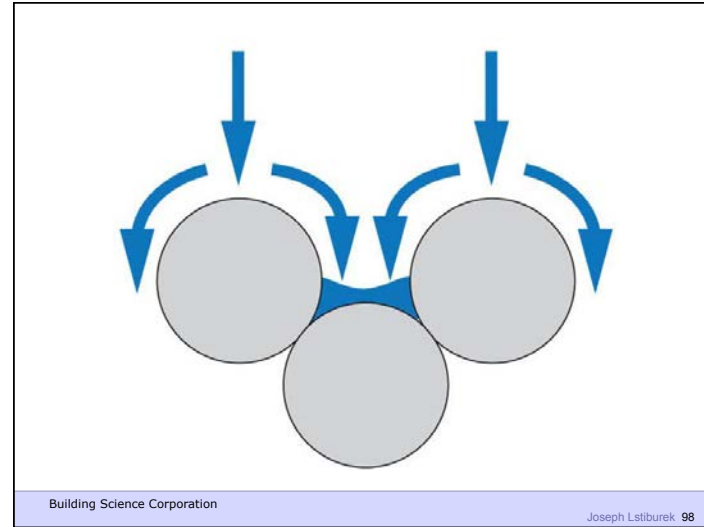
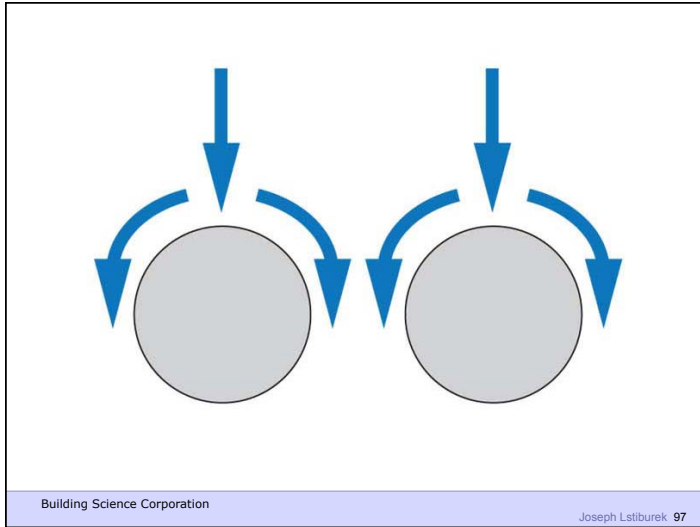

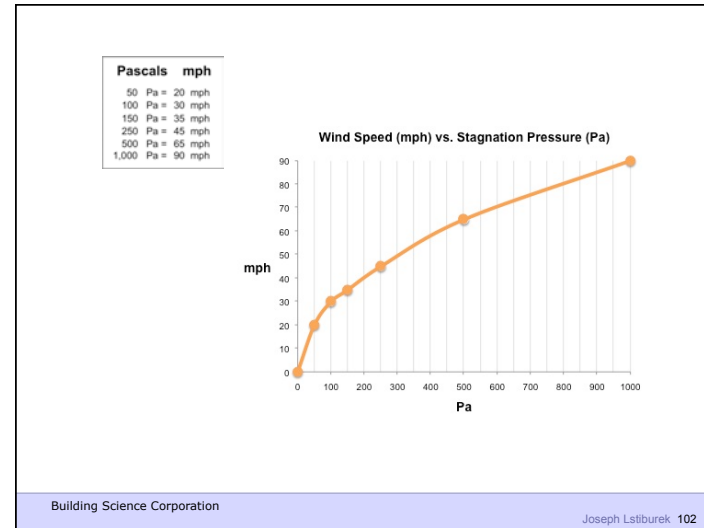
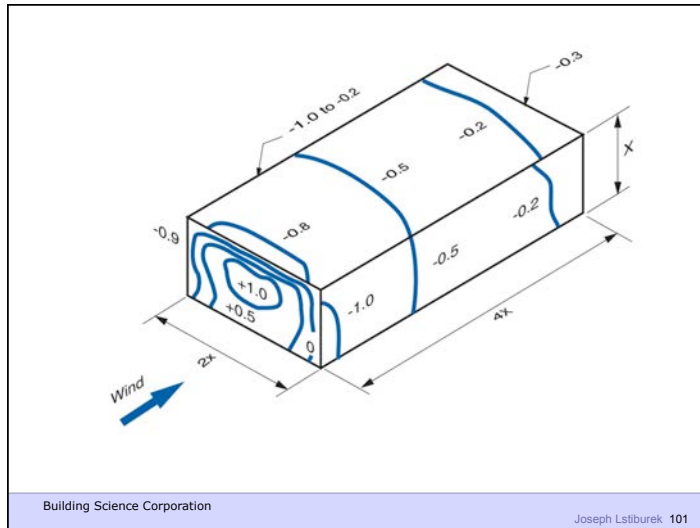

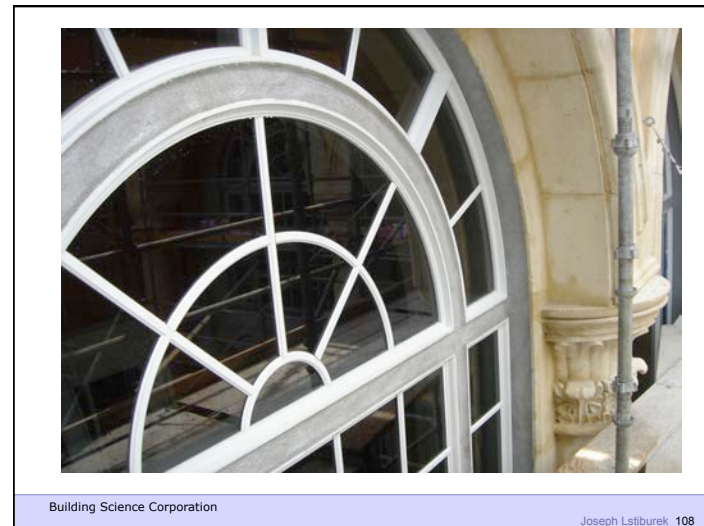

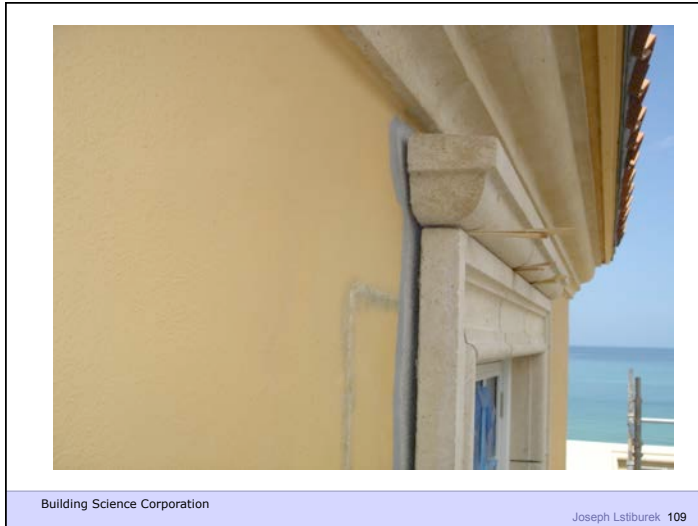

Building Science Corporation

Joseph Lstiburek 109

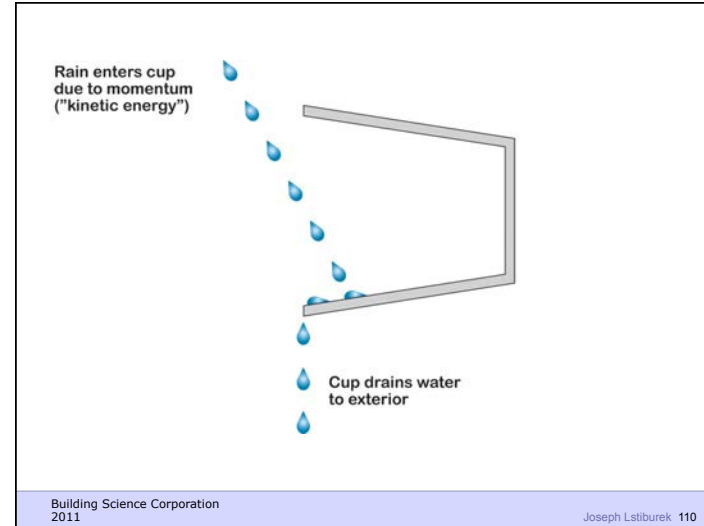

Building Science Corporation 2011

Joseph Lstiburek 110

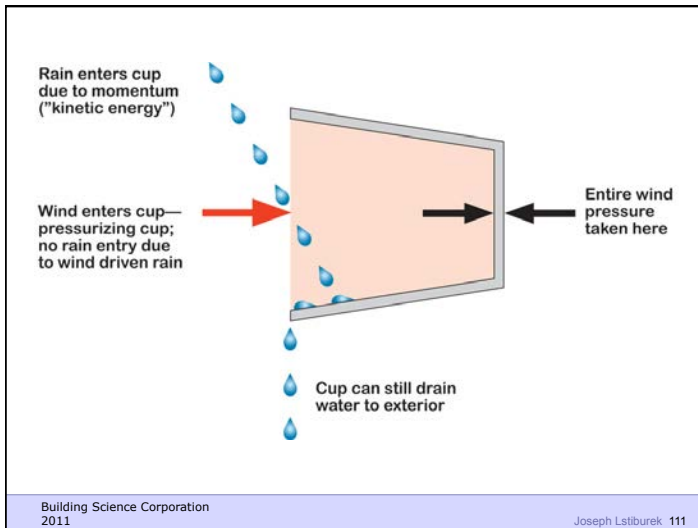

Building Science Corporation 2011

Joseph Lstiburek 111

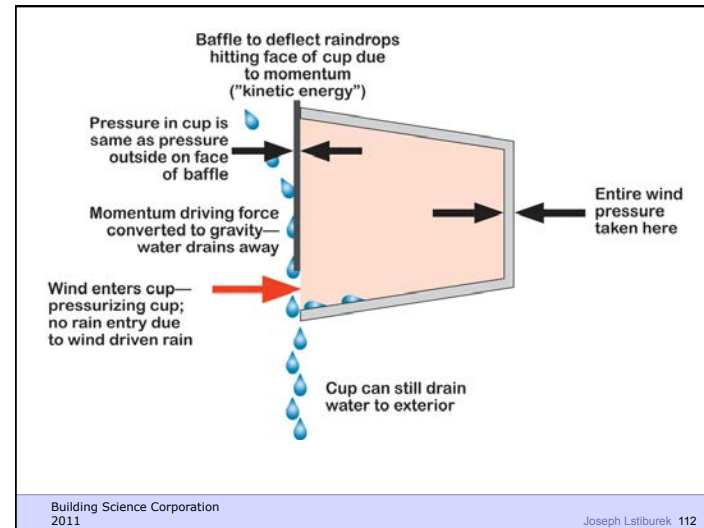

Building Science Corporation 2011

Joseph Lstiburek 112

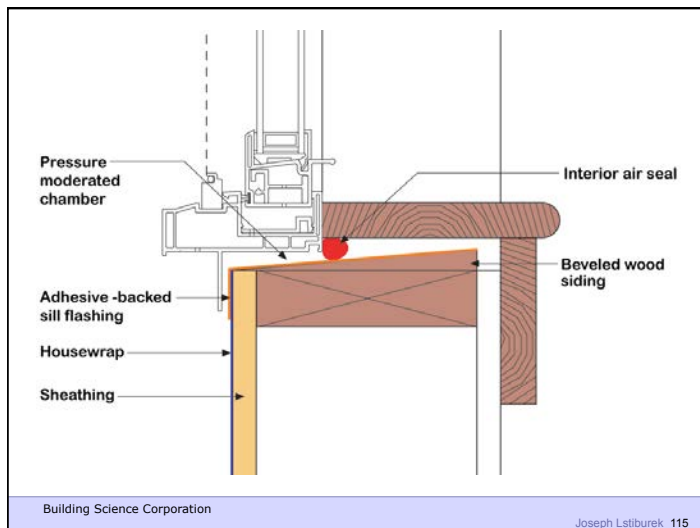
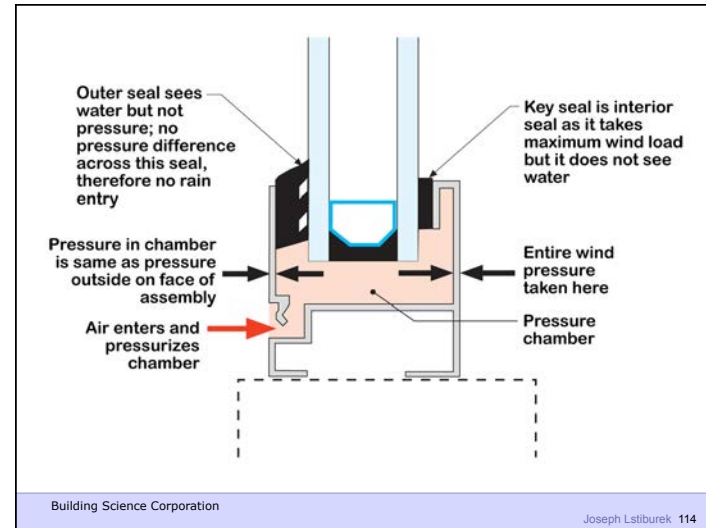
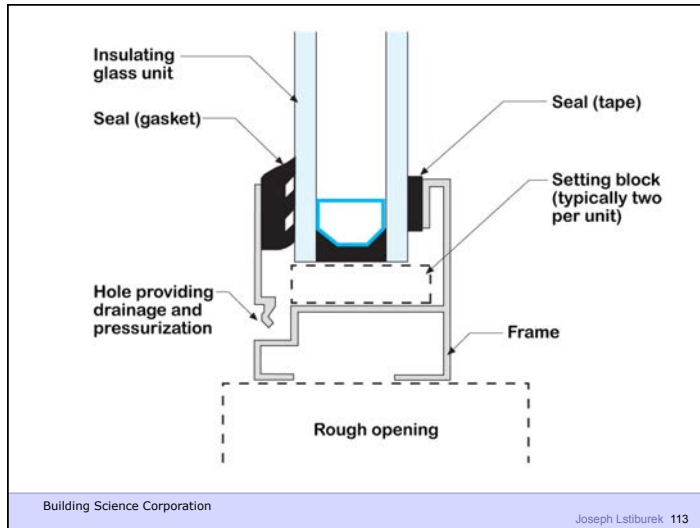

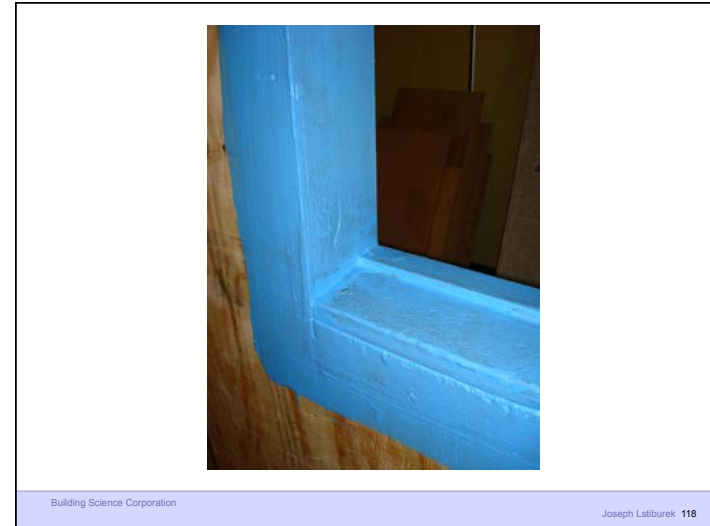

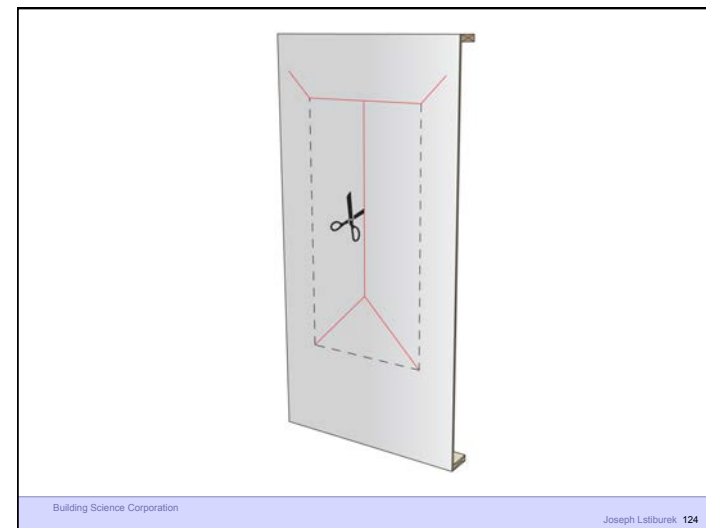
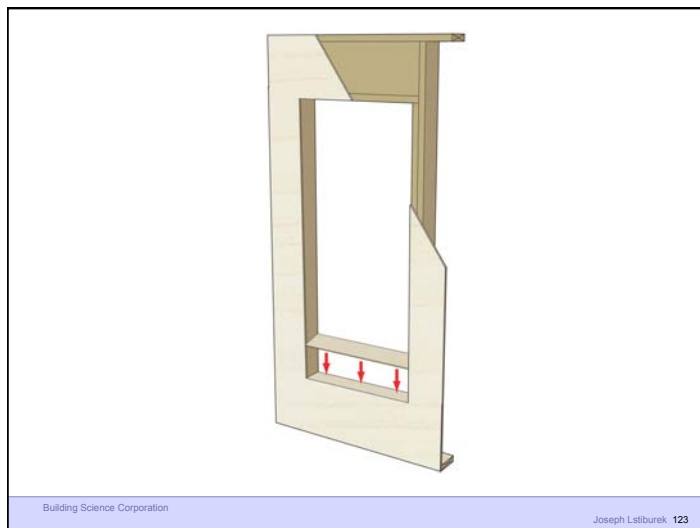
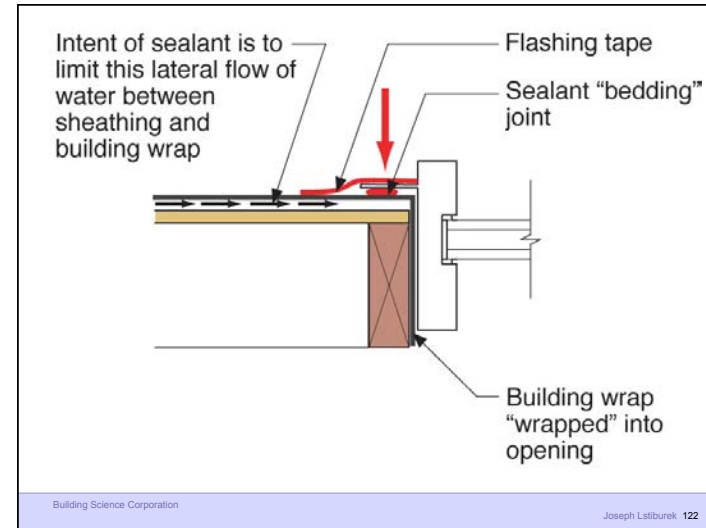

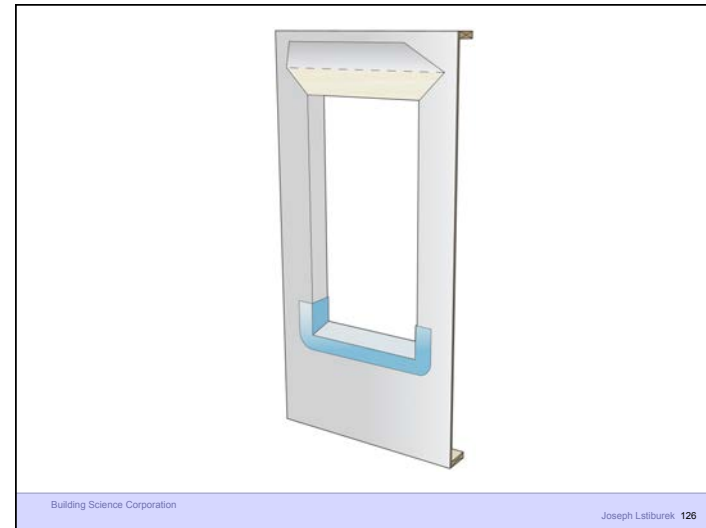
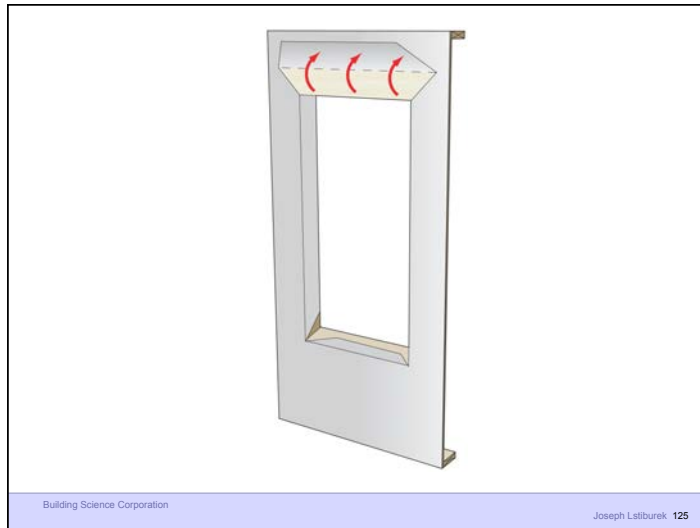



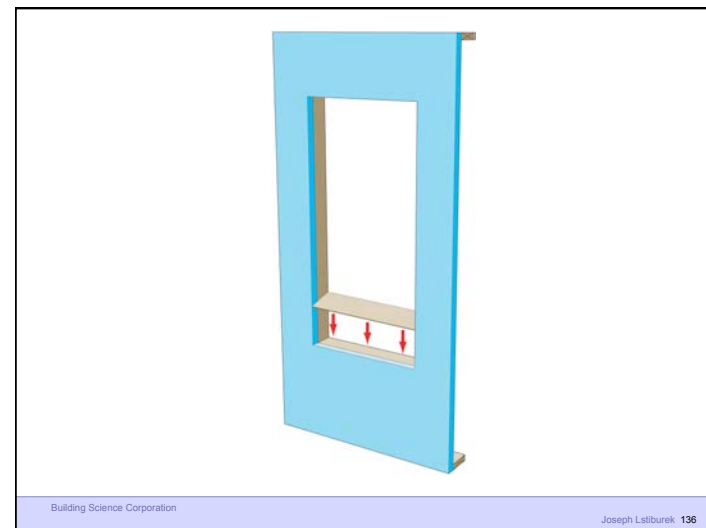
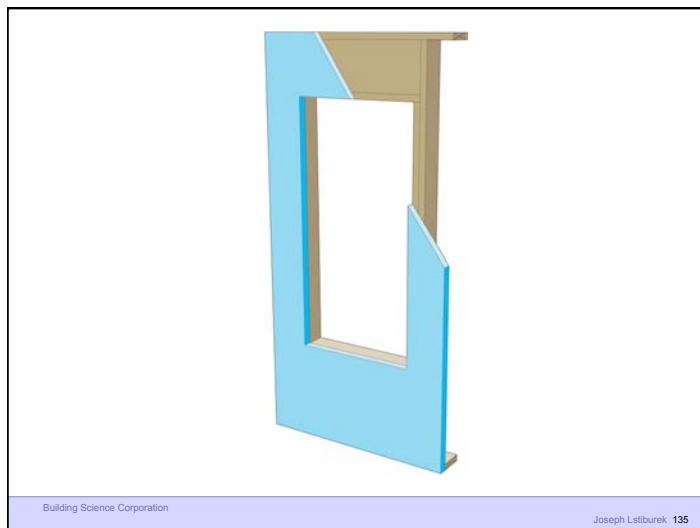
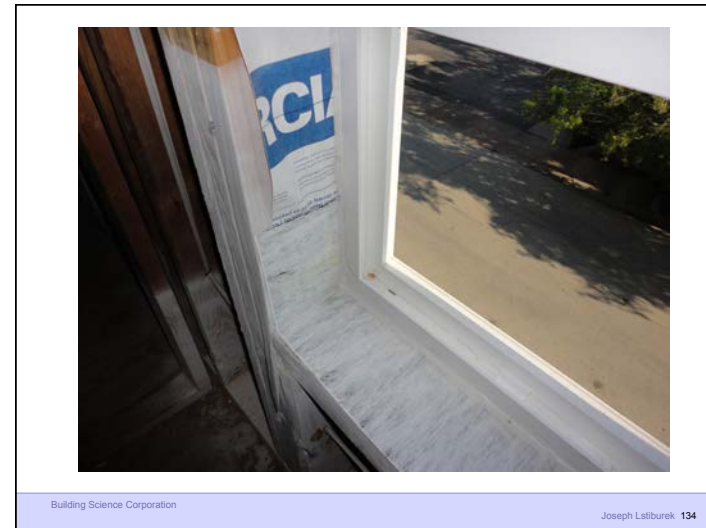

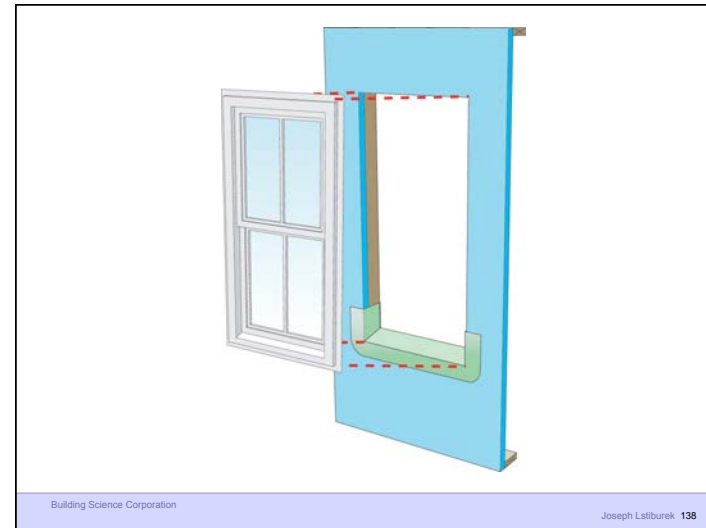
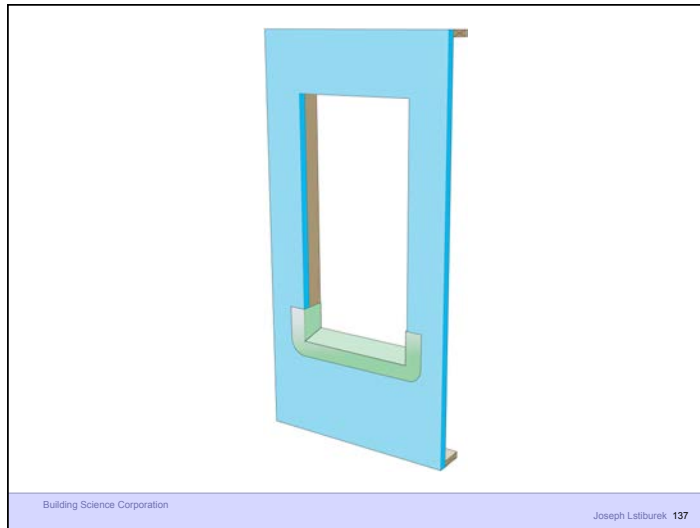



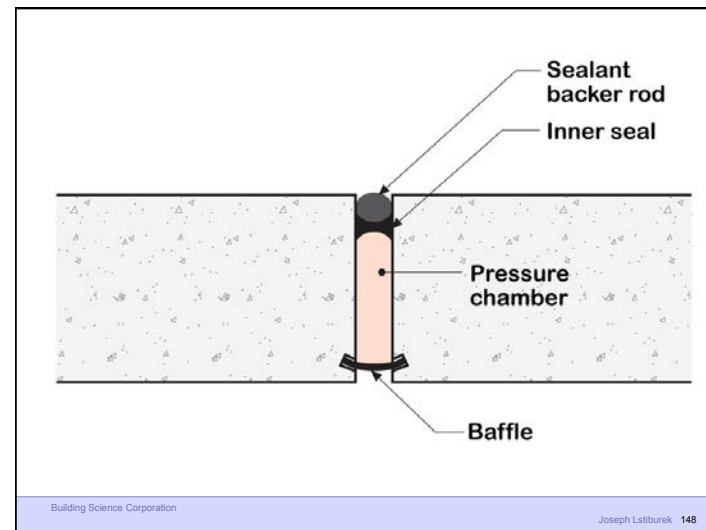
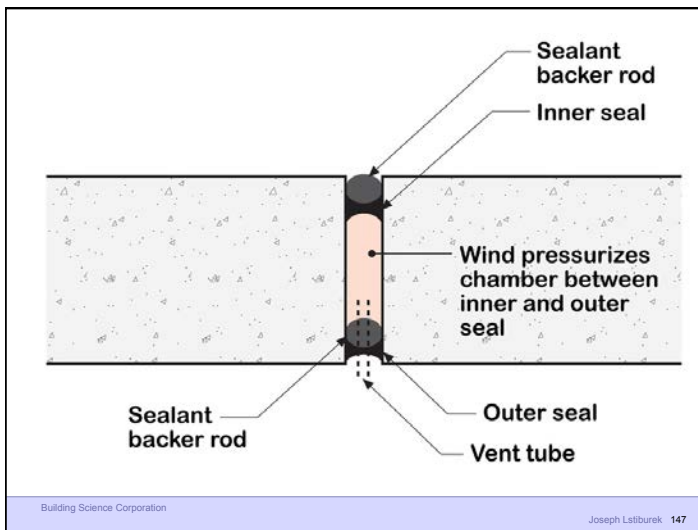
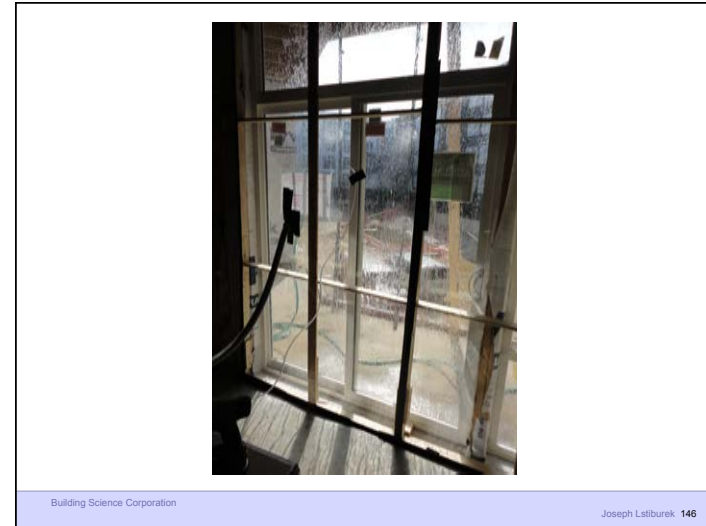

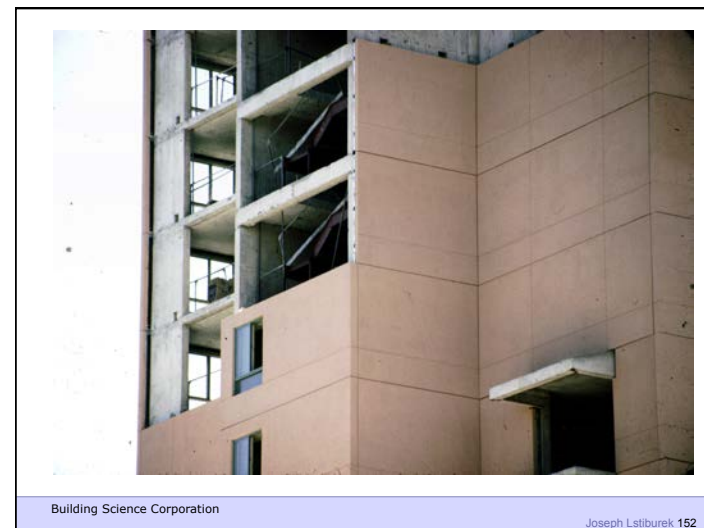
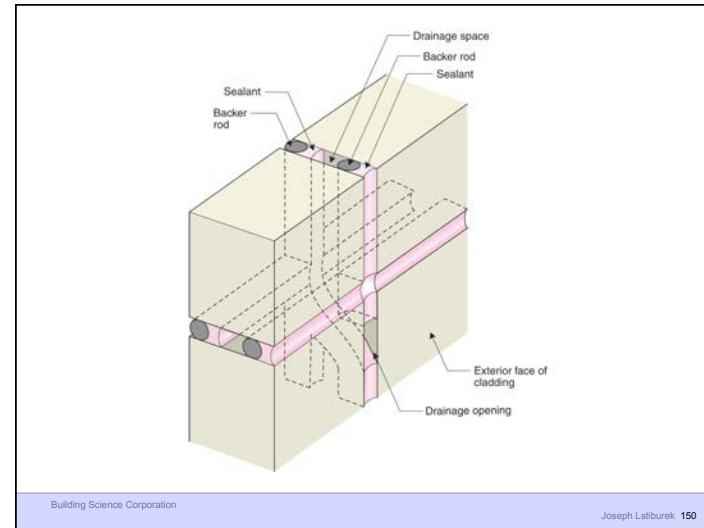
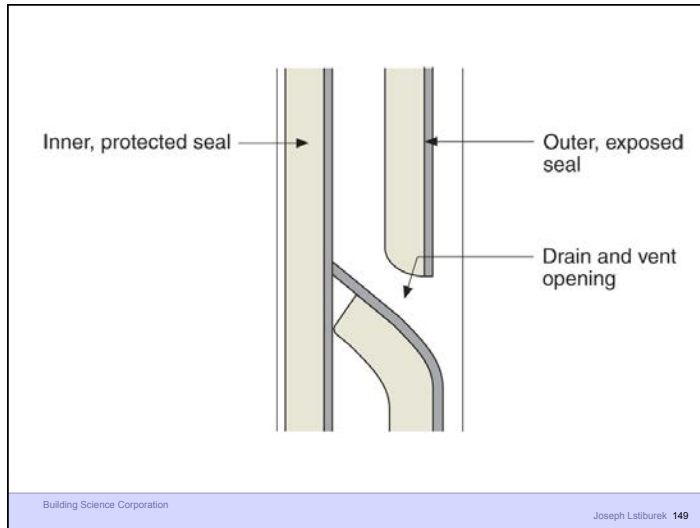

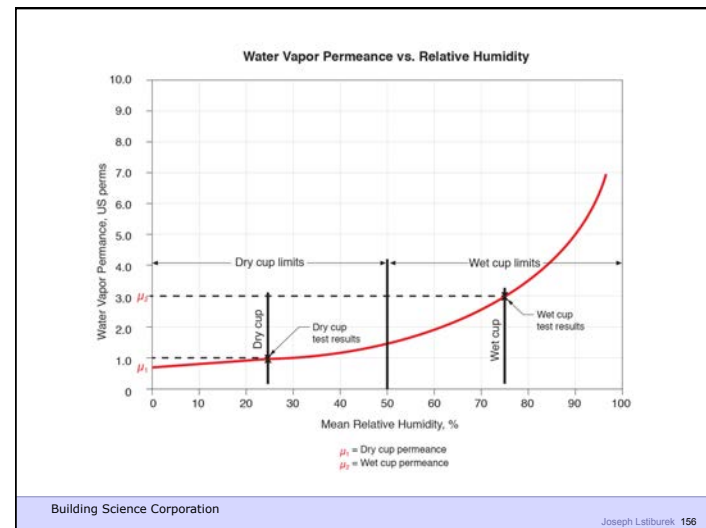
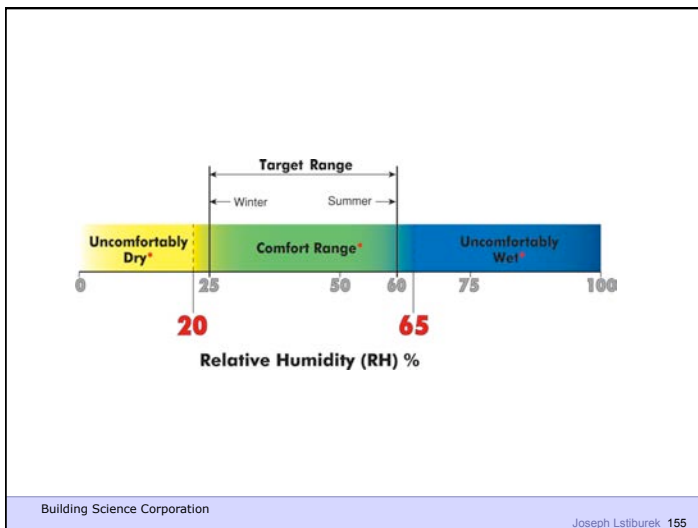

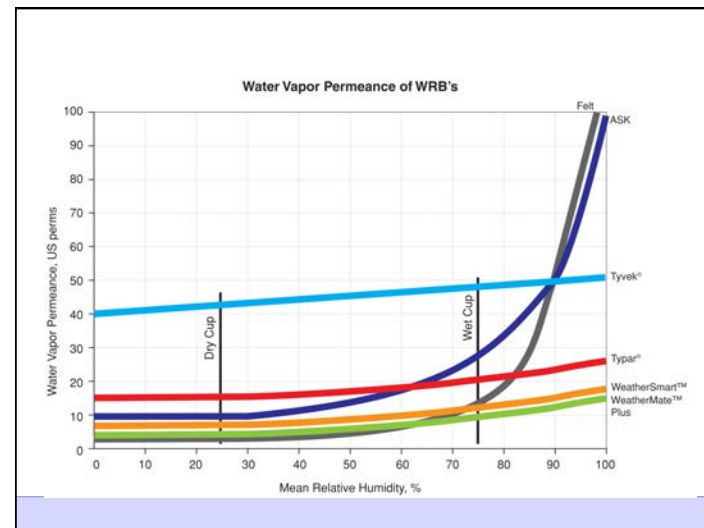
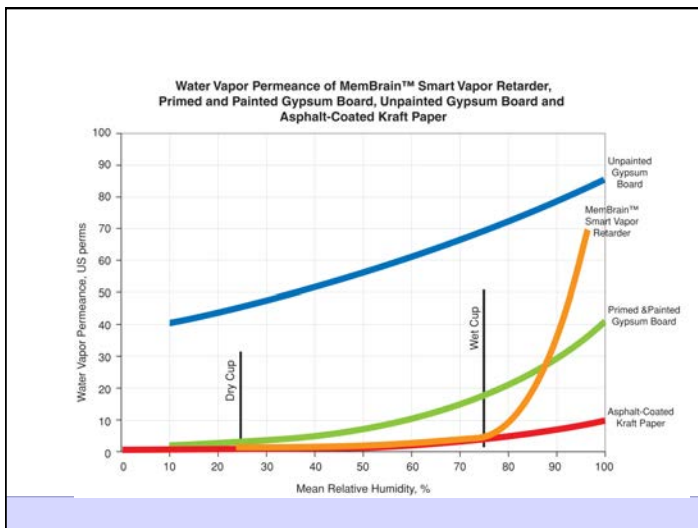
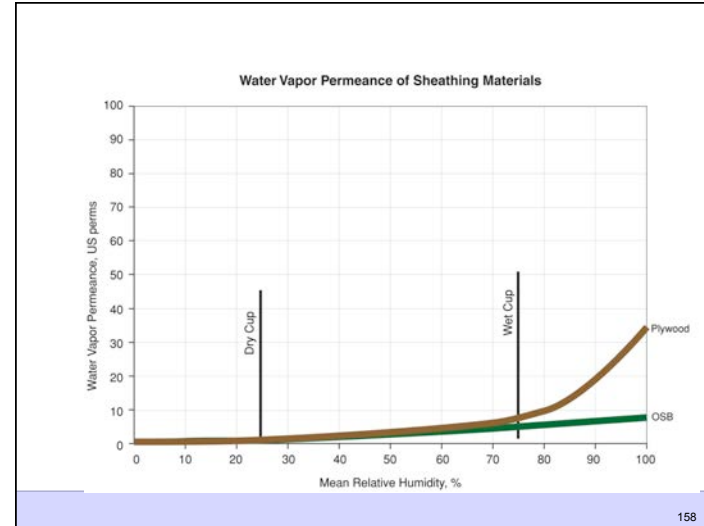

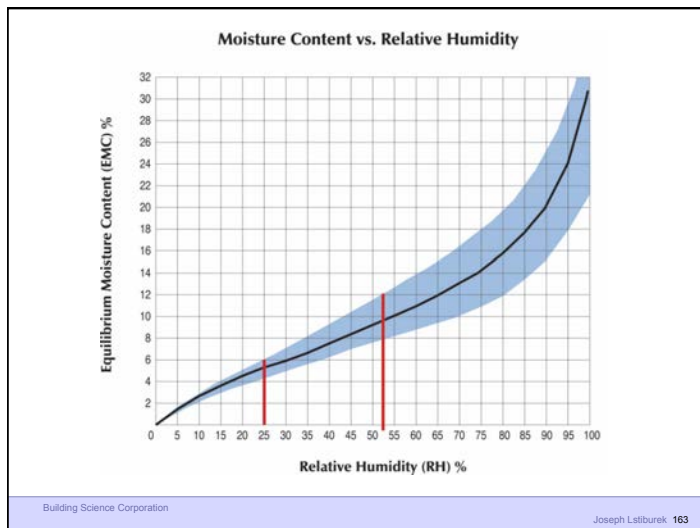
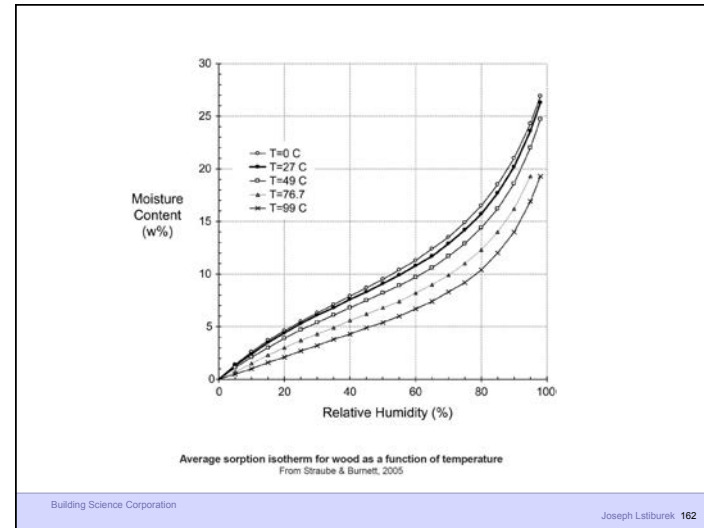
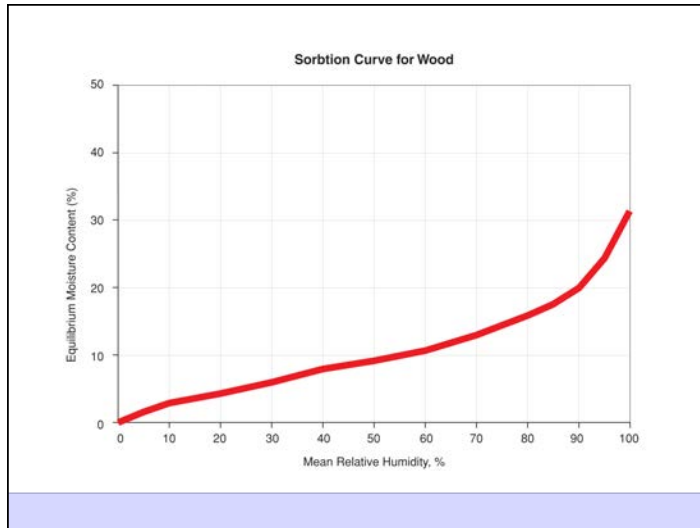

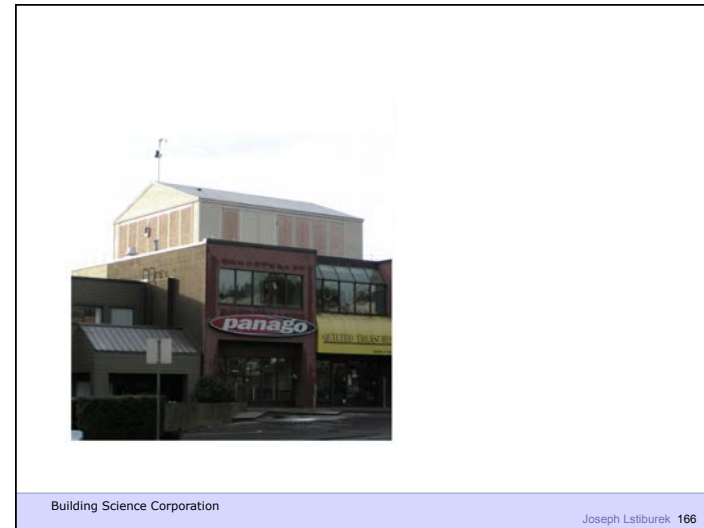
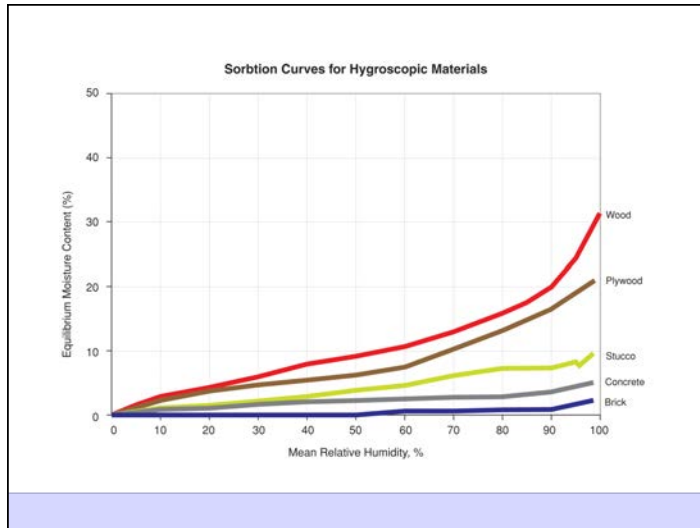

Building Science Corporation

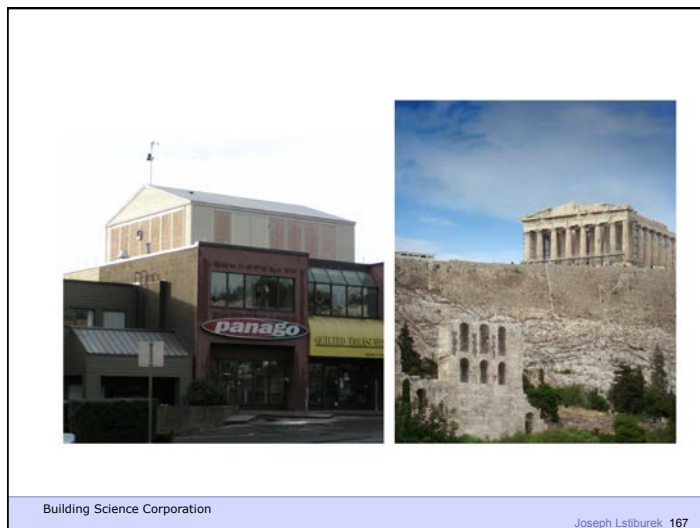

Building Science Corporation



Building Science Corporation

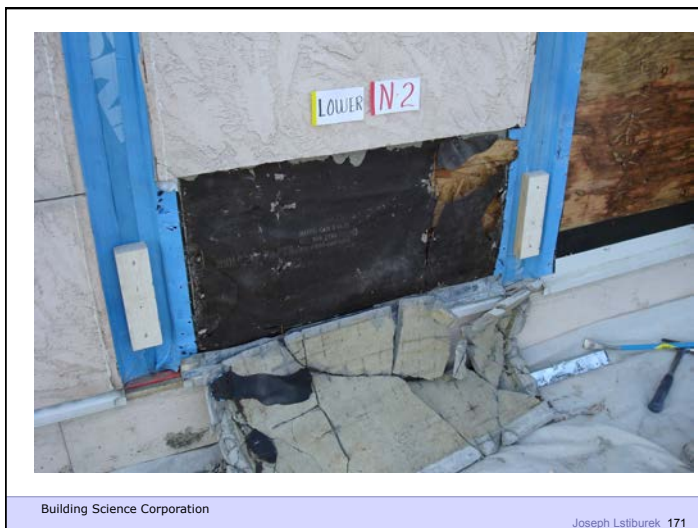

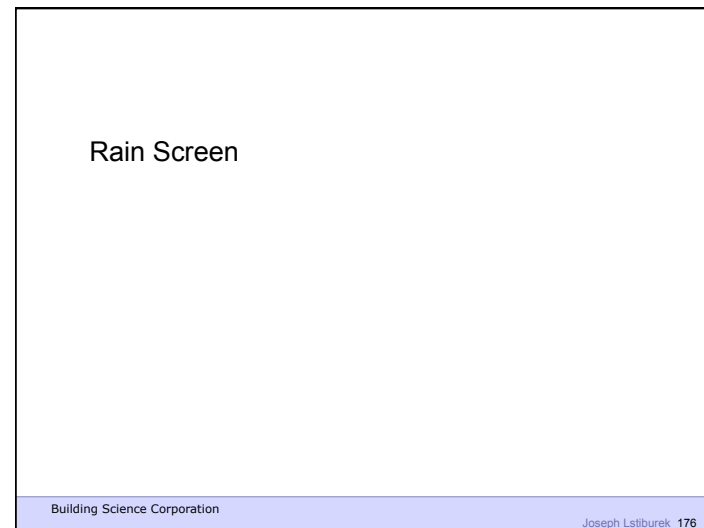
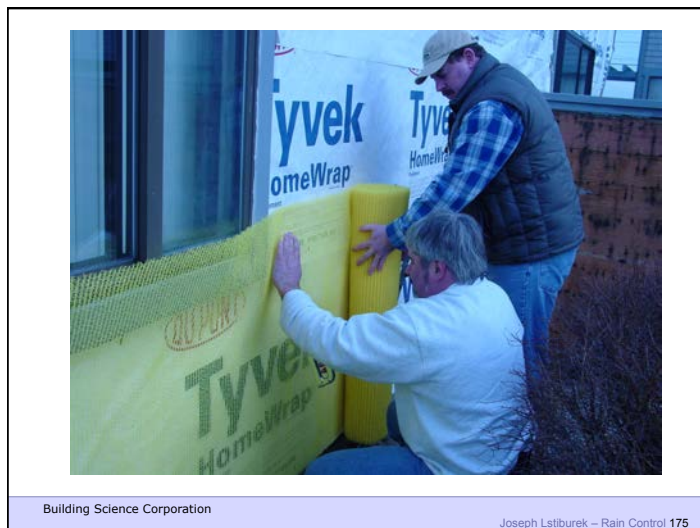
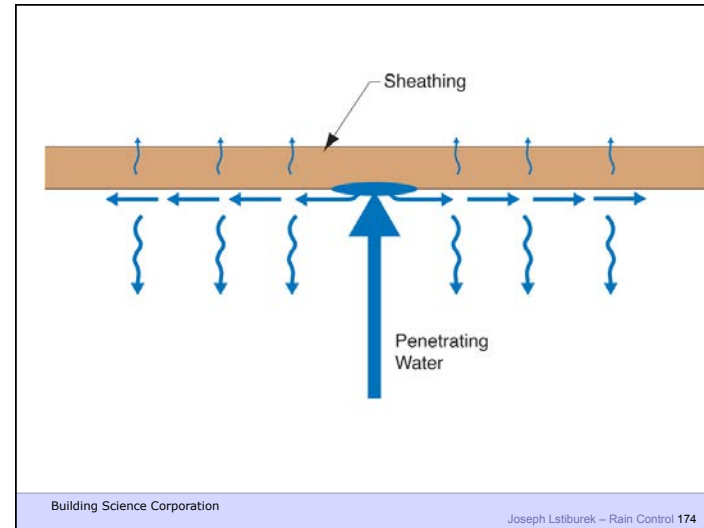
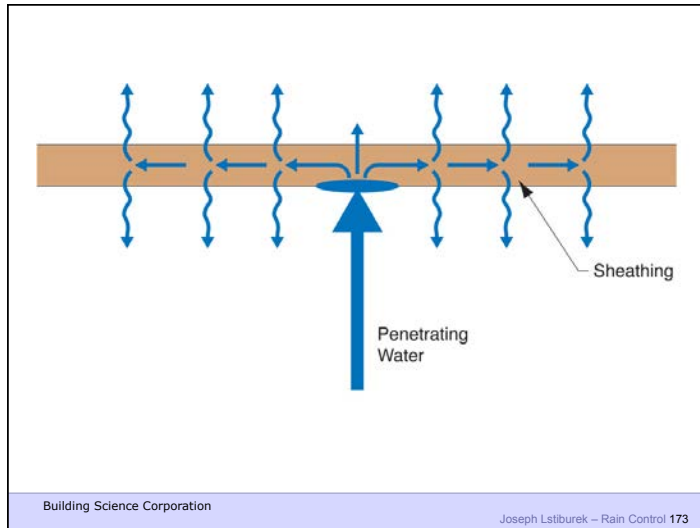

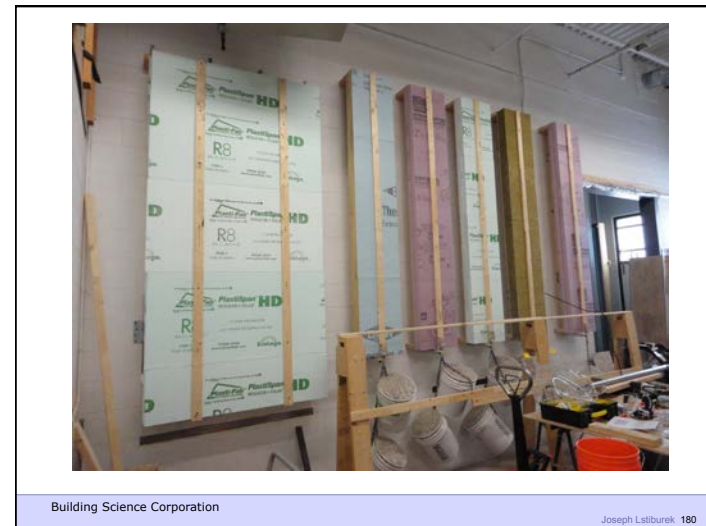
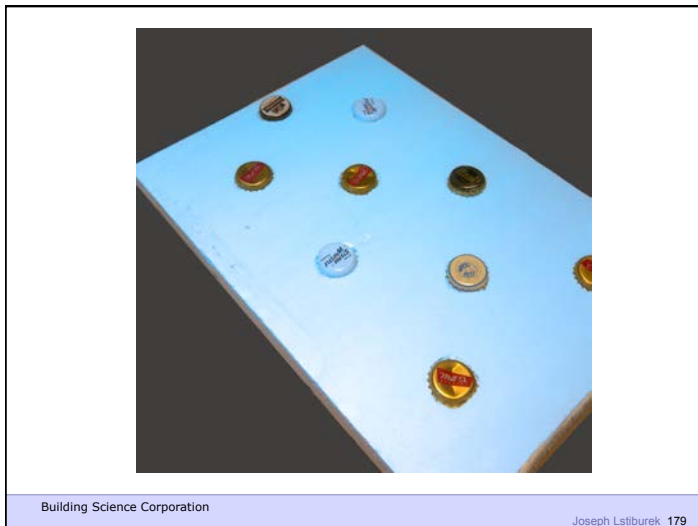
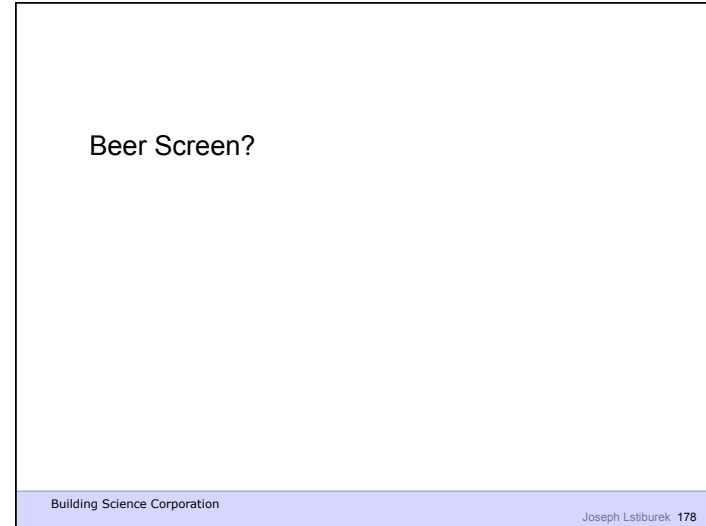
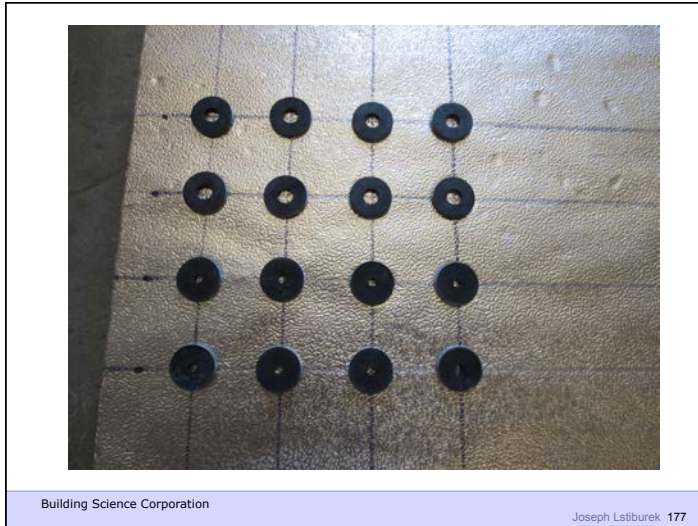

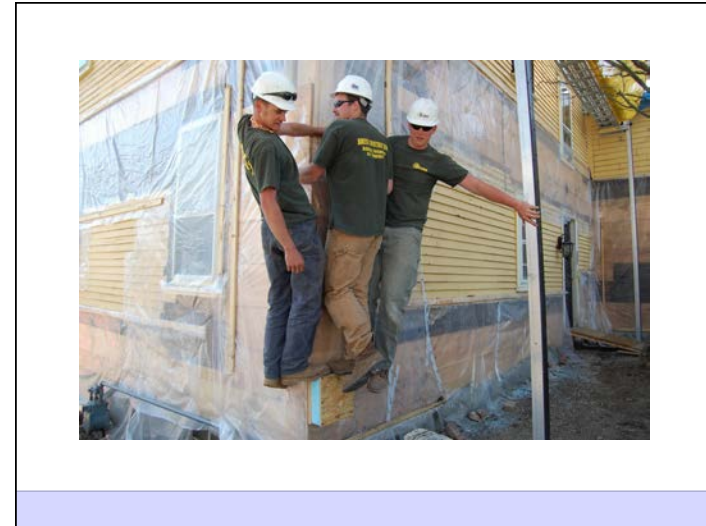

Rockwool

1x3 furring @ 24" o.c.
 #10 screws @ 16" o.c. vertically
 Result: 20 psf cladding weight
 with < 2/100" deflection

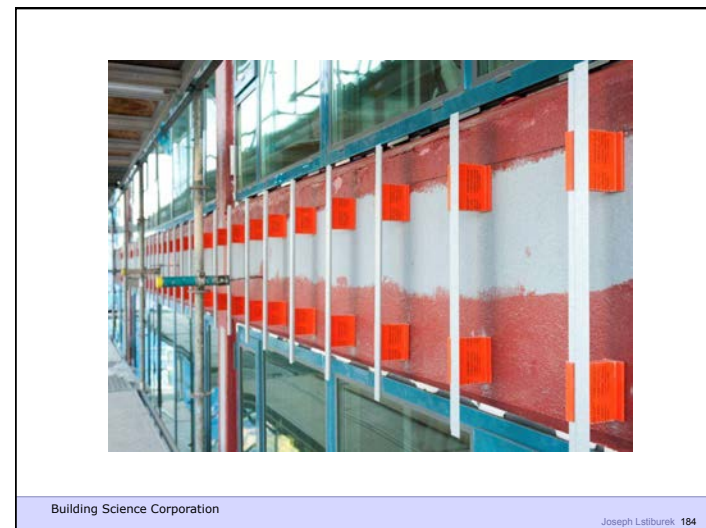

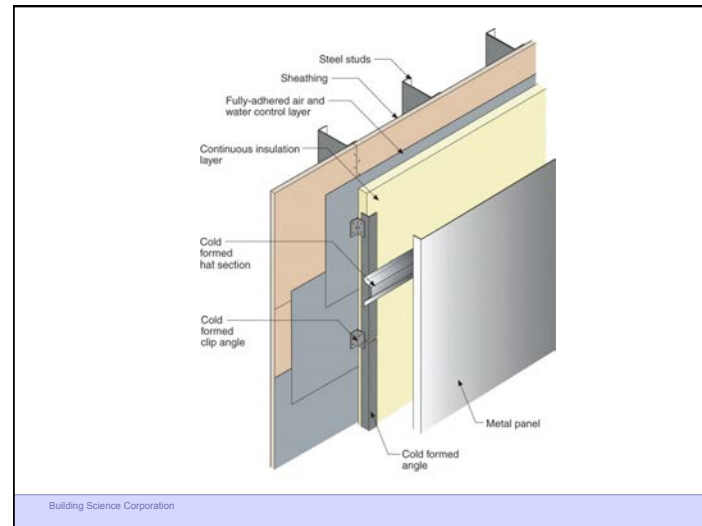
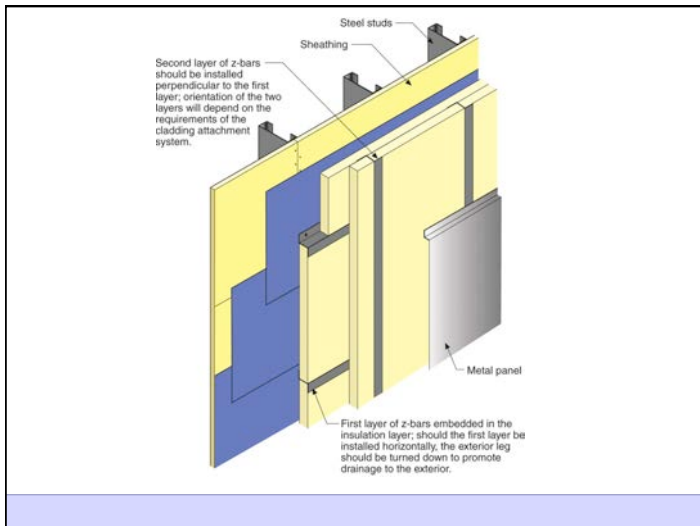
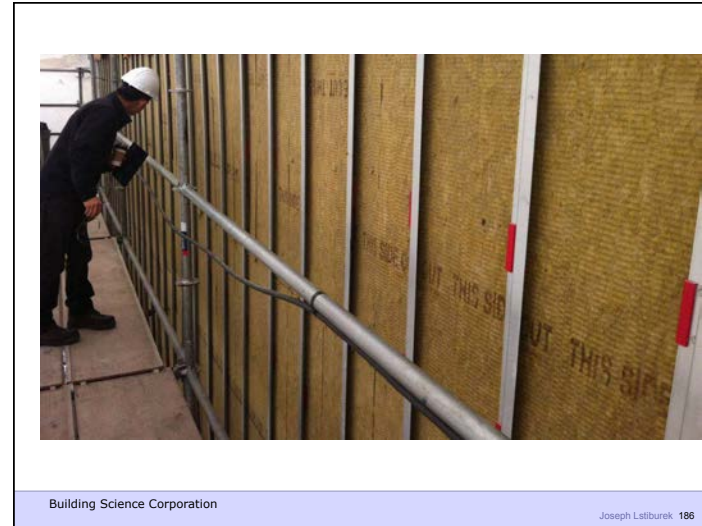
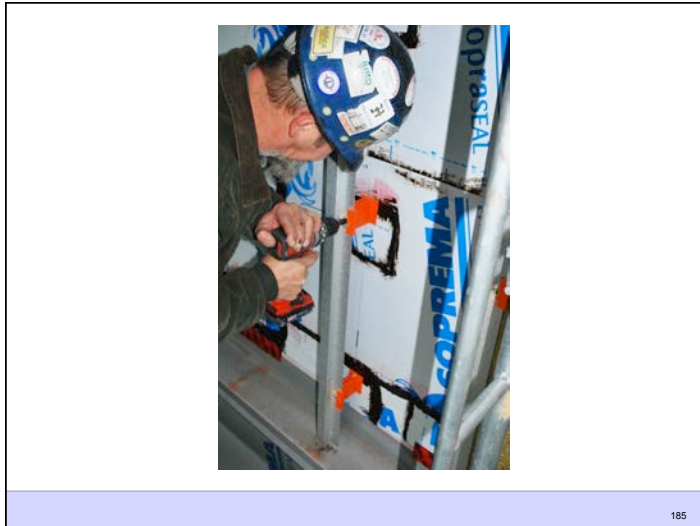

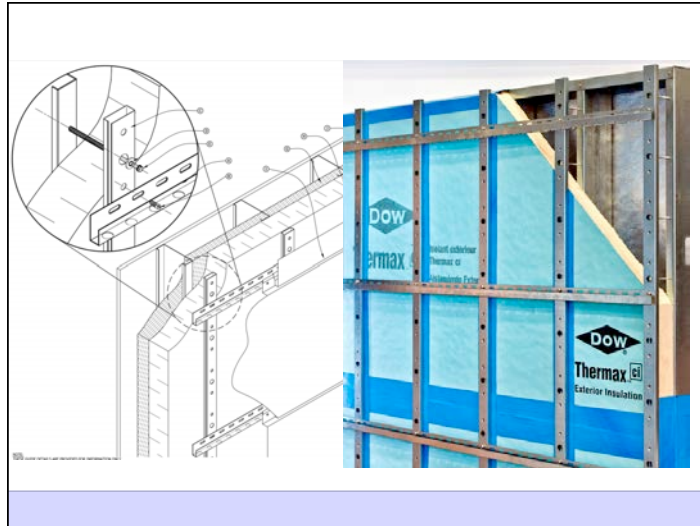

Building Science Corporation

Joseph Lstiburek – Rain Control 190



Building Science Corporation

Joseph Lstiburek – Rain Control 191



Building Science Corporation

Joseph Lstiburek – Rain Control 192

