

Vapor Barriers and Wall Design

Research Report - 0410

November-2004

Joseph Lstiburek

Abstract:

Good design and practice involve controlling the wetting of building assemblies from both the exterior and interior and different climates require different approaches.

Wall Design

Ideally, building assemblies would always be built with dry materials under dry conditions, and would never get wet from imperfect design, poor workmanship or occupants. Unfortunately, these conditions do not exist.

It has been accepted by the building industry that many building assemblies become wet during service, and in many cases start out wet. Furthermore, the industry has recognized that in many circumstances it may be impractical to design and build building assemblies which never get wet. This has given rise to the concept of acceptable performance. Acceptable performance implies the design and construction of building assemblies which may periodically get wet, or start out wet yet are still durable and provide a long, useful service life. Repeated wetting followed by repeated drying can provide acceptable performance if during the wet period, materials do not stay wet long enough under adverse conditions to deteriorate.

Good design and practice involve controlling the wetting of building assemblies from both the exterior and interior. They also involve the drying of building assemblies should they become wet during service or as a result of building with wet materials or under wet conditions.

Moisture Balance

Moisture accumulates when the rate of moisture entry into an assembly exceeds the rate of moisture removal. When moisture accumulation exceeds the ability of the assembly materials to store the moisture without degrading performance or long term service life, moisture problems result.

Building assemblies can get wet from the building interior or exterior, or they can start out wet as a result of the construction process due to wet building materials or construction under wet conditions. Good design and practice address these wetting mechanisms.

Various strategies can be implemented to minimize the risk of moisture damage. The strategies fall into the following three groups:

- control of moisture entry
- control of moisture accumulation
- removal of moisture

Strategies in the three groupings can be utilized in combination and have been proven to be most effective in that manner. Strategies effective in the control of moisture entry, however, are often not effective if building assemblies start out wet, and in fact can be detrimental. If a technique is effective at preventing moisture from entering an assembly, it is also likely to be effective at preventing moisture from leaving an assembly. Conversely, a technique effective at removing moisture may also allow moisture to enter. Balance between entry and removal is the key in many assemblies.

Historically successful approaches to moisture control have typically been based on the following strategy: prevent building assemblies and surfaces from getting wet from the exterior, prevent building assemblies and surfaces from getting wet from the interior, and should building assemblies or surfaces get wet, or start out wet, allow them to dry the exterior, the interior or both.

Approach

Water can come in several phases: liquid, solid, vapor and adsorbed. The liquid phase as rain and ground water has driven everyone crazy for hundreds of years but can be readily understood — drain everything and remember the humble flashing. The solid phase also drives everyone crazy when we have to shovel it or melt it, but at least most professionals understand the related building problems (ice damming, frost heave, freeze-thaw damage). But the vapor phase is in a class of craziness all by itself. We will conveniently ignore the adsorbed phase and leave it for someone else to deal with. Note that adsorbed water is different than absorbed water.

The fundamental principle of control of water in the liquid form is to drain it out if it gets in — and let us make it perfectly clear it will get in if you build where it rains or if you put your building in the ground where there is water in the ground. This is easy to understand, logical, with a long historical basis.

The fundamental principle of control of water in the solid form is to not let it get solid; and, if it does, give it space; or, if it is solid not let it get liquid; and, if it does drain it away before it can get solid again. This is a little more difficult to understand, but logical and based on solid research. Examples of this principle include the use of air en-

trained concrete to control freeze-thaw damage and the use of attic venting to provide cold roof decks to control ice damming.

The fundamental principle of control of water in the vapor form is to keep it out and to let it out if it gets in. Simple, right? No chance. It gets complicated because sometimes the best strategies to keep water vapor out also trap water vapor in. This can be a real problem if the assemblies start out wet because of the use of wet materials or get wet via a liquid form like rain.

It gets even more complicated because of climate. In general water vapor moves from the warm side of building assemblies to the cold side of building assemblies. This is simple to understand, except we have trouble deciding what side of a wall is the cold or warm side. Logically, this means we need different strategies for different climates. We also have to take into account differences between summer and winter.

Finally, complications arise when materials can store water. This can be both good and bad. A cladding system such as a brick veneer can act as a reservoir after a rainstorm and significantly complicate wall design. Alternatively, wood framing or masonry can act as a hygric buffer absorbing water lessening moisture shocks.

What is required is to define vapor control measures on a more regional climatic basis and to define the vapor control measures more precisely.

Building assemblies can be designed to dry to either the outside or the inside or to both sides. The rules to accomplish this depend on the climate zone. In general, assemblies should be designed to dry to the outside in cold climates, to the inside in hot-humid climates and to both sides in mixed-dry climates and hot-dry climates. In mixed-humid climates it is preferable to design assemblies to dry to the inside and to control exterior sheathing temperatures during heating periods using insulating sheathing.

Wall Assembly Design Recommendations

The following wall assembly design recommendations are climatically based and are sensitive to cladding type (vinyl siding, brick or stone veneer, stucco).

The recommendations apply to residential occupancies. The recommendations do not apply to business, assembly, educational and mercantile occupancies and to special use enclosures such as spas, pool buildings, museums, hospitals, data processing centers or other engineered enclosures such as factory, storage or utility enclosures.

The recommendations are based on the following principles:

- Avoidance of using vapor barriers where vapor retarders will provide satisfactory performance. Avoidance of using vapor retarders where vapor permeable materials will provide satisfactory performance. Thereby encouraging drying mechanisms over wetting prevention mechanisms.
- Avoidance of the installation of vapor barriers on both sides of assemblies — i.e. "double vapor barriers" in order to facilitate assembly drying in at least one direction.
- Avoidance of the installation of vapor barriers such as polyethylene vapor barriers, foil-faced batt insulation and reflective radiant barrier foil insulation on the interior of air-conditioned assemblies — a practice that has been linked with moldy buildings.
- Avoidance of the installation of vinyl wall coverings on the inside of air conditioned assemblies — a practice that has been linked with moldy buildings.

Each of the wall assembly design recommendations were evaluated using dynamic hygrothermal modeling. The moisture content of building materials that comprise the building assemblies all remained below the limiting-equilibrium moisture contents as specified in ASHRAE 160 P under this evaluation approach. Interior air conditions and exterior air conditions as specified by ASHRAE 160 P were used. WUFI was used as the modeling program.

More significantly, each of the assembly design recommendations have been found by the author to provide satisfactory performance under the limitations noted. Satisfactory performance is defined as no moisture problems reported or observed over at least a 15 year period.

Climate Basis for Design

Zones 5, 6 and 7 as noted on Figure 1 correspond to the zones defined by the International Residential Code (IRC) and the International Conservation Code (IECC). They are more precisely defined as:

- Zone 5: Greater than 5,400 heating degree days (at 65°F basis) and less than or equal to 7,200 heating degree days (at 65°F basis)¹
- Zone 6: Greater than 7,200 heating degree days (at 65°F basis) and less than or equal to 9,000 heating degree days (at 65°F basis)²
- Zone 7: Greater than 9,000 heating degree days (at 65°F basis) and less than or equal to 12,600 heating degree days (at 65°F basis)³

The division of the hygro-thermal zones in this manner establishes the exterior environmental load on the wall assemblies that needs to be addressed by the design approach.

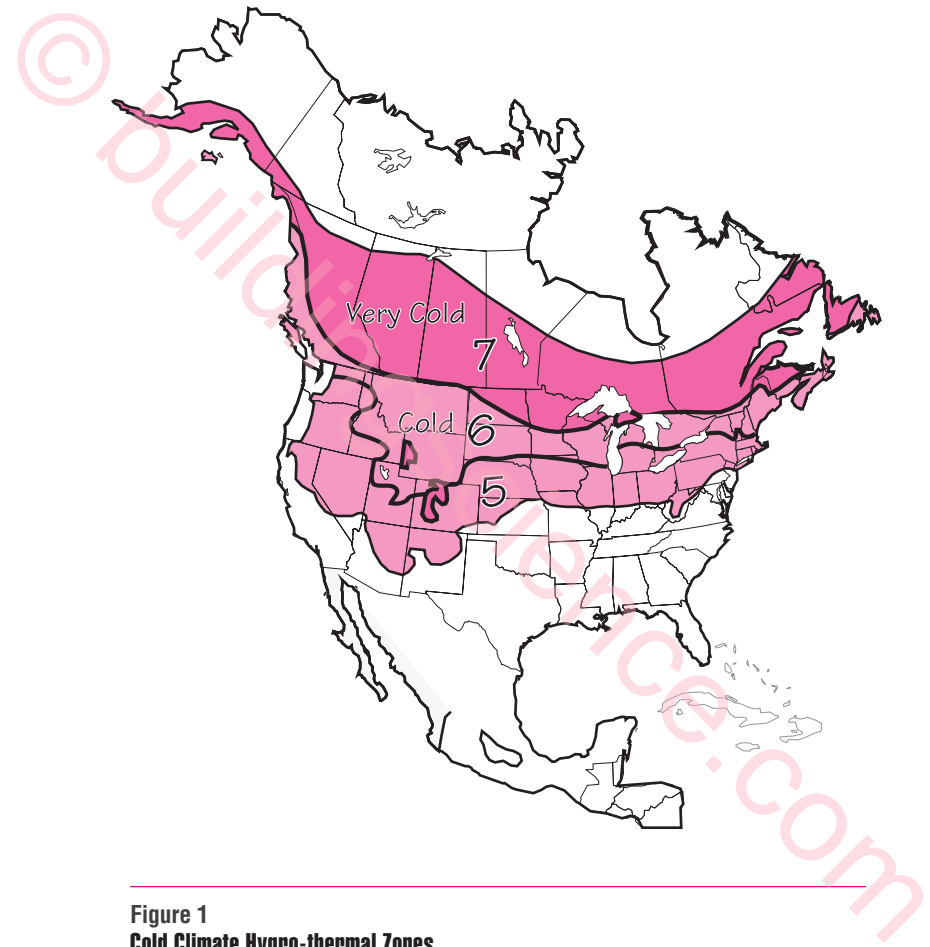

Figure 1
Cold Climate Hygro-thermal Zones

- ¹ Celsius: Greater than 3,000 heating degree days (18°C basis) and less than or equal to 4,000 heating degree days (18°C basis)
- ² Celsius: Greater than 4,000 heating degree days (18°C basis) and less than or equal to 5,000 heating degree days (18°C basis)
- ³ Celsius: Greater than 5,000 heating degree days (18°C basis) and less than or equal to 7,000 heating degree days (18°C basis)

Assembly Characteristics

The design approach is dependent on the vapor permeance and thermal characteristics of the wall sheathing/cladding assembly.

The rationale for this is based on two important factors. The first is vapor permeance. How easy water vapor gets out of the assembly to the outside determines how much resistance to water vapor entry from the interior can be allowed.

The second is the temperature of the condensing or moisture accumulation surface. How cold the cavity side of the sheathing is determines how much moisture accumulates on the sheathing. The colder this surface, the more moisture that accumulates; the warmer this surface the less moisture that accumulates. Therefore, this temperature (which is based on the thermal resistance of the sheathing) also determines how much resistance to water vapor entry from the interior can be allowed.

Combining the two factors, vapor permeance of the sheathing/cladding assembly and the temperature of the sheathing (thermal resistance of the sheathing) determines the amount of resistance to water vapor entry from the interior that is necessary (i.e. the vapor permeance of the interior of the assembly — the class of vapor retarder required).

Vapor Permeance Characteristics

The vapor permeance characteristic of the sheathing/cladding assembly is defined by the effective wet cup permeance of both the cladding and sheathing combined. Three categories are established:

- Vapor impermeable Less than or equal to 0.1 perm
- Vapor semi-impermeable Less than or equal to 1 perm and greater than 0.1 perm
- Vapor semi-permeable Greater than 1 perm

For example, a foil-faced isocyanurate rigid insulation is classed as vapor impermeable regardless of the cladding type installed external to the foil-faced isocyanurate.

OSB sheathing and plywood sheathing covered with a building paper or housewrap and vinyl siding are classed as vapor semi-permeable.

However, when the vinyl siding is replaced with a traditional three-coat hard-coat stucco the combined wet cup permeance of both stucco, building paper and OSB (or plywood) sheathing is below 1.0 perm and therefore, this assembly is classed as vapor semi-permeable. The application of the stucco in this manner clearly affects the drying characteristics of the wall; the stucco is relatively "airtight" whereas the vinyl siding is "air leaky."

If the traditional three-coat hard-coat stucco is subsequently "back

vented" (i.e. installed over an airspace) the assembly is now classed as vapor semi-permeable.

Wet cup permeances are used because it is the performance of the assembly under "wet conditions" that we are concerned with.

The following table lists the wet cup permeance characteristics of common assemblies and materials:

Vinyl siding	Approximately 40 perms due to the air leakage of the siding joints	Vapor permeable
Wood siding	Approximately 10 perms due to the air leakage of the siding joints	Vapor permeable
Brick veneer	Approximately 40 perms due to air leakage from the "back venting" of the brick veneer	Vapor permeable
Building paper/asphalt impregnated felt	Approximately 30 perms	Vapor permeable
Housewraps	Range between 5 perms and 50 perms	Vapor semi-permeable to vapor permeable
OSB sheathing	Approximately 2 perms	Vapor semi-permeable
Plywood sheathing	Approximately 10 perms	Vapor semi-permeable
Traditional three-coat hard-coat stucco over building paper and OSB or plywood sheathing	Less than 1 perm and greater than 0.1 perm	Vapor semi-impermeable
External Insulation Finish System (EIFS) installed over 1-inch EPS and OSB or plywood or non-paper faced gypsum sheathing	Greater than 1 perm	Vapor semi-permeable
Extruded polystyrene insulation (XPS); less than 1-inch in thickness and unfaced	Greater than 1 perm	Vapor semi-permeable
Extruded polystyrene insulation (XPS); greater than or equal to 1-inch in thickness and unfaced	1 perm or less and greater than 0.1 perm	Vapor semi-impermeable

continued

Extruded polystyrene insulation (XPS); any thickness and faced with polypropylene facings	Less than or equal to 0.1 perm	Vapor impermeable
Extruded polystyrene insulation (XPS); ³ / ₄ -inch or less in thickness and faced with perforated polypropylene facings	1 perm or less and greater than 0.1 perm	Vapor semi-impermeable
Expanded polystyrene insulation (EPS); less than 3 inches in thickness and unfaced	Greater than 1 perm	Vapor semi-permeable
Expanded polystyrene insulation (EPS); less than 2 inches in thickness and faced with perforated polypropylene facings	1 perm or less and greater than 0.1 perm	Vapor semi-impermeable
Expanded polystyrene insulation (EPS); any thickness and faced with polypropylene or foil facings	Less than or equal to 0.1 perm	Vapor impermeable
Coated/faced thin profile structural sheathing	1 perm or less and greater than 0.1 perm	Vapor semi-impermeable
Foil-faced isocyanurate; any thickness	Less than or equal to 0.1 perm	Vapor impermeable

Thermal Characteristics

The thermal characteristics of the cavity side of the sheathing (i.e. the temperature of the cavity side of the sheathing — T_s) are determined by the temperature difference across the wall assembly (ΔT) and the ratio of the thermal resistance of the sheathing (R_s) compared to the total thermal resistance of the wall assembly (R_T). The total thermal resistance of the wall assembly (R_T) is the sum of the thermal resistance of the cavity insulation (R_C) and the thermal resistance of the sheathing (R_s). The following equation is used to determine T_s .

where:

$$T_s = T_1 - \Delta T (R_C / R_T)$$

$$R_T = R_s + R_C \text{ and } \Delta T = T_1 - T_0$$

T_s = temperature of the interior surface of the exterior sheathing

T_1 = temperature of the interior air

ΔT = temperature difference across wall

R_C = thermal resistance of the cavity

R_s = thermal resistance of the sheathing

R_T = thermal resistance of the wall

T_0 = temperature of the outside air

The following example illustrates the method of calculation to determine T_s :

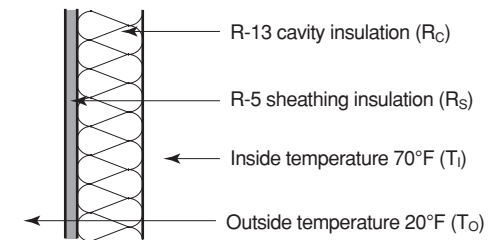

The temperature difference across the wall assembly $\Delta T = T_1 - T_0$ or $70^\circ\text{F} - 20^\circ\text{F}$ or 50°F .

The total thermal resistance of the wall assembly $R_T = R_s + R_C$ or R-13 plus R-5 or R-18.

Using $T_s = T_1 - \Delta T (R_C / R_T)$ yields

$$= 70 - 50 (13 / 18)$$

$$= 70 - 50 (0.72)$$

$$= 70 - 36$$

$$= 34^\circ\text{F}$$

Using this approach the thermal resistance of the interior finishes and exterior cladding and associated air films are ignored along with the thermal bridging effects of the wall framing.

Application

The permeance of the sheathing/cladding assembly and the temperature of the cavity side of the exterior sheathing (T_s) determine the recommended class of the interior vapor retarder on a climate specific basis.

The location (climate zone) determines the exterior design temperature (T_o). For calculation purposes (when using this procedure only) the average temperature of the coldest three months is used (December, January, and February)*.

The location (climate zone) and the permeance of the sheathing/cladding assembly also determine the interior dewpoint condition to be used in the calculation procedure.

As the exterior design temperature (T_o) drops the interior design dewpoint also drops. This is both an artifact of the methodology and based on the fact that lower interior R.H. conditions are typical the more severe (colder) the climate.

However, as the permeance of the sheathing/cladding assembly goes up, the interior design dewpoint also goes up. The reason for this is an artifact of the methodology — a "trick" to provide a more conservative result (i.e. a safety factor) wherever a low vapor resistance control (i.e. a vapor semi-permeable Class III vapor retarder) is recommended (rather than a vapor semi-permeable Class II vapor retarder).

Flow charts (Figure 2, Figure 3, Figure 4 and Figure 5) present the overall wall assembly design approach. The first step is to determine the sheathing/cladding assembly permeance and that ultimately establishes the class of interior vapor retarder required. Where insulating sheathings are used, the thermal resistance of the insulating sheathing is used to provide options on the class of interior vapor retarder required.

As the thickness of the insulating sheathing (and its thermal resistance) increases so does the sheathing temperature (T_s) and therefore, the class of interior vapor retarder required becomes less restrictive.

This is determined by "the dewpoint test."

The Dewpoint Test

An interior dewpoint design condition is established by the flow chart. For example, if an interior relative humidity of 30% is maintained at 70°F the resulting interior dewpoint is 37°F.

The "test" requires that the temperature of the cavity side of the sheathing (T_s) under the calculation procedure be at least 37°F or higher. The calculation procedure was described earlier.

Examples of Wall Assemblies that Follow the Approach

The following wall assemblies meet the design approach presented in the flow charts. Recall that this approach is a "simplification" or a "road map" that arises out of the detailed dynamic hygro-thermal modeling — and more importantly — extensive field testing and field experience.

Each branch of the respective flow charts yields a wall assembly design — some branches yield two designs — to reflect the effect of 2x4 vs. 2x6 cavity insulation on the temperature of the cavity side of the sheathing (T_s).

What this Means from a Practical Perspective

Polyethylene is a Class I vapor retarder. A kraft-faced fiberglass batt is a Class II vapor retarder as is a "smart vapor retarder (SVR)**." Latex painted gypsum board (one coat of latex paint) is a Class III vapor retarder.

Plywood sheathing and oriented strand board (OSB) have perm values of greater than 1 perm when using the wet cup test. Similarly for exterior gypsum sheathing or fiberboard sheathing.

Extruded polystyrene of 1-inch thick or thicker has a perm value of 1.0 perm or less. Film-faced extruded polystyrenes of 1/2-inch thickness that have perforated facings have perm values of greater than 1 perm. Non-perforated foil- and polypropylene-faced rigid insulations have perm values of less than 0.1 perms.

Three-coat hard-coat stucco installed over two layers of Type D asphalt saturated kraft paper and OSB has a combined perm value of less than 1.0 under a wet cup test. Therefore, the sheathing/cladding assembly is less than or equal to 1.0 as tested by Test Method B of ASTM E-96.

No assembly constructed in Climate Zone 4, 5, 6 or 7 requires a Class I vapor retarder (i.e. a polyethylene vapor barrier). The approach does not prevent you from using one, it just does not make you use one.

The approach, via the use of insulating sheathing, allows the construction of assemblies that are vapor open to the interior in all climate zones. Interior vapor resistance, beyond that of latex painted gypsum board, is not required if sufficient thermal resistance is provided by insulating sheathing.

* Source: Climatological Normals, Normal Daily Mean Temperature, 30 year average (1971-2000), National Oceanic and Atmospheric Administration (NOAA)

** SVR's are engineered materials that are designed to change their permeance at specific relative humidities, such as at 50% RH.

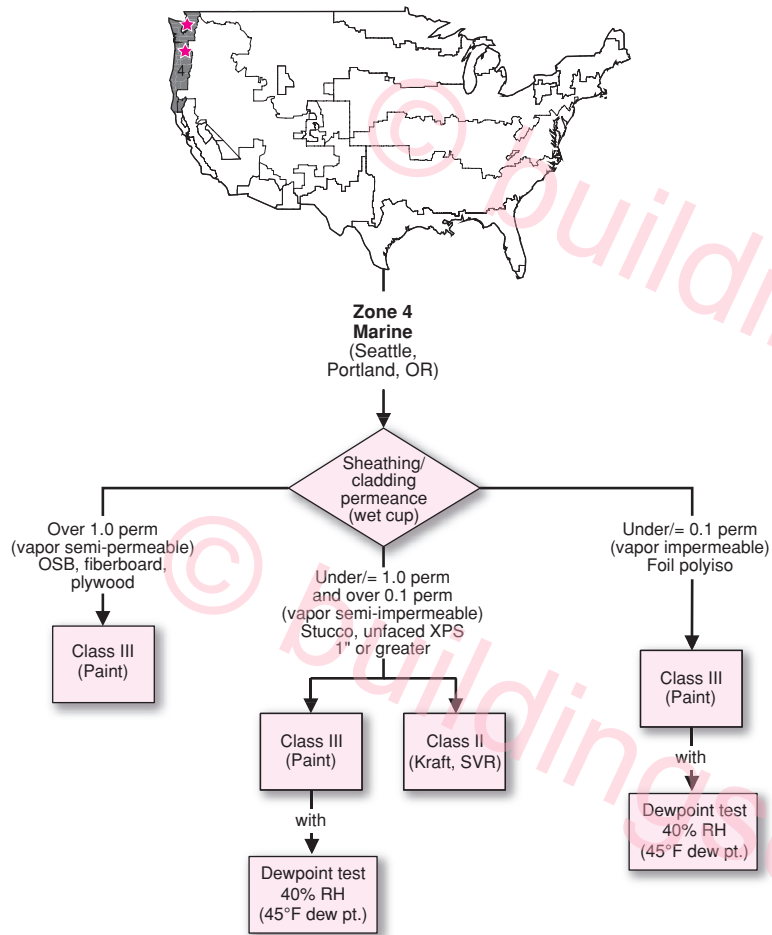

Figure 2
Climate Zone 4 Marine Flow Chart
 • Includes Seattle and Portland, Oregon

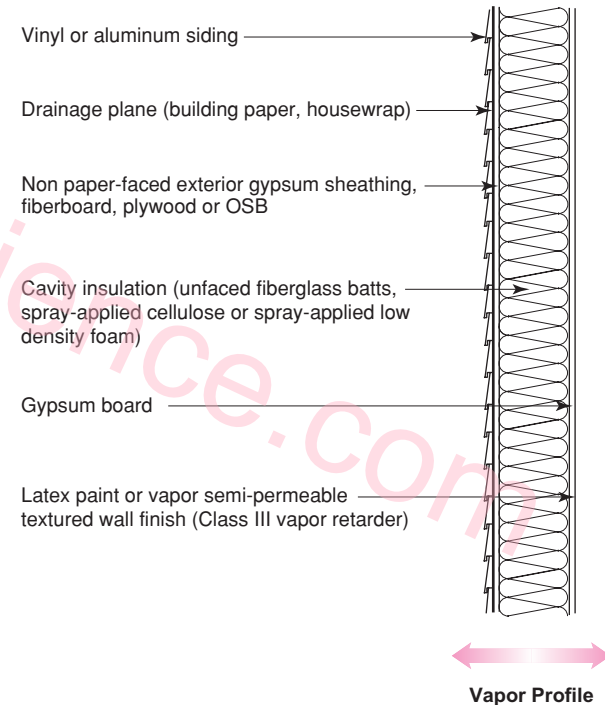
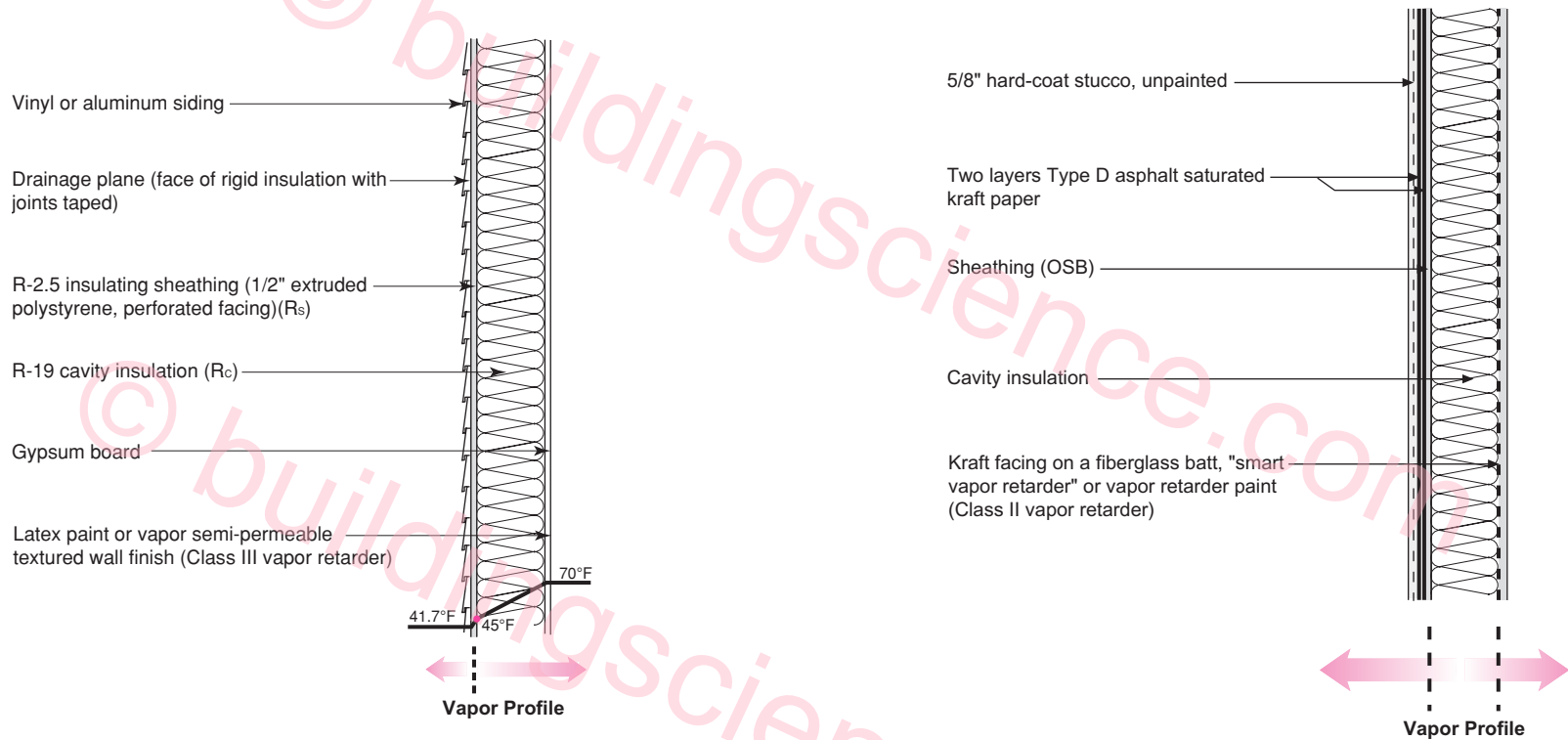

Figure 2a
Sheathing/Cladding Assembly Permeance (Wet Cup) Greater than 1.0 Perm — Seattle

- This is a "flow through" assembly that is very "vapor open" to the exterior and therefore in the **mild** climate of Chicago **does not** require a specific "vapor resistance" on the interior

Dewpoint Test at 40% RH (Seattle) — 2X6 Wall

- Dewpoint temperature of 70°F, 40% RH air is 45°F. Therefore, the temperature of the cavity side of the sheathing (T_s) must be greater than 45°F.
- Temperature of the outside air is the average temperature of December (41°F), January (41°F) and February (43°F) or 41.7°F.



T_i	T_o	ΔT	R_c	R_s	R_t	T_s
70	41.7	28.3	19	2.5	21.5	45

Figure 2b
Sheathing/Cladding Assembly Permeance (Wet Cup)

Less than or Equal to 1.0 Perm and Greater than 0.1 Perm — Seattle

- This assembly has some exterior "vapor resistance," but since this resistance is provided by an insulating sheathing that also "**sufficiently warms**" the "condensing surface" (the cavity side of the sheathing) this assembly **does not** require a specific "vapor resistance" on the interior

Figure 2c
Sheathing/Cladding Assembly Permeance (Wet Cup)

Less than or Equal to 1.0 Perm and Greater than 0.1 Perm — Seattle

- This assembly has **some** exterior "vapor resistance" and this resistance does not "warm" the "condensing surface" (the cavity side of the sheathing), therefore this assembly **does** require a specific "vapor resistance" on the interior

Dewpoint Test at 40% RH (Seattle) — 2X6 Wall

- Dewpoint temperature of 70°F, 40% RH air is 45°F. Therefore, the temperature of the cavity side of the sheathing (T_s) must be greater than 45°F.
- Temperature of the outside air is the average temperature of December (41°F), January (41°F) and February (43°F) or 41.7°F.

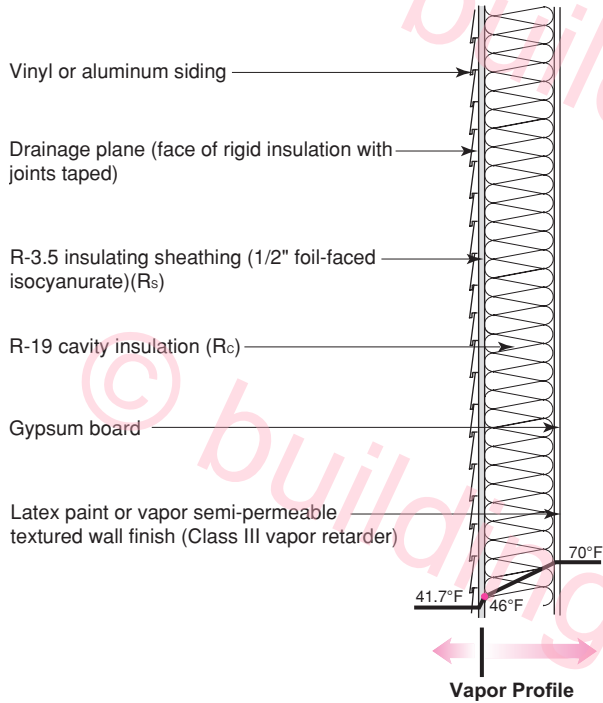

T_i	T_o	ΔT	R_c	R_s	R_T	T_s
70	41.7	28.3	19	3.5	22.5	46

Figure 2d
Sheathing/Cladding Assembly Permeance (Wet Cup)
Less than or Equal to 0.1 Perm — Seattle

- This assembly has **significant** exterior "vapor resistance," but since this resistance is provided by an insulating sheathing that also **sufficiently warms** the "condensing surface" (the cavity side of the sheathing) this assembly **does not** require a specific "vapor resistance" on the interior

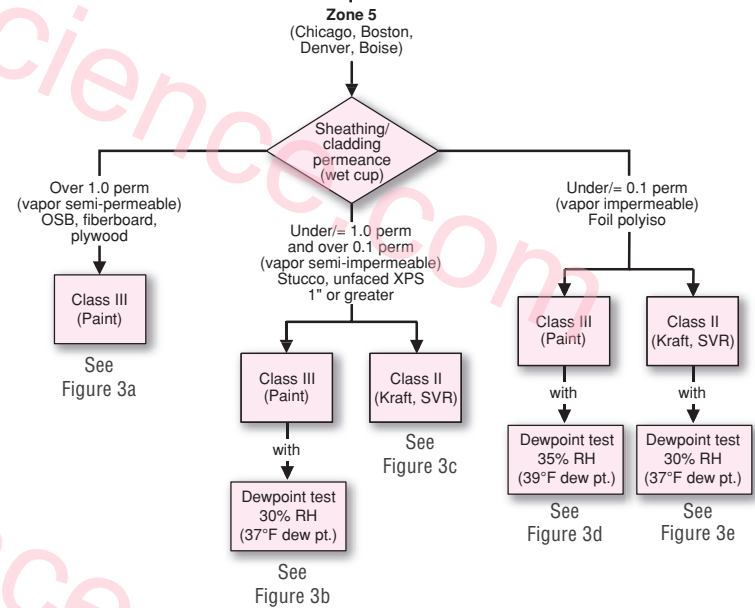
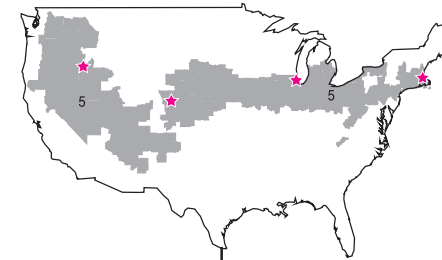

Figure 3
Climate Zone 5 Flow Chart

- Includes Chicago, Boston, Denver and Boise

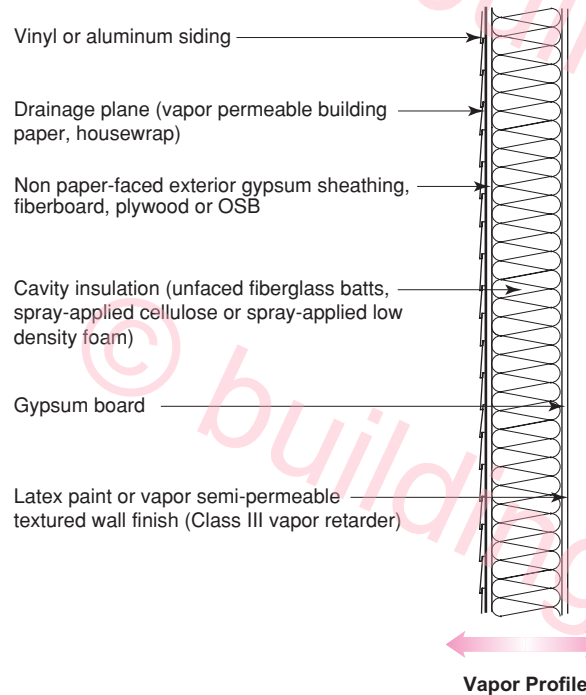
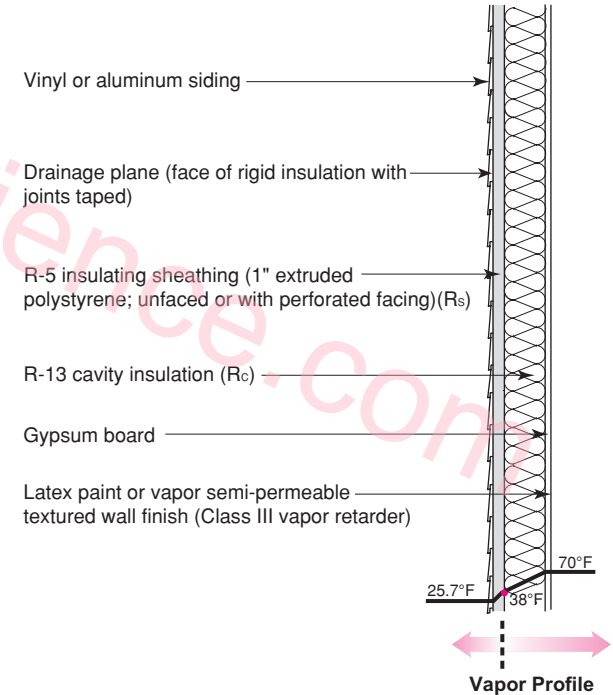

Figure 3a
Sheathing/Cladding Assembly Permeance (Wet Cup) Greater than 1.0 Perm — Chicago

- This is a "flow through" assembly that is very "vapor open" to the exterior and therefore in the **moderately cold** climate of Chicago **does not** require a specific "vapor resistance" on the interior

Dewpoint Test at 30% RH (Chicago) — 2X4 Wall

- Dewpoint temperature of 70°F, 30% RH air is 37°F. Therefore, the temperature of the cavity side of the sheathing (T_s) must be greater than 37°F.
- Temperature of the outside air is the average temperature of December (28°F), January (22°F) and February (27°F) or 25.7°F.



T_i	T_o	ΔT	R_c	R_s	R_T	T_s
70	25.7	44.3	13	5	18	38

Figure 3b.1
Sheathing/Cladding Assembly Permeance (Wet Cup)
Less than or Equal to 1.0 Perm and Greater than 0.1 Perm — Chicago

- This assembly has some exterior "vapor resistance," but since this resistance is provided by an insulating sheathing that also **sufficiently warms** the "condensing surface" (the cavity side of the sheathing) this assembly **does not** require a specific "vapor resistance" on the interior
- Note that the "thickness" or "R-value" of the exterior sheathing is dependent on the "R-value" in the cavity; in this case a 2x4 cavity insulated to R-13

Dewpoint Test at 30% RH (Chicago) — 2X6 Wall

- Dewpoint temperature of 70°F, 30% RH air is 37°F. Therefore, the temperature of the cavity side of the sheathing (T_s) must be greater than 37°F.
- Temperature of the outside air is the average temperature of December (28°F), January (22°F) and February (27°F) or 25.7°F.

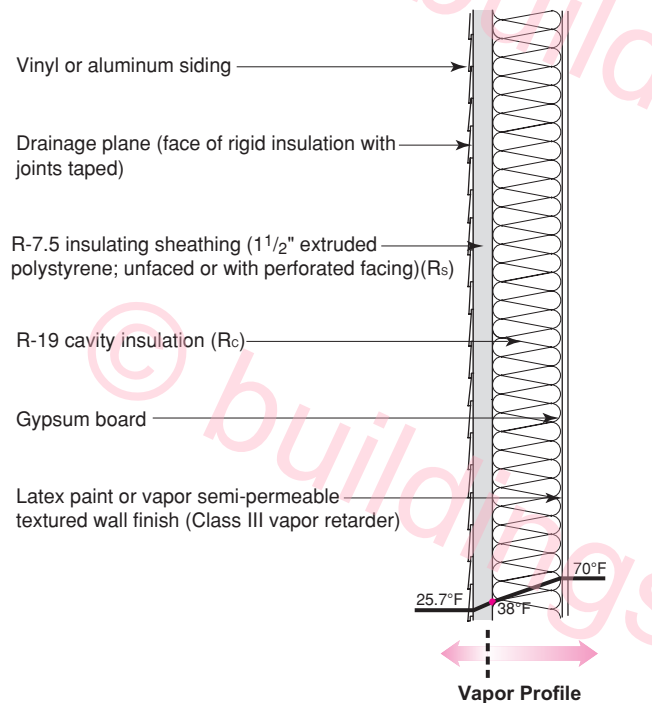

T_i	T_o	ΔT	R_c	R_s	R_t	T_s
70	25.7	44.3	19	7.5	26.5	38

Figure 3b.2
Sheathing/Cladding Assembly Permeance (Wet Cup)

Less than or Equal to 1.0 Perm and Greater than 0.1 Perm — Chicago

- This assembly has some exterior "vapor resistance," but since this resistance is provided by an insulating sheathing that also **sufficiently warms** the "condensing surface" (the cavity side of the sheathing) this assembly **does not** require a specific "vapor resistance" on the interior
- Note that the "thickness" or "R-value" of the exterior sheathing is dependent on the "R-value" in the cavity; in this case a 2x6 cavity insulated to R-19

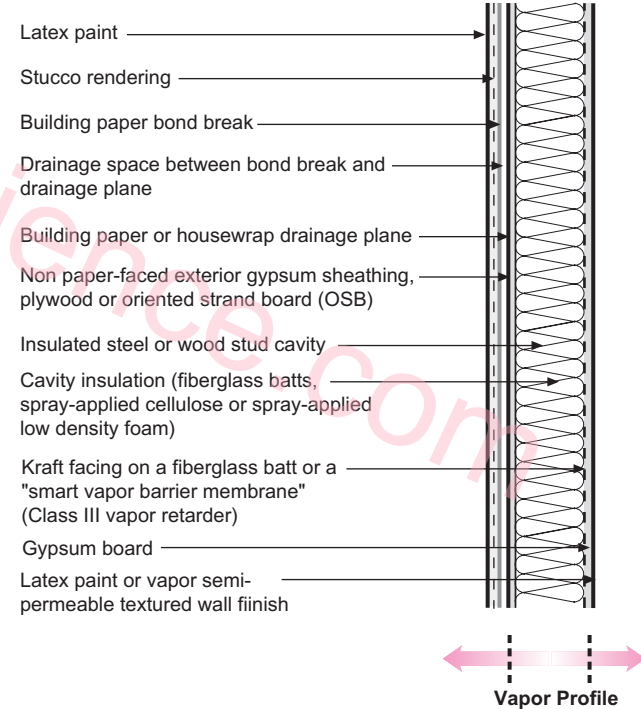

Figure 3c
Sheathing/Cladding Assembly Permeance (Wet Cup)

Less than or Equal to 1.0 Perm and Greater than 0.1 Perm — Chicago

- This assembly has **some** exterior "vapor resistance" and this resistance does not "warm" the "condensing surface" (the cavity side of the sheathing), therefore this assembly **does** require a specific "vapor resistance" on the interior

Dewpoint Test at 35% RH (Chicago) — 2X4 Wall

- Dewpoint temperature of 70°F, 35% RH air is 40°F. Therefore, the temperature of the cavity side of the sheathing (T_s) must be greater than 40°F.
- Temperature of the outside air is the average temperature of December (28°F), January (22°F) and February (27°F) or 25.7°F.

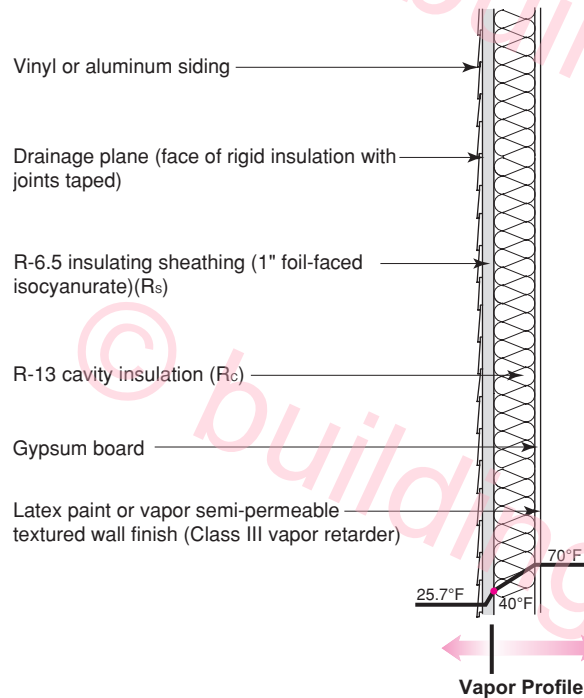

T_i	T_o	ΔT	R_c	R_s	R_t	T_s
70	25.7	44.3	13	6.5	19.5	40

Figure 3d.1
Sheathing/Cladding Assembly Permeance (Wet Cup)
Less than or Equal to 0.1 Perm — Chicago

- This assembly has **significant** exterior "vapor resistance," but since this resistance is provided by an insulating sheathing that also **sufficiently warms** the "condensing surface" (the cavity side of the sheathing) this assembly **does not** require a specific "vapor resistance" on the interior
- Note that the "thickness" or "R-value" of the exterior sheathing is dependent on the "R-value" in the cavity; in this case a 2x4 cavity insulated to R-13

Dewpoint Test at 35% RH (Chicago) — 2X6 Wall

- Dewpoint temperature of 70°F, 35% RH air is 40°F. Therefore, the temperature of the cavity side of the sheathing (T_s) must be greater than 40°F.
- Temperature of the outside air is the average temperature of December (28°F), January (22°F) and February (27°F) or 25.7°F.

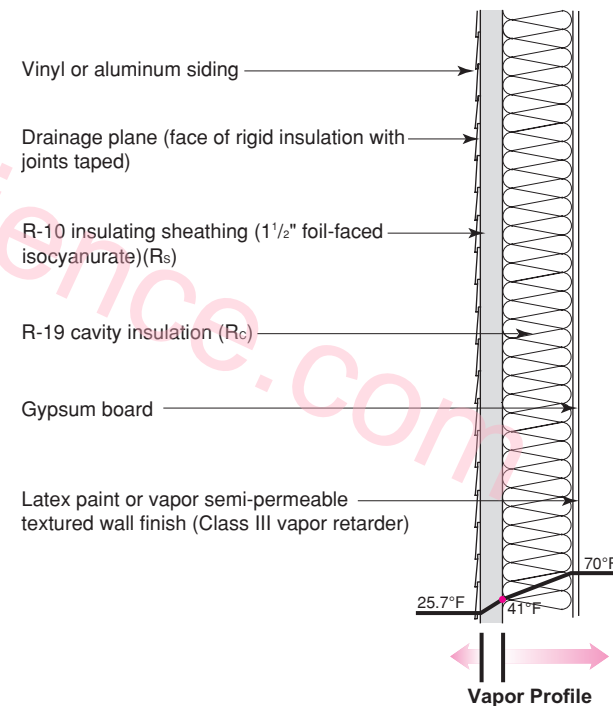

T_i	T_o	ΔT	R_c	R_s	R_t	T_s
70	25.7	44.3	19	10	29	41

Figure 3d.2
Sheathing/Cladding Assembly Permeance (Wet Cup)
Less than or Equal to 0.1 Perm — Chicago

- This assembly has **significant** exterior "vapor resistance," but since this resistance is provided by an insulating sheathing that also **sufficiently warms** the "condensing surface" (the cavity side of the sheathing) this assembly **does not** require a specific "vapor resistance" on the interior
- Note that the "thickness" or "R-value" of the exterior sheathing is dependent on the "R-value" in the cavity; in this case a 2x6 cavity insulated to R-19

Dewpoint Test at 30% RH (Chicago) — 2X4 Wall

- Dewpoint temperature of 70°F, 30% RH air is 37°F. Therefore, the temperature of the cavity side of the sheathing (T_s) must be greater than 37°F.
- Temperature of the outside air is the average temperature of December (28°F), January (22°F) and February (27°F) or 25.7°F.

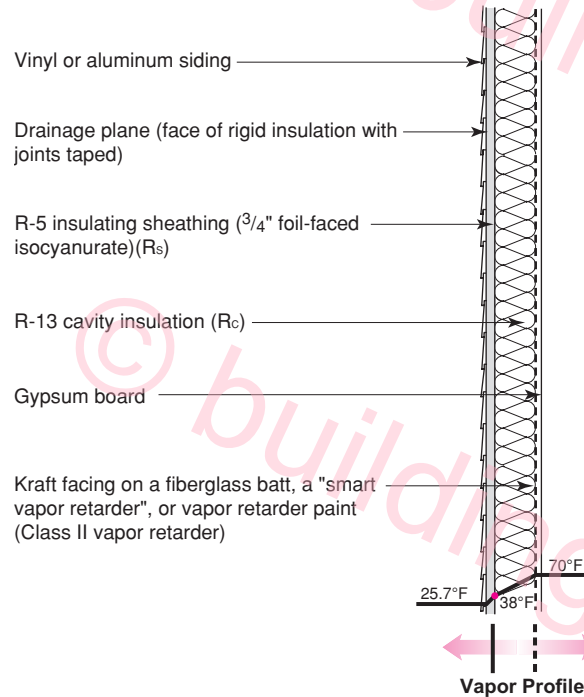

T_i	T_o	ΔT	R_c	R_s	R_T	T_s
70	25.7	44.3	13	5	18	38

Figure 3e.1

Sheathing/Cladding Assembly Permeance (Wet Cup)**Less than or Equal to 0.1 Perm — Chicago**

- This assembly has **significant** exterior "vapor resistance," but since this resistance is provided by an insulating sheathing that "**partially warms**" the "condensing surface" (the cavity side of the sheathing) this assembly **does** require a specific "vapor resistance" on the interior
- Note that the "thickness" or "R-value" of the exterior sheathing is dependent on the "R-value" in the cavity; in this case a 2x4 cavity insulated to R-13

Dewpoint Test at 30% RH (Chicago) — 2X6 Wall

- Dewpoint temperature of 70°F, 30% RH air is 37°F. Therefore, the temperature of the cavity side of the sheathing (T_s) must be greater than 37°F.
- Temperature of the outside air is the average temperature of December (28°F), January (22°F) and February (27°F) or 25.7°F.

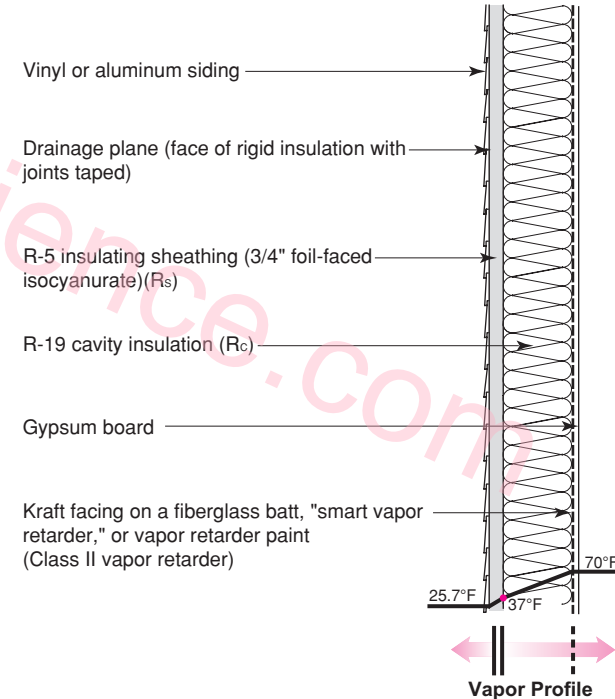

T_i	T_o	ΔT	R_c	R_s	R_T	T_s
70	25.7	44.3	19	6.5	25.5	37

Figure 3e.2

Sheathing/Cladding Assembly Permeance (Wet Cup)**Less than or Equal to 0.1 Perm — Chicago**

- This assembly has **significant** exterior "vapor resistance," but since this resistance is provided by an insulating sheathing that "**partially warms**" the "condensing surface" (the cavity side of the sheathing) this assembly **does** require a specific "vapor resistance" on the interior
- Note that the "thickness" or "R-value" of the exterior sheathing is dependent on the "R-value" in the cavity; in this case a 2x6 cavity insulated to R-19

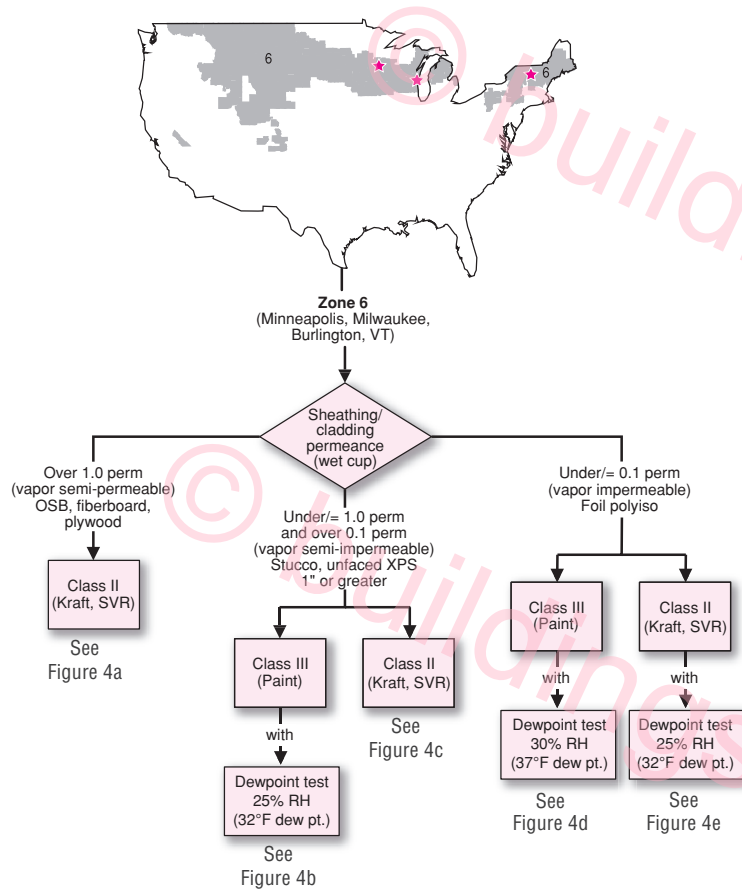

Figure 4
Climate Zone 6 Flow Chart

- Includes Minneapolis, Milwaukee and Burlington, Vermont

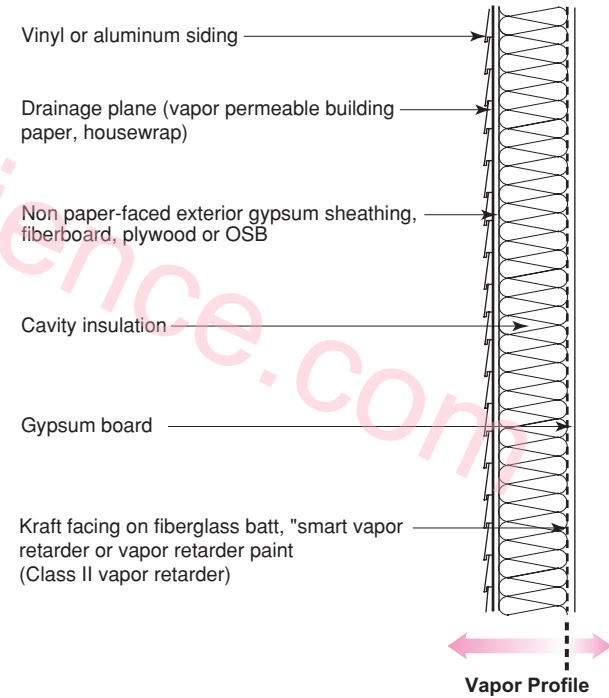
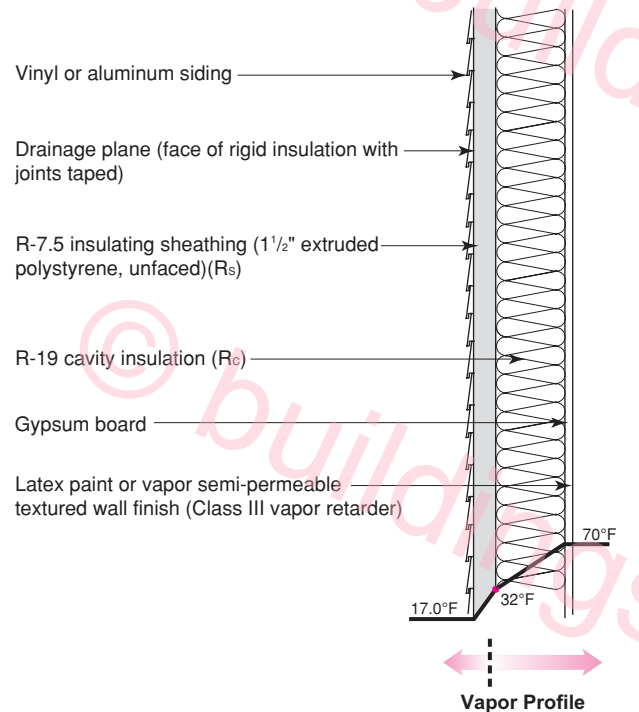

Figure 4a
Sheathing/Cladding Assembly Permeance (Wet Cup) Greater than 1.0 Perm — Minneapolis

- This assembly is very "vapor open" to the exterior, but in the **cold** climate of Minneapolis this assembly **does** require a specific "vapor resistance" on the interior

Dewpoint Test at 25% RH (Minneapolis) — 2X6 Wall

- Dewpoint temperature of 70°F, 25% RH air is 32°F. Therefore, the temperature of the cavity side of the sheathing (T_s) must be greater than 32°F.
- Temperature of the outside air is the average temperature of December (19°F), January (13°F) and February (19°F) or 17.0°F.



T_i	T_o	ΔT	R_c	R_s	R_T	T_s
70	17.0	53.0	19	7.5	26.5	32

Figure 4b
Sheathing/Cladding Assembly Permeance (Wet Cup)

Less than or Equal to 1.0 Perm and Greater than 0.1 Perm — Minneapolis

- This assembly has some exterior "vapor resistance," but since this resistance is provided by an insulating sheathing that also **sufficiently warms** the "condensing surface" (the cavity side of the sheathing) this assembly **does not** require a specific "vapor resistance" on the interior
- Note that the "thickness" or "R-value" of the exterior sheathing is dependent on the "R-value" in the cavity; in this case a 2x6 cavity insulated to R-19

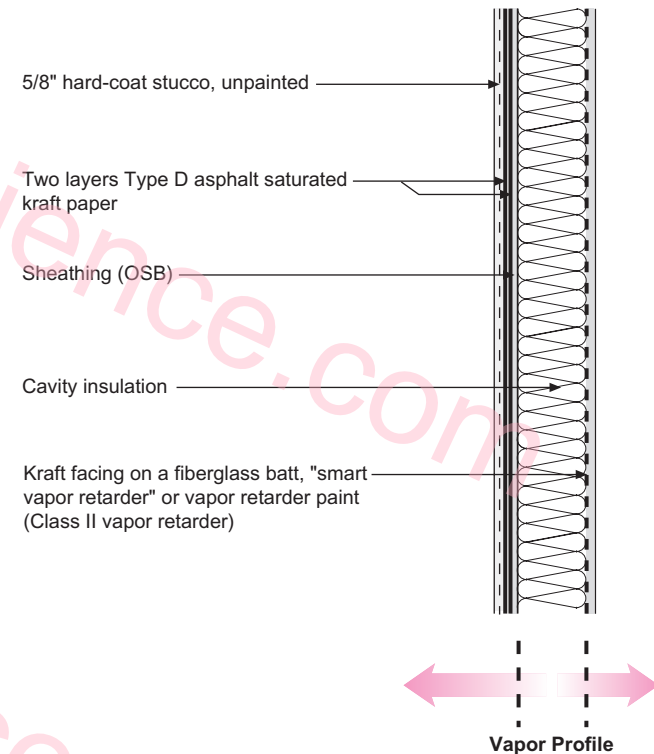

Figure 4c
Sheathing/Cladding Assembly Permeance (Wet Cup)

Less than or Equal to 1.0 Perm and Greater than 0.1 Perm — Minneapolis

- This assembly has **some** exterior "vapor resistance" and this resistance does not "warm" the "condensing surface" (the cavity side of the sheathing), therefore this assembly **does** require a specific "vapor resistance" on the interior

Dewpoint Test at 30% RH (Minneapolis) — 2X6 Wall

- Dewpoint temperature of 70°F, 30% RH air is 37°F. Therefore, the temperature of the cavity side of the sheathing (T_s) must be greater than 37°F.
- Temperature of the outside air is the average temperature of December (19°F), January (13°F) and February (19°F) or 17.0°F.

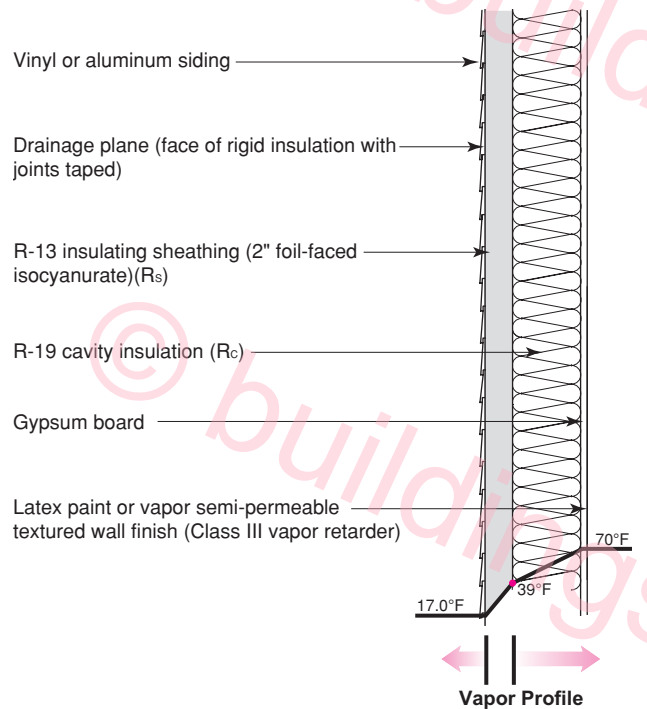

T_i	T_o	ΔT	R_c	R_s	R_t	T_s
70	17.0	53.0	19	13	32	39

Figure 4d
Sheathing/Cladding Assembly Permeance (Wet Cup)
Less than or Equal to 0.1 Perm — Minneapolis

- This assembly has **significant** exterior "vapor resistance," but since this resistance is provided by an insulating sheathing that also **sufficiently warms** the "condensing surface" (the cavity side of the sheathing) this assembly **does not** require a specific "vapor resistance" on the interior
- Note that the "thickness" or "R-value" of the exterior sheathing is dependent on the "R-value" in the cavity; in this case a 2x6 cavity insulated to R-19

Dewpoint Test at 25% RH (Minneapolis) — 2X6 Wall

- Dewpoint temperature of 70°F, 25% RH air is 32°F. Therefore, the temperature of the cavity side of the sheathing (T_s) must be greater than 32°F.
- Temperature of the outside air is the average temperature of December (19°F), January (13°F) and February (19°F) or 17.0°F.

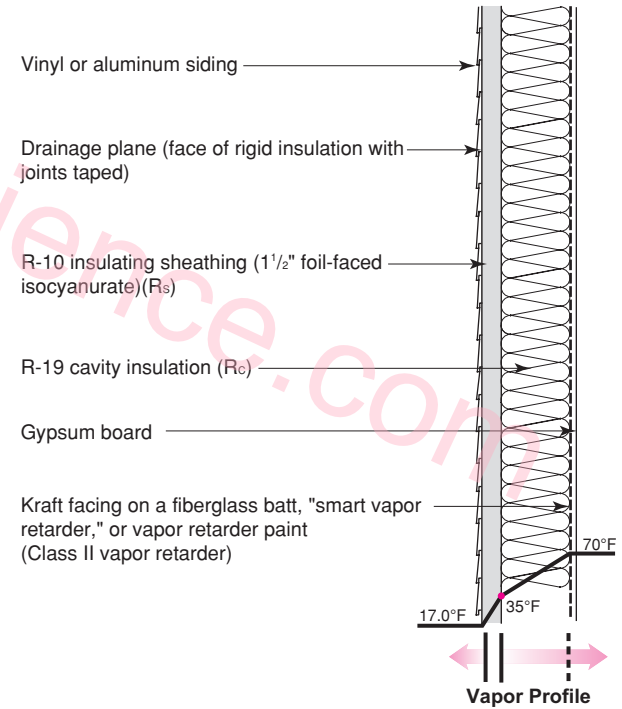

T_i	T_o	ΔT	R_c	R_s	R_t	T_s
70	17.0	53.0	19	10	29	35

Figure 4e
Sheathing/Cladding Assembly Permeance (Wet Cup)
Less than or Equal to 0.1 Perm — Minneapolis

- This assembly has **significant** exterior "vapor resistance," but since this resistance is provided by an insulating sheathing that **partially warms** the "condensing surface" (the cavity side of the sheathing) this assembly **does** require a specific "vapor resistance" on the interior
- Note that the "thickness" or "R-value" of the exterior sheathing is dependent on the "R-value" in the cavity; in this case a 2x6 cavity insulated to R-19

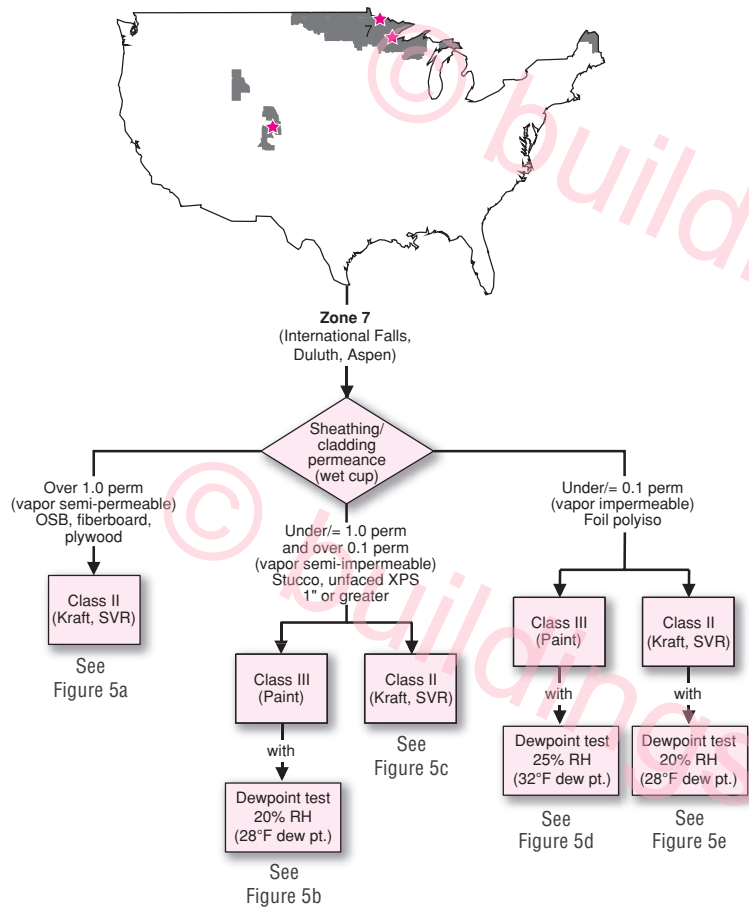

Figure 5
Climate Zone 7 Flow Chart

- Includes International Falls, Duluth and Aspen

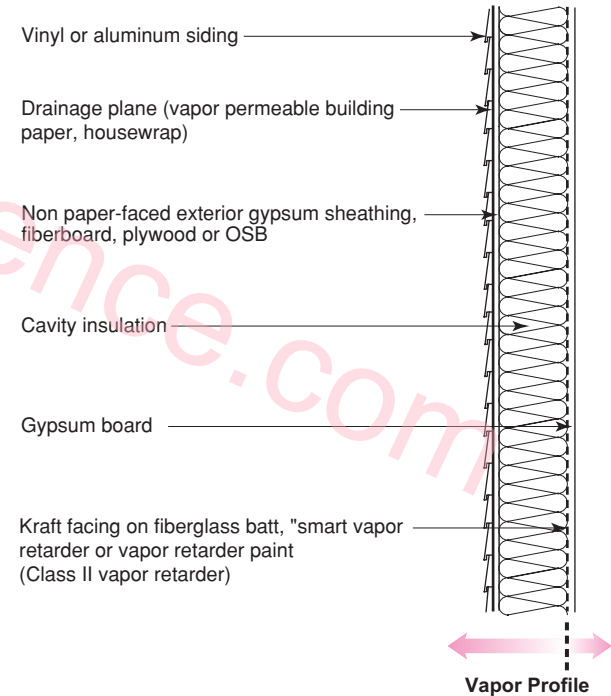

Figure 5a
Sheathing/Cladding Assembly Permeance (Wet Cup) Greater than 1.0 Perm — International Falls

- This assembly is very "vapor open" to the exterior, but in the **very cold** climate as International Falls this assembly **does** require a specific "vapor resistance" on the interior

Dewpoint Test at 20% RH (International Falls) — 2X6 Wall

- Dewpoint temperature of 70°F, 20% RH air is 28°F. Therefore, the temperature of the cavity side of the sheathing (T_s) must be greater than 28°F.
- Temperature of the outside air is the average temperature of December (9°F), January (2°F) and February (9°F) or 6.7°F.

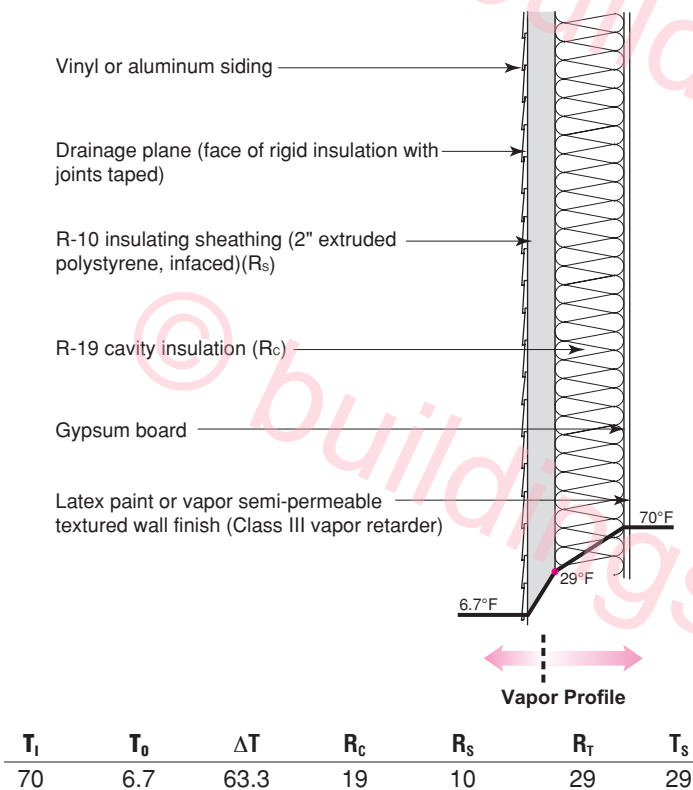

Figure 5b
Sheathing/Cladding Assembly Permeance (Wet Cup) Less than or Equal to 1.0 Perm and Greater than 0.1 Perm — International Falls

- This assembly has some exterior "vapor resistance," but since this resistance is provided by an insulating sheathing that also **sufficiently warms** the "condensing surface" (the cavity side of the sheathing) this assembly **does not** require a specific "vapor resistance" on the interior
- Note that the "thickness" or "R-value" of the exterior sheathing is dependent on the "R-value" in the cavity; in this case a 2x6 cavity insulated to R-19

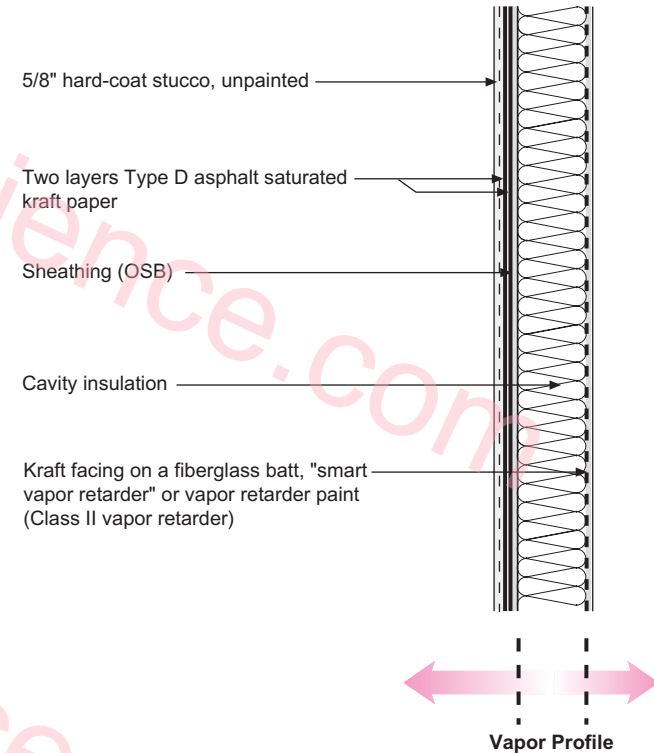
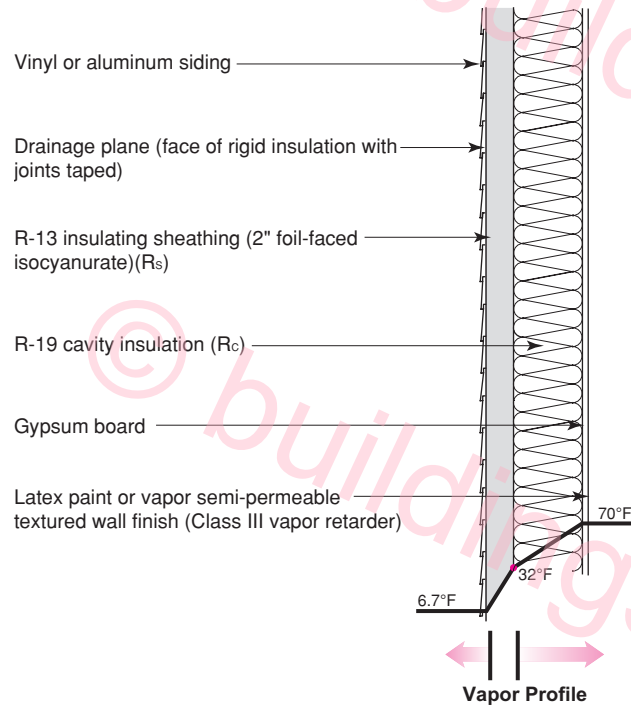

Figure 5c
Sheathing/Cladding Assembly Permeance (Wet Cup) Less than or Equal to 1.0 Perm and Greater than 0.1 Perm — International Falls

- This assembly has **some** exterior "vapor resistance" and this resistance does not "warm" the "condensing surface" (the cavity side of the sheathing), therefore this assembly **does** require a specific "vapor resistance" on the interior

Dewpoint Test at 25% RH (International Falls) — 2X6 Wall

- Dewpoint temperature of 70°F, 25% RH air is 32°F. Therefore, the temperature of the cavity side of the sheathing (T_s) must be greater than 32°F.
- Temperature of the outside air is the average temperature of December (9°F), January (2°F) and February (9°F) or 6.7°F.



T_i	T_o	ΔT	R_c	R_s	R_T	T_s
70	6.7	63.3	19	13	32	32

Figure 5d
Sheathing/Cladding Assembly Permeance (Wet Cup)
Less than or Equal to 0.1 Perm — International Falls

- This assembly has **significant** exterior "vapor resistance," but since this resistance is provided by an insulating sheathing that also **sufficiently warms** the "condensing surface" (the cavity side of the sheathing) this assembly **does not** require a specific "vapor resistance" on the interior
- Note that the "thickness" or "R-value" of the exterior sheathing is dependent on the "R-value" in the cavity; in this case a 2x6 cavity insulated to R-19

Dewpoint Test at 20% RH (International Falls) — 2X6 Wall

- Dewpoint temperature of 70°F, 20% RH air is 28°F. Therefore, the temperature of the cavity side of the sheathing (T_s) must be greater than 28°F.
- Temperature of the outside air is the average temperature of December (9°F), January (2°F) and February (9°F) or 6.7°F.

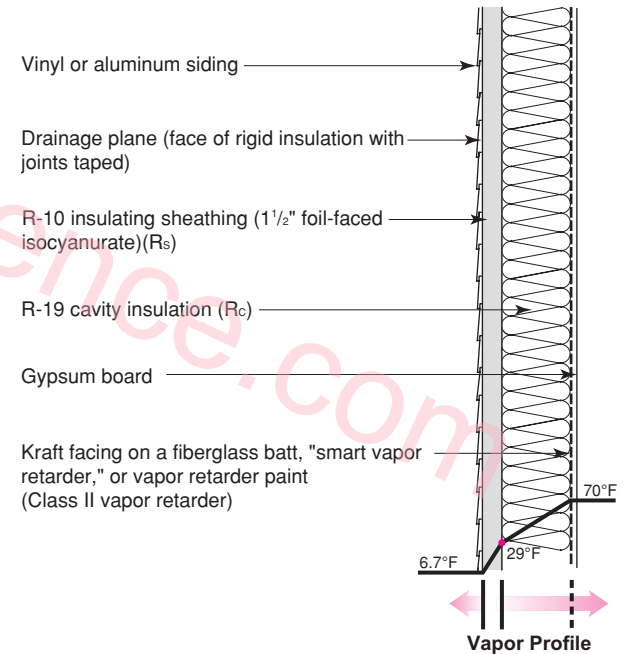

T_i	T_o	ΔT	R_c	R_s	R_T	T_s
70	6.7	63.3	19	10	29	29

Figure 5e
Sheathing/Cladding Assembly Permeance (Wet Cup)
Less than or Equal to 0.1 Perm — International Falls

- This assembly has **significant** exterior "vapor resistance," but since this resistance is provided by an insulating sheathing that **partially warms** the "condensing surface" (the cavity side of the sheathing) this assembly **does** require a specific "vapor resistance" on the interior
- Note that the "thickness" or "R-value" of the exterior sheathing is dependent on the "R-value" in the cavity; in this case a 2x6 cavity insulated to R-19

About the Author

Joseph Lstiburek, Ph.D., P.Eng., is a principal of Building Science Corporation in Westford, Massachusetts. Joe is an ASHRAE Fellow and an internationally recognized authority on indoor air quality, moisture, and condensation in buildings. More information about Joseph Lstiburek can be found at www.buildingscienceconsulting.com.

Direct all correspondence to: Building Science Corporation, 30 Forest Street, Somerville, MA 02143.

Limits of Liability and Disclaimer of Warranty:

Building Science documents are intended for professionals. The author and the publisher of this article have used their best efforts to provide accurate and authoritative information in regard to the subject matter covered. The author and publisher make no warranty of any kind, expressed or implied, with regard to the information contained in this article.

The information presented in this article must be used with care by professionals who understand the implications of what they are doing. If professional advice or other expert assistance is required, the services of a competent professional shall be sought. The author and publisher shall not be liable in the event of incidental or consequential damages in connection with, or arising from, the use of the information contained within this Building Science document.