

# Moisture Management for High R-Value Walls

Building America Report - 1316

November 2013

Robert Lepage, Chris Schumacher and Alex Lukachko

---

Abstract:

*This report explains the moisture-related concerns for high R-value wall assemblies and discusses past Building America research work that informs this study. Hygrothermal simulations were prepared for several common approaches to high R-value wall construction in six U.S. cities (Houston, Atlanta, Seattle, St. Louis, Chicago, and International Falls) representing a range of climate zones (2, 3, 4C, 4, 5A, and 7, respectively). The simulations are informed by experience gained from past research in this area and validated by field measurement and forensic experience.*

---

# Moisture Management for High R-Value Walls

R. Lepage, C. Schumacher, and  
A. Lukachko  
*Building Science Corporation*

November 2013

## NOTICE

This report was prepared as an account of work sponsored by an agency of the United States government. Neither the United States government nor any agency thereof, nor any of their employees, subcontractors, or affiliated partners makes any warranty, express or implied, or assumes any legal liability or responsibility for the accuracy, completeness, or usefulness of any information, apparatus, product, or process disclosed, or represents that its use would not infringe privately owned rights. Reference herein to any specific commercial product, process, or service by trade name, trademark, manufacturer, or otherwise does not necessarily constitute or imply its endorsement, recommendation, or favoring by the United States government or any agency thereof. The views and opinions of authors expressed herein do not necessarily state or reflect those of the United States government or any agency thereof.

Available electronically at <http://www.osti.gov/bridge>

Available for a processing fee to U.S. Department of Energy  
and its contractors, in paper, from:

U.S. Department of Energy  
Office of Scientific and Technical Information  
P.O. Box 62  
Oak Ridge, TN 37831-0062  
phone: 865.576.8401  
fax: 865.576.5728

email: <mailto:reports@adonis.osti.gov>

Available for sale to the public, in paper, from:

U.S. Department of Commerce  
National Technical Information Service  
5285 Port Royal Road  
Springfield, VA 22161  
phone: 800.553.6847  
fax: 703.605.6900

email: [orders@ntis.fedworld.gov](mailto:orders@ntis.fedworld.gov)

online ordering: <http://www.ntis.gov/ordering.htm>



Printed on paper containing at least 50% wastepaper, including 20% postconsumer waste

## Moisture Management for High R-Value Walls

Prepared for:

The National Renewable Energy Laboratory  
On behalf of the U.S. Department of Energy's Building America Program  
Office of Energy Efficiency and Renewable Energy  
15013 Denver West Parkway  
Golden, CO 80401  
NREL Contract No. DE-AC36-08GO28308

Prepared by:

R. Lepage, C. Schumacher, and A. Lukachko  
Building Science Corporation  
30 Forest Street  
Somerville, MA 02143

NREL Technical Monitor: Cheryn Metzger

Prepared under Subcontract No. KNDJ-0-40337-04

November 2013

**(This page left blank)**

## Contents

List of Figures .....	vi
List of Tables .....	vii
Definitions.....	viii
Executive Summary .....	ix
<b>1 Introduction.....</b>	<b>1</b>
1.1 Problem Statement.....	1
1.1.1 Definition and Classification of High R-Value Walls .....	2
1.1.2 Sources of Moisture for High R-Value Walls.....	4
1.2 Past Building America Research .....	5
1.3 Research Questions .....	7
<b>2 Modeling Methods .....</b>	<b>8</b>
2.1 Technical Approach.....	8
2.1.1 Selection of High-R Walls .....	8
2.1.2 Hygrothermal Simulations .....	19
2.1.3 Metrics for Analysis.....	30
2.1.4 Climates, Locations, and Boundary Conditions .....	32
2.1.5 Building Enclosure Selection.....	33
2.1.6 Simulation of Moisture Loads .....	33
<b>3 Results and Discussion .....</b>	<b>36</b>
3.1 Limits of Vapor Diffusion and Air Leakage.....	36
3.2 Indoor Relative Humidity and Air Leakage.....	37
3.3 Interior Vapor Barriers.....	38
3.4 Wall Performance .....	38
3.4.1 Advance Framed Walls With Exterior Insulation.....	39
3.4.2 Hybrid Advance Framed Walls With 2 in. of Exterior Insulation, 2 in. of ccSPF, and 3.5 in. of Batt Insulation.....	43
3.4.3 Advance Framed Walls With 7.25 in. of ccSPF Cavity Insulation .....	46
3.4.4 Double Stud Walls With CFI and Polyethylene Vapor Barrier .....	49
3.4.5 Hybrid-Insulated Double Stud Walls With ccSPF and CFI.....	54
3.4.6 Double Stud Wall With ocSPF Cavity Insulation.....	58
3.4.7 Truss Wall With CFI Insulation and Polyethylene Vapor Barrier.....	62
3.4.8 Structural Insulated Panels.....	65
3.4.9 Concrete Block Wall With 3.5 in. of Exterior Insulated Finishing System.....	68
3.5 Wall Summary .....	70
3.6 Cost Considerations .....	71
<b>4 Recommendations and Conclusions .....</b>	<b>74</b>
4.1 Future Considerations .....	76
References .....	77
Appendix A: Representative Detail Drawings .....	80
Appendix B: Inputs for Hygrothermal Simulations .....	101

## List of Figures

Figure 1. Common approaches to high R-value enclosures .....	4
Figure 2. Wall 1: Exterior insulation on advance framed wall .....	11
Figure 3. Wall 2: Exterior insulation on hybrid advance framed wall .....	12
Figure 4. Wall 3: Advance framed wall with ccSPF cavity insulation .....	13
Figure 5. Wall 4: Double stud wall with fully installed cellulose fiber insulation (CFI).....	14
Figure 6. Wall 5: Hybrid-insulated double stud wall with 2-in. of ccSPF and CFI fill .....	15
Figure 7. Wall 6: Double stud wall with 9.5 in. of ocSPF .....	16
Figure 8. Wall 7: Truss wall with 9.5 in. of CFI fill .....	17
Figure 9. Wall 8: SIP wall .....	18
Figure 10. Wall 9: CMU wall with EIFS .....	19
Figure 11. Wall section 1: Advance framed wall with 4 in. of exterior insulation.....	21
Figure 12. Wall section 2: Advance framed wall with 2 in. of exterior insulation, 2 in. of ccSPF, and 3.5 in. of batt insulation .....	22
Figure 13. Wall section 3: Advance framed wall with 7.25 in. ccSPF cavity insulation .....	23
Figure 14. Wall section 4: Double stud wall with 9.5 in. of CFI .....	24
Figure 15. Wall section 5: Double stud wall with 2 in. of ccSPF and 7.5 in. of CFI .....	25
Figure 16. Wall section 6: Double stud wall with 9.5 in. of ocSPF .....	26
Figure 17. Wall section 7: Truss wall with 9.5 in. of CFI .....	27
Figure 18. Wall section 8a: SIP wall with 11.25 in. of EPS .....	28
Figure 19. Wall section 8b: SIP joint .....	29
Figure 20. Peak daily MCs for advance framed wall insulated walls in modeled locations .....	40
Figure 21. Advance framed wall insulated walls construction moisture drying .....	41
Figure 22. Advance framed wall insulated walls peak MC with air leakage condensation .....	42
Figure 23. Bulk water leak in advance framed walls with exterior insulation.....	43
Figure 24. Peak daily MC for hybrid advance framed wall insulated walls in modeled cities .....	44
Figure 25. Hybrid advance framed wall insulated walls construction moisture drying .....	45
Figure 26. Peak daily MC for hybrid advance framed wall insulated walls with air leakage in modeled cities.....	46
Figure 27. Peak daily MCs for advance framed wall insulated walls with ccSPF cavity insulation in modeled cities.....	47
Figure 28. Advance framed wall with ccSPF cavity insulation construction moisture drying .....	48
Figure 29. Peak daily MCs for advanced frame wall insulated walls with ccSPF cavity insulation and air leakage in modeled cities .....	49
Figure 30. Peak MCs for double stud walls in modeled cities.....	50
Figure 31. Double stud walls construction moisture drying .....	51
Figure 32. Peak MCs for double stud walls in modeled cities, with and without air leakage .....	52
Figure 33. Bulk water leak in double stud walls with exterior insulation.....	53
Figure 34. Cellulose MC for bulk water leak in Chicago .....	54
Figure 35. Peak MCs for hybrid double stud walls with ccSPF in modeled cities after 3 years.....	55
Figure 36. Hybrid-insulated double stud walls construction moisture drying .....	56
Figure 37. Peak MC for double stud walls with ccSPF in modeled cities, with and without air leakage.....	57
Figure 38. Bulk water leak in hybrid double stud walls .....	58
Figure 39. Peak MC for double stud walls with ocSPF in modeled cities .....	59
Figure 40. Annual peak daily MCs for 40% and 20% indoor RH in Chicago .....	59
Figure 41. Construction moisture in double stud walls with ocSPF .....	60
Figure 42. Peak MCs for double stud walls with ocSPF in modeled cities, with and without air leakage.....	61
Figure 43. Bulk water leak in double stud walls with ocSPF .....	62
Figure 44. Peak MCs for truss walls in modeled cities .....	63
Figure 45. Truss walls construction moisture drying .....	63
Figure 46. Peak MCs for truss walls with in modeled cities, with and without air leakage.....	64
Figure 47. Peak MCs for SIPs walls in modeled cities .....	65

Figure 48. SIP walls construction moisture drying ..... 66  
 Figure 49. Peak MCs for SIP walls in modeled cities, with and without air leakage ..... 67  
 Figure 50. Yearly peak daily RHs at the GWB surface for CMU walls— baseline, air leakage, and air leakage and vinyl wallpaper ..... 69  
 Figure 51. CMU wall with 3.5 in. of EIFS construction moisture drying ..... 70

*Unless otherwise noted, all figures were created by BSC.*

## List of Tables

Table 1. Current Recommended "Whole-Wall" Minimum R-Value<sup>a</sup> Including Thermal Bridging ..... 3  
 Table 2. Wall Comparison Chart (Straube and Smegal, 2009a)..... 10  
 Table 3. Biodegradative Organisms and Mechanisms..... 30  
 Table 4. Simulated Cities and Heating Degree Day and Cooling Degree Day Data ..... 32  
 Table 5. Summer and Winter Indoor Conditions..... 32  
 Table 6. Boundary Conditions ..... 33  
 Table 7. Air Leakage Rate Conversions..... 34  
 Table 8. Peak Daily MCs for Exterior Insulated Wall Assembly, With Class I and III Vapor Barriers37  
 Table 9. Peak Daily MCs for Cavity Insulated Wall Assembly, With Class I and III Vapor Barriers.. 37  
 Table 10. Exterior Insulation Requirements and Alternates for the Use of Class III Vapor Retarders39  
 Table 11. Insulation Ratio for a Given Interior RH and Outdoor Temperature ..... 40  
 Table 12. Advance Framed Wall With Exterior Insulation Drying Times To Reach 20% MC ..... 42  
 Table 13. Hybrid Advance Framed Wall Drying Times To Reach 20% MC..... 45  
 Table 14. Advance Framed Wall With ccSPF Cavity Insulation Drying Times To Reach 20% MC ... 48  
 Table 15. Double Stud Walls Drying Times To Reach 20% MC ..... 51  
 Table 16. Hybrid-Insulated Double Stud Wall Drying Times To Reach 20% MC ..... 56  
 Table 17. Double Stud Wall With ocSPF Drying Times To Reach 20% MC..... 60  
 Table 18. Truss Wall Drying Times To Reach 20% MC ..... 64  
 Table 19. Hybrid Advanced Frame Wall Drying Times To Reach 20% MC..... 66  
 Table 20. Moisture Durability Risk for Proposed Wall Assemblies in Select Climate Zones, Including Air Leakage ..... 71  
 Table 21. Total and Area Cost for Advance Framed High-R Walls<sup>1</sup> ..... 72  
 Table 22. Total and Area Cost for Double Stud High-R Walls<sup>1</sup> ..... 73

*Unless otherwise noted, all tables were created by BSC.*



## Definitions

ACH	Air changes per hour
BSC	Building Science Corporation
ccSPF	Closed cell spray polyurethane foam
CFI	Cellulose fiber insulation
CMU	Concrete masonry unit
EIFS	Exterior insulation and finish system
EPS	Expanded polystyrene
GWB	Gypsum wall board
IRC	International Residential Code
MC	Moisture content
o.c.	On center
ocSPF	Open cell spray polyurethane foam
OSB	Oriented strand board
PIC	Polyisocyanurate
RH	Relative humidity
SIP	Structural insulated panel
WRB	Water resistive barrier
WUFI	Wärme und Feuchte instationär
XPS	Extruded polystyrene

## Executive Summary

In recent years, rising energy costs, energy security concerns, and social change have generated increased demand for better thermal performance. Building standards and construction codes have required higher minimum R-values. High-R assemblies, however, can be more susceptible to moisture problems. Different design considerations, construction techniques, and strategies are needed to ensure long-term service and durability of these assemblies.

The following report explains the moisture-related concerns for high R-value wall assemblies and discusses past Building America research work that informs this study. Hygrothermal simulations were prepared for several common approaches to high R-value wall construction in six U.S. cities (Houston, Atlanta, Seattle, St. Louis, Chicago, and International Falls) representing a range of climate zones (2, 3, 4C, 4, 5A, and 7, respectively). The simulations are informed by experience gained from past research in this area and validated by field measurement and forensic experience.

The modeling program was developed to assess the moisture durability of the wall assemblies based on three primary sources of moisture: construction moisture, air leakage condensation, and bulk water leakage. The peak annual moisture content of the wood-based exterior sheathing was used to comparatively analyze the response to the moisture loads for each of the walls in each given city. Walls that experienced sheathing moisture contents between 20% and 28% were identified as risky, whereas those exceeding 28% were identified as very high risk.

All of the wall assemblies perform well under idealized conditions. However, only the walls with exterior insulation, or cavity insulation that provides a hygrothermal function similar to exterior insulation, perform adequately when exposed to moisture loads. Walls with only cavity insulation are particularly susceptible to air leakage condensation. None of the walls performed well when a precipitation-based bulk water leak was introduced to the backside of the sheathing, emphasizing the importance of proper flashing details.

This report is intended for designers and builders who are concerned about best practices for moisture management in high R-value walls, and for researchers who may need to assess other high R-value assemblies.

# 1 Introduction

## 1.1 Problem Statement

Rising costs of energy, concerns relating to climate change, and demands for increased comfort have led to the desire for increased insulation levels in many new buildings. However, increasing the insulation used in new construction may lead to increased problems in managing moisture. Depending on the insulation strategy, new construction techniques and strategies may need to be employed to ensure that external and internal moisture sources are properly handled, such that moisture-sensitive materials are protected and maintained at safe levels.

Reducing the heat flow across an enclosure (by increasing insulation levels) may decrease its durability relative to standard construction, depending on how that heat flow reduction is achieved. High R-value walls are no different. By adding insulation inside of wood sheathing or cladding, the moisture content (MC) of the sheathing or cladding will rise in cold weather, the risk of condensation increases significantly, and outward drying potential is reduced. Adding insulation also increases the risk of condensation in the summertime only if cooling is present, whether by natural heating, ventilation, and air conditioning (HVAC) systems or natural cooling, but in this circumstance on the exterior side of the interior finish, especially if the interior finish is vapor impermeable (vapor barriers, cabinets, mirrors, etc.). In short, pressure to increase energy efficiency has a potential “systems effect” on the moisture-related performance of new and existing housing, and this impact must be understood to mitigate unexpected and unintended performance and durability problems.

The risk of moisture damage depends on a number of factors, including climate (seasonal changes, orientation, exposure) and interior conditions (temperature, relative humidity [RH], pressurization), as well as particulars of the wall assembly such as cladding type, the presence or absence of a ventilation and drainage gap behind the cladding, the sheathing material, the type and location of insulation material, the vapor permeance of various layers (including vapor control layers and finishes), and the sensitivity of the assembly to workmanship errors, movement over time, and environmental changes. The range of factors involved makes understanding and predicting moisture-related performance a complicated activity.

A significant amount of laboratory and field research has been conducted to better understand the moisture performance of materials, subassemblies, and enclosure systems. A significant amount of research is still underway; however, research is increasingly conducted by the private sector and is not immediately made available to those who are designing and building. At the same time, insulation and airtightness standards continue to become more stringent while the number of available building materials and systems continues to increase. Designers and builders, faced with greater demands and more options, are now seeking more information and guidance from manufacturers, consultants, and standards organizations; however, real physical testing, analysis, and reporting have not kept up with the industry demand for information and guidance.

For interim guidance, the fundamental physics of moisture properties and motion in building components and systems, complemented with empirical evidence and observations, can be applied to infer the moisture-related problems in existing and proposed buildings. Sophisticated hygrothermal simulation tools have been developed. When the limitations of the simulations are

understood, and the simulation results are calibrated against field and laboratory measurements, these tools can extend our ability to make recommendations.

This paper builds on past research work and building science theory and uses hygrothermal simulations to examine the moisture sensitivity of select high-R wall systems to boundary conditions and design decisions. Section 1 provides the background for the study and presents the research questions addressed by the work. Section 2 explains how the range of potential factors was limited to significant cases and describes the approach to the hygrothermal simulations. Section 3 presents the results of the study and Section 4 provides recommendations, including climate-specific guidance and drawings to describe appropriate construction assemblies.

### **1.1.1 Definition and Classification of High R-Value Walls**

The term *high R-value enclosure* attempts to bring together what is known about delivering exceptionally good control of heat flow through walls, roofs, windows, and foundations. High R-value enclosures are more than just assemblies with an increased amount of insulation. These enclosures are systems that are airtight, have little thermal bridging, manage solar heat gain, ensure human comfort, are buildable at production scale, and provide moisture control to ensure durability and health expectations are met.

There are no widely accepted definitions of the terms *high R* and *high R-value*, but they are usually understood as providing higher thermal control than the building code mandates. For the purposes of this report, a high-R enclosure provides an effective R-value that meets or exceeds those listed in Table 1, but also meets high standards for buildability, durability, health, and comfort.

R-value is commonly used in reference to the thermal resistance of insulation products. However, this metric does not account for the impacts of thermal bridging, air leakage, installation quality, and thermal mass—i.e., it does not account for many of the factors that affect thermal performance in real-world structures. It is this multitude of factors that work together to deliver good thermal control. Oak Ridge National Laboratory has proposed “whole-wall R-value,” which is the R-value for the whole opaque wall including the thermal performance of not only the “clear wall” area, but also all typical envelope interface details. Although this does not account for all of the impacts listed above, it is a better indicator of performance.

In 2009, Building Science Corporation (BSC) was tasked with preparing a Building America white paper on high thermal performance enclosures (Straube, 2010). This paper defined performance requirements, reviewed past and current research, and outlined the research gaps in this area, including the need to demonstrate and document methods to achieve high levels of thermal performance and airtightness. Table 1 below provides BSC’s recommended “whole-wall” minimum R-value for different enclosure components for each climate zone. The column highlighted in red shows the minimum “whole-wall” R-values that are used in this report as the current minimum standard for high R-value wall assemblies.

**Table 1. Current Recommended "Whole-Wall" Minimum R-Value<sup>a</sup> Including Thermal Bridging**  
(Straube 2010)

Climate Zone	Wall	Vented Attic	Compact Roof	Basement Wall	Exposed Floor	Slab Edge <sup>b</sup>	Windows (U/SHGC)	Sub-slab <sup>c</sup>
1	10	40	35	5	10	none	yes	none
2	15	50	40	10	20	5	0.35/<.25	none
3	20	50	45	10	20	7.5	0.30/<.3	5
4	25	60	45	15	30	7.5	0.30/<.35	7.5
5	30	65	50	15	30	10	0.24/<.50	7.5
6	35	75	60	20	40	10	0.18/--	10
7	40	90	65	25	45	15	0.15/--	15
8	50	100	75	35	50	20	0.15/--	20

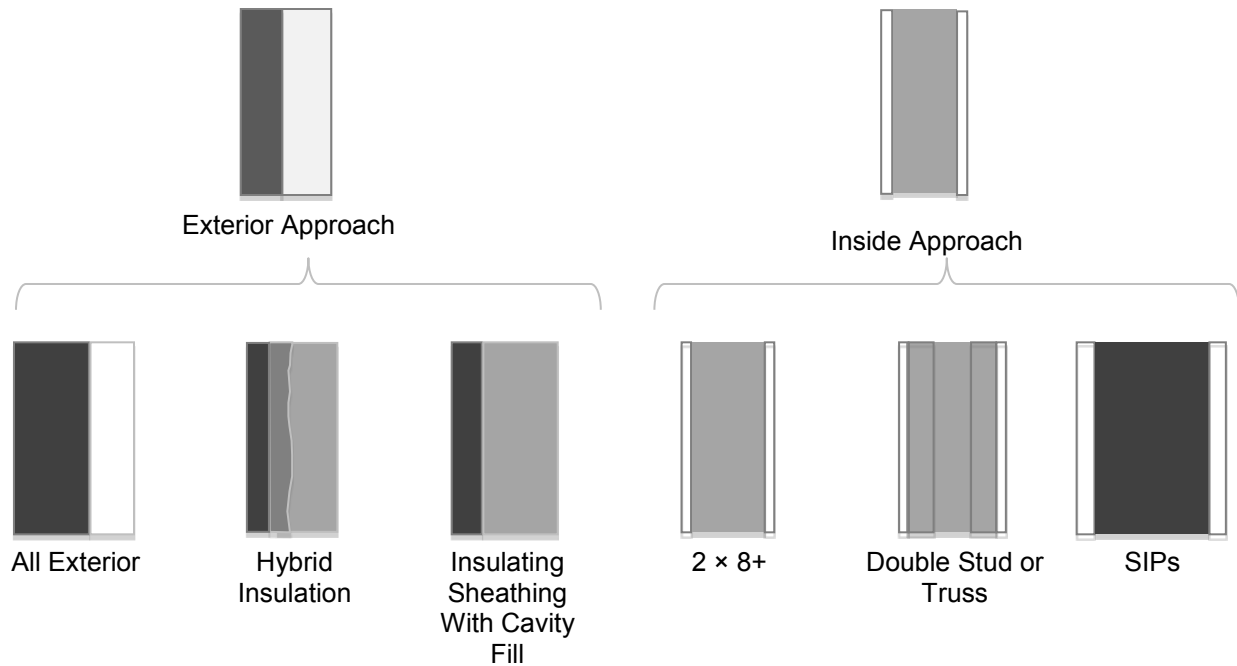
<sup>a</sup> These are recommended values based on experience - see economics section

<sup>b</sup> Slab edge insulation includes all of stem wall or monolithic slab edge

<sup>c</sup> Full area coverage of slabs

A broad classification of the approaches to high R-value enclosures for cold climate residential buildings was suggested in a recent Building America study (Lukachko et al. 2012). Figure 1 below describes two common approaches: adding insulation to the exterior of the building structure (i.e., the “exterior” approach), which may include insulation materials inside the structural cavity or none at all; and adding more insulation inside the structural cavity (i.e., the “inside” approach), which uses different types of insulation material and an increased width of the cavity to reach higher R-value levels. Walls are illustrated in Figure 1, but the classification could also apply to other enclosure components with a few modifications.

For each of the approaches in Figure 1, there are additional modifications depending on choice of insulation material and the thickness of the wall or of various layers in the assembly. Different enclosure assemblies will have different requirements to meet or exceed current durability expectations, but recommendations can be made at this level of classification. In general, drained and ventilated claddings, exterior insulating sheathing, and high airtightness combine to provide an enclosure that is more durable even when insulated to high levels.



**Figure 1. Common approaches to high R-value enclosures**

Notes for Figure 1:

1. The left-hand side is the “outside climate” and the right-hand side is the “inside climate.”
2. Dark gray is rigid insulation, medium gray is spray foam insulation, light gray is cavity fill insulation, and white is open structure.

### **1.1.2 Sources of Moisture for High R-Value Walls**

Enclosure assemblies are subject to moisture loads from a number of sources including bulk water (introduced by leakage), built-in moisture, water vapor (introduced by vapor diffusion or air leakage), and capillary transport through materials in contact with water or in contact with the ground. Different approaches to high R-value construction are affected differently by each source. The moisture sources are described below.

#### **1.1.2.1 Bulk Water**

The largest potential moisture source in wall assemblies is bulk water leakage. Bulk water is introduced at the exterior of wall assemblies in the form of rainwater and meltwater (from ice and snow). The means and methods to prevent the bulk water penetration and moisture damage are well developed and understood. Roof overhangs and wall surface features prevent rainwater from pooling or standing on the exterior surface. Flashings prevent bulk water penetration at interfaces, at openings (e.g., windows and hatches), and at service penetrations (plumbing and electrical stacks, air intake and exhaust vents, etc.) (Lstiburek 2006). Exposure to bulk water can also be indirect: splash-back from hard surfaces at the base of the wall and surface runoff from grade or roof areas sloping toward the wall are common problems.

#### **1.1.2.2 Built-in Moisture**

Moisture is said to be “built-in” when damp or wet materials are enclosed in an assembly during construction. Built-in moisture can be introduced through the use of wet materials or through unprotected materials that are wet by rain or meltwater during construction. Builders in areas

with high hours of annual rainfall are likely to have a high level of awareness of this issue and in some areas (the Pacific Northwest coast, for example), building regulations require spot measurements to verify that the MC of the wood framing is below critical levels before construction is allowed to be closed in.

### *1.1.2.3 Water Vapor*

Another moisture source, water vapor, is often considered but not as well understood. Through the winter months in cold and mixed climates the indoor air can be a significant source of water vapor. Water vapor moves through and into the assembly by two mechanisms: vapor diffusion and airflow. Methods to control vapor diffusion and air movement are well documented (Latta 1973; Hutcheon and Handegord 1985; Quirouette 1985; Straube and Burnett 2005) but are unfortunately rarely well executed. Airflow is capable of transporting hundreds of times more moisture than vapor diffusion (Wilson 1961); hence, it is important to control airflow to prevent moisture problems and ensure the durability of the building enclosure.

### *1.1.2.4 Capillary Transport*

Movement of moisture by capillary action occurs through the interconnected network of pores in a hygroscopic material or between two adjoining hydrophilic materials due to the attractive force of surface tension. Capillary transport through joints is significant only in gaps of less than about  $\frac{1}{8}$  in. (3 mm) but can occur in a broad range of building materials such as concrete, clay brick masonry, and wood. Wall assemblies in direct contact with a concrete foundation can be at risk of wetting by this mechanism unless protected by a capillary break created by a nonporous or hydrophobic material.

Solutions exist to control these moisture sources and maximize assembly durability. Solutions include: use insulation exterior to any sheathing, use lower permeance insulating exterior sheathing, build a ventilation space outside of the sheathing or behind the cladding, build a more airtight enclosure, provide better rainwater management (e.g., drained subsill flashing), etc. These solutions are considered and explained in Sections 3 and 4 of this report.

## **1.2 Past Building America Research**

The increased risk for moisture damage in insulated wall assemblies is well understood by researchers (Rose 2005; Straube and Burnett 2005; Hutcheon and Handegord 1985), but it is not well understood by the code and building communities.

When the thermal resistance of a wall assembly is increased, wood-based sheathings and some sidings (particularly wood and fiber cement) are placed at a higher risk of moisture damage (Lstiburek 2010). Field experience with certain types of high-R enclosures (e.g., structural insulated panels (SIPs) and double stud walls and dense-pack roof assemblies) have shown that wetting due to small errors (for example, rain leaks or convective loops) can occur and, since drying is very slow (due to increased airtightness, decreased heat flux, and the introduction of vapor impermeable layers), high RH and moisture content (MC) persist for longer periods and there is a heightened risk of damage (Straube and Burnett, 2005).

In 2009 and 2010, BSC conducted a series of studies, each focusing on a different part of the building enclosure. These included reports for high R-value walls (Smegal and Straube 2009), high R-value foundations (Straube and Smegal 2010), and high R-value roofs (Straube and Grin

2010). Each report looked at thermal control, but also moisture control, durability, buildability, cost, and material use, for common high R-value assembly designs. Analysis conducted for these reports sought to identify high R-value assemblies that were likely to be implemented at a production scale and that were also designed to minimize durability risks.

A study conducted by IBACOS in 2010 (Broniek et al. 2010) also evaluated different approaches to the construction of high R-value wall assemblies. This study included a comparison of simulation results using a whole-house energy model and collected experience with construction issues through consultation with builders and manufacturers, and through the construction of full-scale mockups. In addition to some of the same performance criteria examined in the BSC study above, IBACOS looked at architectural flexibility (i.e., the ability of the wall system to accommodate a wide range of floor plans and finishes) and scalability to mass production in multiple climate zones.

Field research projects have been conducted by Building America teams to assess different approaches to high R-value enclosures in number of climate zones. Some recent BSC examples include:

- The Westford Habitat for Humanity project in Westford, Massachusetts
- Research with Transformations, Inc. at three developments in Massachusetts
- The NIST Net Zero Energy Lab House in Gaithersburg, Maryland
- The Neighborhood Stabilization Program 2 community in Wyandotte, Michigan.

The Westford Habitat project used a 4-in. layer of insulating sheathing outside of advance framed 2 × 6 walls and 4 in. of insulating sheathing over engineered wood rafters (i.e., the “exterior” insulating sheathing approach, see Figure 1). With the cavity fill insulation included, this prototype house has nominal R-44 walls, R-66 roof insulation, R-26 basement wall insulation, R-10 under the basement floor slab, and a whole-house airtightness of 1.5 ACH50. Important lessons were learned during the construction of wall and roof assemblies with thick layers of exterior insulation, including special details for window and door installation (Lstiburek 2009; BSC 2010a).

The Transformations, Inc. project involved three communities of houses that employ a 12-in. thick double stud wall assembly to achieve a high R-value enclosure (i.e., the “inside” double stud approach, see Figure 1). The double stud approach is favored by some builders because it allows for the use of low-cost cavity fill insulation materials (instead of more expensive board foam and spray foam insulation materials). Double stud walls, however, are at a higher risk of moisture-related problems than walls constructed using the insulating sheathing (exterior) approach. The moisture risks associated with this approach have been documented as part of the high R-value Wall study (Straube and Smegal, 2009a) and the Transformations project continues to assess this issue with long-term field measurement of a side-by-side comparison between full-cavity ocSPF and full-cavity netted and dry blown-in cellulose (BSC 2010b; Ueno et al. 2012).

The NIST Net Zero Energy Lab House was designed primarily to test mechanical and renewable energy systems inside an ultra-low load enclosure. The enclosure was designed using current best practices for thermal control and airtightness. The walls and roof assemblies were fully clad



in oriented strand board (OSB) sheathing to support a continuous self-adhered membrane. This membrane was detailed as the air barrier system, which was continuous over the roof/wall interface and integrated with windows and other enclosure penetrations. Insulating sheathing was added over this membrane: 4 in. of polyisocyanurate (PIC) (R-26) for the walls and 6 in. of PIC (R-39) for the roof (i.e., the “exterior” insulating sheathing approach). The final airtightness test result for this assembly was 0.61 ACH50. An extensive set of detail drawings was prepared for this project and construction and quality control processes were documented (Lukachko et al. 2011).

In Wyandotte, 18 houses were constructed using a hybrid insulation approach consisting of 2 in. of extruded polystyrene (XPS) insulating sheathing (R-10), with 2 in. of closed cell spray polyurethane foam (ccSPF) sprayed to the interior of the insulating sheathing (R-12), fiberglass batt insulation was used to fill the balance of the 2 × 6 wood stud cavity (R-12). There were two primary outcomes from this research. First, the airtightness measurements demonstrated that builders having little previous experience with energy-efficient construction techniques were able to achieve consistent results that are < 1.5 ACH50. Second, the process changes implemented to help secure these results were straightforward and ended up encouraging better communication between designer, builder, and the officials supervising the project (Lukachko et al. 2012).

### **1.3 Research Questions**

Researchers and builders have gained experience with the detailing and construction of high R-value wall assemblies. Past work described in the section above has identified the moisture risks for high R-value walls; however, more work is needed to quantify the risk. Furthermore, a number of variables affect the risk (climate, cladding type, insulation type and location, etc.) and more information is needed to assess the impact of each of these. Finally, with the continued introduction of new materials, changing indoor environmental conditions, enhanced expectations from the occupants, and higher performance standards, there are a myriad of factors that need to be considered before moisture guidelines can be developed for high R-value wall assemblies. To further develop our understanding of these factors, the following research questions are addressed in this report.

1. What is the role of insulation levels on the risk in different climates?
2. How resistant are the walls to air leakage and vapor diffusion in different climates?
3. What are the drying rate capacities of the proposed wall assemblies?
4. What are the high-level steps necessary to build moisture-resistant high-R wall assemblies?

To answer these questions, hygrothermal simulations were prepared to assess the performance of representative high R-value walls in a range of climate zones. The study was structured to assess the sensitivity and response to different factors. The simulations were calibrated against field experience with and laboratory research on similar high-R wall assemblies. The approach to this work is described in Section 2 below.

## 2 Modeling Methods

### 2.1 Technical Approach

In this project, hygrothermal modeling tools, field experience, and building science theory were used to address the research questions. These research questions can be divided into two main sections: (1) what are the limits for water vapor diffusion and air leakage in select climates, and (2) what are the moisture performance characteristics of the proposed high-R wall assemblies in a range of climates? Each section is considered separately from a modeling perspective.

To assess the limits of water vapor diffusion and air leakage in wall assemblies, a parametric study was devised. The study compares the response of two wall assemblies, one that is particularly sensitive to moisture loads and another that is more tolerant based on experience, to bound the limits of the problem. These walls were simulated in a range of climates (very cold, cold-humid, hot-humid, and hot-dry) and subjected to differing levels of interior RH and air leakage rates. Certain climate zones required specialized treatment for vapor or thermal control to maintain code compliance. In all cases, the walls were created to comply with the 2012 International Residential Code (IRC).

To assess the moisture performance characteristics of the proposed high-R walls, a comparative modeling approach was used. Select cities, representative of a range of climate zones, were chosen to expose the proposed walls to a range of environmental conditions. A baseline simulation was then conducted to better compare the walls with added moisture loads. The proposed walls were then subjected to a series of moisture loadings from three major sources of moisture: construction moisture, air leakage condensation, and bulk water leakage. The degree of moisture loading was based primarily on experience, but also refers to published literature (i.e., ASHRAE 160P-09) (ASHRAE 2009). The results were recorded and analyzed.

The reader is cautioned that the research contained within this report is based largely on simulations and has not been verified empirically. It is based on assumptions derived from significant field experience and published literature and the results were compared with known performances of high-R buildings. However, to validate the models, empirical research on small- and full-scale assembly mockups and buildings, with monitored boundary conditions and instrumented with temperature and moisture sensors, needs to be undertaken to examine and fully quantify these risks—this will be identified in the conclusions as a future research need.

#### 2.1.1 Selection of High-R Walls

High-R walls, for the purpose of this report, are defined as walls that exhibit an effective R-value greater than double the code required thermal resistance of the wall assembly. In general, they provide an R-value that reaches, at a minimum, the recommended R-value in Table 1. An effective R-value is different than the clear wall R-value, which accounts for only a one-dimensional section through the wall and does not consider the effects of thermal bridging. Consequently, the effective R-value better approximates the actual wall thermal performance by accounting for the effects of thermal bridging through wood studs, plates, joists, and other framing members.

A total of nine walls were considered for this report, of which five derive from the high-R walls report, discussed in greater detail below. It should be noted that some of these walls do not

strictly comply with the high-R definition for cold climates. However, in warmer climates (i.e., climate zones 1 through 3), these would qualify as the effective R-value is greater than double the code requirement.

The five most common, high performance walls were selected based on five criteria: thermal control, durability, buildability, cost, and material use. Table 2, adapted from Straube and Smegal (2009a), shows the performance of the various walls to these selected criteria. The weight for each criterion was set to 1.0 for the purposes of this report. However, depending on the needs of the user, the weights can be modified to more accurately reflect their needs. To do this, a user would apply a weighting of  $> 1.0$  if the criteria was deemed to be more important (e.g., optimized for thermal control) or  $< 1.0$  if the criterion was deemed to be less important (e.g., a custom house might lower the importance of first cost in favor of performance). The other four wall types were not rated in the high-R report and are thus not scored.

**Table 2. Wall Comparison Chart (Straube and Smegal, 2009a)**

	<b>Thermal Control</b>	<b>Durability</b>	<b>Buildability</b>	<b>Cost</b>	<b>Material Use</b>	<b>Total</b>
<b>Criteria Weighting</b>	1	1	1	1	1	
<b>Wall 1: Advance Framed Wall With 4 in. of Exterior Insulating Sheathing</b>	4	4	4	4	4	20
<b>Wall 2: Hybrid Advance Framed Wall With 2 in. of Exterior Insulation, and 2-in. of ccSPF and 3.5 in. of Fiberglass Batt</b>	–	–	–	–	–	–
<b>Wall 3: Advance Framed Wall With 7.25 in. of ccSPF</b>	–	–	–	–	–	–
<b>Wall 4: Double Stud Wall With 9.5 in. of Cellulose</b>	4	3	3	3	2	15
<b>Wall 5: A Hybrid-Insulated Double Stud Wall With 2 in. of ccSPF and Cellulose</b>	5	4	3	3	3	18
<b>Wall 6: Double Stud Wall With 9.5 in. of ocSPF<sup>a</sup></b>	–	–	–	–	–	–
<b>Wall 7: Truss Wall With 9.5 in. of Cellulose</b>	4	3	2	3	3	15
<b>Wall 8: SIPs With 11.5 in. of EPS<sup>b</sup> Insulation</b>	4	4	3	3	3	17
<b>Wall 9: CMU<sup>c</sup> Wall With 2 in. of EIFS<sup>d</sup></b>	–	–	–	–	–	–

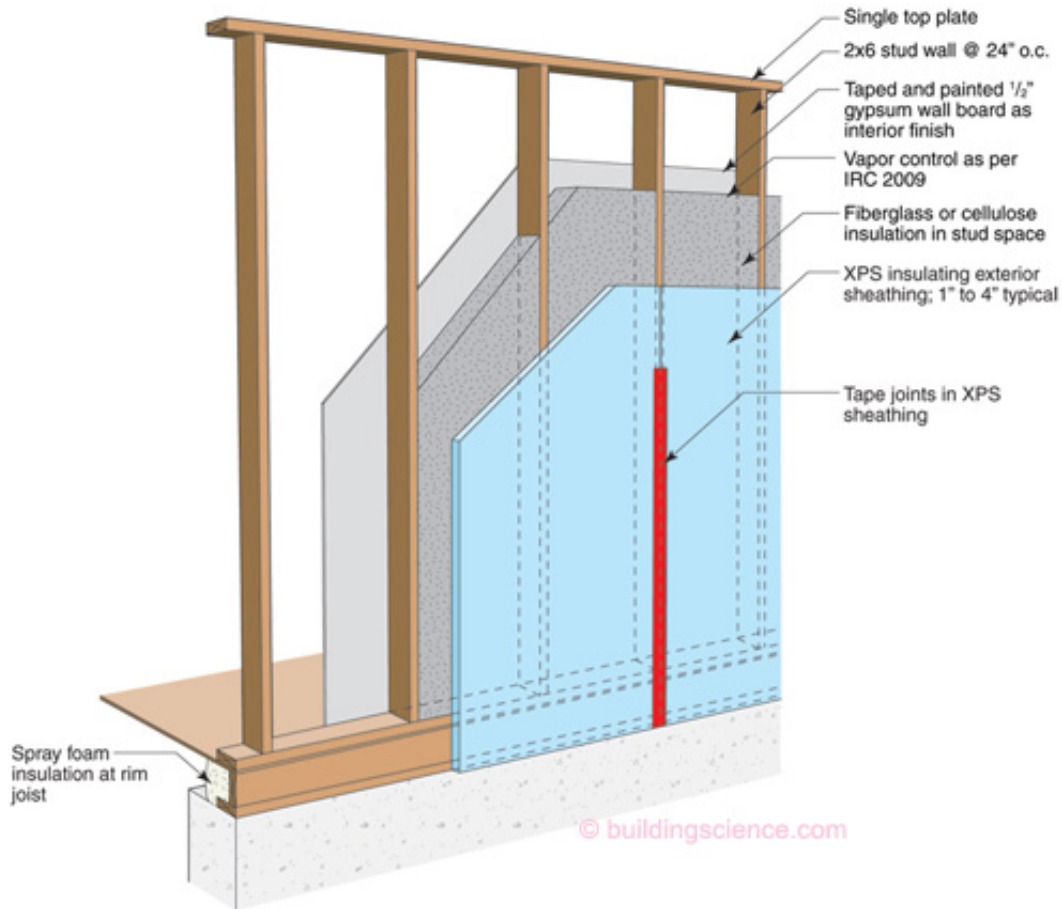
<sup>a</sup> Open cell spray polyurethane foam

<sup>b</sup> Expanded polyurethane

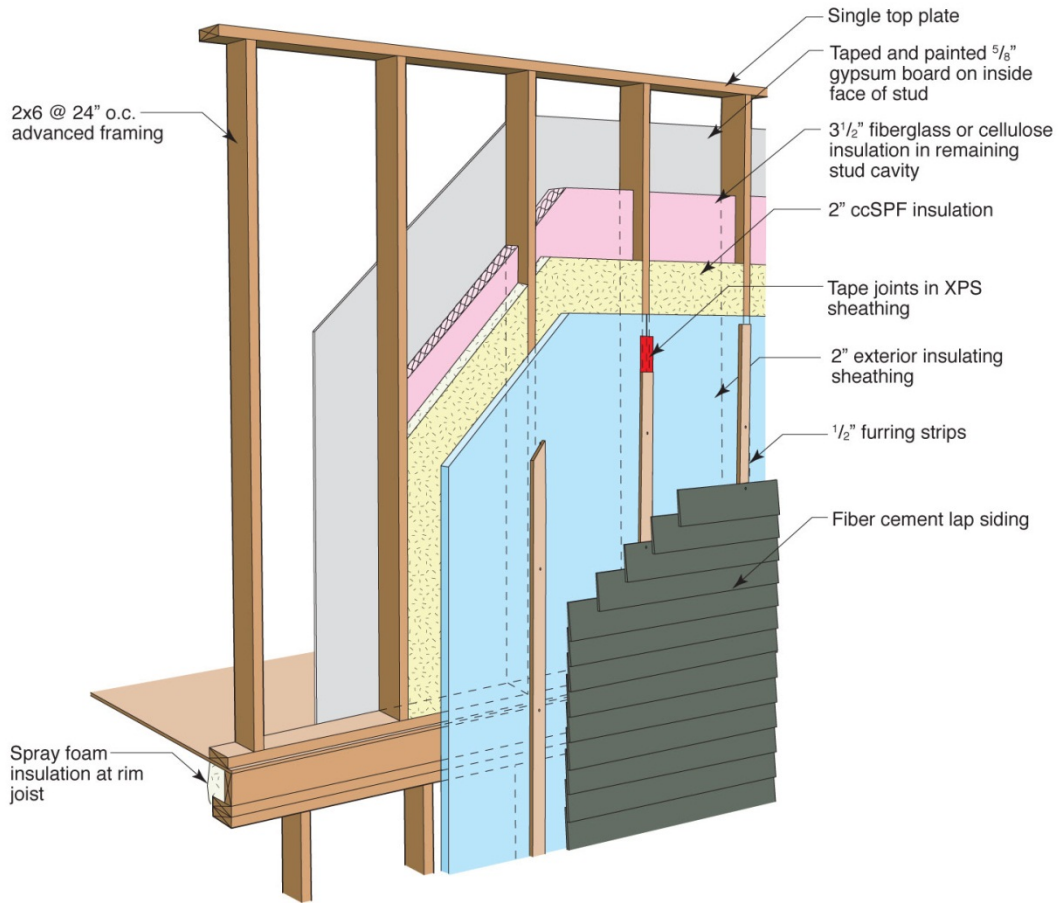
<sup>c</sup> Concrete masonry unit

<sup>d</sup> Exterior insulation finishing system

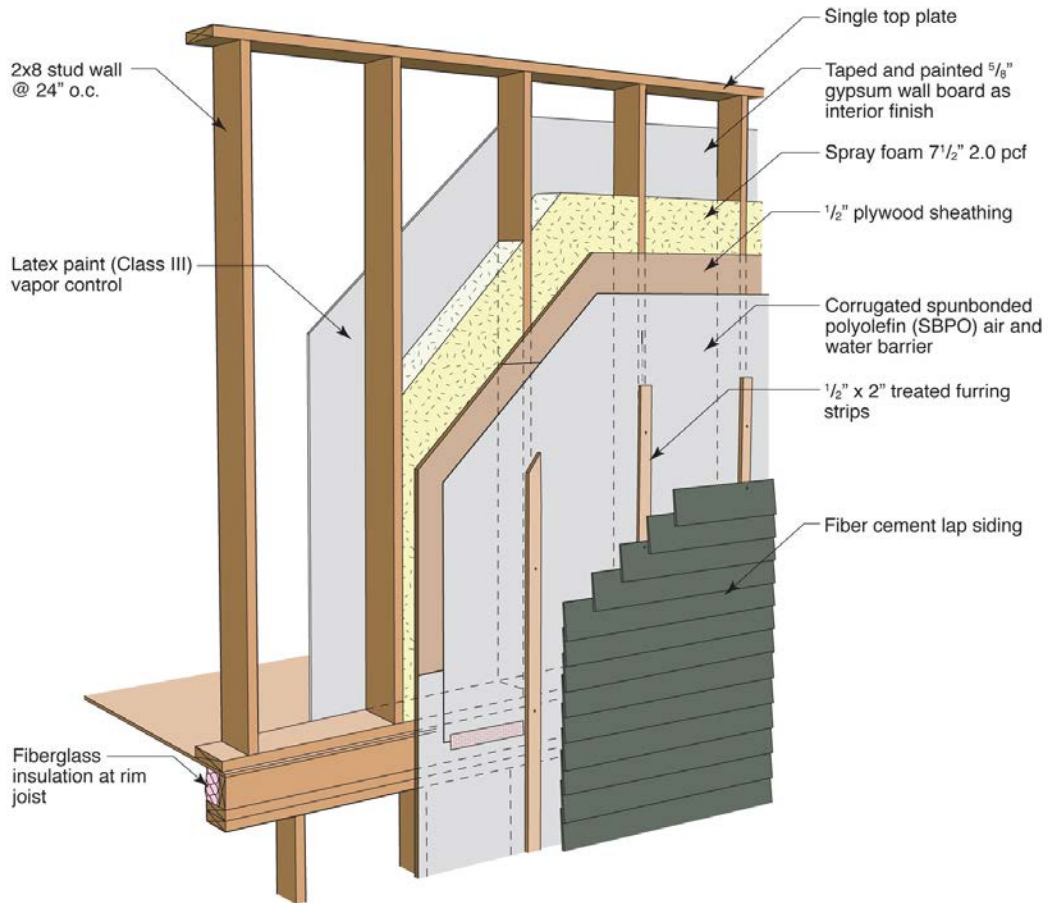
Four main wall types were analyzed in this report: an advance framed wall insulated on the exterior, a double stud wall with different cavity insulations, an SIP wall with 11.5 in. of EPS insulation, and a CMU wall with EIFS insulation. These wall types come in several variations, such as different insulation thicknesses, types of insulation, and the location of vapor and air control layers through the wall assembly. Each section will discuss any wall type variations that were made to ensure superior moisture performance. Sample sectional cutaways of the four wall types may be found below, in Figure 2 to Figure 10.



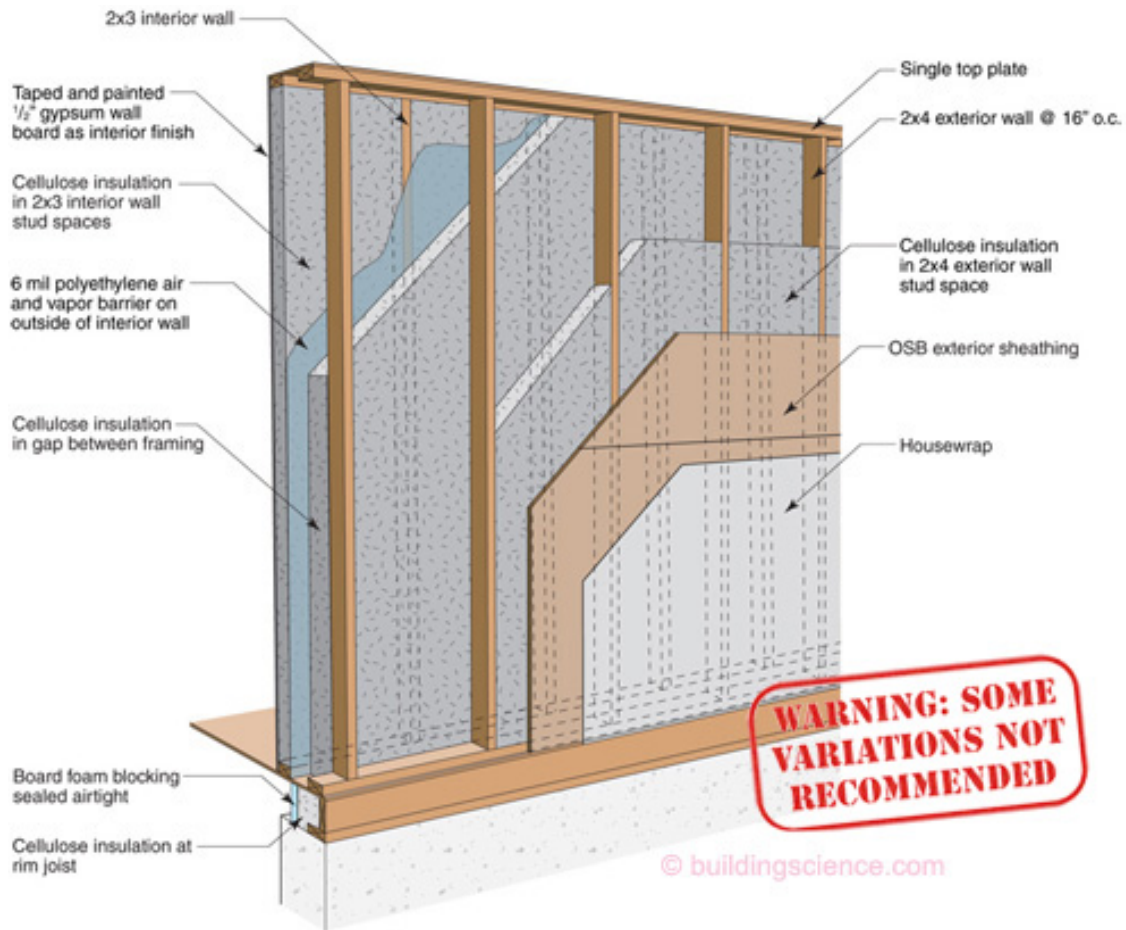
**Figure 2. Wall 1: Exterior insulation on advance framed wall**  
(Straube and Smegal 2009a)



**Figure 3. Wall 2: Exterior insulation on hybrid advance framed wall**  
(Straube and Smegal 2009a)

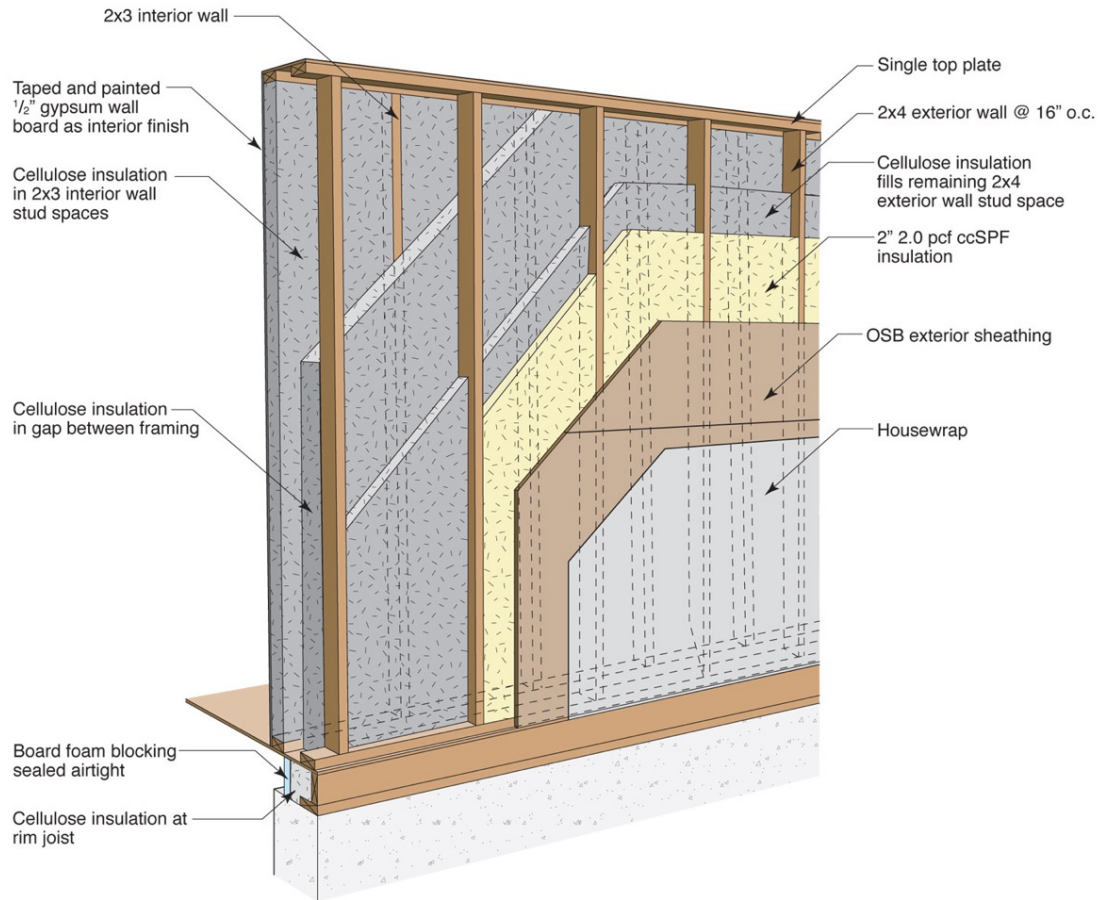


**Figure 4. Wall 3: Advance framed wall with ccSPF cavity insulation**  
(Straube and Smegal 2009a)

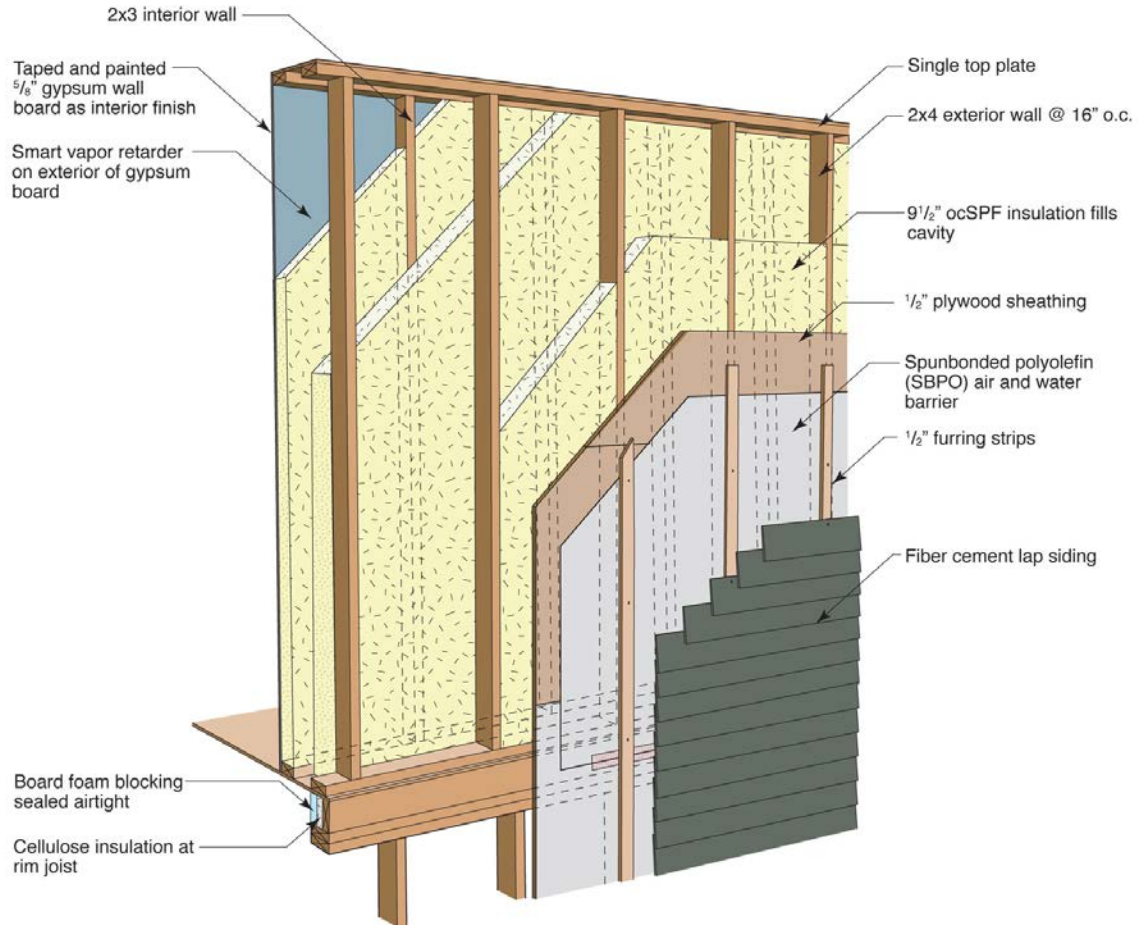


**Figure 5. Wall 4: Double stud wall with fully installed cellulose fiber insulation (CFI)**  
(Straube and Smegal 2009a)

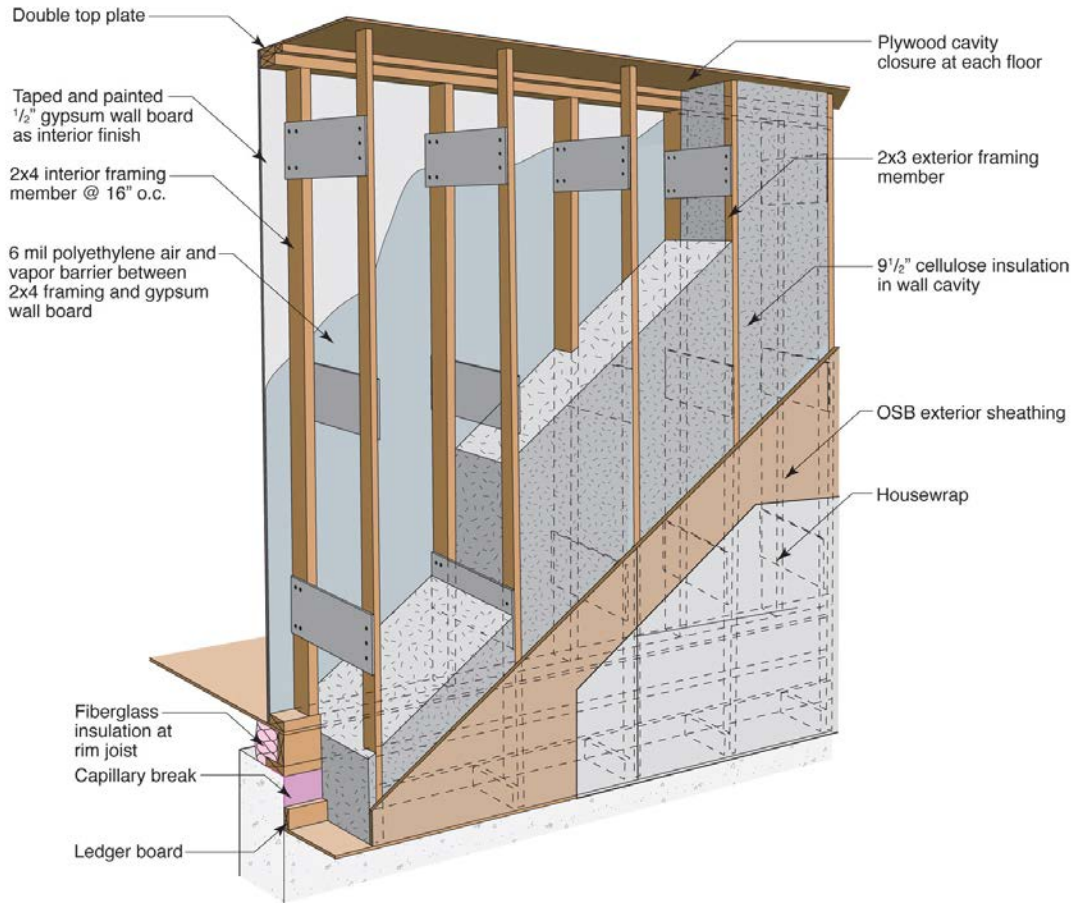




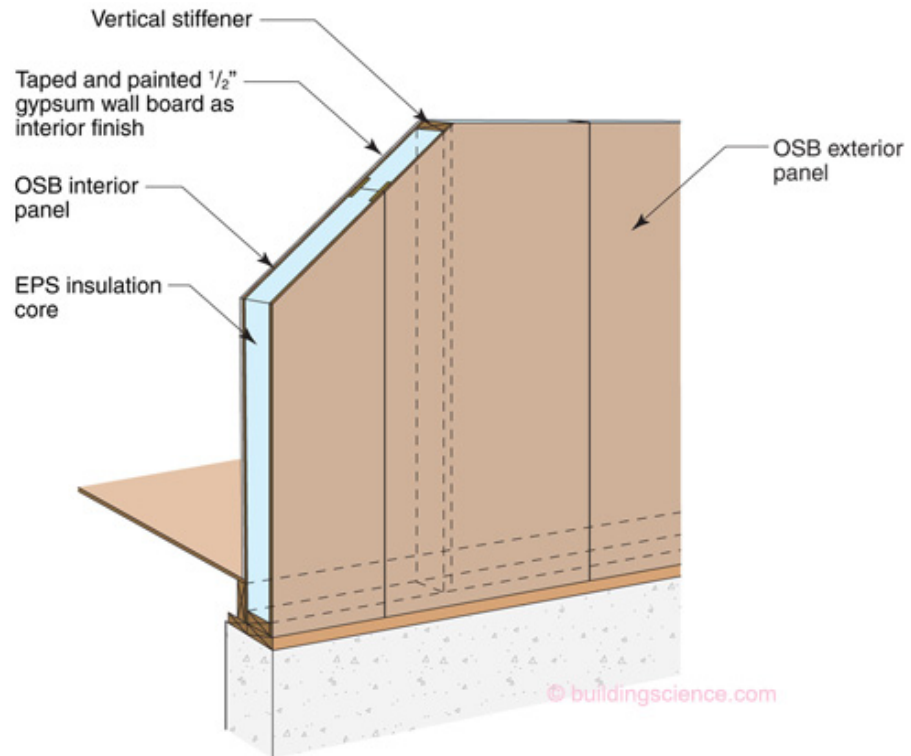
**Figure 6. Wall 5: Hybrid-insulated double stud wall with 2-in. of ccSPF and CFI fill**  
(Straube and Smegal 2009a)



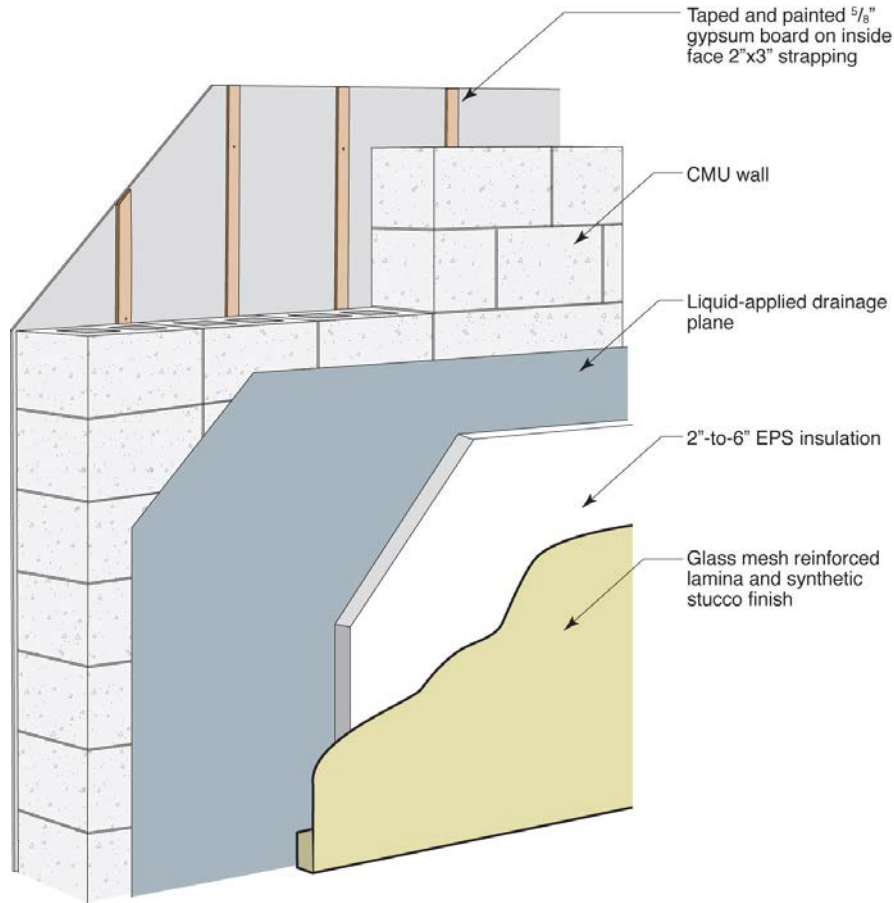
**Figure 7. Wall 6: Double stud wall with 9.5 in. of ocSPF**  
(Straube and Smegal 2009a)



**Figure 8. Wall 7: Truss wall with 9.5 in. of CFI fill**  
(Straube and Smegal 2009a)



**Figure 9. Wall 8: SIP wall**  
(Straube and Smegal 2009a)



**Figure 10. Wall 9: CMU wall with EIFS**

As several of the criteria reference buildability, cost, and material use, extremely high R-value products, such as vacuum insulated panels, or aerogels, were not considered. These materials are considered to be cost prohibitive for most projects, not accessible to typical developers and builders, and beyond the scope of this work. It should be noted that the walls examined in this report will have some similarities with walls constructed with these more expensive materials.

### **2.1.2 Hygrothermal Simulations**

Computer simulations were performed using WUFI Pro 5.1 to evaluate the thermal control and moisture durability (i.e. the hygrothermal performance) of the nine wall assemblies. WUFI Pro 5.1 was developed by the Fraunhofer Institute for Building Physics and Oak Ridge National Laboratory.

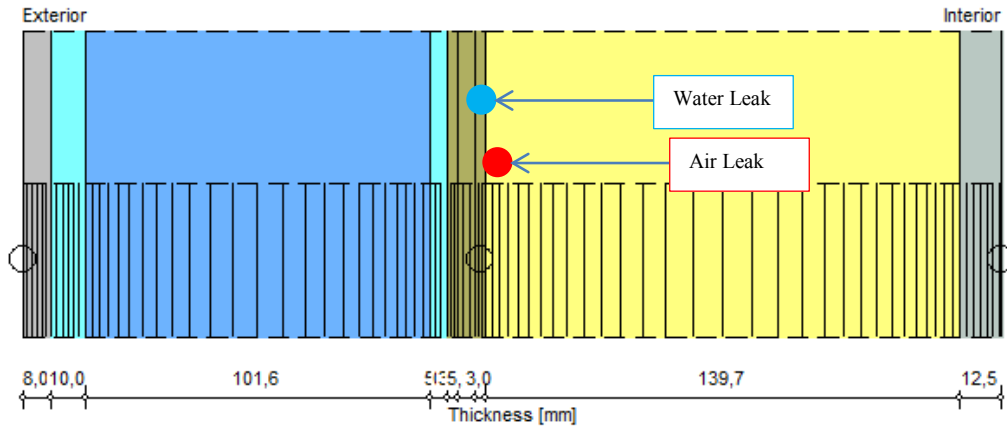
Current moisture flow theory has difficulty in properly accommodating for the inhomogeneity, transient temperature and moisture characteristics, and anisotropic properties of building materials. Some programs attempt to capture fundamental physics at the microscopic level. This approach can lead to highly accurate models for very specific situations; however, the models do not cover an adequate portion of the range of problems encountered in applied building science. Furthermore, such models require a significant number of detailed material properties and

characteristics, and considerable effort and time are required to make the necessary measurements. Frequently, this information is often not available for the materials in question.

WUFI is somewhat unusual in that its underlying equations and algorithms are based upon macroscopic empirical behavior of organic and inorganic materials (Künzel 2002). This precludes the detailed testing required to generate topological material properties (e.g., pore size distribution, frequency of checks and cracks, etc.). The accuracy of the WUFI simulations has been verified by the Fraunhofer Institut für Bauphysik in Holzkirchen, Germany, against numerous full-scale field studies of enclosures over a number of years.











WUFI possesses the capacity to properly account for water vapor adsorption and the absorption and redistribution of liquid water. The simulation is run for a given period, with the most common time step being 1 hour, considering the effects of sun, rain, temperature, and humidity. The quality of the results is extremely dependent on the quality and accuracy of the input material and condition data.

Sample cross-sectional images of the nine proposed high R-value wall types may be found in Figure 11 through Figure 19. Details of the boundary conditions (i.e., surface transfer films, including vapor diffusion resistance of paints), may be found in Section 2.1.4.

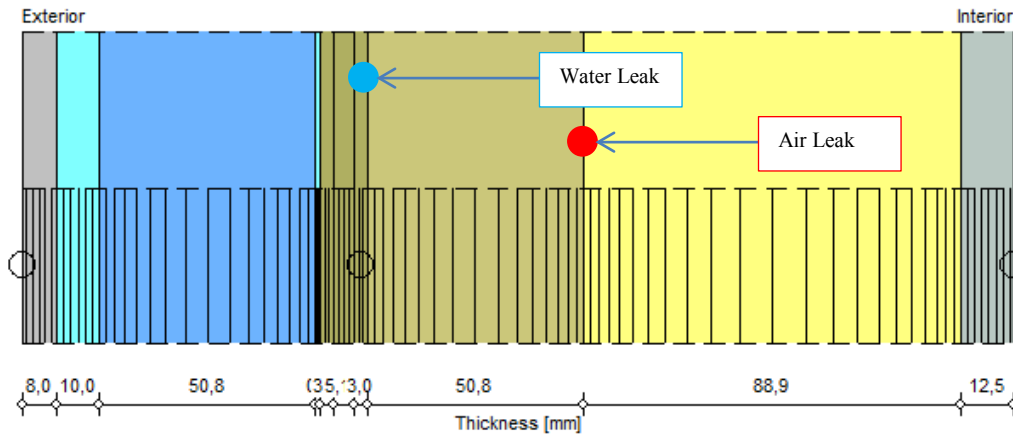


○ - Monitor positions

Materials :


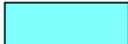



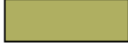
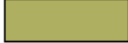




-  - Fibre Cement Sheathing Board
-  - Air Layer 10 mm; without additional moisture capacity
-  - Extruded Polystyrene Insulation R5-inch
-  - 1mm Air-Drainage Gap
-  - Spun Bonded Polyolefine Membrane (SBP)
-  - \*Oriented Strand Board- Outer 3mm
-  - Oriented Strand Board
-  - \*Oriented Strand Board- Inner 3mm
-  - Fibre Glass
-  - Gypsum Board (USA)

**Figure 11. Wall section 1: Advance framed wall with 4 in. of exterior insulation**



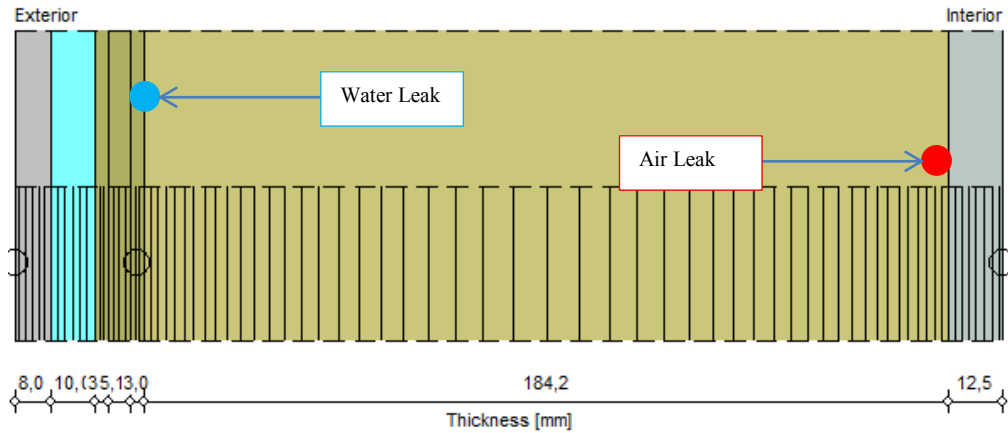
○ - Monitor positions

**Materials :**

-  - Fibre Cement Sheathing Board
-  - Air Layer 10 mm; without additional moisture capacity
-  - Extruded Polystyrene Insulation R5-inch
-  - 1mm Air-Drainage Gap
-  - Spun Bonded Polyolefine Membrane (SBP)
-  - \*Oriented Strand Board- Outer 3mm
-  - Oriented Strand Board
-  - \*Oriented Strand Board- Inner 3mm
-  - Sprayed Polyurethane Foam; closed cell
-  - Fibre Glass
-  - Gypsum Board (USA)

**Figure 12. Wall section 2: Advance framed wall with 2 in. of exterior insulation, 2 in. of ccSPF, and 3.5 in. of batt insulation**





○ - Monitor positions

Materials :









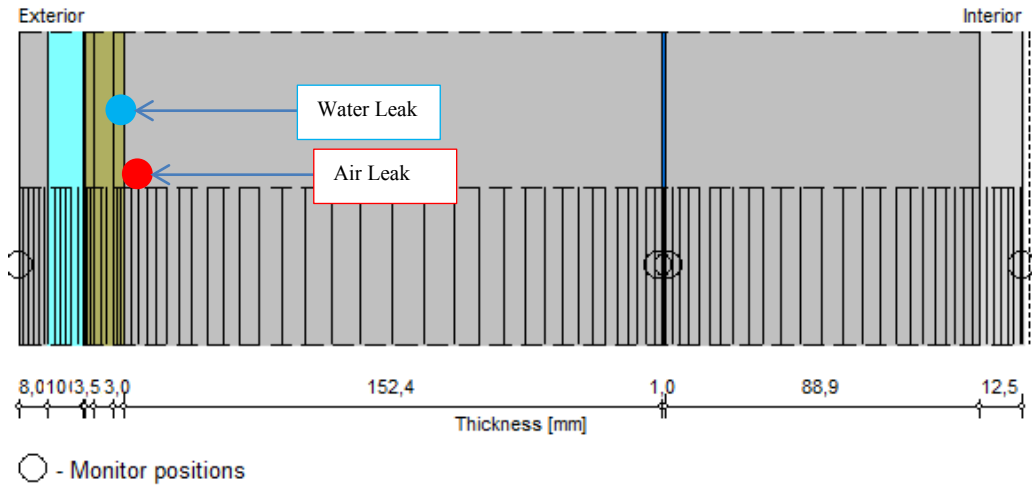
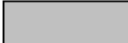









-  - Fibre Cement Sheathing Board
-  - Air Layer 10 mm; without additional moisture capacity
-  - Spun Bonded Polyolefine Membrane (SBP)
-  - \*Oriented Strand Board- Outer 3mm
-  - Oriented Strand Board
-  - \*Oriented Strand Board- Inner 3mm
-  - Sprayed Polyurethane Foam; closed cell
-  - Gypsum Board (USA)

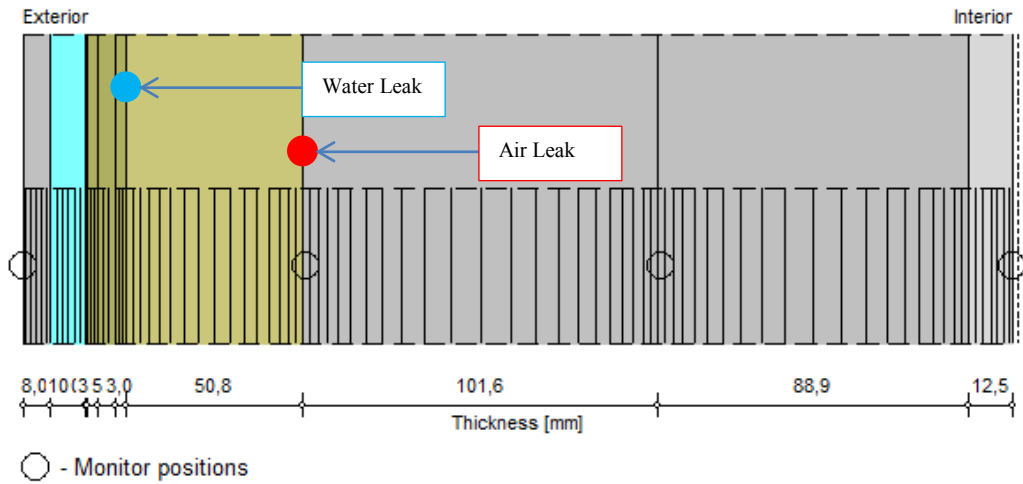
Figure 13. Wall section 3: Advance framed wall with 7.25 in. ccSPF cavity insulation



Materials :

-  - Fibre Cement Sheathing Board
-  - Air Layer 10 mm; without additional moisture capacity
-  - Spun Bonded Polyolefine Membrane (SBP)
-  - \*Oriented Strand Board- 3mm Outer
-  - Oriented Strand Board
-  - \*Oriented Strand Board- 3mm Inner
-  - Cellulose Fibre Insulation
-  - PE-Membrane (Poly; 0.07 perm)
-  - Cellulose Fibre Insulation
-  - Interior Gypsum Board

**Figure 14. Wall section 4: Double stud wall with 9.5 in. of CFI**



Materials :



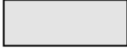







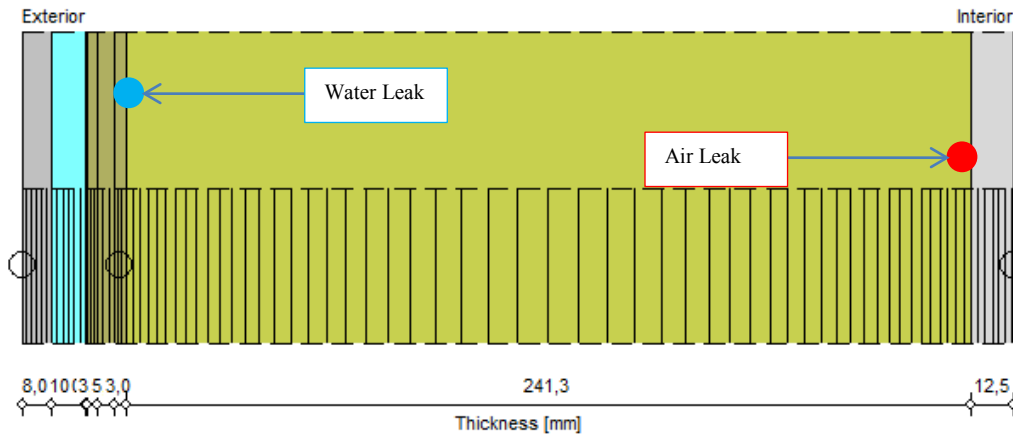
-  - Fibre Cement Sheathing Board
-  - Air Layer 10 mm; without additional moisture capacity
-  - Spun Bonded Polyolefine Membrane (SBP)
-  - \*Oriented Strand Board- 3mm Outer
-  - Oriented Strand Board
-  - \*Oriented Strand Board- 3mm Inner
-  - Sprayed Polyurethane Foam; closed cell
-  - Cellulose Fibre Insulation
-  - Cellulose Fibre Insulation
-  - Interior Gypsum Board

Figure 15. Wall section 5: Double stud wall with 2 in. of ccSPF and 7.5 in. of CFI



○ - Monitor positions

Materials :


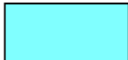






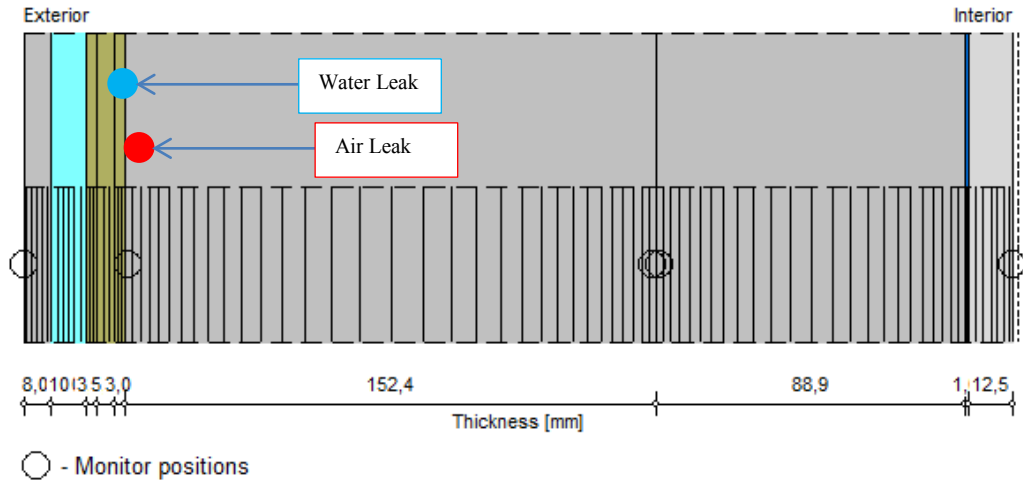

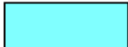








-  - Fibre Cement Sheathing Board
-  - Air Layer 10 mm; without additional moisture capacity
-  - Spun Bonded Polyolefine Membrane (SBP)
-  - \*Oriented Strand Board- 3mm Outer
-  - Oriented Strand Board
-  - \*Oriented Strand Board- 3mm Inner
-  - Sprayed Polyurethane Foam; open cell
-  - Interior Gypsum Board

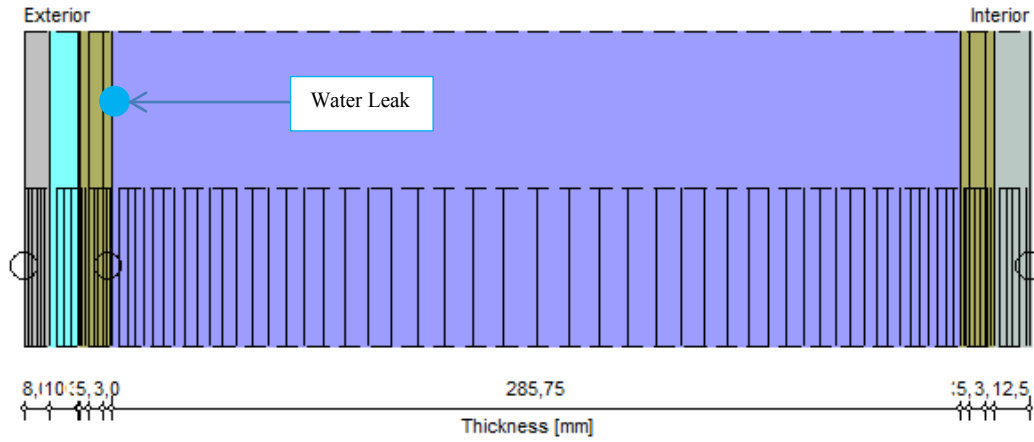
Figure 16. Wall section 6: Double stud wall with 9.5 in. of ocSPF



Materials :












-  - Fibre Cement Sheathing Board
-  - Air Layer 10 mm; without additional moisture capacity
-  - Spun Bonded Polyolefine Membrane (SBP)
-  - \*Oriented Strand Board- 3mm Outer
-  - Oriented Strand Board
-  - \*Oriented Strand Board- 3mm Inner
-  - Cellulose Fibre Insulation
-  - Cellulose Fibre Insulation
-  - PE-Membrane (Poly; 0.07 perm)
-  - Interior Gypsum Board

**Figure 17. Wall section 7: Truss wall with 9.5 in. of CFI**

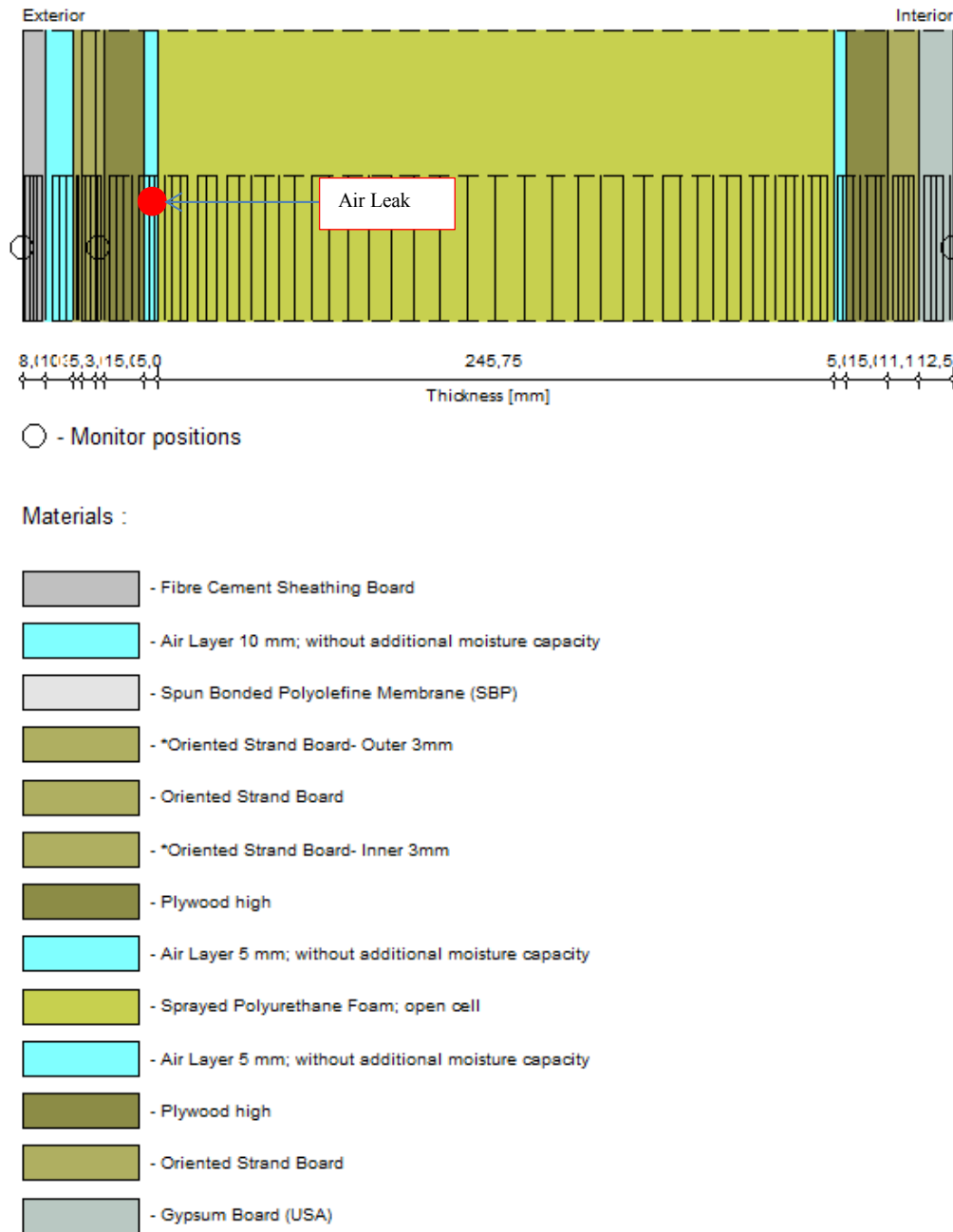


○ - Monitor positions

Materials :

-  - Fibre Cement Sheathing Board
-  - Air Layer 10 mm; without additional moisture capacity
-  - Spun Bonded Polyolefine Membrane (SBP)
-  - \*Oriented Strand Board- Outer 3mm
-  - Oriented Strand Board
-  - \*Oriented Strand Board- Inner 3mm
-  - Expanded Polystyrene Insulation
-  - \*Oriented Strand Board- Inside- Outer 3mm
-  - Oriented Strand Board
-  - \*Oriented Strand Board- Inside Inner 3mm
-  - Gypsum Board (USA)

**Figure 18. Wall section 8a: SIP wall with 11.25 in. of EPS**



**Figure 19. Wall section 8b: SIP joint**

Some parts of the wall construction are highly three-dimensional and, as a result, some aspects of hygrothermal performance can be difficult to model using a one-dimensional hygrothermal simulation tool. The modeling of air leakage is one such example. In a SIP wall, the air leakage will only occur around the joints. Hence, the wall section used for air leakage condensation in the SIP is based around the joint between these two panels. Other issues include correctly identifying the amount of moisture deposited by air leakage or through bulk water leakage. The values used in the simulations are based on estimates.

### 2.1.3 Metrics for Analysis

There are no clear models for assessing the moisture durability of building materials. The moisture content to decay mechanism response is not well categorized and defined. Further, a range of decay mechanisms may occur. Table 3 summarizes the types of organisms, the damage type, the requirements for humidity or moisture, and the range of temperature over which these organisms act.

**Table 3. Biodegradative Organisms and Mechanisms**

(Viitanen and Salonvaara, 2001; Viitanen et al, 2003)

Type of Organism	Damage/Problem Type	Humidity or Moisture Range (RH or MC%)	Temperature Range (°F [°C])
<b>Bacteria</b>	Biocorrosion of many different materials, smell, and health problems	Wet materials RH > 97%	~23–140 (–5 to +60)
<b>Mold Fungi</b>	Surface growth on different materials, smell and health problems	Ambient RH > 75%, Depends on duration, temperature, and mold species	~ 0–122 (0 to +50)
<b>Blue-Stain Fungi</b>	Blue-stain of wood and permeability change of wood	Wood MC > 25%–0% RH > 95%	~ 23–113 (–5 to +45)
<b>Decay Fungi</b>	Different types of decay in wood (soft rot, brown rot, or white rot), also many other materials can be deteriorated. Strength loss of material.	Ambient RH > 95%, MC > 25%–120% depends on duration, temperature, fungus species, and materials	~ 32–113 (0 to +45)
<b>Algae and Lichen</b>	Surface growth of different materials on outside or weathered material	Wet materials, also nitrogen and low pH are required	~ 32–113 (0 to +45)
<b>Insects</b>	Different type of damage in organic materials, surface failures or strength loss	Ambient RH > 65%, depends on duration, temperature, species, and environment	~ 41–122 (5 to +50)

Due to high-level media attention from sick building syndrome and black mold, molds are frequently the primary concern of moisture durability for occupants. The difficulty with assessing moisture risk from mold sources is a range of factors that fundamentally affect the predisposition for its life cycle. These factors include the temperature and water activity (RH or MC) of the substrate, the presence and types of mold spores, the substrate quality (nutritional content, pH value, presence of biocides), and the duration and history of all the above factors.

Molds are either allergenic (i.e., causing allergic reactions in the occupants from mold spores), or toxigenic (i.e., toxic substances created by the metabolic activity of the mold) (Sedlbauer 2004). In general, toxigenic molds, such as *Stachybotrys chartarum* (i.e., black mold), require elevated MCs (i.e., in excess of 95% RH) just to start germination, much less growth (Ayerst 1968).



Allergenic molds, on the other hand, are capable of starting germination at much lower RHs (i.e., 70%–80%), although time to onset of germination and growth is frequently in excess of 21–36 weeks under ideal conditions (Wang and Morris 2012).

Many models exist to try to quantify moisture durability risk, such as those by Sedlbauer (biohygrothermal method, or WUFI BIO), Viitanen (the VTT biodeterioration model), the Institute for Research in Construction- National Research Council of Canada (the RHT index), and the ASHRAE 160 criterion; however, each is limited by its fundamental assumptions. Currently, none of the models are able to categorically account for transient or seasonal fluctuations to the fundamental properties required for mold growth. Further, extreme conditions may negatively affect mold health, either causing cessation of growth, recession, or even death of the fungi.

It has been shown that short periods of time at high humidity conditions will not lead to fungal growth if the periods at low humidity preventing mold growths are sufficiently long (Viitanen and Bjurman 1995). If the period of high RH is longer than 24 hours, the cumulative effect of mold growth is more pronounced. However, a very low or negligible growth response is expected if the dry periods between wetting events are prolonged (Viitanen and Bjurman 1995).

Due to the limitations of the models, a simpler and more transparent approach is used. To compare the moisture durability of the wall assemblies, the MC of a thin slice ( $\frac{1}{8}$  in. [3 mm]) of the structural sheathing on the interior and exterior faces is obtained from the simulations on an hourly basis. OSB sheathing moisture is used as the performance criteria because this is generally where moisture will accumulate and the wood sheathing is a moisture-susceptible material. The peak daily OSB sheathing MC was determined and the risk was assessed based on the following criteria:

- Peak OSB sheathing MC < 20%, no mold growth; very little risk
- Peak OSB sheathing MC 20%–28%; potential for mold growth eventually, depending on frequency and length of wetting, and temperatures during wetting. This design can be successful, but conservative durability assessments usually require corrective action
- Peak OSB sheathing MC > 28%; moisture-related problems are expected and this design is not recommended.

A thin slice moderates the surface MC such that the averaging function of the software does not artificially reduce the actual MC with the drier core. The MC and temperature are recorded and analyzed.

Predicted wood MCs of OSB are generally assessed with respect to relative risk as opposed to being judged on a pass/fail criterion. The predicted MC should be kept in context and good engineering judgment is required to determine the moisture risk to the sheathing. For example, elevated wood MCs in the cold winter months when the wood substrate is on the cold side of the assembly are much safer, from a mold growth perspective, than similar MCs in the summer, when mold will grow more quickly.

### 2.1.4 Climates, Locations, and Boundary Conditions

Different climate zones present a range of exterior conditions that can greatly affect the wall assembly. To encompass the range of environmental conditions that buildings may experience throughout the United States, select cities, representing a range of climate zones, as seen in Table 4, were selected. The cities were selected based on a combination of city and population size, climate, and availability of climate data. The embedded weather files in WUFI were used for this modeling and, as a result, the climate data do not include extreme values usually associated with major disasters such as hurricanes or 1/100-year temperatures.

**Table 4. Simulated Cities and Heating Degree Day and Cooling Degree Day Data**  
(ASHRAE 2009)

City	Climate Zone	Description	Heating Degree Day 65°F (18.3°C)	Cooling Degree Day 65°F (18.3°C)	Coldest 3-Month Average Temperature °F (°C)
International Falls	7	Very cold, dry	10,487 (5826)	248 (138)	1.0 (-17.2)
Chicago	5A	Cold, moist	6,311 (3506)	842 (468)	20.3 (-6.5)
St. Louis	4	Temperate	4,504 (2502)	1,631 (906)	23.9 (-4.5)
Seattle	4C	Maritime Temperate	4,729 (2627)	1,76 (98)	39.7 (4.3)
Atlanta	3	Temperate	2,990 (1661)	1,667 (926)	38.7 (3.7)
Houston	2	Hot, moist, coastal	130 (72)	4,459 (2477)	65.7 (18.7)

The interior temperature and RH utilized in the modeling are also included in Table 5. The temperature and RH vary sinusoidally, according to the peak values for the summer and winter seasons, as seen in Table 5. These values were selected based on BSC experience and recorded data.

**Table 5. Summer and Winter Indoor Conditions**

City	Summer Conditions		Winter Conditions	
	Temperature °F (°C)	RH (%)	Temperature °F (°C)	RH (%)
International Falls	70 (22)	60	68 (20)	30
Chicago	70 (22)	60	68 (20)	40
St. Louis	70 (22)	60	68 (20)	50
Seattle	70 (22)	60	68 (20)	60
Atlanta	70 (22)	60	68(20)	55
Houston	70 (22)	60	68 (20)	60

In this project higher indoor RHs are utilized to establish an anticipated “average upper limit” to what a high performance, airtight building would likely experience. Should the walls be able to accommodate such high moisture loading, the building enclosure will be able to safely handle

any indoor RH below the designated RH. The analysis therefore should result in moisture-tolerant high-R walls.

The boundary conditions were identical for each of the wall assemblies studied (see Table 6).

**Table 6. Boundary Conditions**

Model Properties	Value
Heat Resistance	0.33 (ft <sup>2</sup> ·°F·h/Btu)
Sd-Value	None
Short-Wave Radiation Absorptivity	0.8
Long-Wave Radiation Emissivity	0.9
Effective Adhering Rain-Fraction	0.45
Interior Heat Resistance	0.71 (ft <sup>2</sup> ·°F·h/Btu)
Interior Sd-Value	1 (ft)
Vapor Permeance of the WRB	52 (U.S. perms)

The boundary condition values were selected based on standard published values (Straube and Burnett 2005). The interior Sd-value, or a linear vapor diffusion resistance factor, is equivalent to two layers of latex paint over a primer. Additional material properties used in the hygrothermal models may be found in Appendix B.

### 2.1.5 Building Enclosure Selection

A brief parametric study was undertaken to assess the effects of the cladding and ventilation rates of the drainage space. Water storing claddings place wall assemblies at greater risk, due to increase flows of moisture due to elevated vapor pressures. Similarly, very low or high ventilation rates of the drainage space immediately behind the cladding will mediate the amount of moisture to which the walls are exposed. All wall assemblies were assumed to use a spun-bonded polyolefin water resistive barrier (WRB), due to the pervasiveness of its use within the residential building industry. This WRB typically possess very high vapor permeance values, which enable outward drying, but may also result in large inward vapor flows. Interior vapor controls were not directly investigated, as these fall under the purview of the vapor diffusion and air leakage limits analysis.

For the purposes of the report, all wall assemblies used a fiber cement cladding, with ACH20 air space ventilation in a ½-in. air gap. The results of these simulations should not be extended to moisture storing claddings (i.e., brick or direct applied stucco), as these cladding types created a significant moisture load on the wall assembly.

### 2.1.6 Simulation of Moisture Loads

Four sets of hygrothermal simulations were prepared to assess the moisture risk associated with each wall assembly. The four simulation sets are discussed in Sections 2.1.6.1 to 2.1.6.4.

#### 2.1.6.1 Base-Case Simulations

To determine optimal approaches to moisture management, first a base case model must be established. The base case comprises the wall to be tested with no additional modifications or moisture loads, aside from the established boundary conditions.

### 2.1.6.2 Simulated Construction Moisture

Construction moisture is another source of moisture that can pose moisture problems to the building enclosure. Enclosures that are vapor tight may sometimes retain and hold moisture for prolonged periods of time. Usually, the moisture diffuses out of the wall over time, but certain wall assemblies dry out very slowly. The wood components of the wall assembly start the simulation at the fiber saturation point (28% MC) (FPL 1999). The drying starts on October 1. This creates a worst-case scenario, as the MC in wall assemblies starts to increase in the autumn and is unable to dry out until spring. If the walls are unable to reach an MC < 20% after several months, there is a good probability that mold growth would occur (FPL 1999; Sedlbauer 2004).

### 2.1.6.3 Interior Air Leak

Interior air leaks can pose a serious problem to highly insulated walls. The use of thick layers of insulation, frequently with low vapor permeance, cannot only result in colder interstitial temperatures, but may also inhibit drying.

A simulated air leak was modeled in all the proposed wall assemblies. The rate of the air leak was first obtained by collecting a range of air changes per hour from blower door tests of high performance homes. Three air leakage rates were selected to depict three levels of common performance: 0.5 ACH50, 1.5 ACH50, and 2.5 ACH50. These represent a range of air leakage rates for air tight, high performance homes. Based on the 2010 U.S. Census, the average home size was 2,392 ft<sup>2</sup>. Dickerhoff et al. (1982) and Harrje (1982) have shown that approximately 35% of all residential building air leakage occurs through the wall. By factoring the amount of wall component of the building air leakage, and assuming a surface area for the average home size (approximately 4,000 ft<sup>2</sup>), an air leakage rate per unit area at 50 Pascals of pressure of wall was obtained. To reduce air leakage at the standardized test pressure (50 Pa) down to natural levels (typically assumed to be 4 Pa), the Sherman-Grimsrud method was used (Sherman and Grimsrud 1980), utilizing standard coefficients. The results are summarized in Table 7.

**Table 7. Air Leakage Rate Conversions: Whole Building Surface Area Values**

<b>Air Leakage Rate Results</b>	<b>Air Leakage Rate (cfm·ft<sup>-2</sup> @ 50 Pa)</b>	<b>Air Leakage Rate (cfm·ft<sup>-2</sup> @ 4 Pa)</b>
<b>0.5 ACH50</b>	0.041	0.008
<b>1.5 ACH50</b>	0.123	0.024
<b>2.5 ACH50</b>	0.205	0.040

These air leakages rates were used to bound the problem of air leakage limits for high-R, high performance walls. With regards to the wall comparisons, the upper air leakage rate (i.e., 2.5 ACH50) was used to demonstrate the intrinsic resistance each wall possesses to incident air leakage.

To simulate an air leak in WUFI, first, a small air layer must be created within the model. The location of this layer can significantly affect the results of the simulation, and thus experience in identification of air leakage paths through the wall assembly is required. Typically, the air leakage layer was located at the first upstream condensing plane with regards to the direction of the airflow, whether the air is exfiltrating or infiltrating. In cold climates, exfiltration is the primary concern with regards to air leakage condensation. Warm and humid interior air can leak through the wall assembly and upon contacting cold interstitial surfaces, condensation of the

water vapor can occur. Contrarily, infiltration poses the greatest risk in hot climates, as moist exterior air can contact the cold surface of the gypsum wall board (GWB) in air-conditioned buildings—although the temperature differences over the assembly are typically much less than in cold climates. The air leakage layer was also created sufficiently small that it would not noticeably affect the effective R-value of the assembly. The unit area air leakage rate at natural pressures was converted into an equivalent air leakage rate that could be computed by the program. The MCs of the OSB sheathing in each simulation were collected and analyzed.

#### *2.1.6.4 Simulated Bulk Water Penetration*

A serious source of moisture is leaks caused by wall penetrations, such as windows, doors, and other utilities. To simulate a window leak, 2% of the wind-driven rain was assumed to bypass the wall assembly and deposit itself on to the inside surface of the OSB sheathing. This simulates rain striking the window and draining down into a small hole into the frame. While ASHRAE 160 recommends using 1% of the wind-driven rain to represent a leak, the impermeability of a window increases the effective catchment area. Unfortunately, little research is available to quantify the amount or rates of water penetration in various types of leaks (roof, window, mechanical penetration, etc.).

A brief sensitivity analysis was conducted to compare the results of 1%, 2%, and 5% leaks. The results suggest that a 1% leak is insufficient to create the severe and localized damage that is observed in forensic investigations. However, at leakage rates of 2% or more, it was found that the MCs are appreciably high to recreate the observed levels of biodeterioration. Further, a value of 2% has been used by others (Kramer and Karagiozis 2004). However, after letting the simulations reach hygric equilibrium at a 2% leak (i.e., from reaching hygric equilibrium for the entire wall assembly), it was found that it closely approximated the results of using a 5% leak for a much shorter simulation interval. To reduce computation requirements, a 5% leak was used.

Should elevated moisture levels be present for a long period of time, it is possible that molds may establish themselves into the material. Thereafter, every wetting will provide additional moisture for mold growth. Consequently, the drying rate of the walls is important to ensuring safe functionality of the building enclosure.

### 3 Results and Discussion

In analyzing the results of the simulations, it was found that walls were subject to a much lower moisture risk in warmer climates (i.e., zones 1–3) than in colder climates (i.e., zones 4–8). For warmer climates, the predicted drying rates for construction moisture were measured in weeks, as opposed to months, and air leakage was not predicted to result in moisture problems in any of the walls, either in exfiltration or infiltration, provided that no Class I or II interior vapor barriers are present. In general, warmer climates allow for greater drying potentials in wall assemblies and hence, the assemblies are more likely to be able to manage adverse moisture loadings. The results are divided in to two sections, the first treating the limits of vapor diffusion and air leakage in two wall types in select climates, and the second dealing with the moisture performance of all the proposed high-R walls to different moisture loads in a range of climates.

#### 3.1 Limits of Vapor Diffusion and Air Leakage

To assess the limits of vapor diffusion and air leakage in wall assemblies, two wall assemblies, from the list of high-R walls considered in this report, were selected to present moisture-sensitive and moisture-tolerant wall assemblies. This comparison is useful to bound the limits of possible MCs that may be experienced under the parameters of the simulations. The two walls selected are exemplary of the two main insulation strategies—exterior insulation versus cavity insulation. The moisture-tolerant wall selected was Wall 1: Advance Framed Wall with 4-in. of Exterior Insulation and 5.5 in. of Batt. The moisture-sensitive wall was Wall 4: Double Stud Wall with 9.5 in. of CFI.

Wall 1 was selected due to the elevated substrate temperature provided by the exterior insulation. Further, due to a lack of Class I or II interior vapor retarders, this wall possesses the capacity to dry to the interior. Wall 2 was selected because the OSB sheathing was subjected to near-outdoor temperatures (more extreme temperature variations), and the wall possesses significant moisture storage. Once the wall reaches hygric equilibrium (i.e., is charged and reaches equilibrium with the ambient humidity), a small change in environmental conditions can rapidly create situations that place the moisture-sensitive materials at risk.

The walls were simulated in two cold climates: climate zone 5 (Chicago) and climate zone 7 (International Falls); and two hot climates: climate zone 2C (Houston) and climate zone 2 (Phoenix). The walls were simulated over a range of interior RHs (20%–40%), and from 0– 2.5 ACH50. With regards to air leakage, the critical air leakage path was identified and the air leak was inserted adjacent to the condensation plane. In cold climates, exfiltration indoor air can result in condensation on cold components of the wall assembly, and so the condensation plane is typically the interior side of the OSB sheathing. However, the reverse occurs in hot and humid climates. Warm outdoor air, infiltrating into the wall assembly, can collect behind interior vapor barriers and moisture may condense. The critical condensation plane in warm climates is on the exterior side of the GWB. Table 8 and Table 9 show the peak daily sheathing MCs in cold, very cold, hot-humid, and hot-dry climate zones, with Class I and III interior vapor retarders, for both wall assemblies. The cells highlighted in red show MCs in excess of 28% MC. Cells with a “D” indicate that the worst-case scenario was modeled and the MC of the sheathing remained within safe limits. The “W” indicates that the best-case scenario was modeled and the MC was also dangerously high.

**Table 8. Peak Daily MCs for Exterior Insulated Wall Assembly, With Class I and III Vapor Barriers**

Interior RH	ACH	Chicago		International Falls		Houston		Phoenix	
		1	3	1	3	1	3	1	3
20%	0	10.8	8.9	10.5	13.7	47.8	D	D	D
	0.5	8.5	8.9	10.9	13.6	40.1	D	D	D
	1.5	8.4	8.6	12.0	13.3	50.5	D	D	D
	2.5	12.6	8.5	12.2	13.0	56.8	D	D	D
30%	0	11.1	10.6	10.8	21.3	W	D	D	D
	0.5	9.2	10.8	13.3	23.0	W	D	D	D
	1.5	9.7	10.5	15.9	21.2	W	D	D	D
	2.5	9.7	10.2	16.0	18.0	W	D	D	D
40%	0	11.3	14.4	11.1	36.8	W	D	D	D
	0.5	11.1	14.5	16.2	W	W	D	D	D
	1.5	12.5	14.1	27.1	W	W	D	D	D
	2.5	12.6	13.5	W	W	W	14	8.4	8.4

**Table 9. Peak Daily MCs for Cavity Insulated Wall Assembly, With Class I and III Vapor Barriers**

Interior RH	ACH	Chicago		International Falls		Houston		Phoenix	
		1	3	1	3	1	3	1	3
20%	0	15.3	16.0	15.4	N/A	28.5	D	D	D
	0.5	15.4	19.0	23.5	N/A	30.1	D	D	D
	1.5	17.6	20.8	W	N/A	W	D	D	D
	2.5	19.6	22.1	W	N/A	W	D	D	D
30%	0	15.3	18.6	15.4	N/A	W	D	D	D
	0.5	18.0	24.5	W	N/A	W	D	D	D
	1.5	23.0	23.8	W	N/A	W	D	D	D
	2.5	29.3	28.6	W	N/A	W	D	D	D
40%	0	15.4	22.1	15.4	N/A	W	D	D	D
	0.5	19.7	29.7	W	N/A	W	D	D	D
	1.5	30.1	33.5	W	N/A	W	D	D	D
	2.5	32.8	W	W	N/A	W	14.8	8.4	8.4

Notes:

W indicates that the simulation experienced a convergence failure due to extremely high moisture fluxes, or that the best-case scenario resulted in dangerously high MCs.

D indicates that the worst-case simulations resulted in MCs that do not pose a risk to the wall assembly, and so all the other simulations would result in similar, if not improved, moisture performances.

N/A indicates that this assembly is not code compliant.

### 3.2 Indoor Relative Humidity and Air Leakage

In cold climates, wall components may fall below the critical indoor air temperature for condensation, either from vapor diffusion or air leakage. The colder the climate, the colder the wall components and thus, the more sensitive the assembly becomes to outward flowing

moisture. Exterior insulated wall assemblies possess increased tolerance to elevated indoor RHs since the exterior insulation raises the temperatures of the moisture-sensitive wall components. It is only at extreme interior RHs (i.e., 40% in International Falls), during very cold exterior temperatures that the limits of an exterior insulated wall are reached. On the other hand, cavity insulated walls are much more sensitive to interior RHs, since some of the moisture-sensitive components approach outdoor temperatures, which likely fall below the interior dew point. Under idealized conditions (i.e., with no air leakage), these wall assemblies with Class I vapor retarders perform adequately. However, real wall assemblies all experience some level of air leakage.

A stark contrast in performance can be seen by how the exterior insulated walls outperform the cavity insulated walls when air leakage is considered. Under idealized circumstances, both walls perform adequately in all indoor RHs. However, as soon as a nominal level of air leakage is introduced, the cavity-only insulated walls reached dangerously high MCs, even at 20% indoor RH in climate zone 7. This highlights the importance of considering air leakage in all hygrothermal simulations. Failure to do so may result in false predictions from practitioners unaware of the significance of air leakage effects on the wall's moisture durability.

### **3.3 Interior Vapor Barriers**

This series of simulations show the effects of interior vapor control layers on the moisture performance of the wall assembly. In the exterior insulated wall, the use of a Class I interior vapor retarder in cold climates does not naturally create dangerous conditions for biodegradation unless a bulk water leak occurs. Similarly, a Class I interior vapor retarder in cavity insulated assemblies creates an artificial result, suggesting that the assembly performs adequately, when in reality, when air leakage is considered, dangerously high MCs are predicted.

In hot and humid climates, the use of a Class I vapor retarder, in both exterior insulated and cavity insulated walls, creates extremely high MCs and RHs. These elevated MCs occurred regardless of interior RH and regardless of the insulation strategy. On the other hand, hot-dry climates do not possess sufficient ambient moisture to create significant air leakage condensation. Nonetheless, low vapor permeance interior membranes should be avoided in hot-humid climates.

### **3.4 Wall Performance**

To assess the moisture durability performance of high-R wall assemblies, a climate zone comparison study was undertaken. This enables comparisons to be made between wall types and climate zones to allow designers and builders to identify which wall types are best suited for their climates.

Each wall comprised identical interior and exterior construction (i.e., cladding and ventilation, interior finishes) and climatic boundary conditions for each respective climate zone; the primary differences are the types and locations of the insulating materials, and the presence and locations of any code-required vapor barriers. Each wall was also subjected to three types of moisture loads: construction moisture, air leakage, and bulk water leakage. The results are presented below.



### 3.4.1 Advance Framed Walls With Exterior Insulation

Advance framed walls employ efficient framing strategies to minimize the amount of thermal bridging through the wall and maximize the effective thermal resistance. The addition of exterior insulation acts to significantly reduce the effects of thermal bridging through the remaining framing members. For the purposes of this project it was assumed that all of the advance framed, exterior insulated walls employ sufficient exterior insulation to meet the requirements of the International Energy Conservation Code, as given in Table 10.

**Table 10. Exterior Insulation Requirements and Alternates for the Use of Class III Vapor Retarders (IECC 2012)**

Climate Zones	Minimum Exterior R-Value for Class III Vapor Retarder		Alternatives to Exterior Insulation
4	2 × 4	2.5	Vented cladding over wood structural panels
	2 × 6	3.75	
5	2 × 4	5	Vented cladding over wood structural panels
	2 × 6	7.5	
6	2 × 4	7.5	Vented cladding over fiberboard of gypsum
	2 × 6	11.25	
7 and 8	2 × 4	10	N/A
	2 × 6	15	

The values obtained from the International Energy Conservation Code are based on the thermal resistance of typical homes. High performance homes are usually more airtight and may have higher indoor moisture levels, especially if HVAC equipment cannot provide dehumidification or if humidifiers are used to maintain elevated humidity levels. Higher indoor RH levels necessitate the installation of greater amounts of exterior insulation (i.e., higher R-values) to keep the sheathing temperatures above the indoor dew point temperature. If the sheathing temperature does not fall below the interior dew point temperature, then air leakage condensation against the sheathing cannot occur. The ratio of the exterior insulation divided by the total wall R-value can be used to infer whether or not the sheathing will be at risk of air leakage condensation. Table 11 identifies the required insulation ratios such that air leakage moisture condensation does not occur for a range of indoor RHs and outdoor temperatures. For example, if an R-23 wall in an advance framed wall (not the effective R-value), building is located in a cold climate (−4°F) with an interior RH of 30%, then a minimum R-12.6 of exterior insulation is required to minimize interstitial condensation. The highlighted areas in Table 11 represent the required insulation ratio for the cities in climate zones 4, 5, and 7, based on the coldest 3-month average temperature (see Table 4) at the modeled, elevated interior RHs. The modeled advance framed wall has an insulation ratio of 0.46. Consequently, it is anticipated that International Falls and St. Louis, under their assumed higher indoor RHs, may have elevated sheathing MCs due to having a lower insulation ratio than required.

**Table 11. Insulation Ratio for a Given Interior RH and Outdoor Temperature**

(Straube 2010)

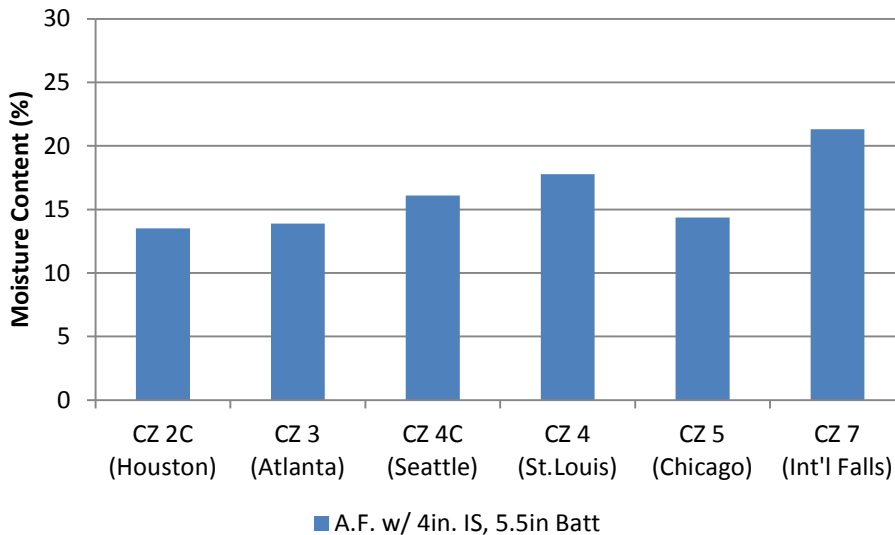
Indoor	RH	20	25	30	35	40	50	60
Dewpoint	°C	-3.0	0.0	2.5	4.7	6.6	9.9	12.7
	°F	26.6	32.0	36.6	40.5	44.0	49.9	54.8
T <sub>outdoors</sub>	°C							
	°F							
	10 50	0.00	0.00	0.00	0.00	0.00	0.00	0.24
	5 41	0.00	0.00	0.00	0.00	0.10	0.31	0.48
	0 32	0.00	0.00	0.12	0.23	0.32	0.47	0.60
	-5 23	0.08	0.19	0.29	0.37	0.45	0.57	0.68
	-10 14	0.23	0.32	0.40	0.48	0.54	0.64	0.73
	-15 5	0.33	0.42	0.49	0.55	0.60	0.69	0.77
	-20 -4	0.41	0.49	0.55	0.60	0.65	0.73	0.80
	-25 -13	0.48	0.54	0.60	0.65	0.69	0.76	0.82
	-30 -22	0.53	0.59	0.64	0.68	0.72	0.78	0.84

International Falls	Chicago	St. Louis	Seattle
---------------------	---------	-----------	---------

**3.4.1.1 Advance Framed, Exterior Insulated Walls—Baseline**

The baseline case follows from the boundary conditions listed in Section 2.1.4. If the peak MC never exceeds 20%, then it is very likely that decay will not happen to the sheathing. Figure 20 shows the peak daily sheathing MC for the selected cities.



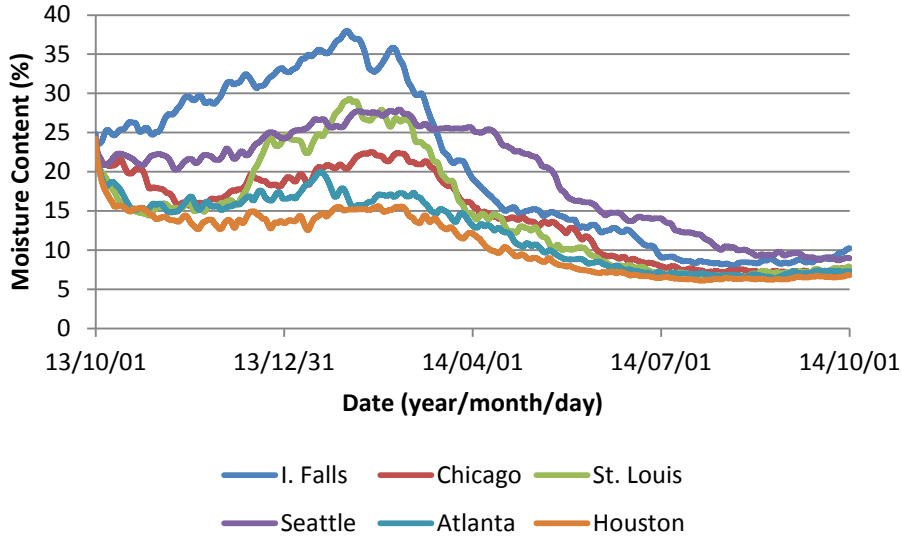
**Figure 20. Peak daily MCs for advance framed wall insulated walls in modeled locations**

Only in International Falls does the peak MC exceed 20%. However, if the insulation ratio in Table 11 were followed and a higher ratio of exterior insulation were installed, the peak MC would decrease to a safe 14%. In an R-30 wall, a minimum of R-16.5 of exterior of insulation is required to maintain a peak 14% MC for International Falls. The insulation ratio is an important factor when considering the surface temperatures of the interstitial surfaces of a wall assembly.

Maintaining elevated surface temperatures is of utmost importance for the durability of moisture-sensitive components in wall assemblies.

**3.4.1.2 Advance Framed, Exterior Insulated Walls—Construction Moisture**

Advance framed walls sometimes restrict outward drying, depending on the thickness and type of exterior insulation, the type and vapor permeance of the WRB, and whether or not a hygric, or moisture redistribution space is provided. Figure 21 shows the construction moisture drying rates for the advance framed walls.



**Figure 21. Advance framed wall insulated walls construction moisture drying**

The MCs in the sheathing of the walls all increase in the winter due to outward vapor diffusion and decreased sheathing temperatures (which results in increased RH and thus, higher MC). The very cold temperatures in International Falls yield sheathing temperatures that are below freezing—any residual moisture in the sheathing would turn to ice. This ice will melt in the spring and should not pose any problems to the sheathing; however, field experience suggests that mold and decay can occur on the top surface of the bottom plate as the result of sheathing meltwater. The Seattle wall experiences elevated MCs throughout the winter. In this situation, it is probable that mold will form on the sheathing. The times required for the sheathing to dry to 20% MC are shown in Table 12. In general, mold growth requires around 20–30 weeks in ideal conditions. While temperature fluctuations may interfere with any mold growth, it is likely that some degree of mold will be found in advance framed walls in International Falls and Seattle if the walls are sealed at the beginning of October and the wood materials were sealed at the simulated 28% MC. However, these results should not be taken without consideration of the inherent assumptions in these simulations. If these walls were finalized in the spring, the walls could dry out throughout the summer and the required drying times would be greatly reduced. These simulations represent a worst-case scenario.

**Table 12. Advance Framed Wall With Exterior Insulation Drying Times To Reach 20% MC**

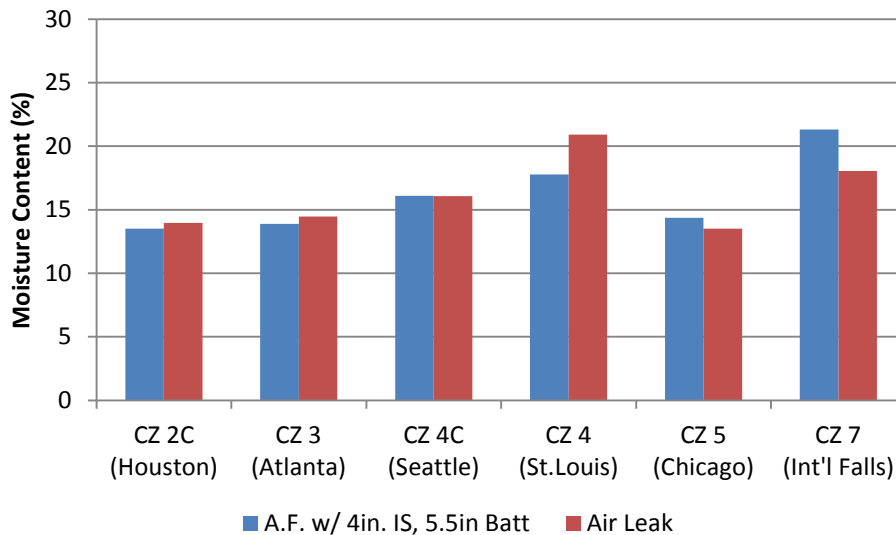
Climate Zone	Time To Reach 20% MC (in Weeks)
International Falls	25.8
Chicago	2.2
St. Louis	0.4
Seattle	31.6
Atlanta	0.3
Houston	0.3

The general conclusion that may be drawn from this simulation is that environments that are very cold (e.g., International Falls) or that are considered very wet (e.g., Seattle) negatively affect the drying times for the OSB sheathing. Hot climates, such as Houston, allow for greater drying capacities.

The reader should note that all of these simulations are based on idealized conditions. Empirical testing and forensic investigations are required to validate the durability of sheathing durability when exposed to construction moisture.

**3.4.1.3 Advance Framed, Exterior Insulated Walls—Air Leakage**

When 0.04 cfm/ft<sup>2</sup> at 4 Pa of indoor air is introduced immediately behind the sheathing, condensation can occur and the MC at the inside face of the sheathing can become elevated. Figure 22 demonstrates that advance framed walls are tolerant to air leakage.



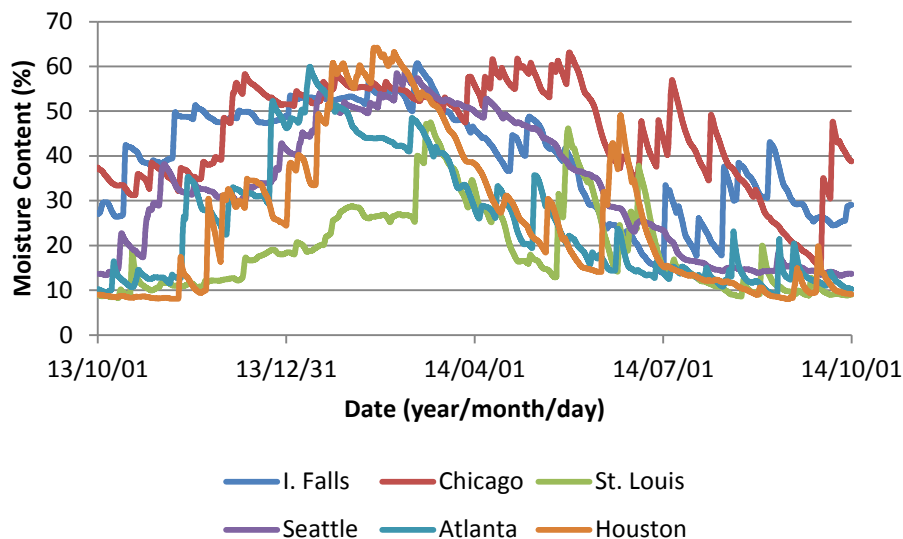
**Figure 22. Advance framed wall insulated walls peak MC with air leakage condensation**

Air leakage only marginally increases the sheathing MC. A balance of thermal energy and moisture deposits occur when a certain rate of air is injected into a cavity. Too much flow and the heat of the air will warm the surface; too little and there is insufficient moisture to appreciably increase the MC of the sheathing. In advance framed walls, the sheathing is typically

warmer than the dew point of the interior air and thus no significant amount of air leakage condensation occurs. The differences in sheathing MCs among the different climate zones are a function of the differing thermal resistances of the sheathing in each climate zone.

#### 3.4.1.4 Advance Framed, Exterior Insulated Walls—Bulk Water Leakage

Some problems were encountered when simulating a bulk water leak. The results of the simulation, with a leak of 5% of wind-driven rain, correlate well with forensic evidence of advanced moisture deterioration at leak sites. However, this added water sometimes causes convergence errors due to the enormity of the leak. In general, bulk water leaks totaling 5% of wind-driven rain must be avoided by using proper flashing and weather proofing techniques.



**Figure 23. Bulk water leak in advance framed walls with exterior insulation**

MCs exceeding 50% will not only provide ample moisture for mold and rot growth, but can also damage the adhesives used to bind the OSB. A 5% water leak will cause significant moisture damage to the walls. Consequently, proper water shedding details, and especially adequate overhangs, are of utmost importance.

#### 3.4.2 Hybrid Advance Framed Walls With 2 in. of Exterior Insulation, 2 in. of ccSPF, and 3.5 in. of Batt Insulation

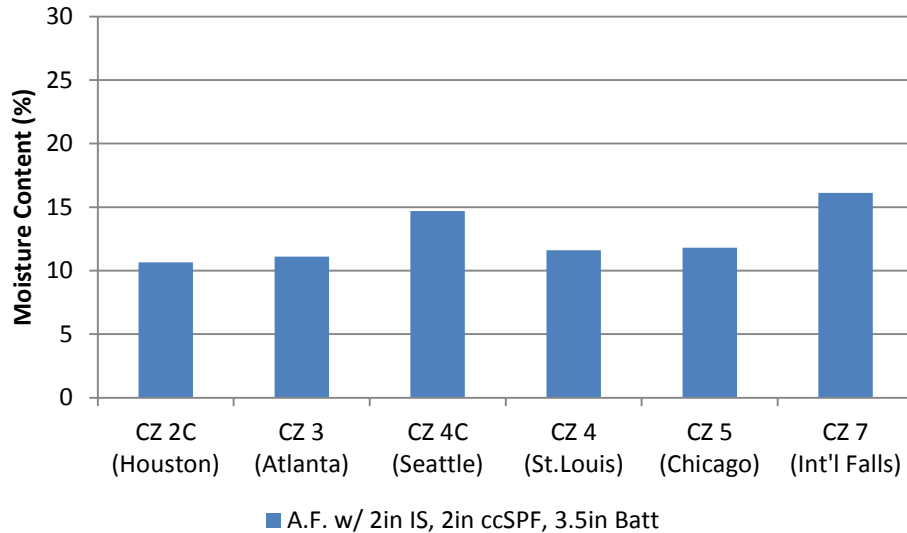
The hybrid advance framed wall is characterized by an advance framed wall with 2 in. of exterior insulation (XPS), to help reduce thermal bridging, 2 in. of ccSPF cavity insulation to help control air leakage and condensation, and finished with 3.5 in. of batt insulation for added insulation. While this wall does not provide the same level of thermal insulation as Wall 1: Advance Framed Wall with 4-in. of Exterior Insulation, it does meet the high-R criteria for climate zones 1 through 5.

The greatest concern with this wall assembly is the possibility to capture moisture in the OSB, as both the interior and exterior drying pathways are limited by closed cell foams (i.e., XPS exterior insulation or ccSPF on the interior). However, these concerns can be alleviated by using a more

vapor-permeable exterior insulation, such as mineral board or EPS board insulation, and ensuring that the OSB sheathing does not get wet subsequent to the installation of the ccSPF insulation.

### 3.4.2.1 Hybrid Advance Framed Walls—Baseline

The baseline MCs for the hybrid advance framed wall all fall below 20%, and are therefore considered low risk. The peak daily MCs for the modeled cities may be found in Figure 24.

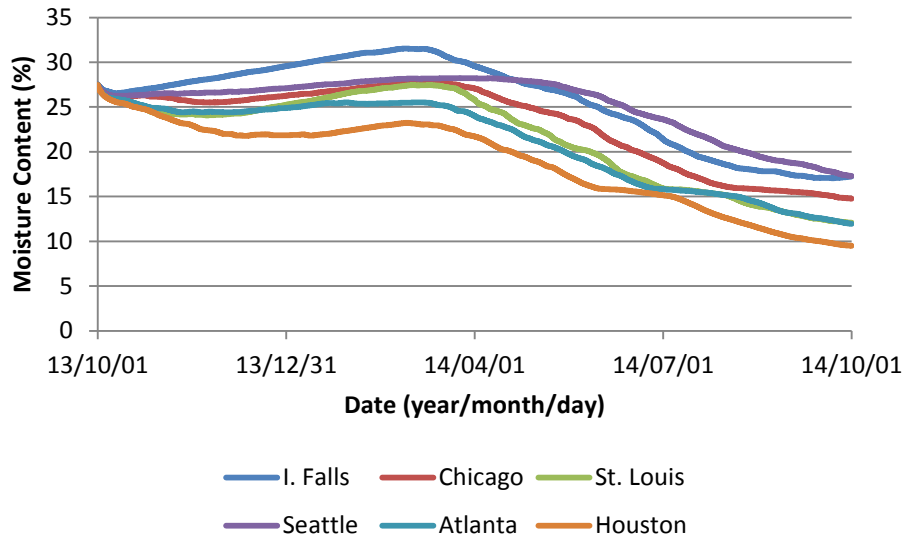


**Figure 24. Peak daily MC for hybrid advance framed wall insulated walls in modeled cities**

Despite a lower exterior board insulation ratio compared to the advance framed wall with 4-in. of exterior insulation, the MC of the OSB in International Falls is lower. The wall assembly benefits from the ccSPF’s ability to behave as an exterior insulation, by acting as the condensation plane instead of the moisture-sensitive OSB.

### 3.4.2.2 Hybrid Advance Framed Walls—Construction Moisture

Concerns related to inhibiting the drying capacity of the walls are justified when the drying rates are plotted for the hybrid wall in all climate zones. It should be noted that if the exterior OSB is protected from precipitation and moisture sources subsequent to the installation of the ccSPF, the conditions assumed (i.e., initial MC of 28%) are invalid. The intent of the model is to present potential drying rates for these wall assemblies and present worst-case scenarios. The results may be found in Figure 25.



**Figure 25. Hybrid advance framed wall insulated walls construction moisture drying**

Due to the inhibited drying routes, the moisture in the OSB sheathing remains trapped for prolonged periods of time. The required times to dry down to 20% MC are summarized in Table 13.

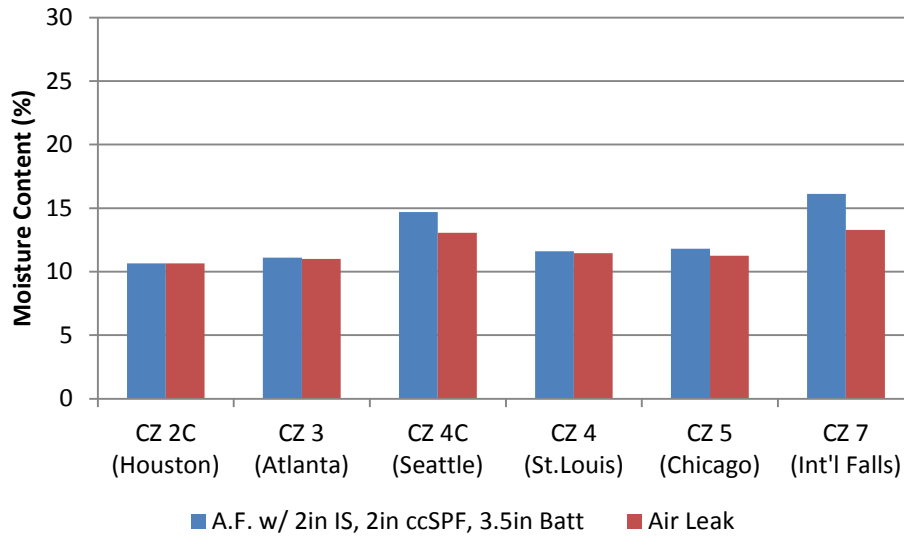
**Table 13. Hybrid Advance Framed Wall Drying Times To Reach 20% MC**

Climate Zone	Time To Reach 20% MC (in Weeks)
<b>International Falls</b>	40.8
<b>Chicago</b>	37.4
<b>St. Louis</b>	34.1
<b>Seattle</b>	44.7
<b>Atlanta</b>	32.3
<b>Houston</b>	28.6

As a result of these prolonged times at elevated MC, it is very probable that some degree of mold growth, or other moisture deterioration, would be found in such assemblies. OSB that is exposed to elevated MCs may experience adhesive failure and delamination. Consequently, hybrid wall assemblies should be allowed to dry prior to installation of either the interior ccSPF, or exterior insulation, such that at least unidirectional drying is provided.

**3.4.2.3 Hybrid Advance Framed Walls—Air Leakage**

When exfiltrating air is introduced into the system (adjacent to the interior surface of the ccSPF), the additional heat helps to slightly raise the temperature of the OSB. This is expressed by lower MCs in the OSB sheathing, as seen in Figure 26.



**Figure 26. Peak daily MC for hybrid advance framed wall insulated walls with air leakage in modeled cities**

The vapor resistance of the ccSPF effectively isolates the OSB from the interior conditions, as seen by the relatively dry MCs. Also, the additional heat source from the exfiltrating air helps raise the temperature of ccSPF just enough that the temperatures in the OSB are slightly elevated. Regardless, the MC of the sheathing does not exceed 20% at any point in any of the modeled climate zones.

#### 3.4.2.4 Hybrid Advance Framed Walls—Bulk Water Leakage

Similar to the bulk water leakage values in Wall 1: Advance Framed Wall with Exterior Insulation, the added moisture results in extremely high MCs throughout the entire year. The MCs are sufficiently high to not only harbor mold growth, but to likely cause adhesive failure of the OSB. The drying rates for such a leak may be inferred from the drying rates from the construction moisture simulations. The results suggest that if the OSB gets wet in such a hybrid system, it will remain wet for prolonged periods of time. This emphasized the importance of proper flashing and moisture details in walls built with vapor-resistant materials, such as ccSPF and board foams.

#### 3.4.3 Advance Framed Walls With 7.25 in. of ccSPF Cavity Insulation

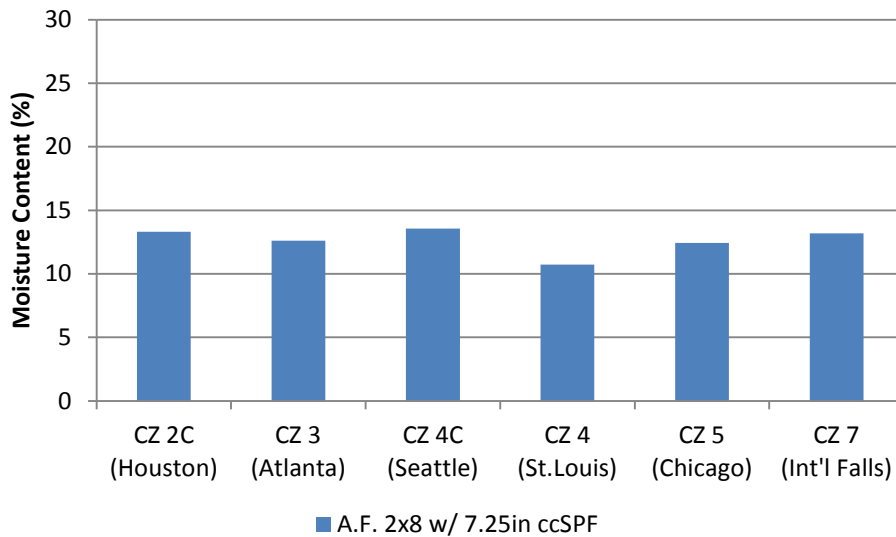
The use of an advance framed wall with 7.25 in. of ccSPF insulation is not very common. Combining the, albeit thermally superior, ccSPF in an already expensive structure (2 in. × 8 in.) may be cost prohibitive to certain builders, designers, and owners. However, the air sealing capacity of this assembly can be superior, provided that other air leakage pathways not covered by the spray foam (i.e., between the plates and the rim joists, plates and trusses, window and mechanical penetrations) are also sealed. Furthermore, the structural capacities of this wall system should be significant, as the structural contributions of spray foam can be significant (tensile strength of approximately 35 psi). Further, no additional vapor controls are required in this assembly, as the vapor permeance of 7.25 in. of ccSPF insulation as a Class I vapor retarder.



Due to the adhesive bond between the OSB and the ccSPF, it is extremely unlikely that any mold growth can occur on the interior side of the OSB—any mold that would grow would be exclusively on the exterior of the sheathing. This mold would hence be on the exterior of the air barrier and should pose no problems to the occupants.

**3.4.3.1 Advance Framed, ccSPF Cavity Insulated Walls—Baseline**

The baseline MC values are all quite similar for all climate zones. Despite the OSB sheathing experiencing near-outdoor temperatures year round, it is isolated from interior moisture from the vapor-resistant ccSPF insulation. The results of the peak daily MCs of the sheathing may be found in Figure 27.

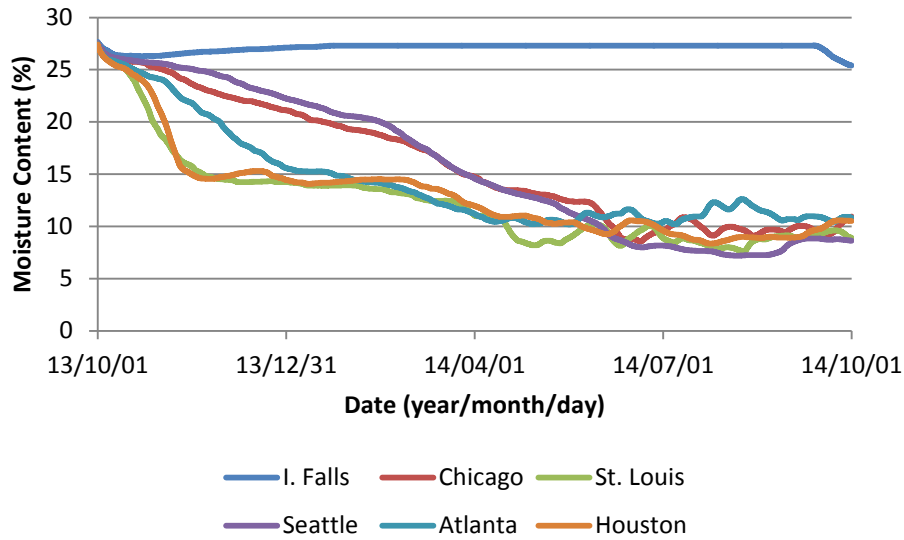


**Figure 27. Peak daily MCs for advance framed wall insulated walls with ccSPF cavity insulation in modeled cities**

As can be seen above, the MC of this assembly never exceeds 20%. These baseline moisture predictions suggest that this wall is low risk from a biodegradative standpoint.

**3.4.3.2 Advance Framed, ccSPF Cavity Insulated Walls—Construction Moisture**

The benefit of using ccSPF cavity insulation can also negatively affect the functionality of the building if construction moisture is present in the assembly. The ccSPF allows only one-way drying to the exterior.



**Figure 28. Advance framed wall with ccSPF cavity insulation construction moisture drying**

Even with unidirectional drying, most of the walls were able to dry to 20% MC in less than 20 weeks. The required drying times to achieve this MC are shown in Table 14.

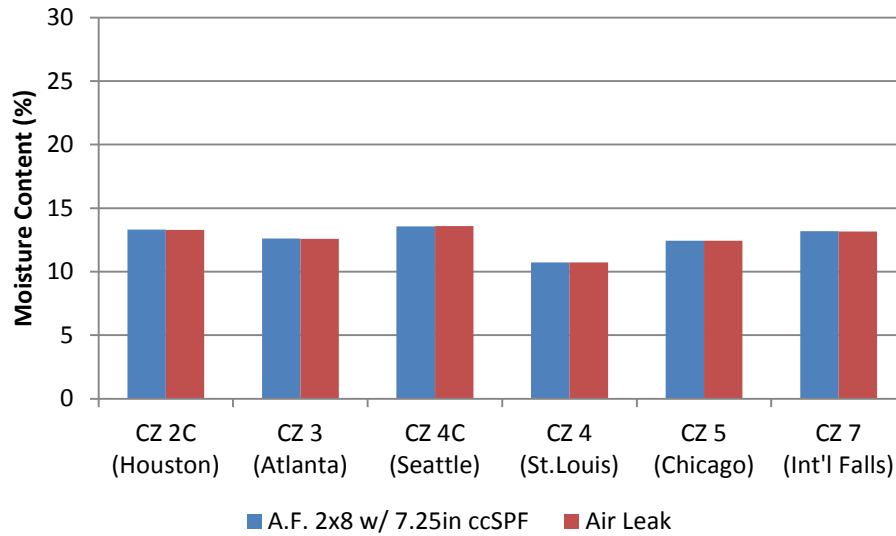
**Table 14. Advance Framed Wall With ccSPF Cavity Insulation Drying Times To Reach 20% MC**

Climate Zone	Time to Reach 20% MC (in Weeks)
International Falls	N/A
Chicago	15.6
St. Louis	3.9
Seattle	19.6
Atlanta	8.5
Houston	4.6

The wall located in International Falls experienced convergence errors due to the extremely low temperatures and elevated MCs of the sheathing. The results for International Falls should not be considered in evaluating the estimated drying times. It is imperative that once the ccSPF insulation is installed that the OSB sheathing is protected from any moisture sources, particularly precipitation. A saturated OSB sheathing with ccSPF insulation can result in moisture damage to the OSB.

**3.4.3.3 Advance Framed, ccSPF Cavity Insulated Walls—Air Leakage**

Since the ccSPF insulation effectively eliminates any convection between the insulation and the sheathing, the only plane for air leakage condensation is on the surface of the ccSPF, immediately behind the GWB. The results are shown in Figure 29.



**Figure 29. Peak daily MCs for advanced frame wall insulated walls with ccSPF cavity insulation and air leakage in modeled cities**

Since the plane of condensation is close to indoor temperatures, there is limited possibility for condensation. As can be seen above, the OSB is virtually isolated from the indoor conditions.

#### 3.4.3.4 Advance Framed, ccSPF Cavity Insulated Walls—Bulk Water Leakage

The advance framed wall with 7.25 in. of ccSPF insulation is as equally susceptible to bulk water leaks as all the other walls. A leaking window may deposit water on the window subsill structure, but it is unlikely that this water will leak down the interior side of the OSB. Instead, this water is likely to leak down the exterior face of the OSB. This will result in decreased drying times, as the required travel distance for drying is reduced. Essentially, the ccSPF helps contain and limits the potential leak. However, the leak will still cause significant localized deterioration of moisture-sensitive materials.

#### 3.4.4 Double Stud Walls With CFI and Polyethylene Vapor Barrier

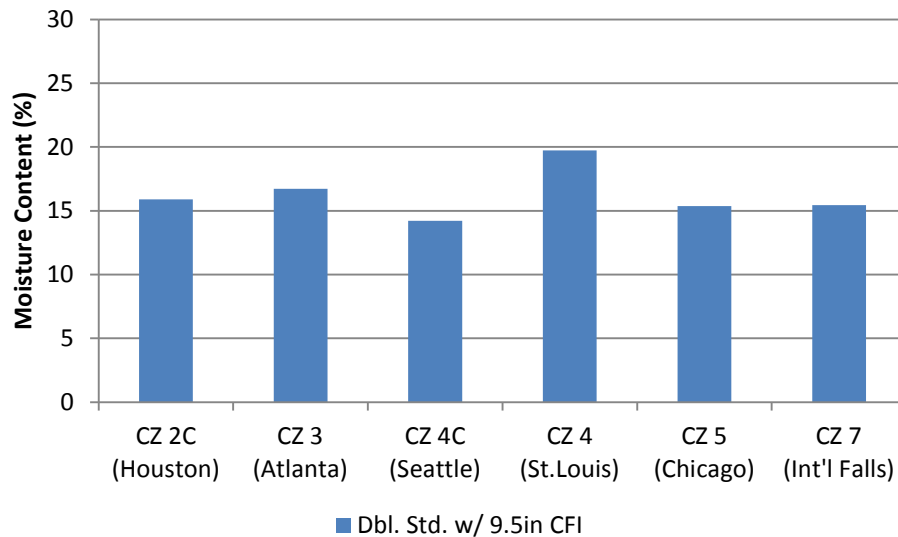
Double stud walls are used as high-R walls due to the low cost of insulation. Further, the structure is thermally broken, by having interior and exterior stud walls. A Class I or II vapor retarder is required in these walls in cold climates. Frequently, a polyethylene sheet will be suspended on the exterior side of the indoor framing structure. However, in climate zones 1 through 4 (not including climate zone 4: marine), no additional vapor control layers were included beyond the Class III interior latex paint.

The thermal benefits provided by double stud walls are also a source of concern regarding the moisture durability of the sheathing. A wall with significant cavity insulation will maintain sheathing temperatures close to those of the outdoor environment. This can pose a problem when sheathing temperatures drop below the dew point temperature of the indoor air. Air leakage can result in condensation formation on the sheathing, and the significant thermal resistance minimizes any thermal drying. The amount of cellulose used in double stud walls helps alleviate minor moisture concerns due to the significant moisture storing capacity of the cellulose.

However, if the cellulose’s storing capacity is exceeded, significant decay to the structure can occur. Cellulose treated with fungicides should experience biological growth only if sufficient liquid water is present to leach away these treatments. Cellulose without treatment would start to experience biodegradation with RHs in excess of 80%.

**3.4.4.1 Double Stud Walls With CFI and Polyethylene Vapor Barrier—Baseline**

The baseline MC readings for the modeled cities are shown in Figure 30.

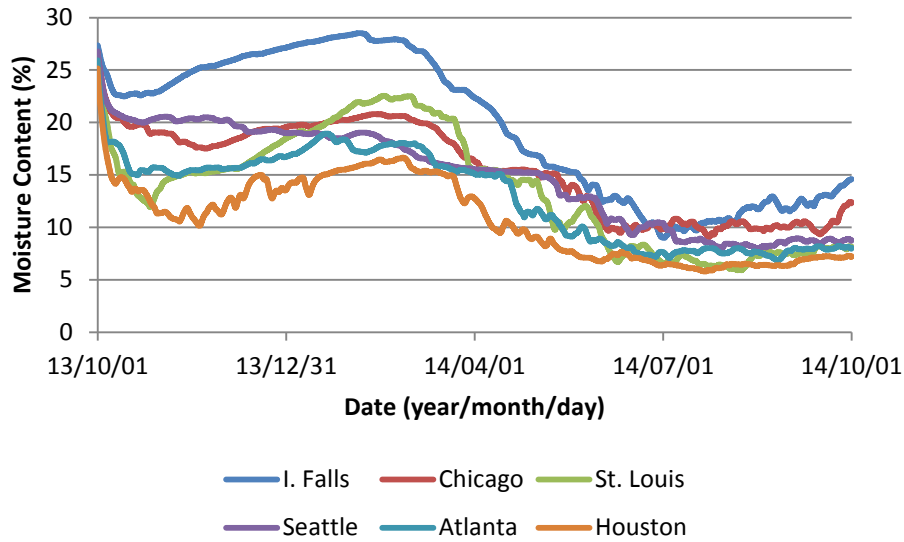


**Figure 30. Peak MCs for double stud walls in modeled cities**

Double stud walls with polyethylene sheets perform very well under ideal circumstances (e.g., no air leakage, no construction moisture, etc.). However, once real-world effects are introduced, such as an air leak, the material and design of double stud walls result in nonideal performances.

**3.4.4.2 Double Stud Walls With CFI and Polyethylene Vapor Barrier—Construction Moisture**

Some concerns exist that the use of a vapor barrier may inhibit the drying of walls should they get wet during construction. The following figure demonstrates the drying rate of the period of a year for these walls when exposed to construction moisture (28% MC for the OSB sheathing).



**Figure 31. Double stud walls construction moisture drying**

The immediate drying effects have a noticeable impact. This is due to the cellulose absorbing the construction moisture out of the OSB. However, once the cellulose reaches a saturated MC, it no longer absorbs moisture out of the OSB. Consequently, the OSB MC starts to rise during the colder winter months as it no longer has a proximate moisture sink to maintain a lower MC. The rapidity at which the OSB dries is demonstrated in Table 15.

**Table 15. Double Stud Walls Drying Times To Reach 20% MC**

Climate Zone	Time to Reach 20% MC (in Weeks)
<b>International Falls</b>	27.9
<b>Chicago</b>	1.9
<b>St. Louis</b>	0.6
<b>Seattle</b>	3.1
<b>Atlanta</b>	0.4
<b>Houston</b>	0.3

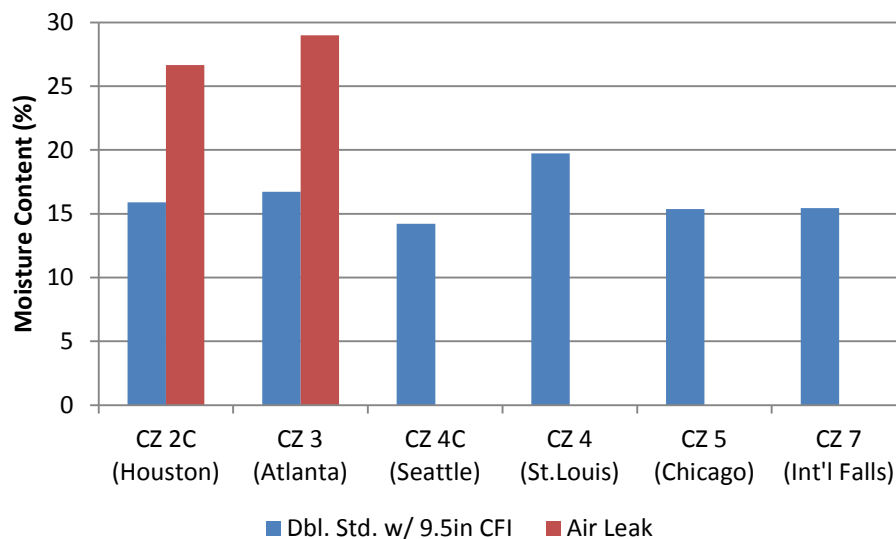
International Falls experiences prolonged durations (approximately 5 months) of nearly 28% MC in the OSB. This is a concern, as this elevated MC is sufficiently high to promote mold growth. Further, the elevated MC occurs over months where the ambient outdoor temperature is above 32°F.

While the drying rates are quite prolonged, and the peak MCs approach 28%, the borate treatment of the cellulose should be sufficient to mitigate any mold growth. Additional testing is required to verify the resistance of cellulose for a given duration at MCs in excess of 28%. Further research is required to verify if the anti-fungal treatment of the cellulose also provides benefits to the OSB.

In these simulations all of the construction moisture is assumed to be present in the OSB and none in the cellulose fiber insulation. The simulations might reflect a scenario in which the OSB is wet by rain water prior to application of the WRB on the outside and installation of the (dry installed) cellulose on the inside. Another less likely—but still plausible—scenario might be one in which the cellulose is installed prior to wetting. Under this second scenario a much larger volume of construction moisture could be built into the assembly (distributed between the OSB and the cellulose fibers located nearer to the outside of the assembly). Further research should be conducted to estimate the potential amount, distribution, and impact of moisture in this scenario.

**3.4.4.3 Double Stud Walls With CFI and Polyethylene Vapor Barrier—Air Leakage**

A sheet of polyethylene may be utilized to reduce wetting from outward vapor diffusion during colder weather but, unless it is properly sealed and detailed as an air barrier, it may not provide any benefit to air leakage condensation. Figure 32 demonstrates the difference in sheathing moisture content when air leakage is considered. Climate zones that do not include an MC for the sheathing when subjected to air leakage indicate that a convergence failure of the hygrothermal model occurred due to excessive moisture fluxes. It is to be assumed that the MC of the sheathing would exceed 28%.



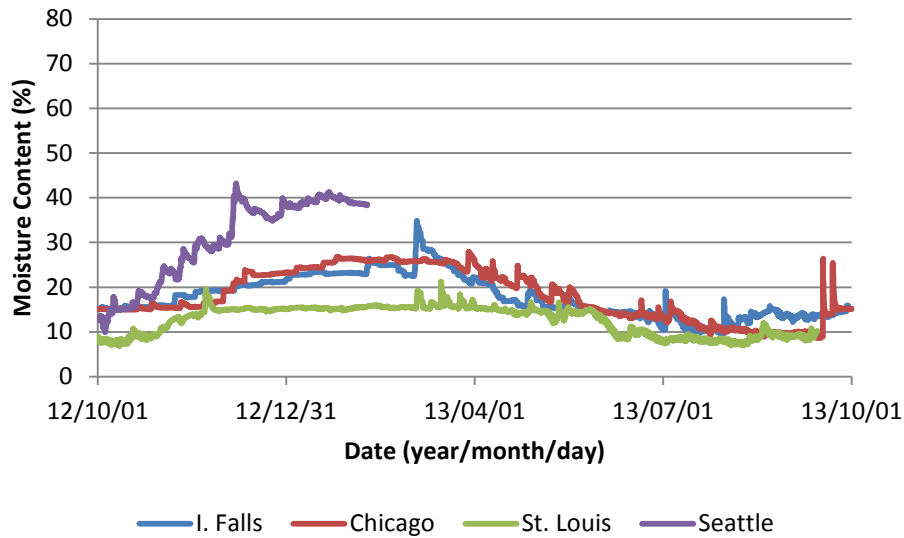
**Figure 32. Peak MCs for double stud walls in modeled cities, with and without air leakage**

When exfiltration air leakage is introduced into a double-stud wall, dangerously high moisture contents occur. The sheathing is outside of all of the insulation and tracks the outdoor temperatures closely. In the winter the sheathing is cold and air leakage condensation results in frost accumulation on the inside face of the OSB. The frost accumulation is expected to be much more significant than the frost accumulation predicted for the advance framed, exterior insulated wall assembly in International Falls (see Section 3.2). While the frost may not pose a direct problem, once sheathing temperatures rise above freezing, the meltwater leak can create elevated MCs within the sheathing and on the top surface of the bottom plate (as a result of run down). Significant amounts of moisture can be quickly absorbed into the cellulose insulation and may be present for long periods when thermal gradients are small (e.g., during swing seasons). All

efforts should be made to eliminate any air leakage into the wall cavity in double stud walls. An alternative is to consider using ccSPF as an air barrier to eliminate airflow to the back of the sheathing (considered later in this report).

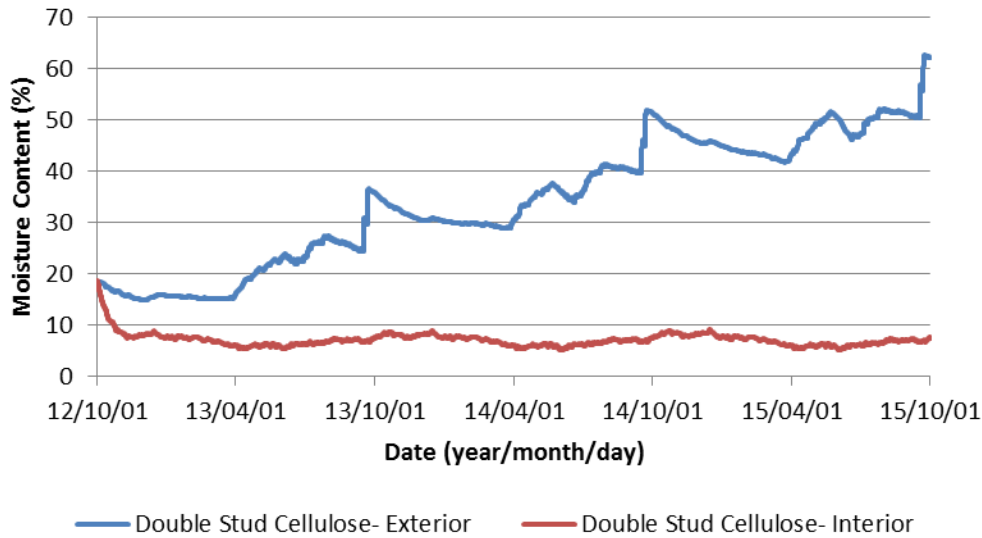
**3.4.4.4 Double Stud Walls With CFI and Polyethylene Vapor Barrier—Bulk Water Leakage**

Bulk water leakage is a serious concern for all wall assemblies. However, the predicted severity of the simulated leak in the double stud wall with cellulose is not as bad as in other simulated walls. The results from the simulation are found in Figure 33.



**Figure 33. Bulk water leak in double stud walls with exterior insulation**

The bulk water leak in the double stud walls does not appear as serious as in the advance framed walls with exterior insulation. This is due to the significant moisture-storing capacity of the cellulose. However, throughout the 3-year duration of the simulations, the MC of the cellulose increased every year. This suggests that the moisture from the OSB is absorbed by the cellulose. If the double stud wall is subjected to frequent and repeated wetting due to a bulk water leak, the limiting factor for the durability is no longer exclusively the OSB sheathing, but also the moisture durability of the cellulose. The MC rise in the cellulose over a 3-year simulation period may be seen in Figure 34.



**Figure 34. Cellulose MC for bulk water leak in Chicago**

The polyethylene sheet divides the interior frame cellulose and the exterior frame cellulose. The increasing MC of the exterior cellulose demonstrates that the polyethylene sheet is inhibiting inward drying, resulting in ever-increasing MCs.

If the polyethylene vapor barrier is eliminated, the wall assembly will be able to dry to the indoor side and the effects of the bulk water leak will be somewhat reduced; however, field experience suggests that bulk water leaks often overwhelm most drying mechanisms. Adequate water control details are paramount to ensuring the proper functioning of double stud walls.

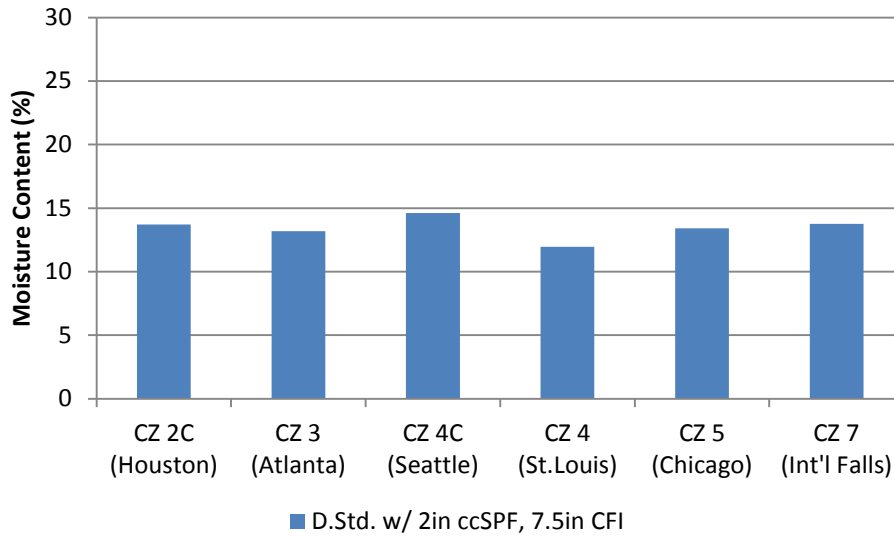
### 3.4.5 Hybrid-Insulated Double Stud Walls With ccSPF and CFI

The standard double stud wall concept can be improved through use ccSPF installed directly against the sheathing. The remainder of the framing cavity is filled with dry cellulose fiber insulation. This approach is said to employ a hybrid insulation strategy. By using at least 2 in. of ccSPF, air leakage condensation on the sheathing is eliminated and vapor diffusion is also controlled, as 2 in. of ccSPF is considered a Class II vapor retarder. Table R601.3.1 in the IRC states that for a 2 × 6 frame in climate zones 5, 7, and 8, you require at least R-7.5 to R-15 of ccSPF, respectively. As double stud walls possess more insulation, additional thicknesses of ccSPF are required to ensure the surface of the spray foam is maintained above the dew point temperature of the indoor air. In practice this is not typically done with double stud wall assemblies. If code ratios are followed to determine ccSPF thickness double stud wall assemblies perform well. However, if code table listed R-values are used instead double stud walls do not perform well. For the purposes of this report, the minimum R-value as specified by the code tables for 2 × 6 assemblies will be used to demonstrate a worst-case scenario. International Falls (climate zone 7) was modeled with 3 in. of ccSPF, while the other cities had 2 in. of ccSPF.

#### 3.4.5.1 Hybrid-Insulated Double Stud Walls With ccSPF and CFI—Baseline

The results from the baseline simulation of a double stud wall with ccSPF insulation may be found in Figure 35.



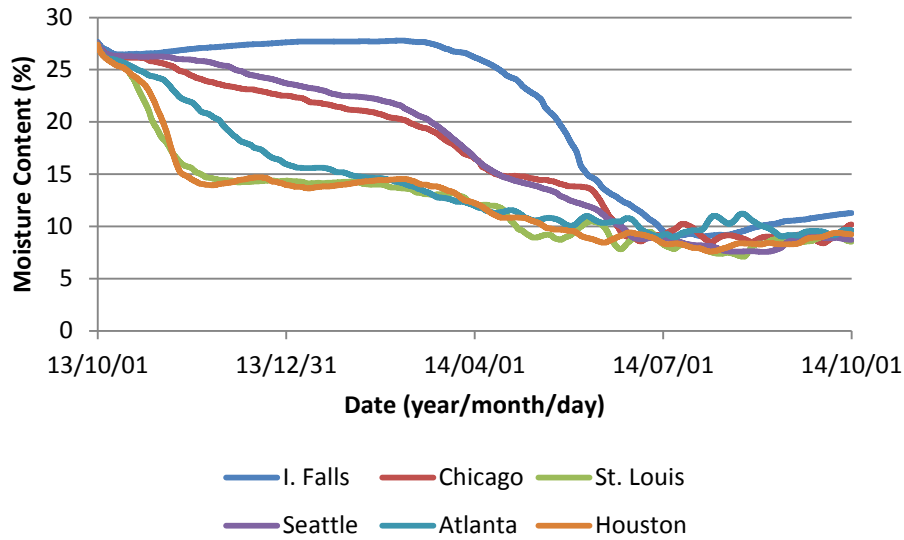


**Figure 35. Peak MCs for hybrid double stud walls with ccSPF in modeled cities after 3 years**

Under ideal conditions, the double stud wall with ccSPF performs only marginally better than the double stud wall with polyethylene sheet, a difference of only about 2% MC for each respective city. However, the benefits of using ccSPF become apparent when air leakage was considered (see Section 3.3.3).

**3.4.5.2 Hybrid-Insulated Double Stud Walls With ccSPF and CFI—Construction Moisture**

A double stud wall with 2 in. of ccSPF insulation on the interior of the sheathing will inhibit any inward drying. A spray foam installer following manufacturer’s recommendations should not install ccSPF on wood substrates in excess of 18% MC. However, this simulation creates a worst-case scenario wherein the OSB gets wet prior to the ccSPF installation. The results may be found in Figure 36.



**Figure 36. Hybrid-insulated double stud walls construction moisture drying**

The ccSPF clearly limits inward drying of the sheathing. MCs in excess of 20% last for approximately 6 months in climate zones 4C, 5, and 7. The required times to dry to 20% MC are shown in Table 16.

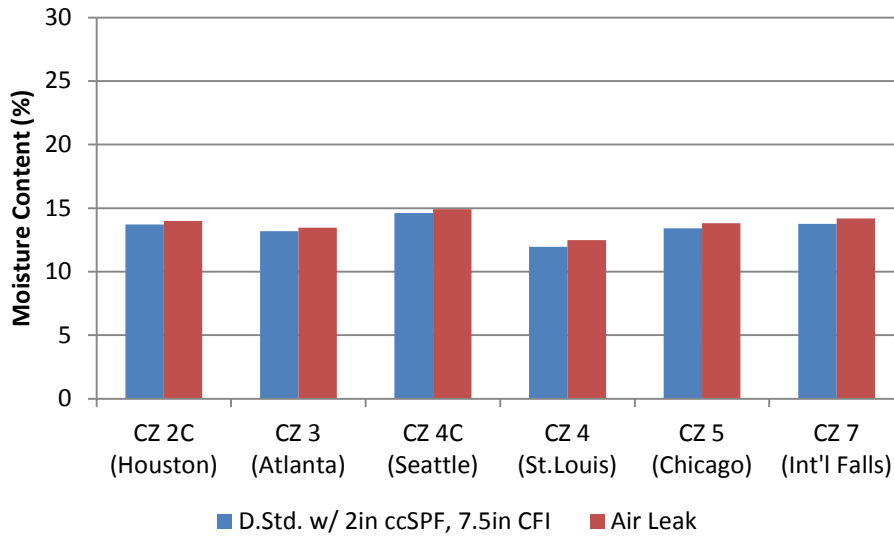
**Table 16. Hybrid-Insulated Double Stud Wall Drying Times To Reach 20% MC**

Climate Zone	Time To Reach 20% MC (in Weeks)
International Falls	31.9
Chicago	21.5
St. Louis	3.8
Seattle	23.1
Atlanta	8.5
Houston	4.5

The prolonged time of wetness poses a significant moisture risk. It is possible that the sheathing will experience moisture damage in the form of delamination and failure of the adhesives used to hold the wood fibers; mold and rot may also be problems, but the ccSPF will likely limit the mold growth on the exterior of the OSB. Additional research is required to verify the severity of the damage based on the quantity and duration of the moisture loads.

### 3.4.5.3 Hybrid-Insulated Double Stud Walls With ccSPF and CFI—Air Leakage

The use of ccSPF in double stud walls minimizes the effects of air leakage by providing a continuous air barrier that is also resistant to vapor diffusion. Figure 37 shows the peak sheathing MCs for the selected cities.



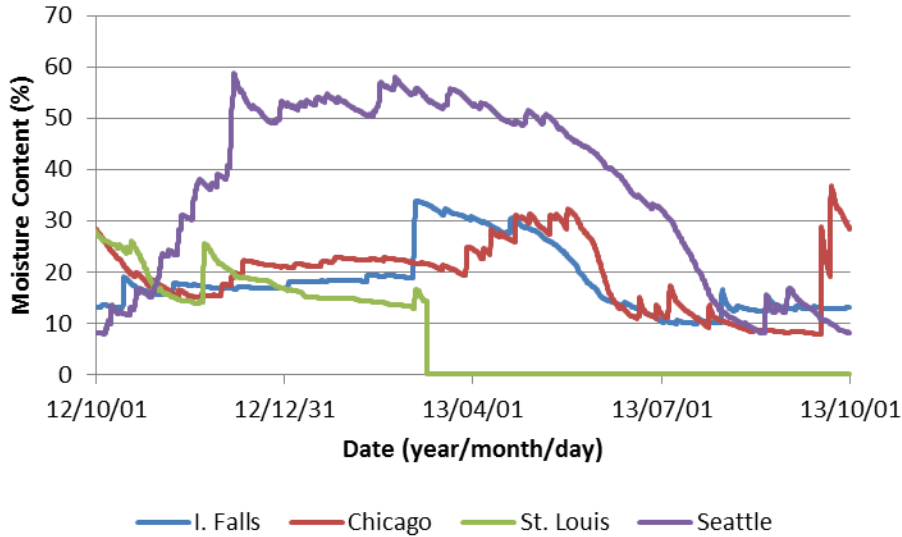
**Figure 37: Peak MC for double stud walls with ccSPF in modeled cities, with and without air leakage**

The use of ccSPF effectively minimizes air leakage condensation. Further, if the surface of the ccSPF is the condensing plane, the ccSPF is tolerant to moisture. It is possible that if sufficient condensation occurs on the ccSPF that it may run down and collect on the sill plate of the stud wall. However, dimensional lumber requires prolonged and very elevated MCs to be susceptible to mold. Furthermore, the borate treatment of the CFI functions as an anti-fungal.

In comparison with the standard double stud wall, the increased R-value of the spray foam results in warmer surface temperatures at the condensing plane. In the hybrid wall, this is the innermost surface of the ccSPF. Consequently, the use of ccSPF to prevent air leakage condensation is a sound method to improve sheathing durability by minimizing the exposure to warm interior air laden with moisture.

#### 3.4.5.4 *Hybrid-Insulated Double Stud Walls With ccSPF and CFI—Bulk Water Leakage*

When a small water leak is introduced into a double stud wall with ccSPF, the MC of the sheathing increases well beyond the fiber saturation point. Figure 38 demonstrates the severity of the bulk water leakage.



**Figure 38. Bulk water leak in hybrid double stud walls**

In a hybrid-insulated double stud wall with ccSPF, the sheathing is maintained at near outdoor conditions throughout the year. Wet sheathing may not dry quickly in cities that have climates with high outdoor moisture loads (i.e., high year-round RH with lots of precipitation). This is contrasted with cities that have climates more amenable to drying. This is exemplified by comparing St. Louis (climate zone 4) with Seattle (climate zone 4 marine). The sheathing in Seattle experiences MCs that would result in significant deterioration and failure. The bulk water leak in St. Louis resulted in a computation failure at the first major rain event. The performance of St. Louis, under the simulated conditions, for the rest of the year remains an unknown. However, it is anticipated that MCs of around 30% would occur, as in all the other cities.

The results of these simulations suggest that the sheathing in the other cities might be able to accommodate brief leaks, but due to the problems of the software being unable to account for liquid moisture on the surface of the materials, real-world conditions may not be adequately captured by the limitations of the software. Proper flashing and water barrier details, and especially properly sized overhangs, are required to minimize damage from bulk water leaks. Real-world testing is recommended.

### **3.4.6 Double Stud Wall With ocSPF Cavity Insulation**

A double stud wall filled with ocSPF is an inexpensive way to decrease the air leakage susceptibility of double stud walls commonly filled with cellulose insulation. The ocSPF acts to seal the OSB from any sources of air leaks between the exterior and interior stud walls. Further, while ocSPF is not considered vapor resistant, 9.5 in. of ocSPF behaves like a Class III vapor retarder (i.e., approximately 6 U.S. perms). While this is insufficient in colder climates, the ocSPF provides sufficient vapor resistance in climate zones 1 through 5, provided that there is a ventilated cladding, according to table R601.3.1. of the IRC 2012 building code. However, for the modeled walls, a Class I or Class II vapor retarder is required in climate zones 6 through 8. A polyethylene vapor barrier was therefore included in the International Falls simulation.

### 3.4.6.1 Double Stud Wall With ocSPF Insulation– Baseline

The results from the simulations suggest that ocSPF cavity insulation in a double stud wall can create conditions of elevated moisture content in the OSB sheathing. The high vapor permeability of the ocSPF enables water vapor to diffuse through the foams whereby it accumulates where it encounters a more vapor restricting surface; in this situation, the OSB.

As seen in Figure 39, the peak daily MCs are all dangerously high in all climate zones, with the exception of International Falls where a Class I vapor control layer was used. This is due to the significant moisture diffusion fluxes from the elevated indoor RHs. If the RHs were significantly decreased (i.e., from a less airtight building, or for a building with a well-designed HVAC system, a monitored and properly operated interior), the MC of the OSB sheathing would decrease significantly. The difference from 40% RH to 20% RH in Chicago may be seen in Figure 40.

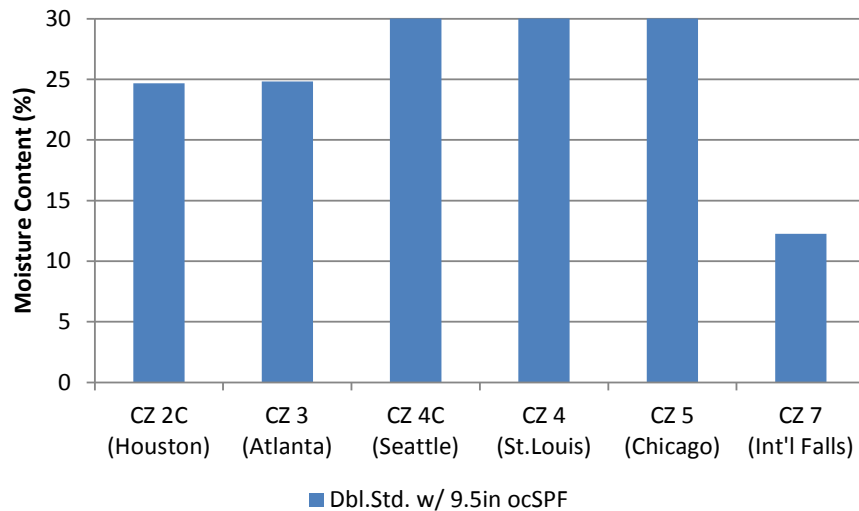


Figure 39. Peak MC for double stud walls with ocSPF in modeled cities

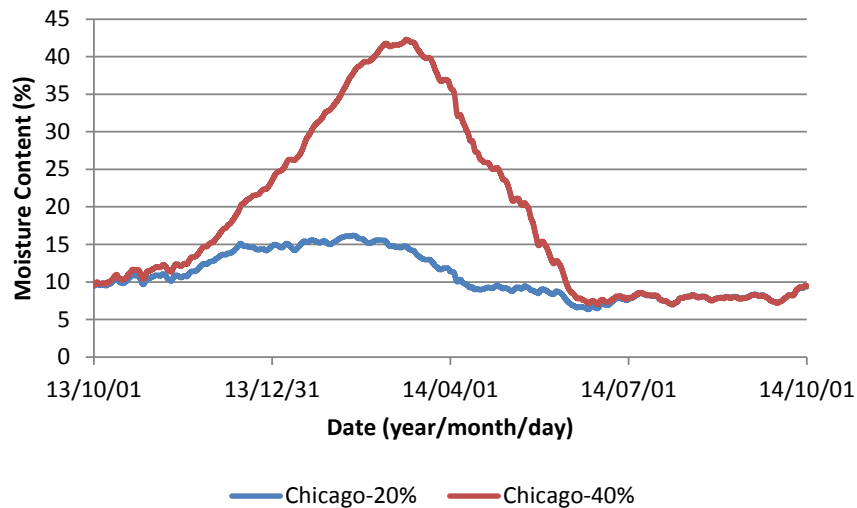
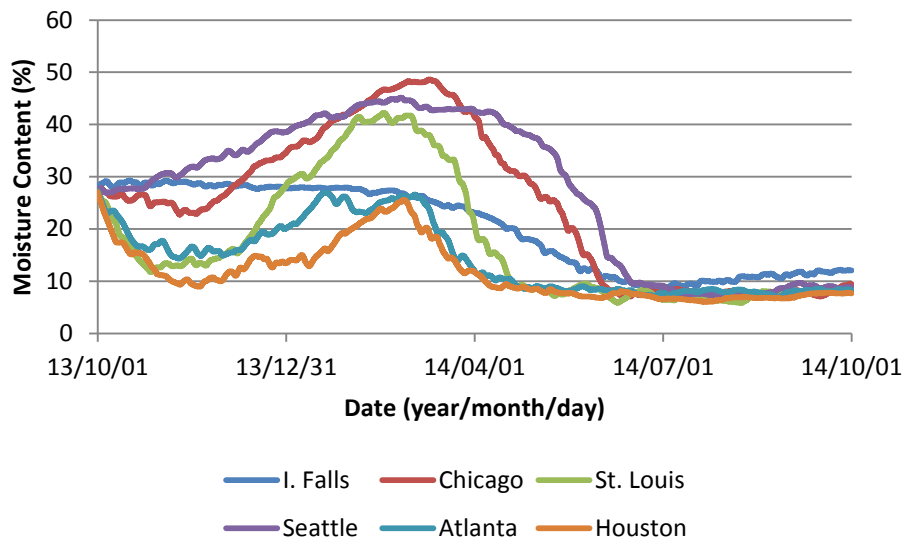


Figure 40. Annual peak daily MCs for 40% and 20% indoor RH in Chicago

The conclusion to be drawn from this analysis is that additional levels of vapor control are required for ocSPF walls in cold climates, unless the interior RH can be maintained at very low levels throughout the year. BSC recommends the use of a smart vapor retarder, which allows for drying by enabling increased vapor flows at high RHs or the application of a Class II vapor control coating to the interior face of the ocSPF to limit outward vapor drives in cold climates as is required for roof systems using ocSPF in the 2012 IRC.

**3.4.6.2 Double Stud Wall With ocSPF Insulation—Construction Moisture**

The vapor permeance of the ocSPF allows for interior drying of the wet OSB. However, in the colder climates, the outward flowing moisture from the humid indoor air easily overcomes the effects of inward drying, resulting in increasing MCs. The severity of this is such that it takes in excess of 28 weeks (7 months) before the International Falls, Chicago, and Seattle walls finally reach 20% MC (Figure 41).



**Figure 41. Construction moisture in double stud walls with ocSPF**

The required times for the walls to reach 20% MC are included in Table 17.

**Table 17. Double Stud Wall With ocSPF Drying Times To Reach 20% MC**

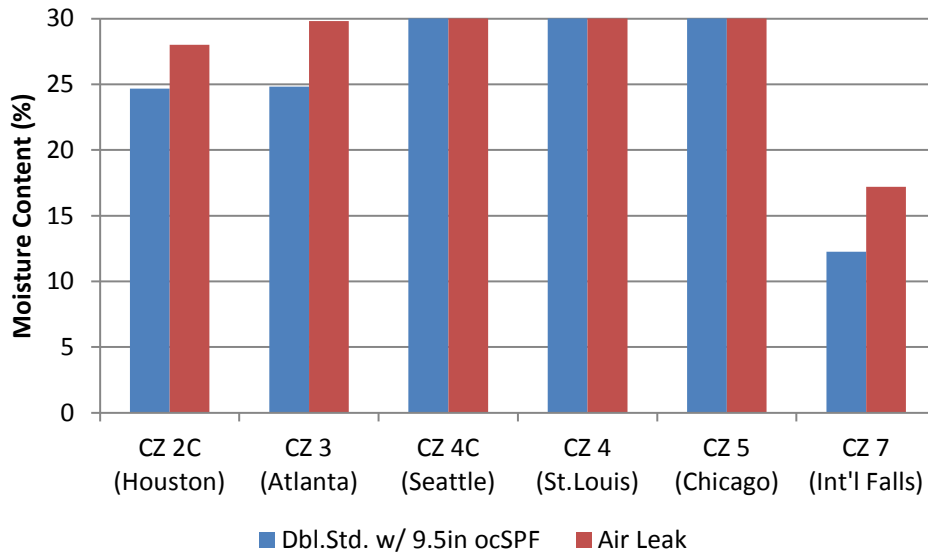
Climate Zone	Time To Reach 20% MC (in Weeks)
International Falls	28.9
Chicago	32.5
St. Louis	1.4
Seattle	34.8
Atlanta	2.0
Houston	0.9

While rapid drying rates are experienced in warmer or drier climates, the lack of outward flowing vapor control creates extremely long periods of time at elevated MCs in the colder climates.

While mold growth is unlikely on the interior surface of the OSB, other forms of deterioration are likely to occur.

**3.4.6.3 Double Stud Wall With ocSPF Insulation—Air Leakage**

The air seal afforded by the ocSPF ensures that the only plane for air leakage condensation is the innermost surface of the foam. This foam is maintained near interior temperatures, and therefore air leakage condensation levels are essentially eliminated. However, the air leakage carries with it additional moisture. This moisture is not restricted by the Class III vapor retarding paint, and therefore more vapor diffusion occurs through the foam, elevating the OSB MC.



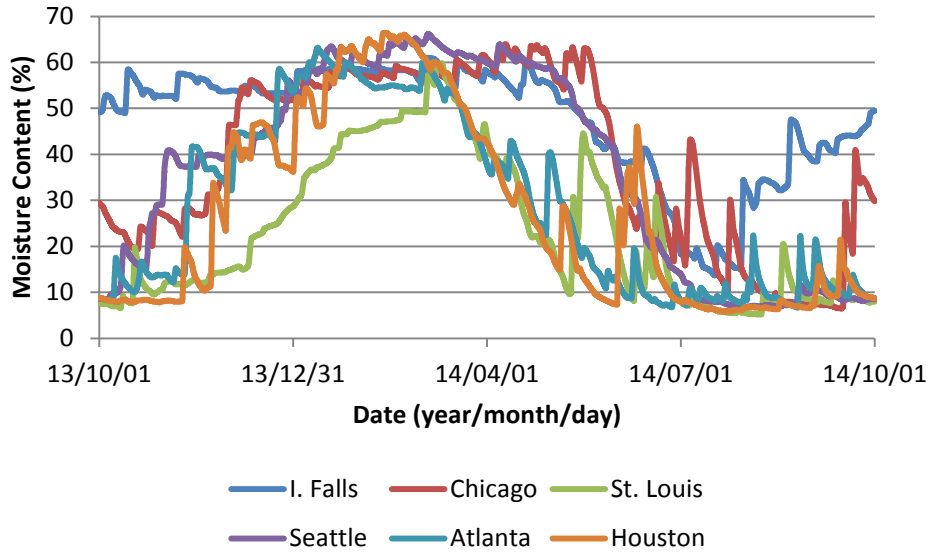
**Figure 42. Peak MCs for double stud walls with ocSPF in modeled cities, with and without air leakage**

With the exception of International Falls, which benefits from a vapor barrier, all of the wall assemblies experience dangerously high MCs. The advantage of spray foam, however, is that mold will have difficulty establishing itself between the spray foam and the OSB. It is much more likely that structural issues in the sheathing may occur due to adhesive and bond failure between the wood chips.

**3.4.6.4 Double Stud Wall With ocSPF Insulation—Bulk Water Leakage**

The high vapor permeance of the ocSPF provides ample drying capacity, both to the interior and exterior. This is demonstrated in the very fast drying rates for construction moisture. However, the inability of the ocSPF to control outward flowing water vapor negates the benefits of inward drying.

The benefits afforded by the Class I vapor barrier in International Falls eliminates the benefits of the inward drying of the ocSPF. However, in all the other walls, drying rates of 30% MC within the span of a month are possible during the summer months. However, elevated MCs recur during the winter. Relying on the drying capacity of ocSPF to accommodate for inadequate water detailing is not advised (Figure 43).



**Figure 43. Bulk water leak in double stud walls with ocSPF**

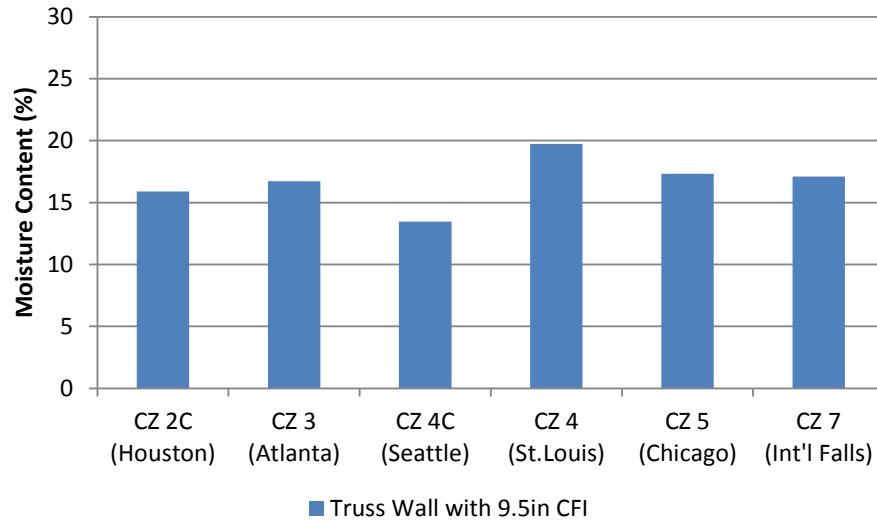
### **3.4.7 Truss Wall With CFI Insulation and Polyethylene Vapor Barrier**

The truss wall is a variation on the double stud wall approach, with the exception that thermal bridging is further reduced by intermittent gusset plates, which attach the exterior framing to the interior support. This helps reduce the thermal bridging effect of the floor structure to the exterior by cantilevering the insulation beyond the limits of the floor structure. However, in all other respects, the behavior of a truss wall closely approximates that of a double stud wall, including the sensitivity to air leakage condensation. A Class I vapor barrier was included in the models for climate zones 4C and higher. However, in climate zones 4 and lower, no additional vapor control layers were included beyond the Class III interior latex paint.

#### **3.4.7.1 Truss Wall With CFI Insulation—Baseline**

The primary difference between the truss wall and a double stud wall with cellulose insulation is the location of the polyethylene vapor barrier. In double stud walls, the polyethylene sheet is sometimes placed on the exterior side of the interior stud wall. On truss walls, however, the only location to place the vapor barrier is immediately behind the gypsum. This can aggravate the moisture durability of the wall when hot, humid outdoor conditions persist, as the moisture storage capacity of the cellulose fiber is not mediated by the vapor control layer (Figure 44).



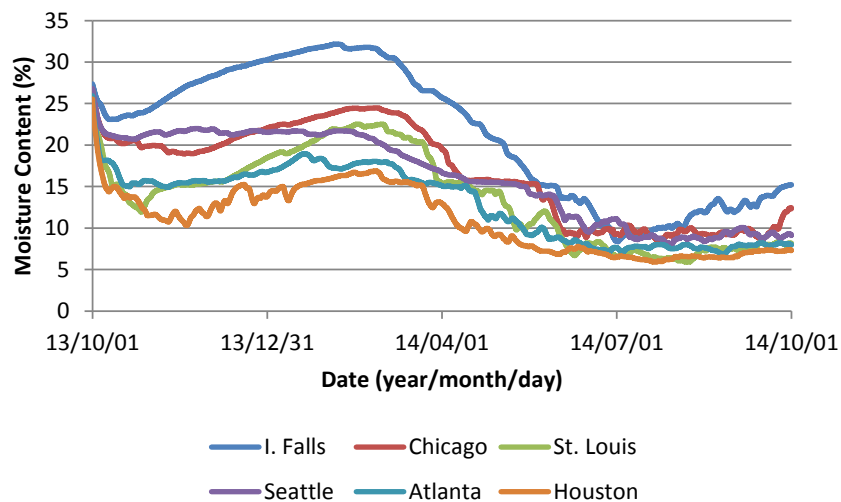


**Figure 44. Peak MCs for truss walls in modeled cities**

The baseline MCs for the truss wall are similar to those of the double stud wall, with the exception that the peak daily average MCs are slightly higher. This is likely due to the moisture-storing potential of the truss wall being greater than that of the double stud wall, due entirely to the placement of the vapor barrier within the assembly.

**3.4.7.2 Truss Wall With CFI Insulation—Construction Moisture**

The truss wall construction drying follows nearly the same patterns as the double stud wall, with the exception that the MCs are all slightly more elevated. The cause of this difference is the location of the vapor barrier. In the truss wall, a greater amount of the cellulose is exposed to the initial drying of the OSB, thereby absorbing a greater amount of water. The consequence of this is that over the winter, an increased amount of moisture is forced to the exterior due to thermal gradients through the insulation (Figure 45).



**Figure 45. Truss walls construction moisture drying**

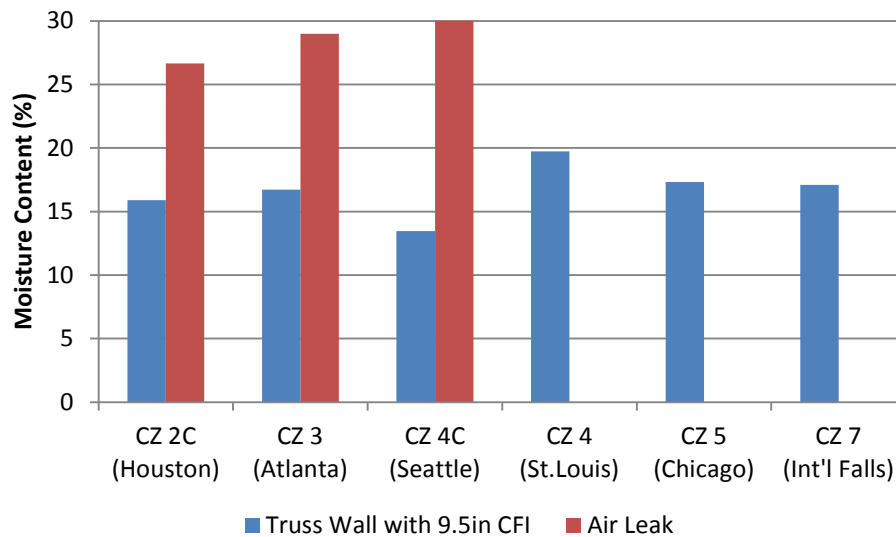
The drying rates and patterns of the truss wall are, again, very similar to those of the double stud wall, with the exception that the MC levels are slightly more elevated. The drying times to achieve 20% MC are provided in Table 18, below.

**Table 18. Truss Wall Drying Times To Reach 20% MC**

Climate Zone	Time To Reach 20% MC (in Weeks)
International Falls	30.7
Chicago	3.5
St. Louis	0.6
Seattle	21.7
Atlanta	0.4
Houston	0.3

**3.4.7.3 Truss Wall With CFI Insulation—Air Leakage**

As the sheathing of the truss wall is not thermally insulated from the outdoor conditions, the sheathing is frequently one of the coldest elements in the wall assembly. When air leakage is considered, significant condensation may form on the sheathing, as demonstrated in Figure 46.



**Figure 46. Peak MCs for truss walls with in modeled cities, with and without air leakage**

The degree of air leakage condensation can be so severe that in climate zones where a value is not provided indicate that significant convergence errors occurred in the simulation due to excessive moisture fluxes. For all intents and purposes, it can be assumed that the MC of the sheathing would exceed 28%. Even in hot climates (i.e., climate zones 2 and 3), the MCs in the assembly approach what is considered risky limits for the sheathing.

**3.4.7.4 Truss Wall With CFI Insulation—Bulk Water Leakage**

Similar to the double stud wall, the significant moisture storage of the cellulose in the truss wall partially masks the severity of a moisture leak if only analyzed over short periods. However,

once the cellulose insulation is charged, even relatively small changes in outdoor conditions (i.e. a cold snap) can cause the safely stored moisture to condense on cold surfaces. This results in elevated MCs of the sheathing and may, depending on the temperature, promote mold growth.

### 3.4.8 Structural Insulated Panels

SIPs are created by adhering structural sheathing (usually OSB) as a skin on a core of insulation (usually EPS). The benefits of SIPs pertain to possessing a continuous layer of insulation. The primary concern with SIPs is not the center of the panel performance, but at the joints between the panels. Forensic experience has identified numerous cases in which air leakage condensation caused significant damage along the edges of the panels. Air sealing methods have been developed to minimize this moisture risk; however, complex geometries and installer inexperience often result in imperfect joint air seals. Due to the limitations of using a one-dimensional model to simulate a two-dimensional problem, the SIPs were simulated in two ways. A clear panel simulation (i.e., center of the panel) was used to model the baseline simulation, construction moisture, and bulk water leakage. A joint between two SIPs panels was modeled to simulate air leakage.

#### 3.4.8.1 Structural Insulated Panels—Baseline

The baseline simulations were conducted for a clear section of the panels. The effects of the edges and joints in the panels were not considered. The baseline results from these simulations are shown in Figure 47.

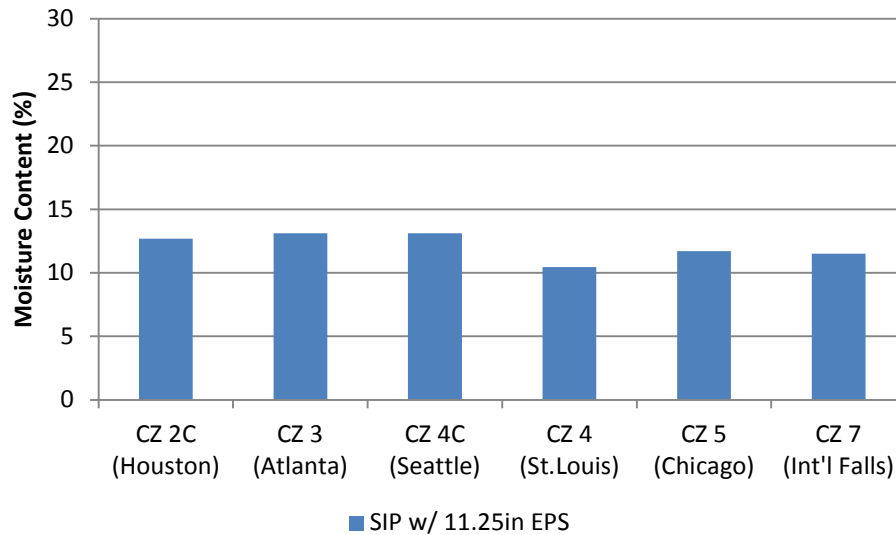
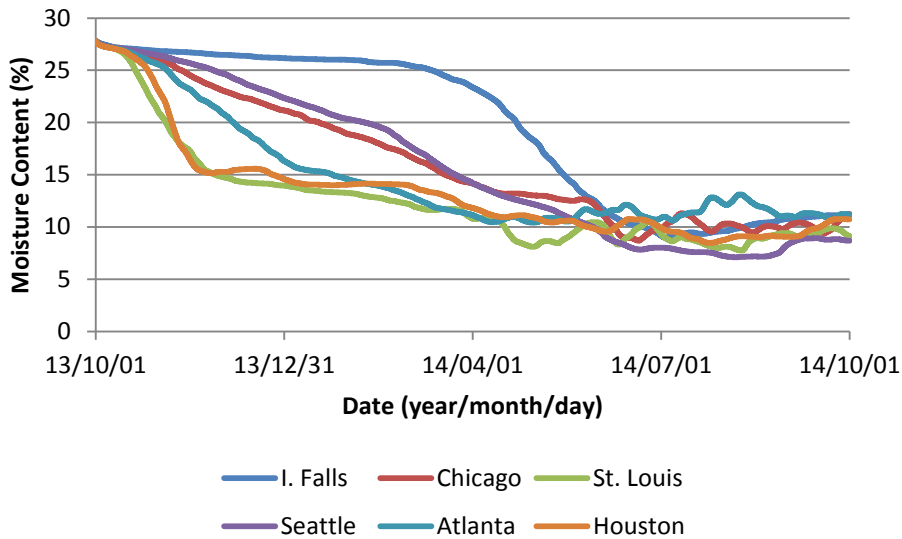


Figure 47. Peak MCs for SIPs walls in modeled cities

Due in large part to the significant thickness of the EPS core in the panels, which restricts vapor flows, very low MCs occur in the center of the panels. In ideal circumstances, SIPs panels perform well in a range of climates.

### 3.4.8.2 Structural Insulated Panels—Construction Moisture

The model used to assess construction moisture drying assumed a section through the center of the panel. Due to the thickness of the EPS core, drying to the interior is restricted. Consequently, only exterior drying occurs. As exterior drying is highly dependent on the exterior environment, a strong correlation between drying rate and outdoor temperature and RH occur. This is demonstrated in Figure 48, with a slow drying rate for International Falls and the fast drying rate for St. Louis.



**Figure 48. SIP walls construction moisture drying**

Due to the cold temperature, the SIPs in International Falls take nearly 6 months to dry. When construction moisture is considered, the SIP’s exterior OSB skin appears to be subject to the same moisture risk as the OSB sheathing in the hybrid-insulated double stud wall. Some damage may occur to the OSB sheathing. The drying times for the OSB to reach an MC of 20% are shown in Table 19.

**Table 19. Hybrid Advanced Frame Wall Drying Times To Reach 20% MC**

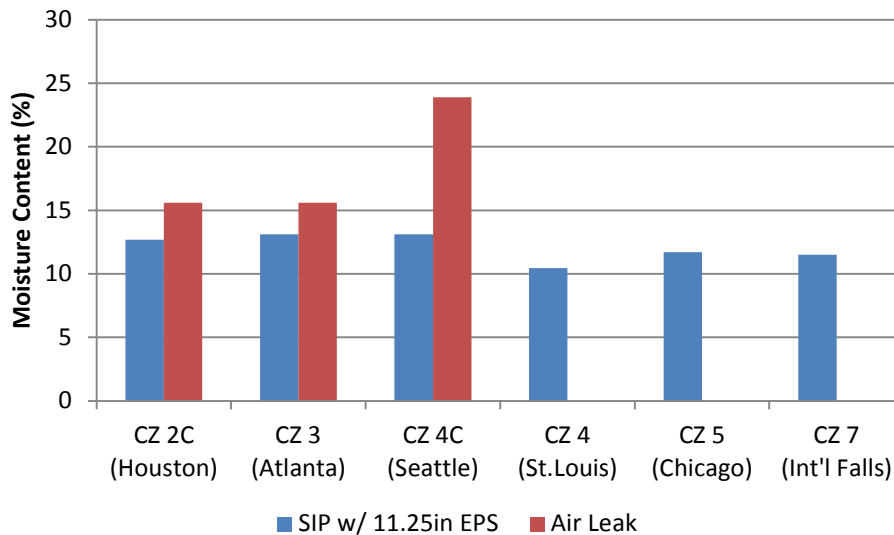
Climate Zone	Time To Reach 20% MC (in Weeks)
<b>International Falls</b>	29.1
<b>Chicago</b>	15.5
<b>St. Louis</b>	4.9
<b>Seattle</b>	18.6
<b>Atlanta</b>	9.5
<b>Houston</b>	5.3

Additional field research is required to verify the severity of this damage. The panels in Chicago and Seattle are predicted to also be at risk from prolonged times at elevated MCs, but the effects of the severity and duration of the moisture load are not well known or researched. Additional

research is required to verify the moisture durability of SIPs when exposed to elevated MCs in the central areas of the panel membranes.

### 3.4.8.3 Structural Insulated Panels—Air Leakage

The primary issue with SIPs is not air leakage through the middle of the panels, but at the joints. Significant moisture damage has occurred in buildings constructed with SIPs that were not properly air sealed along the joints. Consequently, the simulations modeled air leakage through a section at the joint. It was assumed that a small air leak bypassed the foam air barrier and deposited itself immediately behind the exterior OSB spline. The results may be found in Figure 49.



**Figure 49. Peak MCs for SIP walls in modeled cities, with and without air leakage**

Climate zones that do not include an MC value indicate that a convergence failure of the hygrothermal model occurred due to excessive moisture fluxes. It is to be assumed that the MC of the sheathing would exceed 28%.

No air leakage value was included in International Falls due to convergence errors. The air leakage condensation was so significant that could not be absorbed by the OSB and the simulation crashed. In all the other climates, with the exception of Atlanta (where the outdoor temperature infrequently dips below the dew point of the interior air), dangerously high MCs occur. The results of the simulation suggest that SIPs that are not adequately air sealed are prone to risk of air leakage damage.

No moisture risk was predicted at the SIP joint when exfiltration air leakage is simulated using the Miami climate; however, in Miami, infiltration air leakage can introduce moisture to and cause condensation at the outdoor side of the interior OSB skin and spline at the indoor side of the panel joint. Further research should be conducted to assess this potential risk.

#### **3.4.8.4 Structural Insulated Panels—Bulk Water Leakage**

Significant calculation errors occurred when bulk water leakage was simulated in the SIPs. Due to restrictions toward inward drying, and minimal moisture storage capacity of the EPS insulation, water quantities that exceed the storage capacity of the OSB occurred. The errors are a result of the modeling software being unable to account for liquid water on the surface of the material.

The only pertinent information obtained from the simulations is that bulk water leakage into a SIP wall can result in significant moisture accumulation. This water can cause a range of damage from delamination of the adhesives in the OSB or plywood skins of the panels, to the potential of mold and rot growth.

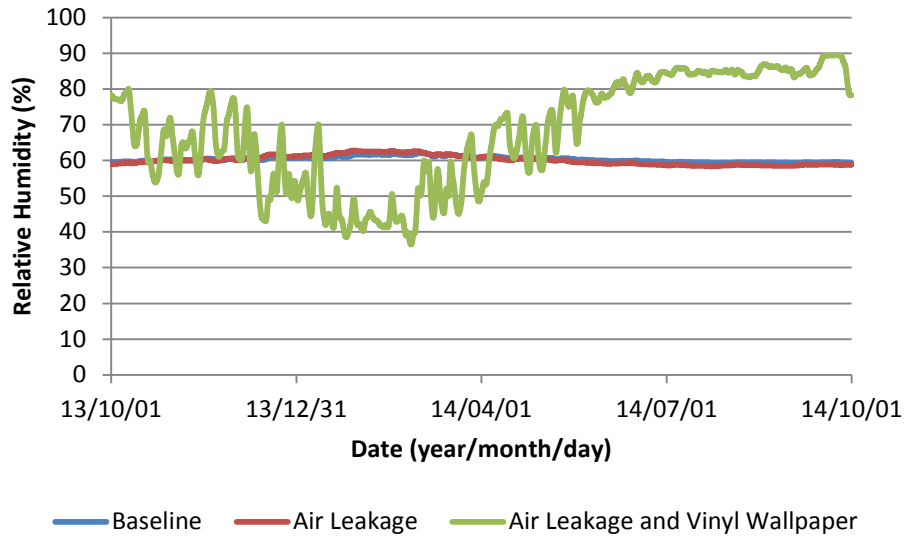
#### **3.4.9 Concrete Block Wall With 3.5 in. of Exterior Insulated Finishing System**

The benefits of a high-R value assembly are typically of more value in cold climates. Also, the majority of residential buildings in U.S. cold climates tend to be of wood stick framed construction. Consequently, this report is primarily focused on high-R value, wood structure residential buildings. However, moisture-tolerant, high-R walls in hot climates may also provide benefits in reduced energy costs for air conditioning, although the required level of insulation is much less than in cold climates. Many hot and humid coastal areas of the United States use concrete blocks as their primary building structures. Therefore, a high-R value assembly, with R-14 of exterior insulation, featuring a CMU supporting wall, was analyzed.

Since very little wood is used in masonry construction, the area of foremost concern for moisture damage now becomes the GWB. In general, 80% RH is the lower limit for mold growth on paper-faced gypsum, but these conditions do not necessarily indicate that mold growth will occur. In general, significant mold growth will only start to occur once RHs approach the 90% level. For the purposes of this report, if sustained levels of 90%+ RH occur on the back side of the GWB, then this is considered extremely risky. However, if the RH surpasses 80%, but then falls below the lower threshold, this will be considered as only a moderate level of risk. If the RH never exceeds 80%, then it is considered safe.

##### **3.4.9.1 CMU With 3.5 in. of EIFS—Baseline, Air Leakage, and Vinyl Wallpaper**

The RHs and temperatures were recorded immediately on the outside and inside surfaces of the GWB Houston, in climate zone 2C. The results are plotted throughout the year, as seen in Figure 50.

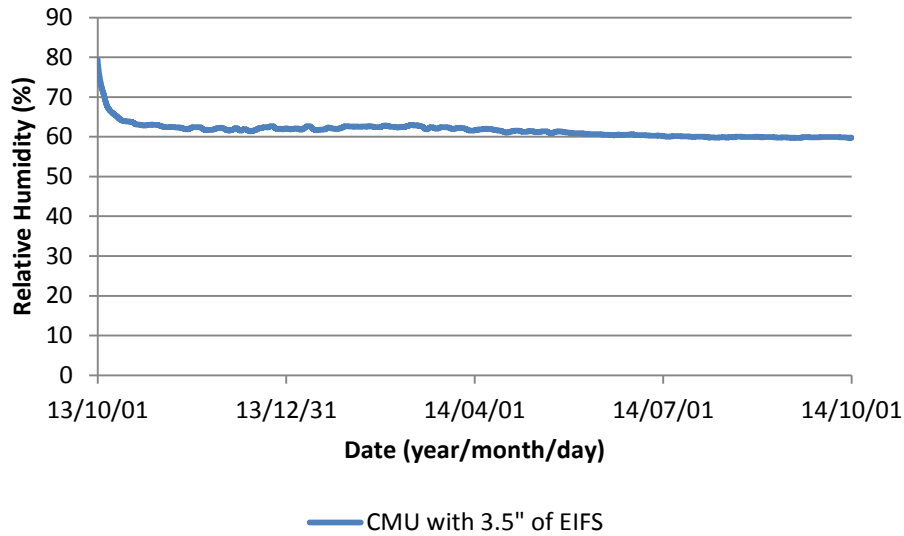


**Figure 50. Yearly peak daily RHs at the GWB surface for CMU walls—baseline, air leakage, and air leakage and vinyl wallpaper**

Even with air leaking into the cavity space of the assembly, the RH does not exceed 60%. This is a result of not including any types of interior vapor resisting layers, such as vinyl wallpaper, or at areas of low vapor permeance finishes, such as cupboards, mirrors, and glazed tiles. As soon as a low permeance layer such as vinyl wallpaper is included in the simulation, the RH on the paper faces of the GWB reach up to 90%. It is very probable that mold will germinate and grow under such conditions. It is therefore extremely important that no vapor-retarding interior finishes are installed in this assembly in this type of climate.

#### 3.4.9.2 CMU With 3.5 in. of EIFS—Construction Moisture

By constructing a wall system that does not inhibit inward drying, very fast drying times may be achieved. The MC rapidly drops from 80% to 60%, which matches the modeled indoor conditions. Based on the results of the drying simulation, the risk of mold growth on the GWB is very low (see Figure 51).



**Figure 51. CMU wall with 3.5 in. of EIFS construction moisture drying**

### 3.5 Wall Summary

The results of these simulations provide the anticipated moisture performance of the proposed wall assemblies when exposed to a range of simulated moisture loads. While extensive effort was undertaken to ensure that the parameters and values used are representative of actual, real-world conditions, no large-scale, empirical testing of the moisture durability of wall assemblies has been undertaken.

Consequently, to summarize the results of simulations, a table was produced with a general risk assessment for each proposed wall type. These values are all based on a 2.5 ACH50 whole-building air leakage, as the idealized simulations that do not include air leakage do not provide realistic results.

A “low risk” assembly in a given climate is not likely to experience a single peak average day MC in excess of 20%. A moderate risk assembly is not likely to experience a daily peak MC in excess of 28%. While there is a high probability that mold will grow on these assemblies, it is likely to be limited and/or negligible. A high risk assembly is likely to experience multiple days of peak daily MC in excess of 28%. Not only is this assembly likely to experience mold growth, the mold may be toxigenic. In general, walls with exterior insulation, or cavity insulation that behaves like exterior insulation (i.e., ccSPF), have a much lower risk than walls with exclusive cavity insulation (see Table 20).



**Table 20. Moisture Durability Risk for Proposed Wall Assemblies in Select Climate Zones, Including Air Leakage**

Modeled Climate Zone	Modeled City	Wall 1: Advance Frame With 4 in. IS, 5.5 in. Batt	Wall 2: Advance Frame With 2 in. IS, 2 in. ccSPF, 3.5 in. Batt	Wall 3: Advance Frame 2 × 8 With 7.25 in. ccSPF	Wall 4: Double Stud With 9.5 in. CFI	Wall 5: Double Stud With 2 in. ccSPF, 7.5 in. CFI	Wall 6: Double Stud With 9.5 in. ocSPF	Wall 7: SIP With 11.25 in. EPS	Wall 8: Truss Wall With 9.5 in. CFI
2C	Houston	Low	Moderate	Low	Moderate	Low	High	Low	Moderate
3	Atlanta	Low	Low	Low	High	Low	High	Low	High
4C	Seattle	Low	Low	Low	High	Low	High	Moderate	High
4	St. Louis	Moderate	Low	Low	High	Low	High	High	High
5	Chicago	Low	Low	Low	High	Low	High	High	High
7	Int'l Falls	Low	Low	Low	High	Low	Moderate	High	High

### 3.6 Cost Considerations

High-R walls are specialized assemblies designed to provide significantly better thermal performance, comfort, and moisture durability relative to standard or conventional wall assemblies. High-R walls have not been adopted by any large production builders; however, a number of smaller (i.e., fewer than 50 units/yr) builders have successfully developed near net-zero energy houses that employ high-R wall assemblies (Ueno et al. 2012).

When analyzed from a strict capital cost or energy payback period (neglecting ancillary costs, such as space heating costs during construction), high-R walls are not cost competitive with the code minimum wall. The reason is because the standard code wall does not provide the same level of R-value than high-R walls. Table 21 and Table 22 summarize the costs for a conventional code-built wall assembly and the four walls analyzed in this report. Conventional walls appear to be less expensive because they use fewer building materials and have lower labor costs. To make the comparison more relevant, analyzing the cost per R-value normalizes for the differing thermal resistances of the walls.

**Table 21. Total and Area Cost for Advance Framed High-R Walls<sup>1</sup>**

	Conventional “Code-Built” Wall		Exterior Insulated, Advance Framed Wall		Exterior Insulated, Hybrid Advance Framed Wall		Advance Framed Wall- 7.25 in. ccSPF Cavity	
	Product	Cost (\$)	Product	Cost	Product	Cost (\$)	Product	Cost (\$)
<b>WRB</b>	Tyvek	0.35	Tyvek	0.35	Tyvek	0.35	Tyvek	0.35
<b>Exterior Insulation</b>	NA		4-in. FF PIC (R- 24)	3.54	2-in. FF PIC (R- 12)	1.77	NA	
<b>Exterior Sheathing</b>	7/16 in. OSB	0.98	7/16 in. OSB	0.98	7/16 in. OSB	0.98	7/16 in. OSB	0.98
<b>Framing</b>	2 × 6 @ 16 in. o.c.	4.32	2 × 6 Adv @ 24-in. o.c.	3.57	2 × 6 Adv @ 24-in. o.c.	3.57	2 × 8 Adv @ 24-in. o.c.	3.89
<b>Frame Insulation 1</b>	FG batt (R-22)	1.17	FG batt (R-22)	1.17	2-in. ccSPF (R-10)	1.66	7.25 in. ccSPF (R-36)	6.64
<b>Frame Insulation 2</b>	NA		NA		FG batt (R-13)	0.85	NA	
<b>Interior Sheathing</b>	NA		NA					
<b>Interior Finish</b>	½-in. GWB	1.94	½-in. GWB	1.94			½-in. GWB	1.94
<b>Total \$/ft<sup>2</sup></b>	8.76		11.55		11.12		13.48	
<b>Nominal R-Value</b>	22		46		35		36	
<b>Total \$/ft<sup>2</sup>/R</b>	0.40		0.25		0.32		0.37	

Notes:

<sup>1</sup> Data from RS Means 2011 for Boston

<sup>2</sup> CFI cost is for loose fill, not dense-pack

<sup>3</sup> SIP cost includes materials + 30% for fabrication. RSMeans data not available for 11.25 in. EPS.

**Table 22. Total and Area Cost for Double Stud High-R Walls<sup>1</sup>**

	Conventional “Code-Built” Wall		Cellulose Insulated Double Stud Wall		Hybrid Insulated Double Stud Wall		Double Stud Wall With ocSPF		11.25 in. EPS SIP Wall	
	Product	Cost	Product	Cost	Product	Cost	Product	Cost	Product	Cost
<b>WRB</b>	Tyvek	0.35	Tyvek	0.35	Tyvek	0.35	Tyvek	0.35	Tyvek	0.35
<b>Exterior Insulation</b>	NA		NA		NA		NA		NA	
<b>Exterior Sheathing</b>	7/16 in. OSB	0.98	7/16 in. OSB	0.98	7/16 in. OSB	0.98	7/16 in. OSB	0.98	11.25 in. SIP <sup>3</sup> 7/16 in. OSB 11.25 in. EPS (R-45) 7/16 in. OSB	11.02
<b>Framing</b>	2 × 6 @ 16 in. o.c.	4.32	2 × 4 @ 16 in. OC outer 2 × 4 @ 24-in. o.c. inner	6.36	2 × 4 @ 16 in. OC outer 2 × 4 @ 24-in. o.c. inner	6.36		6.36		
<b>Frame Insulation 1</b>	FG batt (R-22)	1.17	9.25 in. CFI <sup>2</sup> (R-35)	3.28	2-in. ccSPF (R-10)	1.66	9.5 in. ocSPF	3.94		
<b>Frame Insulation 2</b>	NA		NA		7.25 in. CFI (R-27.5)	2.69	NA			
<b>Interior Sheathing</b>	NA		NA		NA		NA			
<b>Interior Finish</b>	½-in. GWB	1.94	½-in. GWB	1.94	½-in. GWB	1.94	½-in. GWB	1.94	½-in. GWB	1.94
<b>Total \$/ft<sup>2</sup></b>	8.76		12.91		15.64		13.57		13.31	
<b>Nominal R-Value</b>	22		35		37.5		35		45	
<b>Total \$/ft<sup>2</sup>/R</b>	0.40		0.37		0.42		0.39		0.30	

Notes:

<sup>1</sup> Data from RS Means 2011 for Boston

<sup>2</sup> CFI cost is for loose fill, not dense-pack

<sup>3</sup> SIP cost includes materials + 30% for fabrication. RSMeans data not available for 11.25 in. EPS.

Based on the comparisons, all four of the high-R walls cost less than the conventional “code-built” walls when normalized for the nominal R-value. The exterior insulated advance framed wall is more cost competitive than the other high-R walls. It should be noted that the associated unit area costs are susceptible to regional cost variations and availability of the material. The data above represent only a general cost comparison and may be significantly different depending on the region. Region specific cost calculations should be conducted prior to adoption of a high-R wall insulation strategy.

## 4 Recommendations and Conclusions

Modern high R-value walls—walls that are constructed to have a significantly higher than code prescribed thermal performance—are more at risk of moisture-related problems than walls that have a higher thermal conductance and elevated levels of air leakage. There are several factors that contribute to this risk (Lstiburek 2010). First, greater control of heat and air movement reduces the potential for drying to occur. Thus, walls that get wet tend to stay wet for longer and accumulating moisture may exceed the capacity of the wall assembly materials to store or redistribute moisture safely. Second, modern buildings are built using lighter-weight non-absorptive assemblies, which have less potential for safe storage of moisture, and engineered materials, which are often less tolerant to moisture. Additionally, interior and exterior finish layers in modern construction tend to have lower vapor permeance and therefore further restrict potential drying. Buildings constructed this way are more energy efficient, more resource efficient, and typically can be constructed more quickly and at lower cost—but require greater attention to detail when it comes to the control of moisture.

Any construction assembly that is part of the building enclosure must be designed and built to manage the risk of moisture-related damage. Moisture in buildings or in building enclosure elements may degrade building materials, support mold growth, and, of course, may damage the contents enclosed within. Moisture may come from several sources: bulk water intrusion from rain, melting snow, surface runoff, or groundwater; bulk water from interior flooding; moisture in the exterior environment; moisture generated internally by occupants; moisture moving through materials in contact with the ground; and moisture that has been “built-in” to the building during construction. Moisture from all of these sources must be managed to ensure building durability and occupant health.

In this study, hygrothermal simulations were prepared to assess the moisture performance of representative high R-value walls in a range of climate zones and a number of variables affect the risk were examined (climate, cladding type, insulation type and location, etc.). Four research questions were addressed by this project. Each is discussed below.

### 1. What is the role of insulation levels on the risk in different climates?

Increasing amounts of insulation increase the risk of moisture problems in nearly all climate zones. Decreased vapor permeance of the insulation and decreased heat fluxes combine to exacerbate any moisture susceptibilities inherent in the system. However, the location of the insulation is more important than the quantity of insulation. A given amount of insulation installed outboard of the wood sheathing intrinsically grants more moisture resistance to the wall assembly than the equivalent amount in a wall cavity. The elevated sheathing temperature provided by the exterior insulation protects the sheathing from moisture damage by enabling higher rates of evaporation and lower rates of condensation. Cavity insulation hampers drying of the sheathing by keeping it at a lower temperature, developing conditions prone to air leakage condensation and minimized evaporation.

Colder climates require a greater amount of insulation than warmer climates, which makes the location of the insulation even more imperative for the proper functioning and moisture

durability of the wall assembly. Exterior insulation is the best approach for insulating buildings in cold climates.

## **2. How resistant are the walls to air leakage and vapor diffusion in different climates?**

Two wall types, exemplifying the exterior insulation versus cavity insulation strategy, were simulated in four climates to assess the limits of vapor diffusion and air leakage. The two wall types were selected to represent a moisture-tolerant (advance framed wall with 4 in. of exterior insulation) and a moisture-sensitive assembly (double stud wall with 9.5 in. of CFI). The tested walls all perform well in ideal circumstances (i.e., no imposed sources of moisture) in all climates, with the exception of extremely high MCs in very cold climates (i.e., 40% indoor RH in International Falls). In following the building code requirements, vapor diffusion is not an issue for any of the walls. However, air leakage—which is an assembly property and varies by construction—leads to air leakage condensation and deposits an order of magnitude more water than vapor diffusion while bypassing the vapor retarding layers. Further, vapor retarding layers also inhibit drying in one direction, and in hot and humid climate, generate significant condensation from moisture-laden outdoor air infiltrating into the wall assembly.

Air leakage condensation occurs only if the sheathing temperature falls below the indoor air dew point temperature and if air contacts the sheathing. Only the exterior insulated wall assembly effectively manages air leakage condensation. The advance framed wall mitigates air leakage condensation by keeping the sheathing temperature closer to indoor temperatures.

The most resistant walls to air leakage and vapor diffusion are exterior insulated walls, or walls with cavity insulation that behave as exterior insulation (i.e., ccSPF insulation eliminating connectivity of the exfiltrating indoor air with the cold sheathing), while maintaining interior RHs to adequate levels given the local climate (typically, < 30% RH in cold climates, and 40% in temperature climates).

## **3. What are the drying rate capacities of the proposed wall assemblies?**

To simulate the drying rate capacities of the walls, the simulations started with the sheathing set to the fiber saturation point (28% MC). The simulations started on October 1 and were left to run for an entire year.

The most important aspect learned from the simulations is that the drying capacities of the walls are highly dependent on the outdoor environment. A wall with a wet and cool climate will not be able to dry as fast as the equivalent wall in a warm and dry climate. The second key finding is that walls that incorporate vapor-impermeable membranes generally dry out slower than those without. This is a result of throttling or elimination of the wall's capacity to dry out to either the interior or the exterior.

Overall, the advance framed wall dries at a faster rate than the other remaining walls, provided that no greater than a Class III vapor retarder is used. The double stud wall with cellulose decreases the MC of the OSB at the expense of elevated MC of the cellulose. Effectively, the moisture is redistributed within the wall only and does not actually dry. The cellulose acts as a sink for both construction moisture and bulk water leakage. The additional moisture is trapped within the system when polyethylene is used. This may be a potential source of moisture damage

to the double stud walls. The sheathing in both the SIP wall and the double stud wall with ccSPF can dry only to the exterior. Consequently, the drying capacities are dependent on the permeance of the WRB and the climate.

#### **4. What are the high-level steps necessary to build moisture-resistant high-R wall assemblies?**

There are few challenges to building high-R walls that are moisture durable. Much of the information is publicly available on a range of websites and publications. Further, the IRC enables designers, builders, and architects to design and build wall assemblies that possess high thermal resistance and are moisture resistant.

The biggest problem facing high-R wall assemblies is the initial capital investment required. In many areas, the least expensive option that complies with the building code will be used. Further, high-R walls are only especially beneficial in colder climates where heating costs are high and the risk of occupant discomfort is considerable. High-R walls are frequently seen only in custom homes where the owner desires high levels of thermal resistance. There are no significant barriers on making these walls moisture tolerant aside from proper design, detailing, and construction in adherence with the code and any manufacturer's instructions.

#### **4.1 Future Considerations**

Looking forward, more of this type of analysis needs to be done on other approaches to high R-value walls. However the models need to be verified empirically. To validate the models, empirical research on small- and full-scale assembly mockups and buildings, with monitored boundary conditions and instrumented with temperature and moisture sensors, needs to be undertaken to examine and fully quantify these risks.

The analysis conducted for this report did not include extremely high R-value products, such as vacuum insulated panels, or aerogels. These materials are considered to be cost prohibitive for most projects and not accessible to typical developers and builders, but this may not be the case in the future. As a general comment, moisture control for new systems and new materials should be carefully considered—particularly when little practical field experience exists.

## References

ASHRAE (2009). 2009 ASHRAE Standard 160—Criteria for Moisture Control Design Analysis in Buildings. American Society of Heating, Refrigerating, and Air Conditioning Engineers, Inc.

Ayerst, G. (1968) *The Effects of Moisture and Temperature on Growth and Spore Germination in some Fungi*, Journal of Stored Products. 1969, Vol5, pp. 127-141. Pergamon Press, Great Britain

Broniek, J., K. Brozyna, and D. Stecher. (2010). Evaluating R40 Above Grade Walls for a Production Built Zero Energy House. Proceedings of Thermal Performance of Exterior Envelopes of Whole Buildings XI, Portland, USA.

BSC. (2010a). “Designs that Work - Cold Climate: Habitat for Humanity High R-Value Prototype.” Building Science Corporation, Somerville, Massachusetts. <http://www.buildingscience.com/documents/case-studies/cs-ma-westford-hfh/>. Accessed January 3, 2011.

BSC. (2010b). “RR-1004: 2010 Community Scale Evaluations.” Building Science Corporation, Somerville, Massachusetts. <https://www.buildingscience.com/documents/ba-2010-annual-report-files/rr-1004-2010-community-scale-evaluations/>. Accessed January 3, 2011.

Dickerhoff, D.J., Grimsrud, D.T., Lipschutz, R.D. (1982). Component leakage testing in residential buildings. *Proceedings of the American Council for an Energy-Efficient Economy, 1982 Summer Study*, Santa Cruz,, CA. Report LBL 14735. Lawrence Berkeley National Laboratory, Berkeley, CA.

Forest Products Laboratories. (1999) *Wood as an Engineering Material*, USDA Forest Services, Algrove Publishing, Wisconsin

Harrje, D., Born, G. (1982), Cataloguing air leakage components in houses, *Proceedings of the ACEEE 1982 Summer Study*, Santa Cruz, CA. American Council for an Energy-Efficient Economy, Washington, D.C.

Hutcheon, N., Handegoord, G., (1983) *Building Science for a Cold Climate*, NRC-CNRC, Ottawa, ON.

IECC. (2012). International Energy Conservation Code. International Code Council, Washington, DC.

Kramer, M., Karagiozis, A. (2004) *A New Look at Residential Interior Environmental Loads*, ASHRAE

Künzel, H. (2002). WUFI PC-Program for calculating the coupled heat and moisture transfer in buildings. Fraunhofer Institute for Building Physics. Holzkirchen, Germany.

Latta, J.K., (1973). Walls, Windows and Roofs for the Canadian Climate, STP No. 1 Division of Building Research, NRC-CNRC, Ottawa, ON

- Lstiburek, J., (2006) *Water Management Guide*, Building Science Press, Westford, MA.
- Lstiburek, J. (2009). BSI-018: Westford House. Building Science Corporation, Somerville, Massachusetts. <http://www.buildingscience.com/documents/insights/bsi-018-westford-house>. Accessed November 13, 2012.
- Lstiburek, J.W. (2010). “Building Sciences: Don't Be Dense with Insulation” *ASHRAE Journal* (vol. 52); pp. 54-57.
- Lukachko, A. and D. Bergey. (2010). “Wyandotte NSP2’ Cold Climate Commercially Viable Energy Efficiency Solution Package” Building Science Corporation, Somerville, Massachusetts. Forthcoming publication - NREL.
- Lukachko, A. and A. Grin. (2011). “4.3.3 Wyandotte NSP2 Final Technical Report” Building Science Corporation, Somerville, Massachusetts. Forthcoming publication - NREL.
- Lukachko, A., C. Gates, and J. Straube. (2011). “3.1.2 Final Advanced New Construction Measure and/or Strategy Guideline”. Forthcoming publication—NREL.
- Lukachko, A., A. Grin, and D. Bergey. (2012). “Michigan NSP2—Draft Report” Building Science Corporation, Somerville, Massachusetts. Forthcoming publication - NREL.
- Quirouette, R.L., (1985) *The Difference Between a Vapour Barrier and an Air Barrier*, Building Practice Note No. 54, NRC-IRC, Ottawa, ON
- Rose, W. (2005). *Water in Buildings: An Architect’s Guide to Moisture and Mold*. John Wiley & Sons, New Jersey.
- Sedlbauer, K. (2004). *Predication of mould fungus formation on the surface of and inside building components*, PhD Thesis. Munich, Germany: Fraunhofer Institute for Building Physics
- Sherman, M.H., Grimsrud, D.T. (1980), *Measurement of Infiltration using Fan Pressurization and Weather Data*, First Symposium of the Air Infiltration Center on Instrumentation and Measurement Techniques, Window, England
- Straube, J., Burnett, E., (2005) *Building Science for Building Enclosures*, Building Science Press, Westford, MA
- Straube, J. and J. Smegal (2009a). Research Report 0903—Building America Special Research Project: High-R Wall Case Study Analysis. Building Science Corporation, Somerville, MA. <http://www.buildingscience.com/documents/reports/rr-0903-building-america-special-research-project-high-r-walls>. Accessed November 14, 2012.
- Straube, J. and J. Smegal (2009b). Research Report 0905—Modeled and Measured Drainage, Storage, and Drying Behind Cladding Systems. Building Science Corporation, Somerville, MA. <http://www.buildingscience.com/documents/reports/rr-0905-modeled-measured-drainage-thermal-x>. Accessed November 14, 2012.



Straube, J. and A. Grin. (2010) Research Report 1006—Building America Special Research Project: High-R Roofs Case Study Analysis.  
<http://www.buildingscience.com/documents/reports/rr-1005-building-america-high-r-value-high-performance-residential-buildings-all-climate-zones/>. Accessed January 30, 2013.

Straube, J. and Smegal, J. (2010). Research Report 1003—Building America Special Research Project: High-R Foundations Case Study. Building Science Corporation, Somerville, MA.  
<http://www.buildingscience.com/documents/reports/rr-1003-building-america-high-r-foundations-case-study-analysis>. Accessed November 14, 2012. Straube, J. (2010) Research Report 1005 - Building America Special Research Project: High R-Value Enclosures for High Performance Residential Buildings in All Climate Zones. Building Science Corporation, Somerville, MA. <http://www.buildingscience.com/documents/reports/rr-1005-building-america-high-r-value-high-performance-residential-buildings-all-climate-zones/>. Accessed January 30, 2013.

Ueno, K., D. Bergey, and H. Wytrykowska. (2012). “4.1.2 Transformations, Inc. Draft Technical Report”. Forthcoming publication—NREL.

Viitanen, H., Bjurman, J. (1995) Mould growth on wood under fluctuating humidity conditions. *Mat und Org.* 29(1):27-46

Viitanen, H., Salonvaara, M. (2001) Failure Criteria. *Moisture Analysis and Condensation Control in Building Envelopes*, ASTM MNL40, pp. 66-80.

Viitanen, H., Ritschkoff, A.C., Ojanen, T., Salonvaara, M. (2003) Moisture conditions and biodeterioration risk of building materials and structure. *Proceedings of the Second International Symposium Integrated Lifetime Engineering of Buildings and Civil Infrastructures, Kuopio, December 1-3*, pp. 151-56

Wang, J., Clark, J., Symons, P., Morris, P. (2012) *Time to Initiation of Decay in Plywood, OSB, and Solid Wood Under Critical Moisture Conditions*, ICBEST June 2012 conference

Wilson, A.J., (1961) “Air Leakage in Buildings”, *Canadian Building Digest 23*, NRC-IRC, Ottawa, ON

## **Appendix A: Representative Detail Drawings**

The following water management detail drawings are included in this appendix.

### **Exterior Insulation Approach** (e.g., Insulating Sheathing over Advanced Framing)

- IS-1 Above Grade Wall to Roof
- IS-2 Foundation Wall to Above Grade Wall
- IS-3 Window Head Detail
- IS-4 Window Sill Detail
- IS-5 Window Jamb Detail
- IS-6 Window Sequence
- IS-7 Window Sequence
- IS-8 Mechanical Penetration
- IS-9 Mechanical Penetration Sequence

### **Interior Insulation Approach** (e.g., Double Stud Wall)

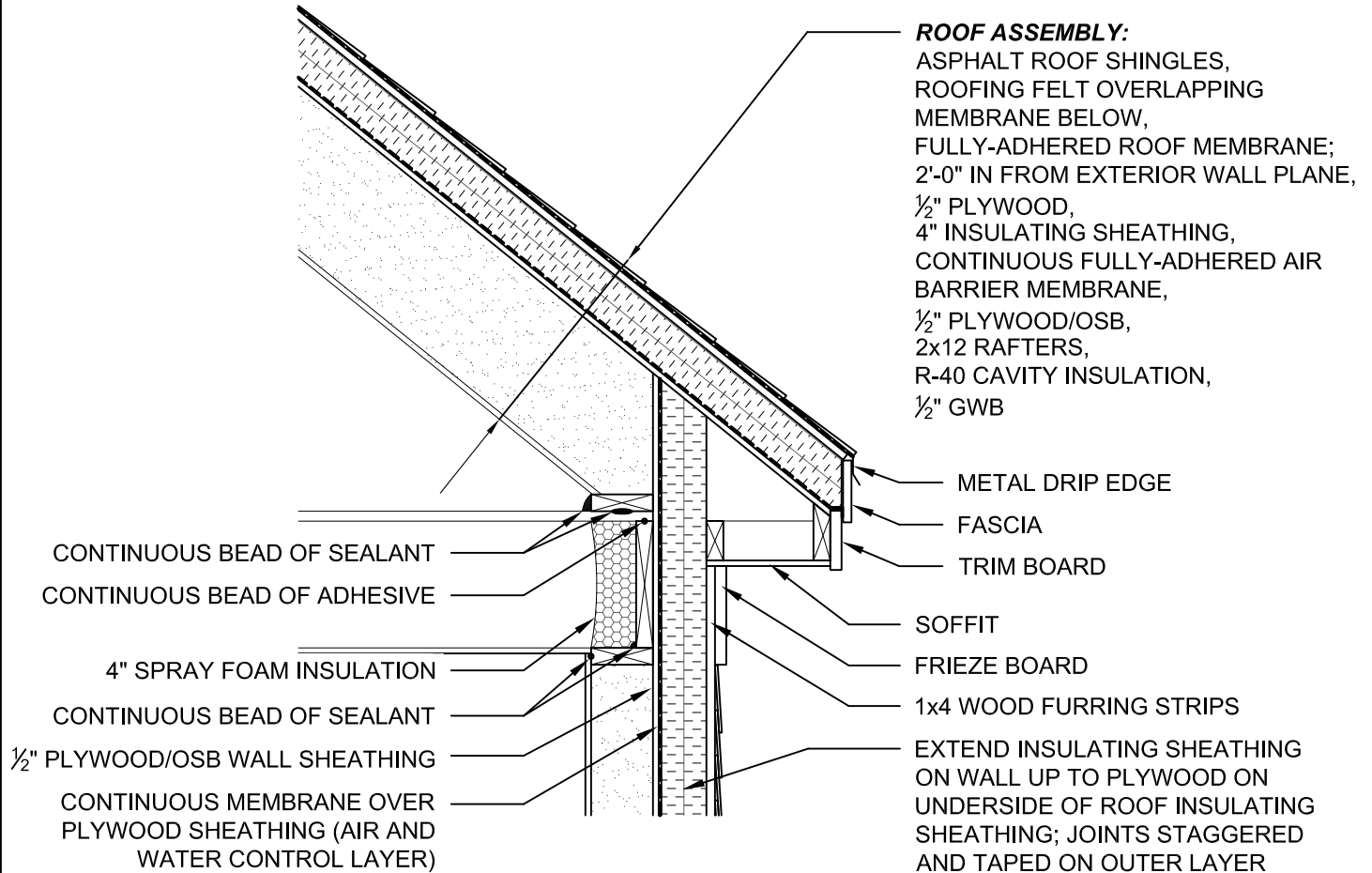
- DSW-1 Above Grade Wall to Roof
- DSW-2 Foundation Wall to Above Grade Wall
- DSW-3 Window Head Detail
- DSW-4 Window Sill Detail
- DSW-5 Window Jamb Detail
- DSW-6 Mechanical Penetration

### **Concrete Masonry Unit Approach**

- CMU-1 Above Grade Wall to Roof
- CMU-2 Foundation Wall to Above Grade Wall

### **Structural Insulated Panel Approach**

- SIPS-1a Above Grade Wall to Roof
- SIPS-1b Above Grade Wall to Roof
- SIPS-2 Foundation wall to Above Grade Wall



## ABOVE GRADE WALL TO ROOF

SCALE: 3/4" = 1'-0"



with

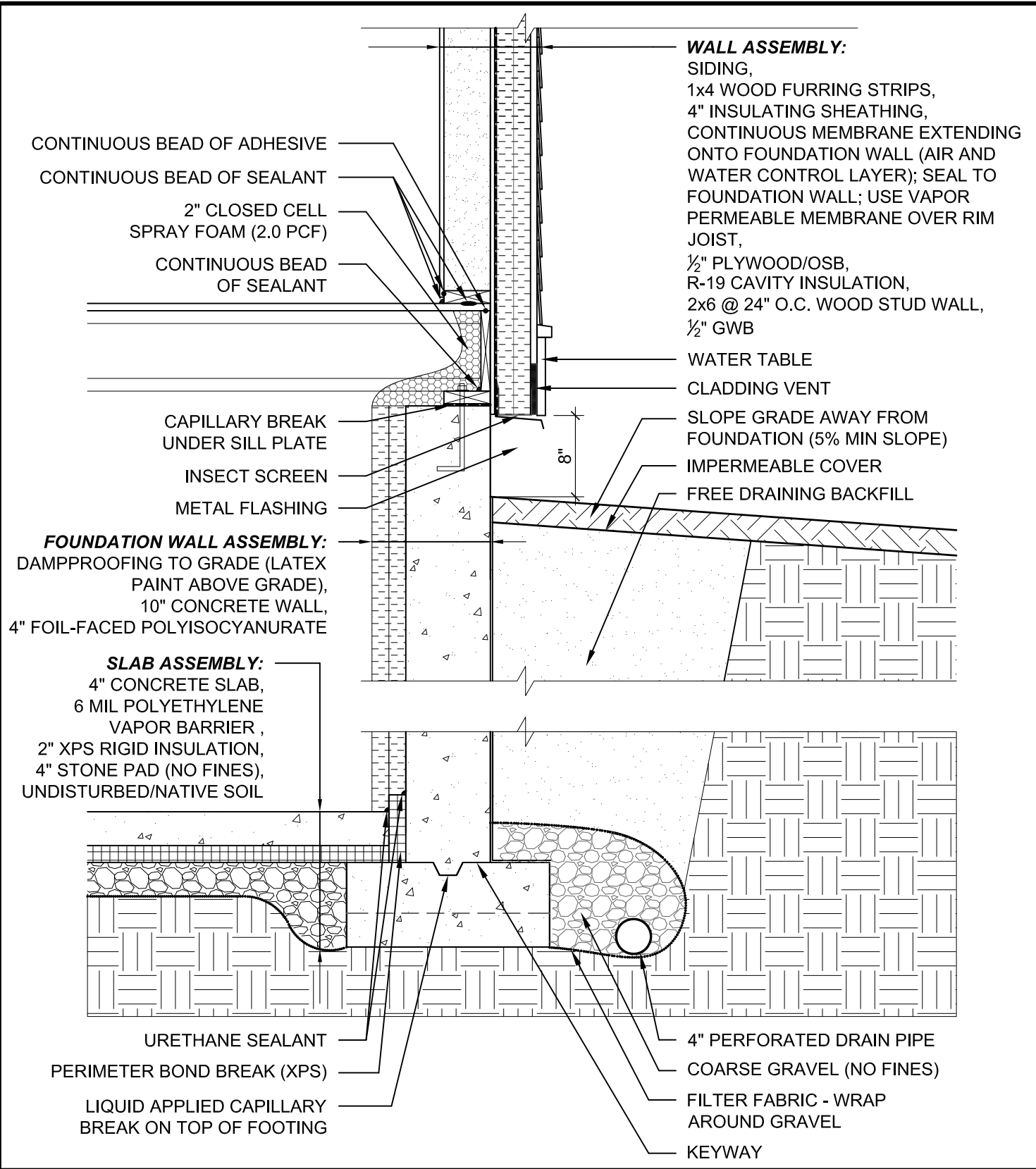


Water Management Details  
 Insulating Sheathing on  
 Advanced Framed Wall

Date: 2013-06-07

Sheet Title:

IS-1



# FOUNDATION WALL TO ABOVE GRADE WALL

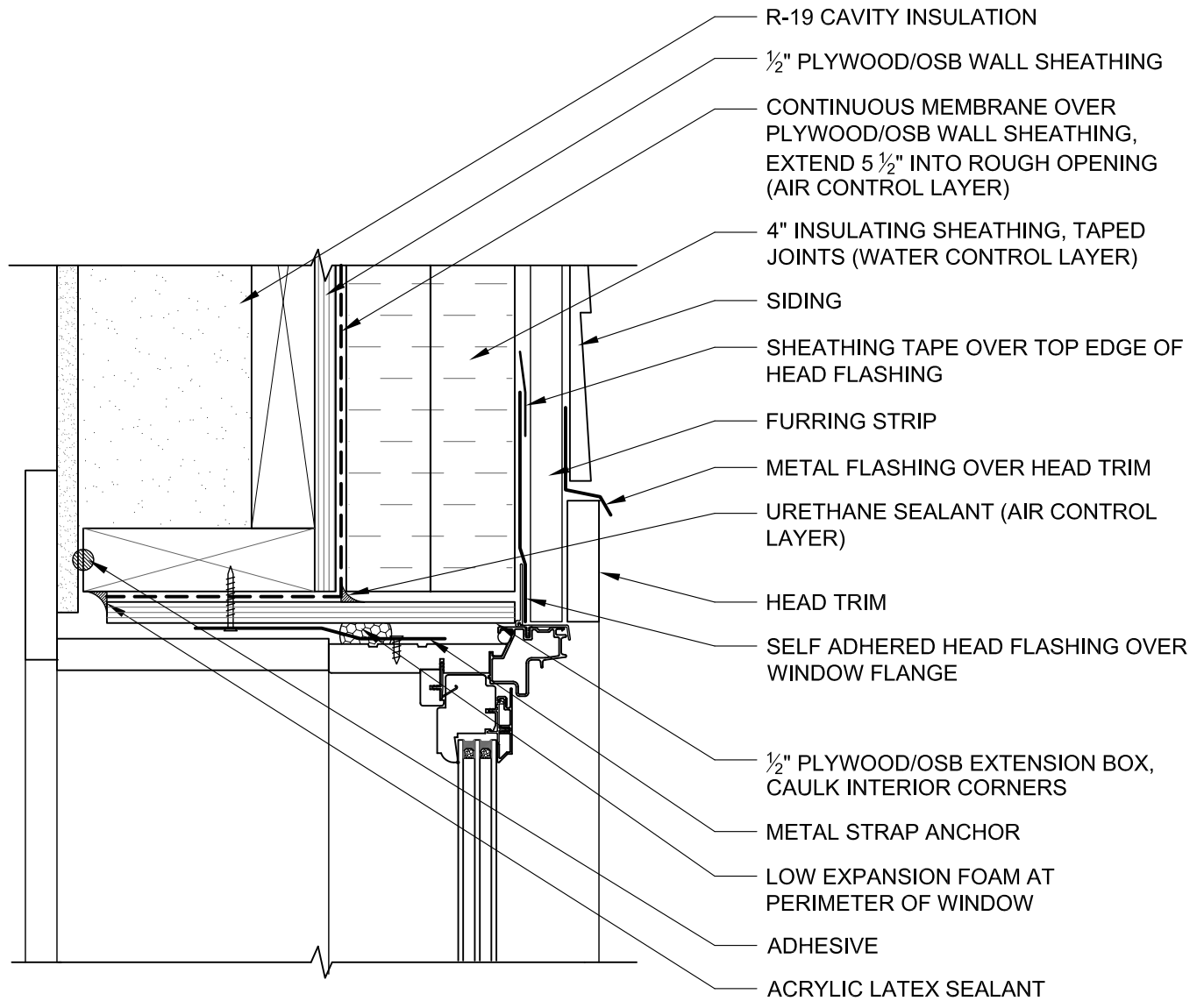
SCALE: 3/4" = 1'-0"



Water Management Details  
 Insulating Sheathing on  
 Advanced Framed Wall  
 Date: 2013-06-07

Sheet Title:

IS-2



## WINDOW HEAD DETAIL

SCALE: 3" = 1'-0"



with

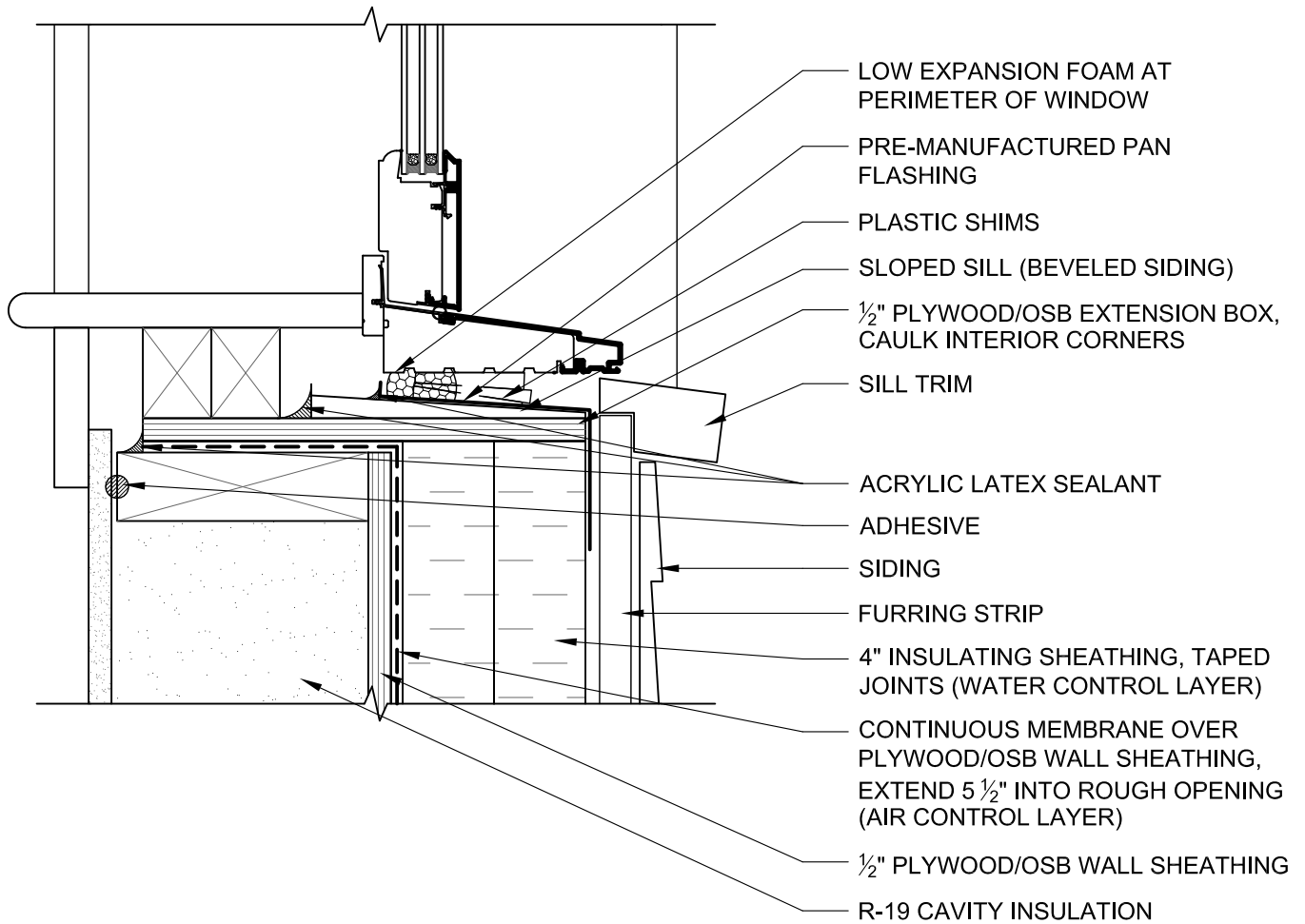


Water Management Details  
 Insulating Sheathing on  
 Advanced Framed Wall

Date: 2013-06-07

Sheet Title:

IS-3



## WINDOW SILL DETAIL

SCALE: 3" = 1'-0"



with

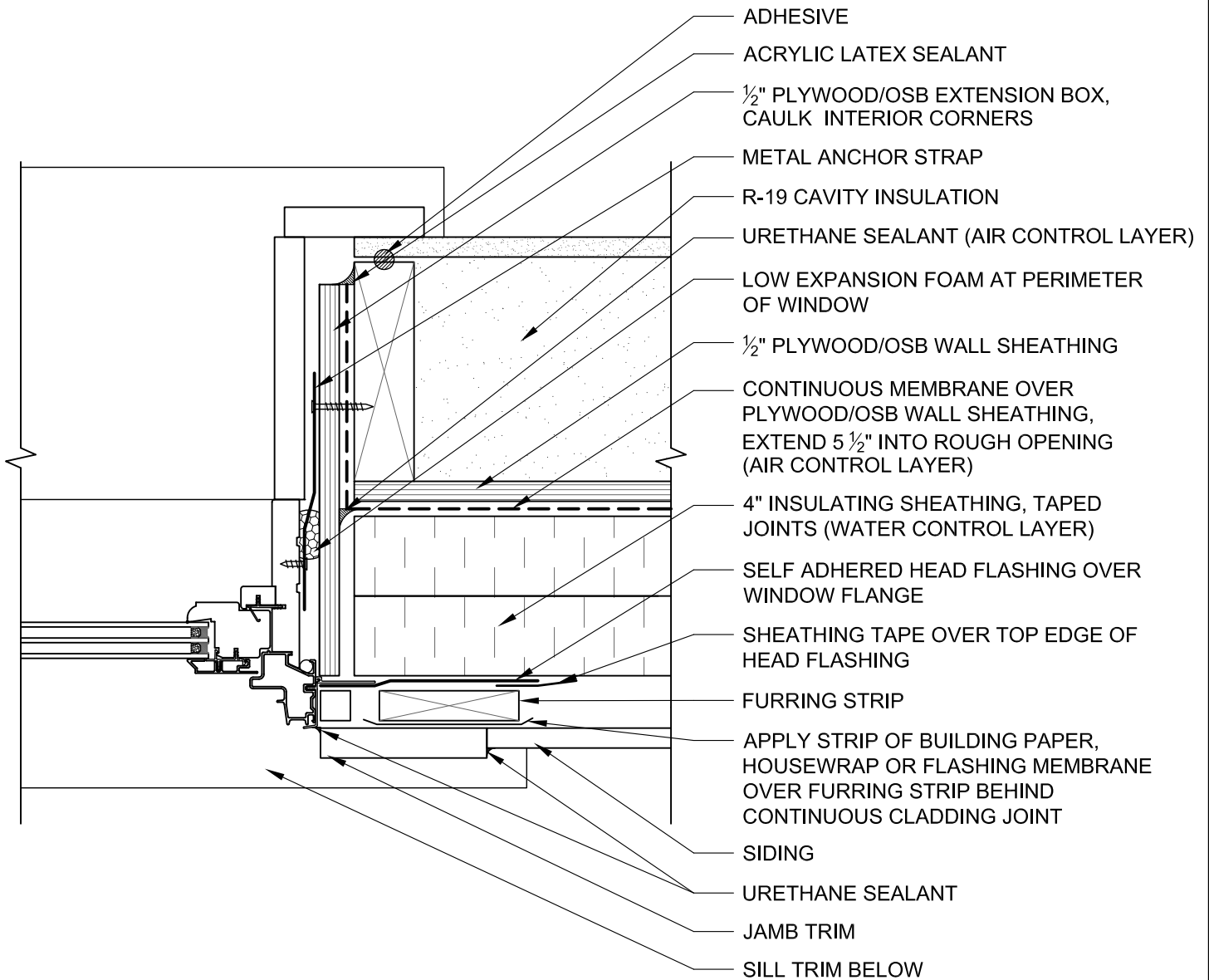


Water Management Details  
 Insulating Sheathing on  
 Advanced Framed Wall

Date: 2013-06-07

Sheet Title:

IS-4



## WINDOW JAMB DETAIL

SCALE: 3" = 1'-0"



with

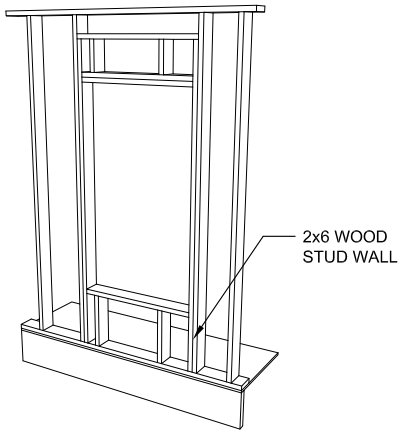


Water Management Details  
Insulating Sheathing on  
Advanced Framed Wall

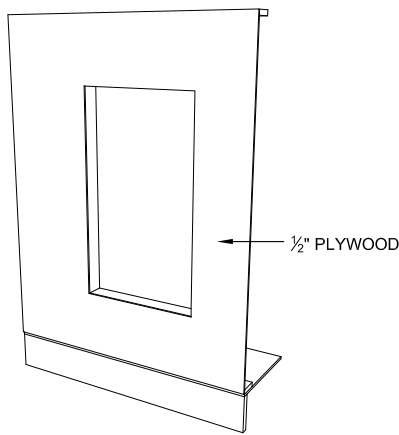
Date: 2013-06-07

Sheet Title:

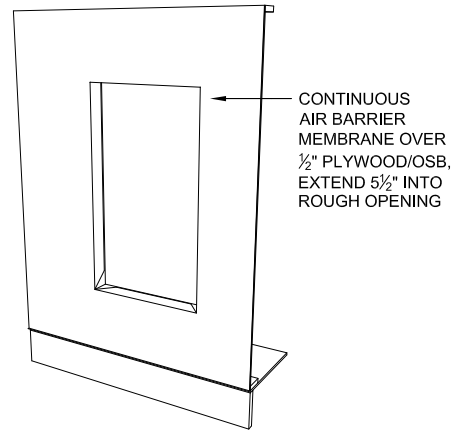
IS-5



2x6 WOOD STUD WALL



1/2" PLYWOOD

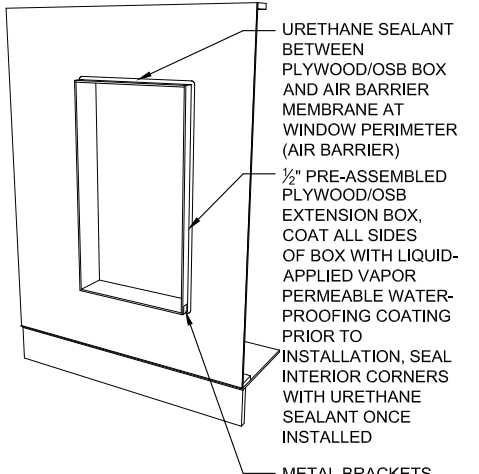


CONTINUOUS AIR BARRIER MEMBRANE OVER 1/2" PLYWOOD/OSB, EXTEND 5/8" INTO ROUGH OPENING

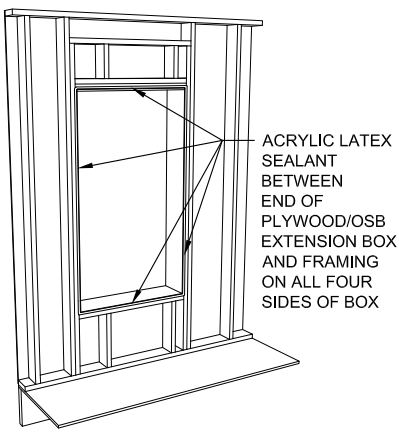
STEP 1

STEP 2

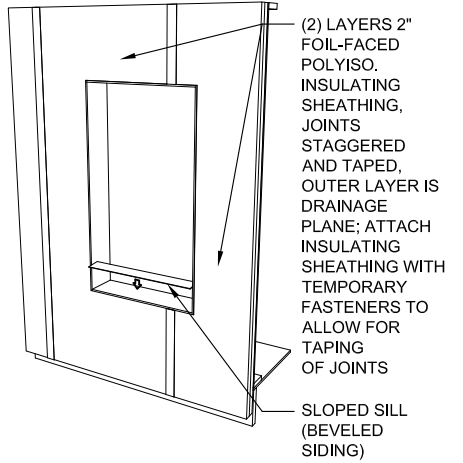
STEP 3



URETHANE SEALANT BETWEEN PLYWOOD/OSB BOX AND AIR BARRIER MEMBRANE AT WINDOW PERIMETER (AIR BARRIER)  
1/2" PRE-ASSEMBLED PLYWOOD/OSB EXTENSION BOX, COAT ALL SIDES OF BOX WITH LIQUID-APPLIED VAPOR PERMEABLE WATER-PROOFING COATING PRIOR TO INSTALLATION, SEAL INTERIOR CORNERS WITH URETHANE SEALANT ONCE INSTALLED



ACRYLIC LATEX SEALANT BETWEEN END OF PLYWOOD/OSB EXTENSION BOX AND FRAMING ON ALL FOUR SIDES OF BOX

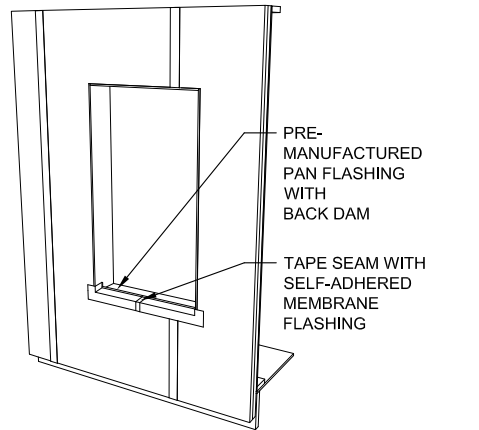


(2) LAYERS 2" FOIL-FACED POLYISO. INSULATING SHEATHING, JOINTS STAGGERED AND TAPED. OUTER LAYER IS DRAINAGE PLANE; ATTACH INSULATING SHEATHING WITH TEMPORARY FASTENERS TO ALLOW FOR TAPING OF JOINTS  
SLOPED SILL (BEVELED SIDING)

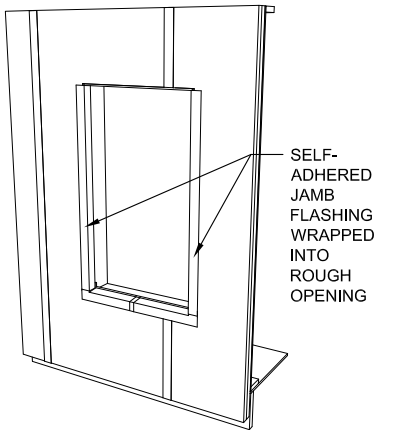
STEP 4

STEP 5 (INTERIOR VIEW)

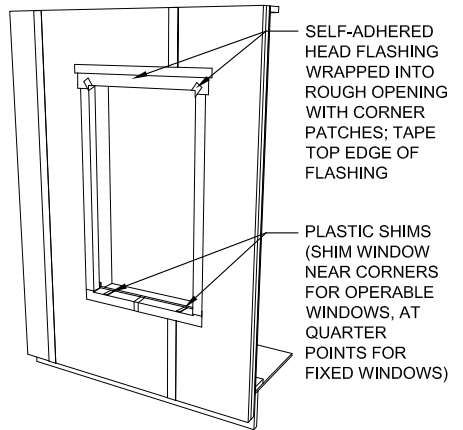
STEP 6



PRE-MANUFACTURED PAN FLASHING WITH BACK DAM  
TAPE SEAM WITH SELF-ADHERED MEMBRANE FLASHING



SELF-ADHERED JAMB FLASHING WRAPPED INTO ROUGH OPENING



SELF-ADHERED HEAD FLASHING WRAPPED INTO ROUGH OPENING WITH CORNER PATCHES; TAPE TOP EDGE OF FLASHING  
PLASTIC SHIMS (SHIM WINDOW NEAR CORNERS FOR OPERABLE WINDOWS, AT QUARTER POINTS FOR FIXED WINDOWS)

STEP 7

STEP 8

STEP 9

# WINDOW SEQUENCE

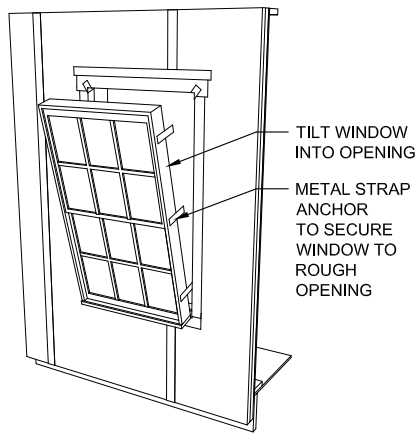
SCALE: N.T.S.



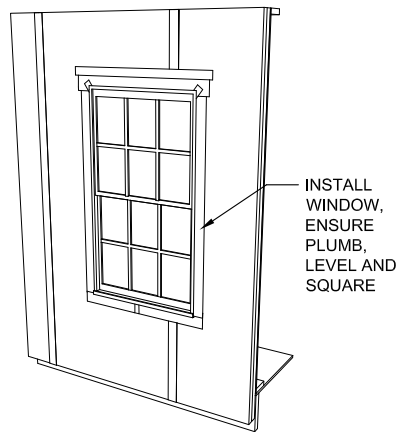
Water Management Details  
Insulating Sheathing on  
Advanced Framed Wall  
Date: 2013-06-07

Sheet Title:  
**IS-6**

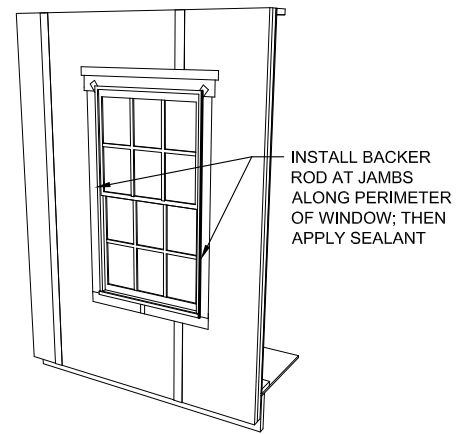




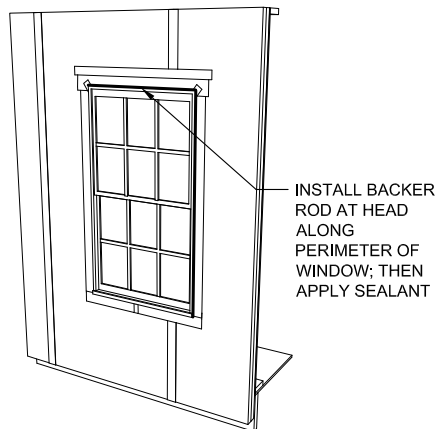
STEP 10



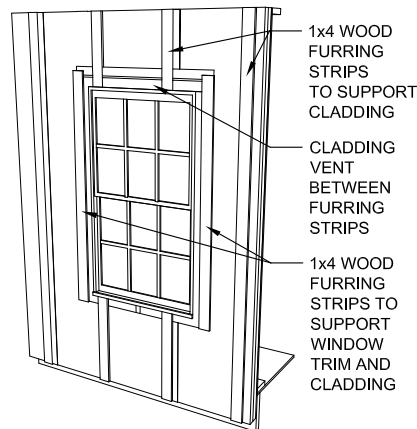
STEP 11



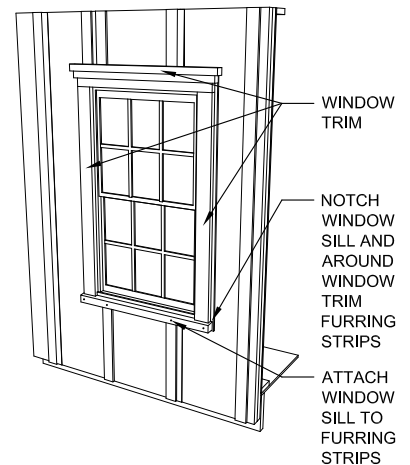
STEP 12



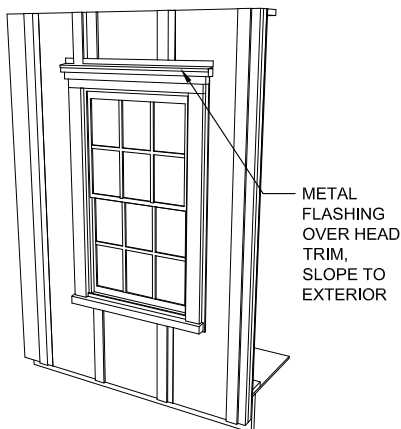
STEP 13



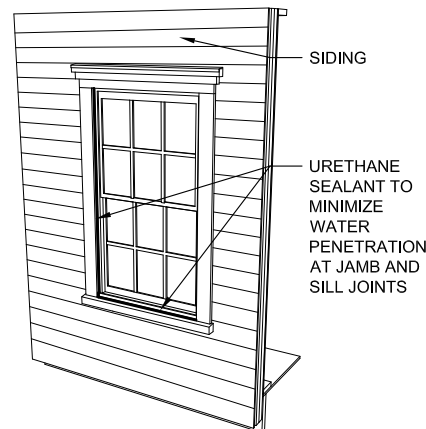
STEP 14



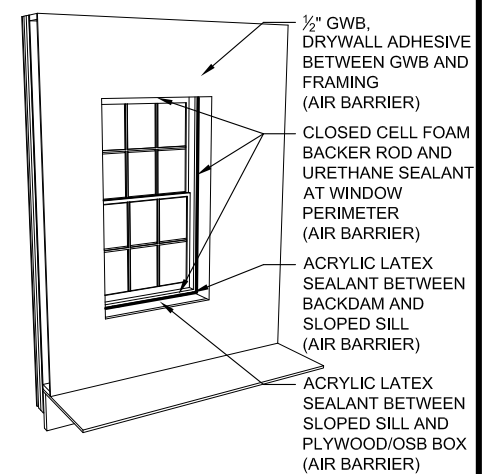
STEP 15



STEP 16



STEP 17



STEP 18  
(INTERIOR VIEW)

# WINDOW SEQUENCE

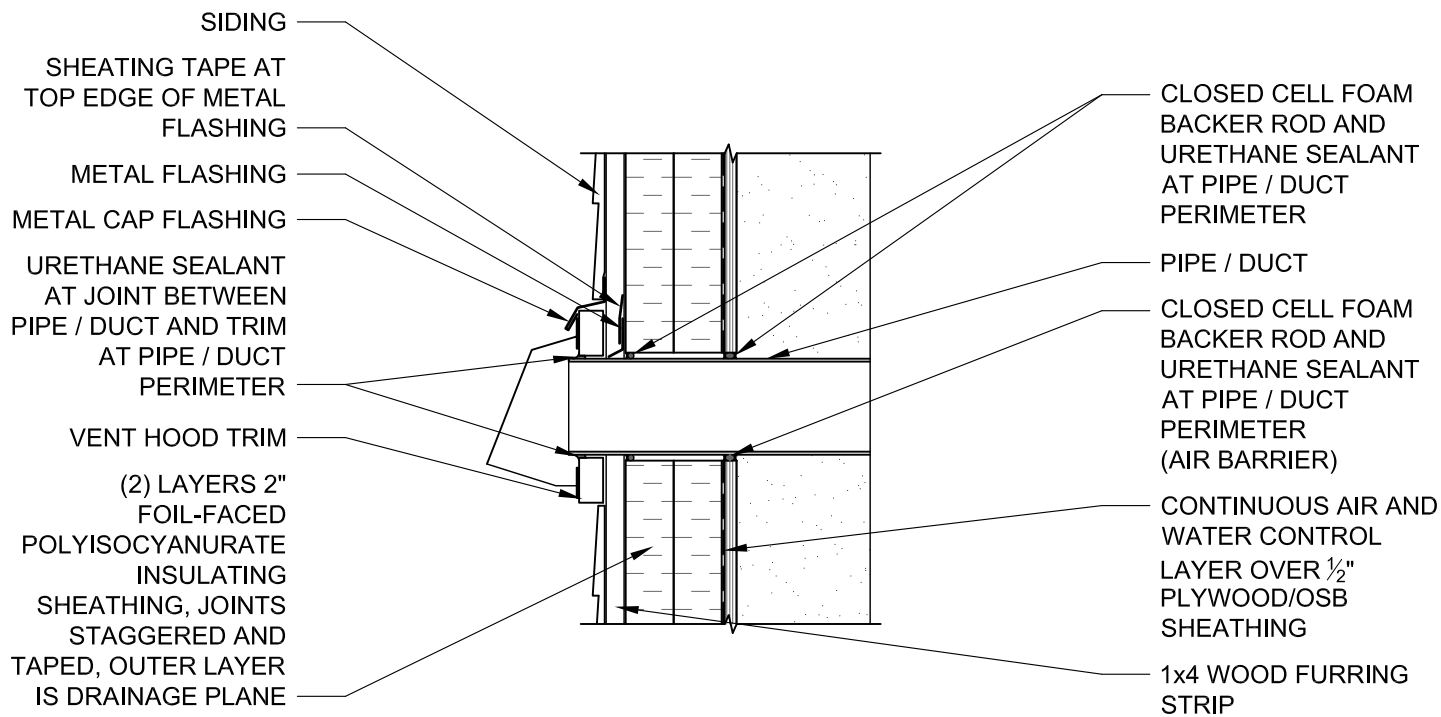
SCALE: N.T.S.



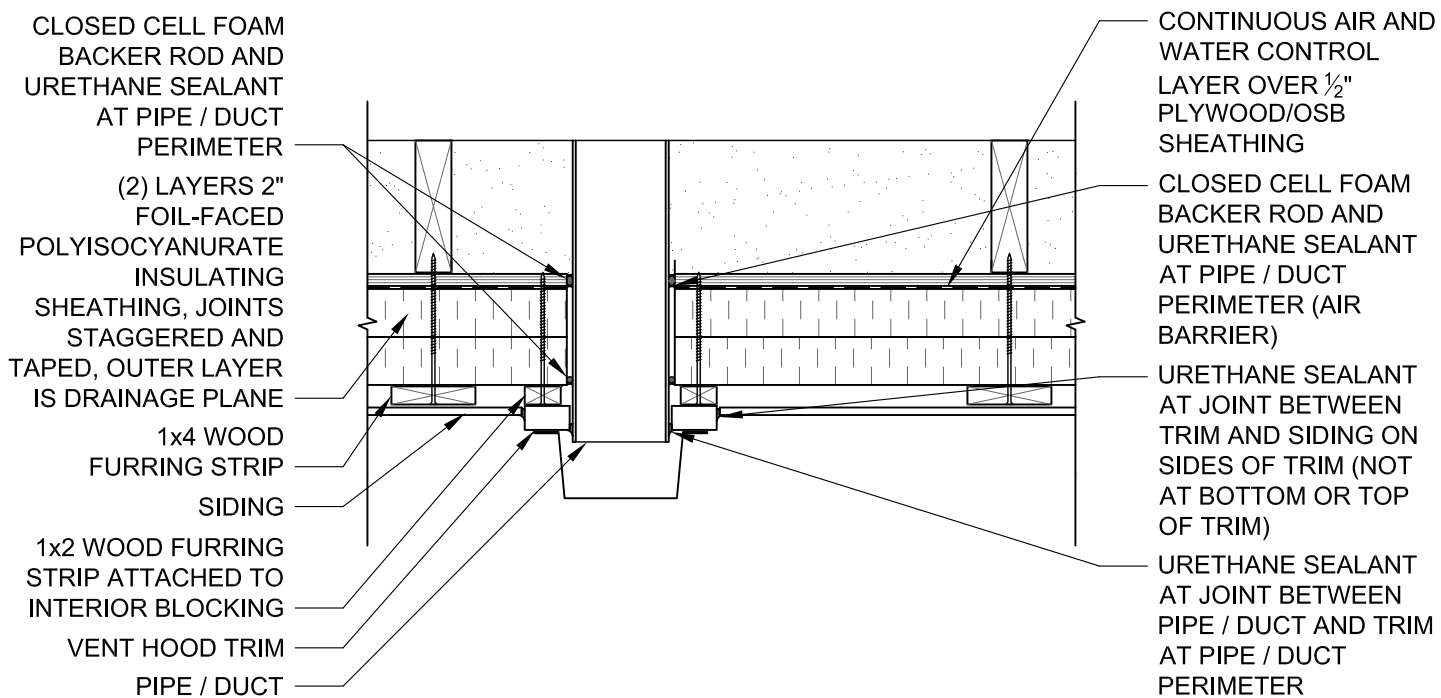
Water Management Details  
Insulating Sheathing on  
Advanced Framed Wall  
Date: 2013-06-07

Sheet Title:

IS-7



SECTION



PLAN

# MECHANICAL PENETRATION

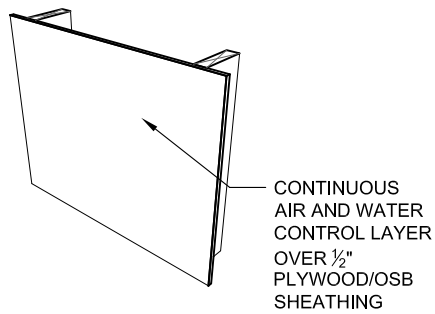
SCALE: 1 1/2" = 1'-0"



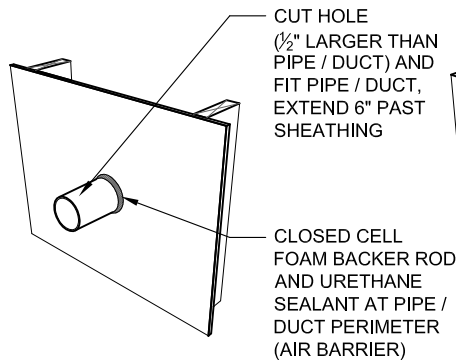
Water Management Details  
 Insulating Sheathing on  
 Advanced Framed Wall  
 Date: 2013-06-07

Sheet Title:

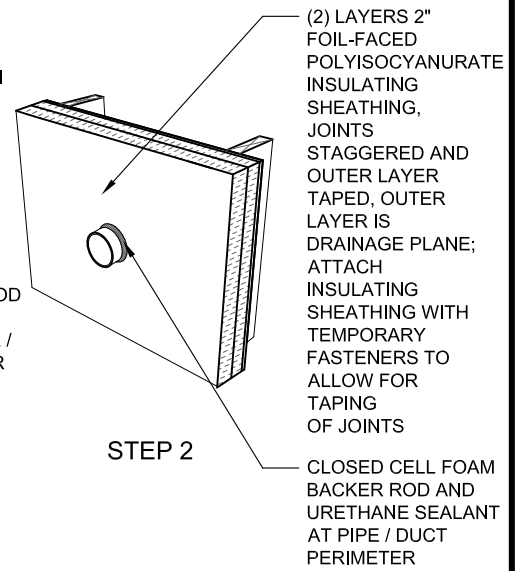
IS-8



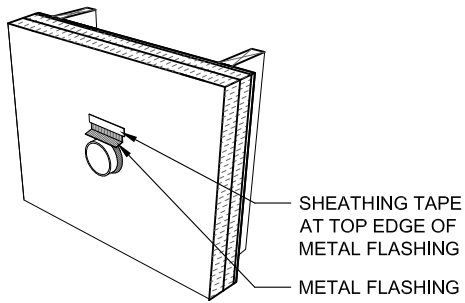
STARTING POINT:  
EXTERIOR WALL WITH  
AIR BARRIER MEMBRANE



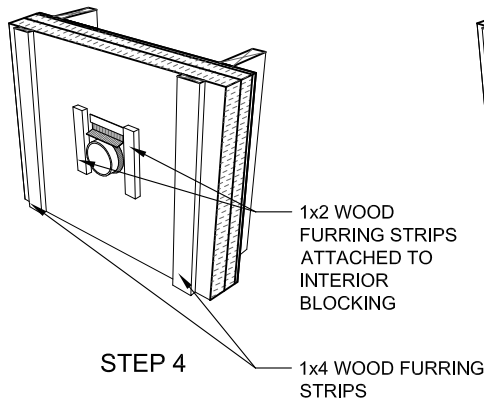
STEP 1



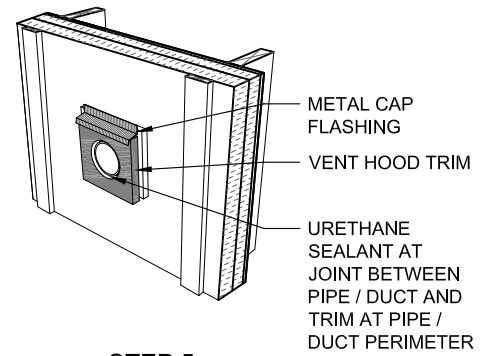
STEP 2



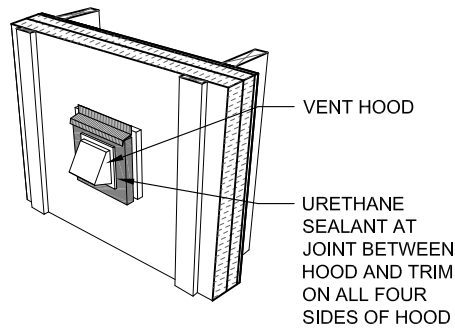
STEP 3



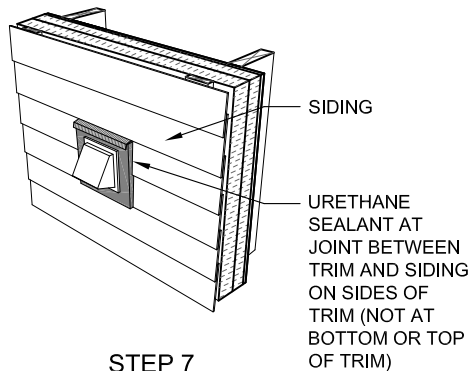
STEP 4



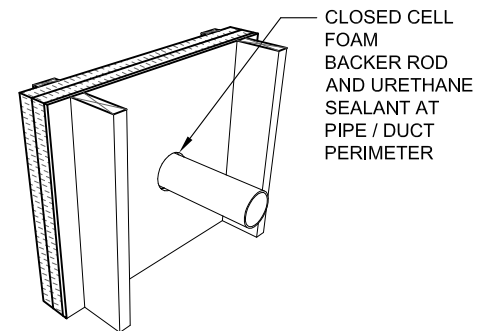
STEP 5



STEP 6



STEP 7



STEP 8

## MECHANICAL PENETRATION SEQUENCE

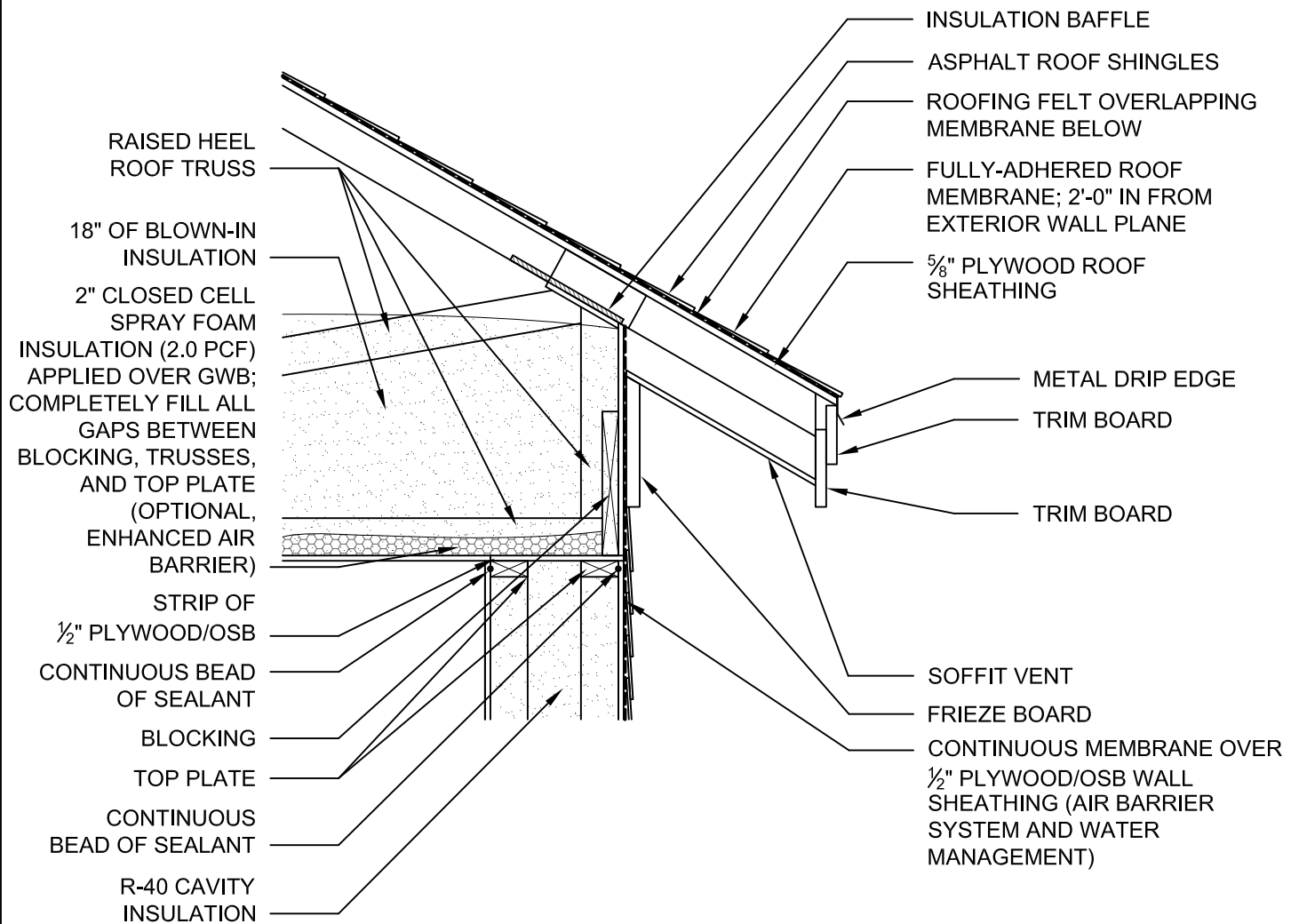
SCALE: N.T.S.



Water Management Details  
Insulating Sheathing on  
Advanced Framed Wall  
Date: 2013-06-07

Sheet Title:

IS-9



## ABOVE GRADE WALL TO ROOF

SCALE: 3/4" = 1'-0"



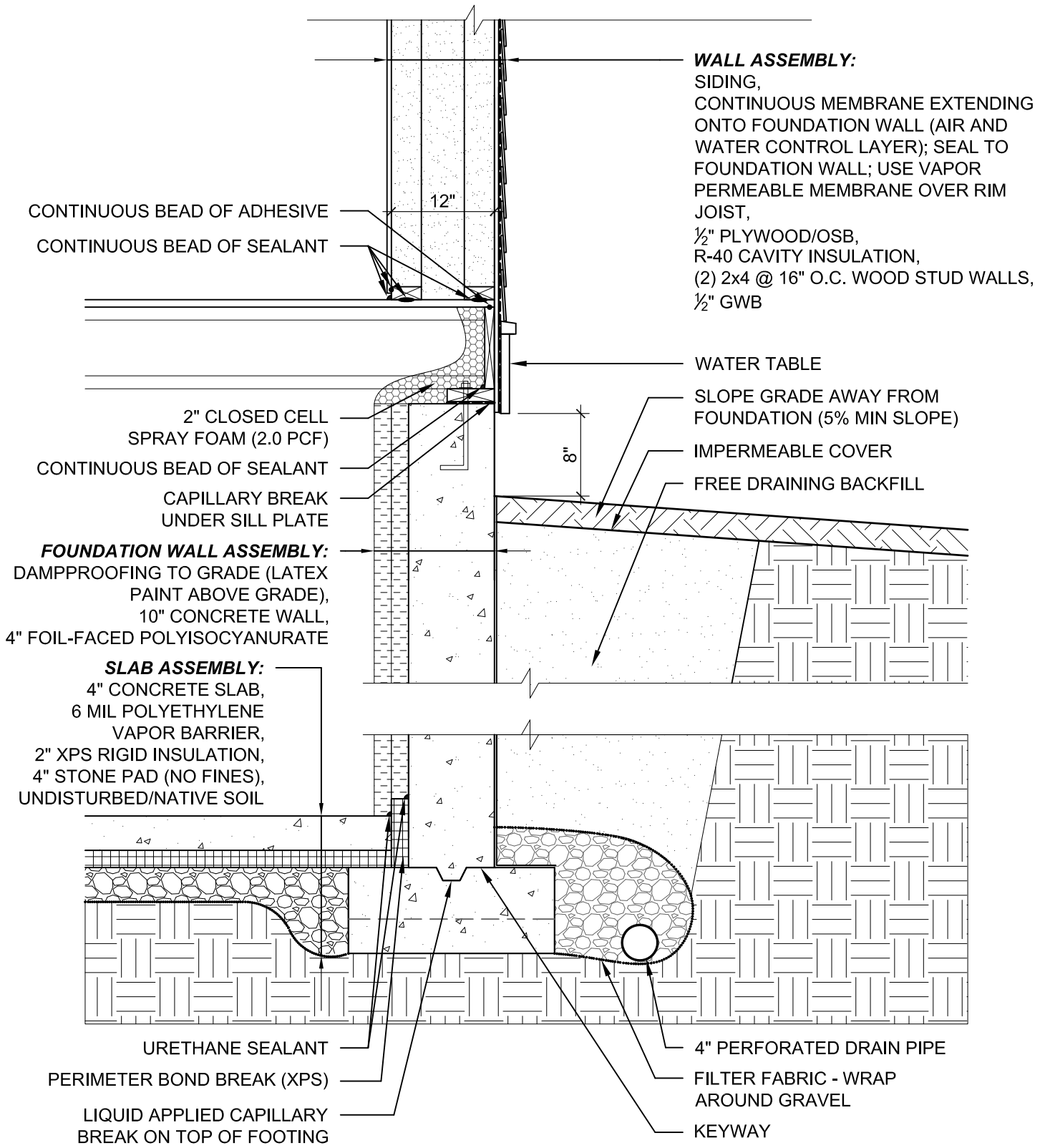
with



Water Management Details  
 Double Stud Wall  
 Date: 2013-06-07

Sheet Title:

**DSW-1**



# FOUNDATION WALL TO ABOVE GRADE WALL

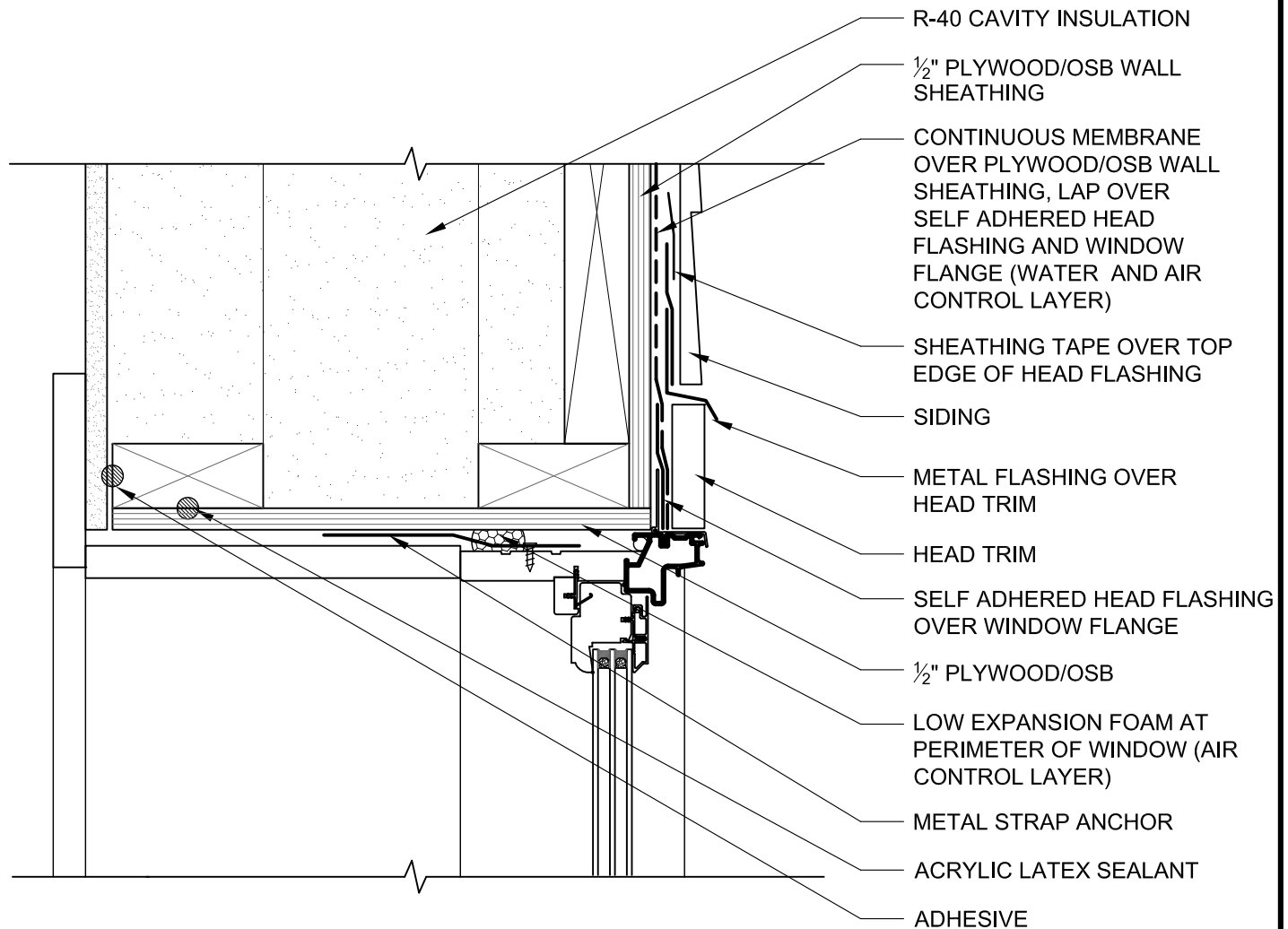
SCALE: 3/4" = 1'-0"



Water Management Details  
 Double Stud Wall  
 Date: 2013-06-07

Sheet Title:

**DSW-2**



# WINDOW HEAD DETAIL

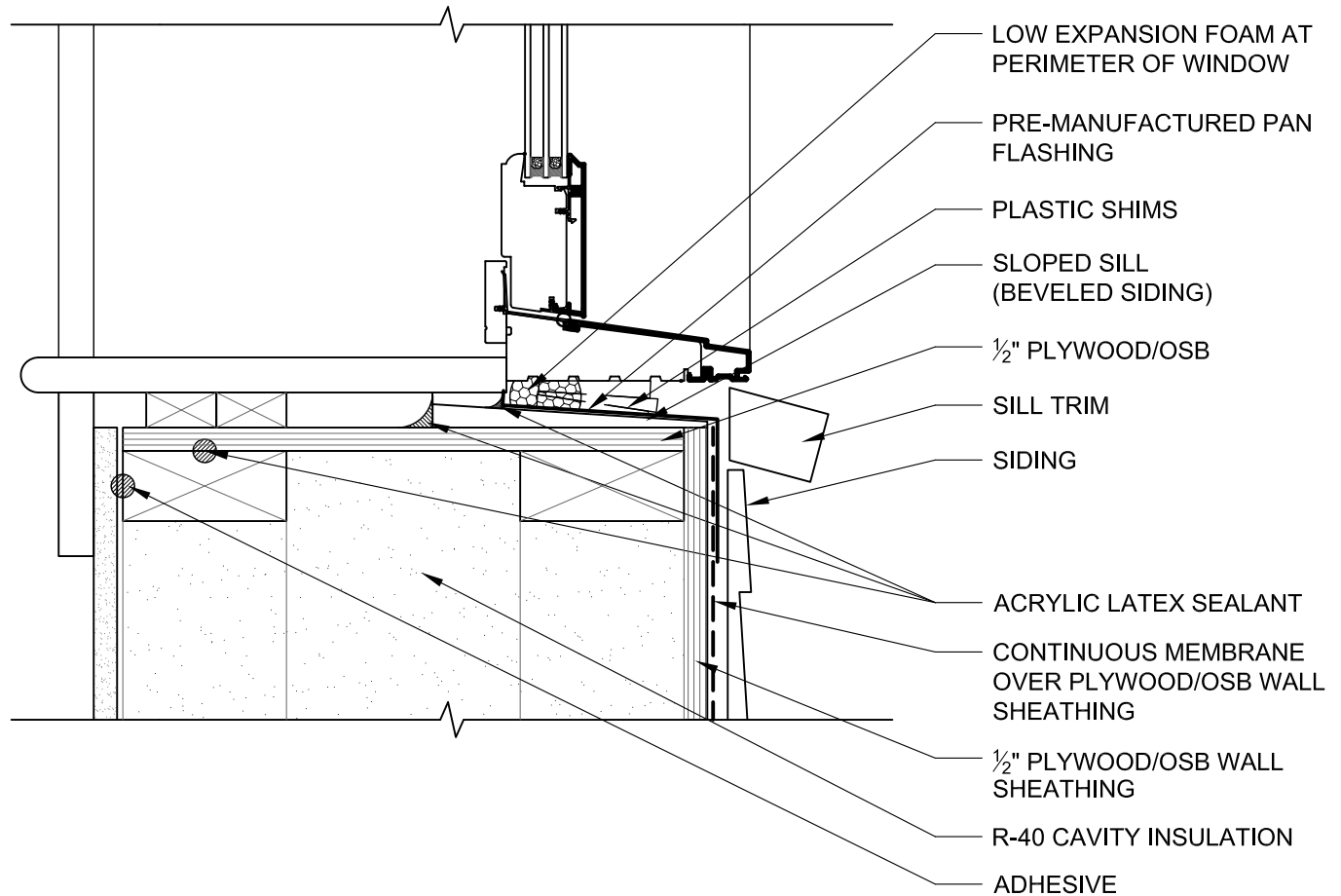
SCALE: 3" = 1'-0"



Water Management Details  
 Double Stud Wall  
 Date: 2013-06-07

Sheet Title:

# DSW-3



## WINDOW SILL DETAIL

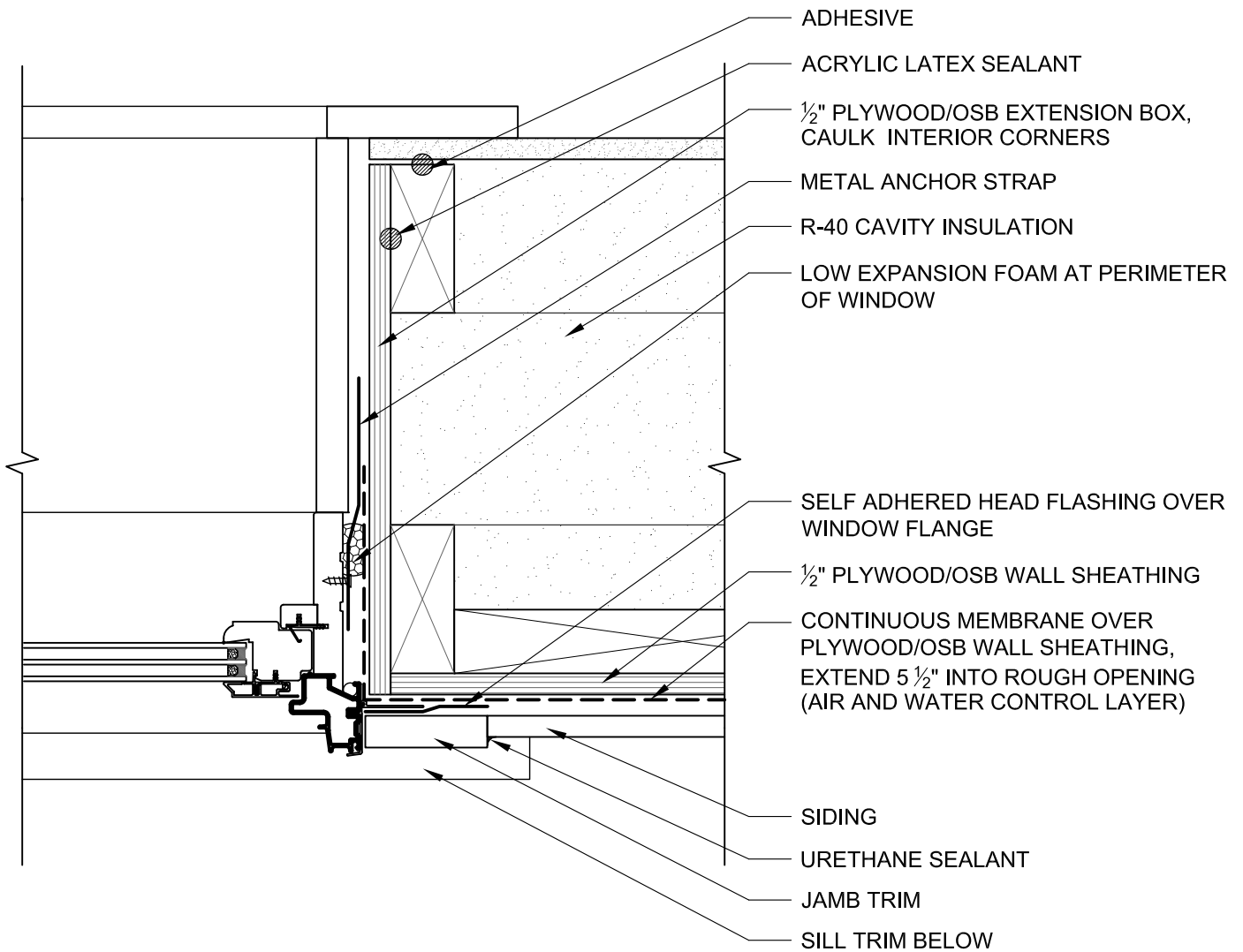
SCALE: 3" = 1'-0"



Water Management Details  
 Double Stud Wall  
 Date: 2013-06-07

Sheet Title:

**DSW-4**



# WINDOW JAMB DETAIL

SCALE: 3" = 1'-0"



with

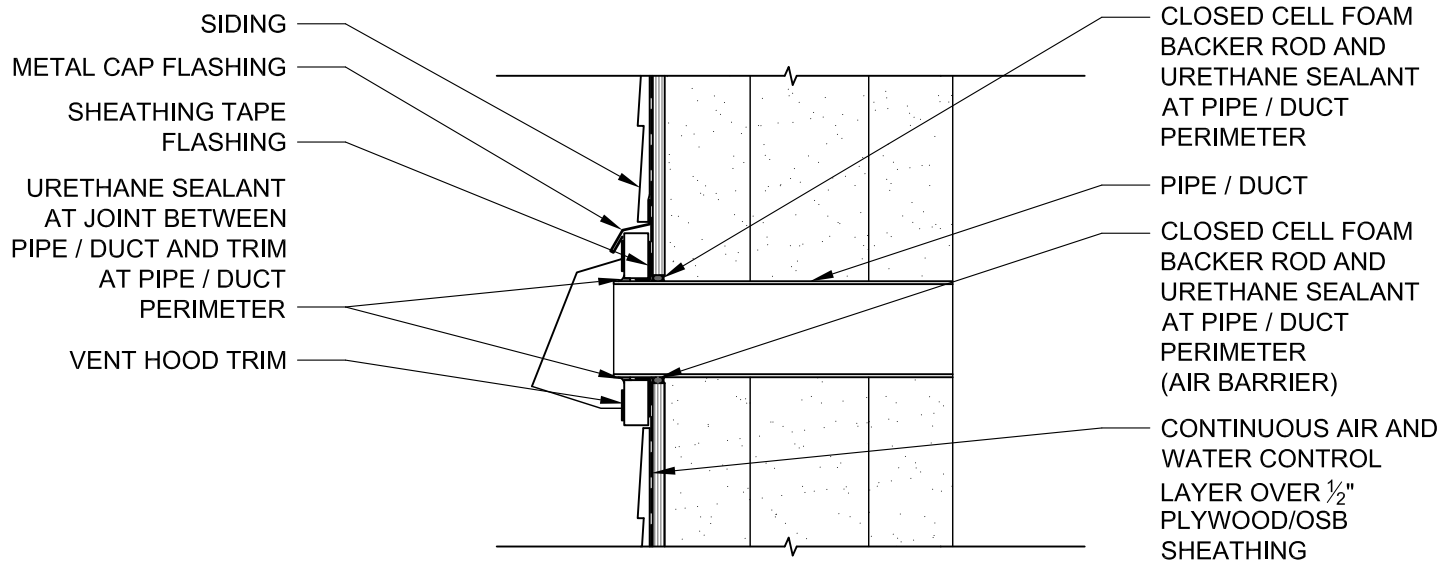


Water Management Details  
 Double Stud Wall  
 Date: 2013-06-07

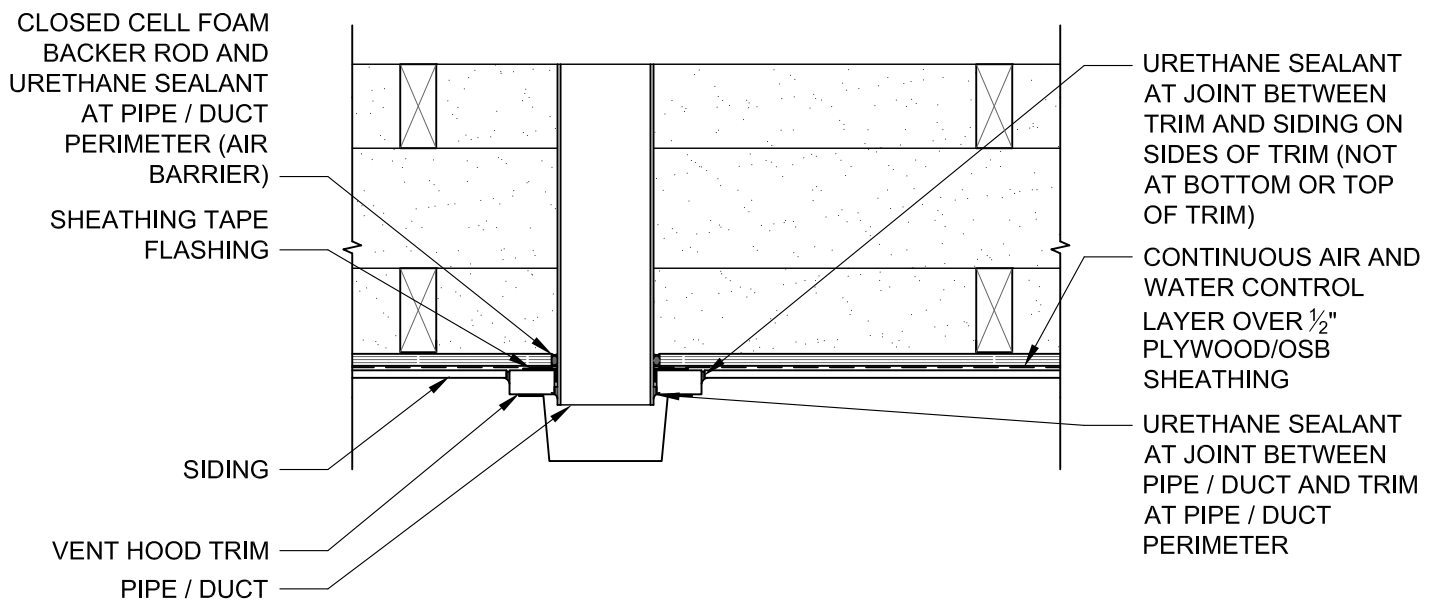
Sheet Title:

**DSW-5**





SECTION



PLAN

# MECHANICAL PENETRATION

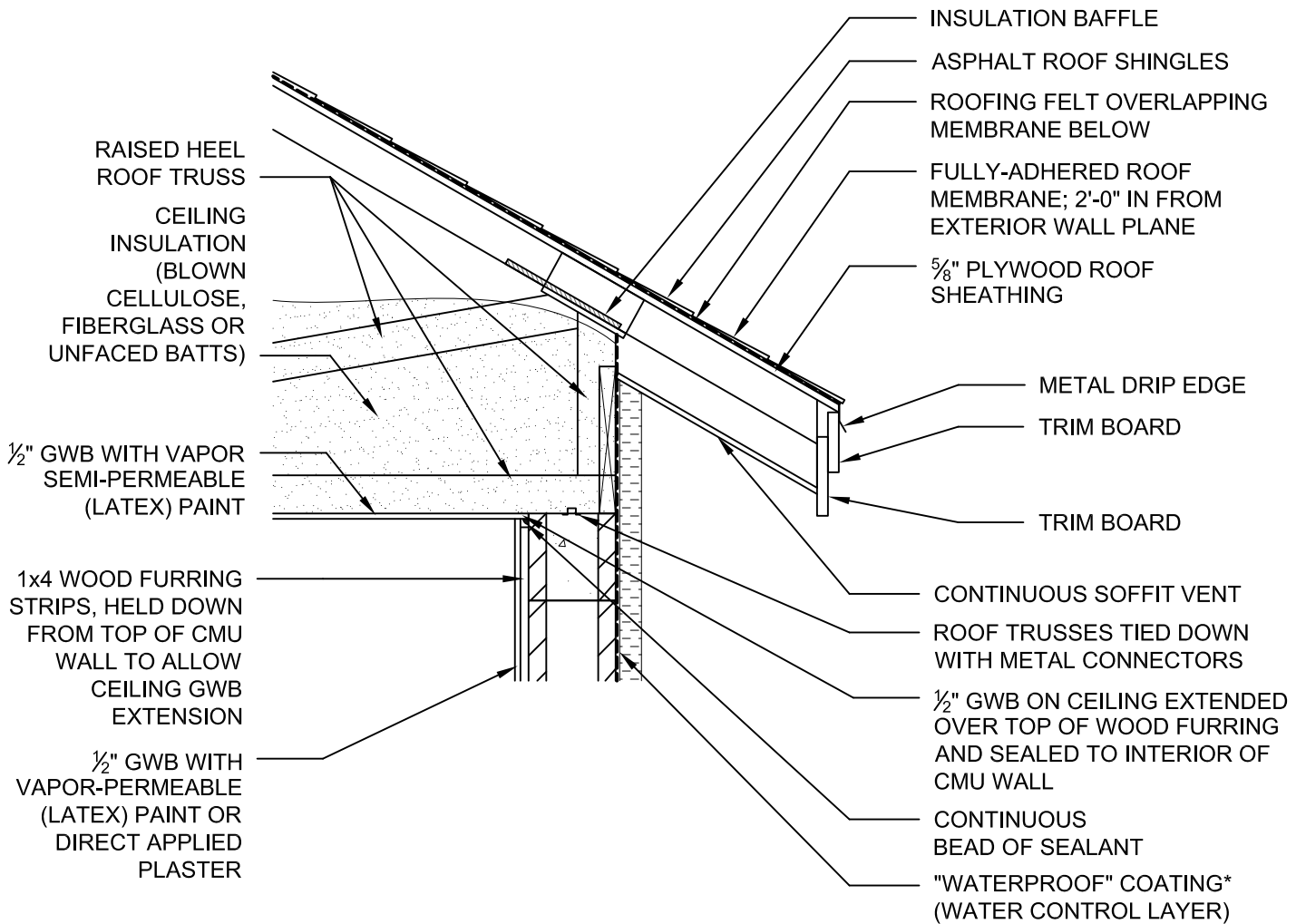
SCALE: 1 1/2" = 1'-0"



Water Management Details  
 Double Stud Wall  
 Date: 2013-06-07

Sheet Title:  
**DSW-6**

\* HIGH POLYMER CONTENT POLYMER-BASED (PB) SYNTHETIC STUCCO TOP COAT SUCH AS DRYFLEX BY DRYVIT, FLEXYL BY STO OR EQUAL. WATERPROOF IN THIS INSTANCE DOES NOT MEAN VAPOR PROOF. THESE PROPRIETARY COATINGS PASS WATER VAPOR; THEY ARE NOT VAPOR BARRIERS.



## ABOVE GRADE WALL TO ROOF

SCALE: 3/4" = 1'-0"



with



Water Management Details  
 CMU Wall with 2" EIFS  
 Date: 2013-06-07

Sheet Title:

CMU-1

\* HIGH POLYMER CONTENT POLYMER-BASED (PB) SYNTHETIC STUCCO TOP COAT SUCH AS DRYFLEX BY DRYVIT, FLEXYL BY STO OR EQUAL. WATERPROOF IN THIS INSTANCE DOES NOT MEAN VAPOR PROOF. THESE PROPRIETARY COATINGS PASS WATER VAPOR; THEY ARE NOT VAPOR BARRIERS.

LEDGER BOLTED TO WALL WITH EXPANDING BOLTS OR EPOXY SET FASTENERS

JOIST HANGER

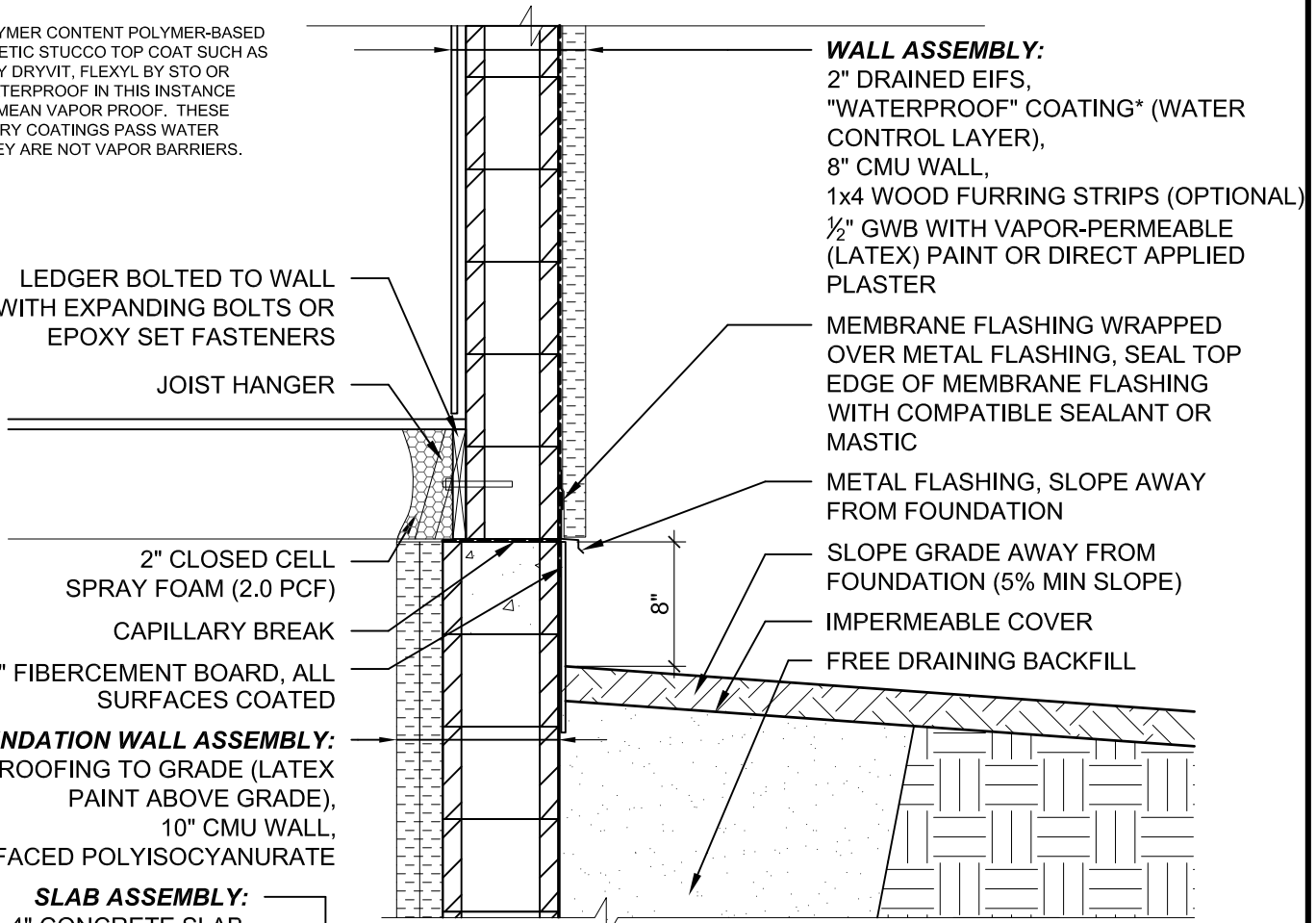
2" CLOSED CELL SPRAY FOAM (2.0 PCF)

CAPILLARY BREAK

3/8" FIBERCEMENT BOARD, ALL SURFACES COATED

**FOUNDATION WALL ASSEMBLY:**  
DAMP-PROOFING TO GRADE (LATEX PAINT ABOVE GRADE),  
10" CMU WALL,  
4" FOIL-FACED POLYISOCYANURATE

**SLAB ASSEMBLY:**  
4" CONCRETE SLAB,  
6 MIL POLYETHYLENE VAPOR BARRIER,  
2" XPS RIGID INSULATION,  
4" STONE PAD (NO FINES),  
UNDISTURBED/NATIVE SOIL



**WALL ASSEMBLY:**  
2" DRAINED EIFS,  
"WATERPROOF" COATING\* (WATER CONTROL LAYER),  
8" CMU WALL,  
1x4 WOOD FURRING STRIPS (OPTIONAL)  
1/2" GWB WITH VAPOR-PERMEABLE (LATEX) PAINT OR DIRECT APPLIED PLASTER

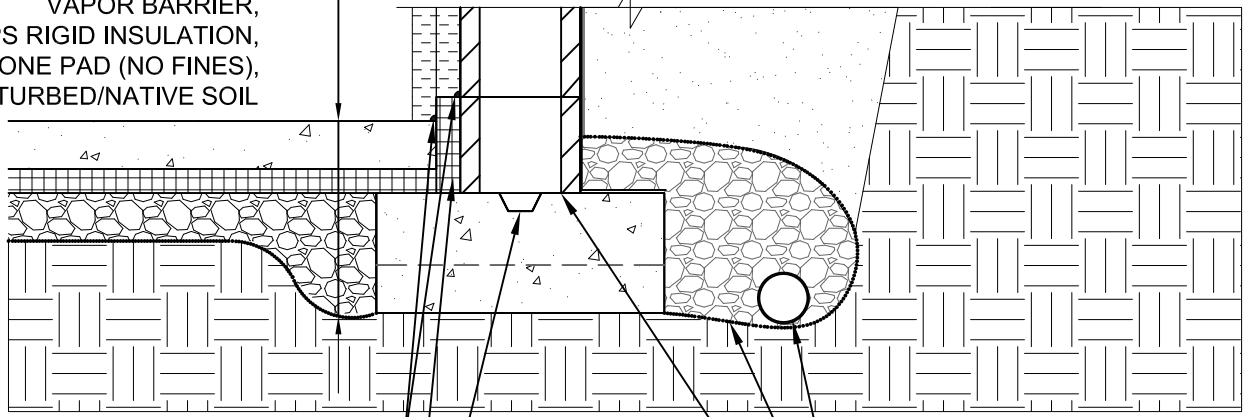
MEMBRANE FLASHING WRAPPED OVER METAL FLASHING, SEAL TOP EDGE OF MEMBRANE FLASHING WITH COMPATIBLE SEALANT OR MASTIC

METAL FLASHING, SLOPE AWAY FROM FOUNDATION

SLOPE GRADE AWAY FROM FOUNDATION (5% MIN SLOPE)

IMPERMEABLE COVER

FREE DRAINING BACKFILL



URETHANE SEALANT  
PERIMETER BOND BREAK (XPS)  
LIQUID APPLIED CAPILLARY BREAK ON TOP OF FOOTING

4" PERFORATED DRAIN PIPE  
FILTER FABRIC - WRAP AROUND GRAVEL  
KEYWAY

# FOUNDATION WALL TO ABOVE GRADE WALL

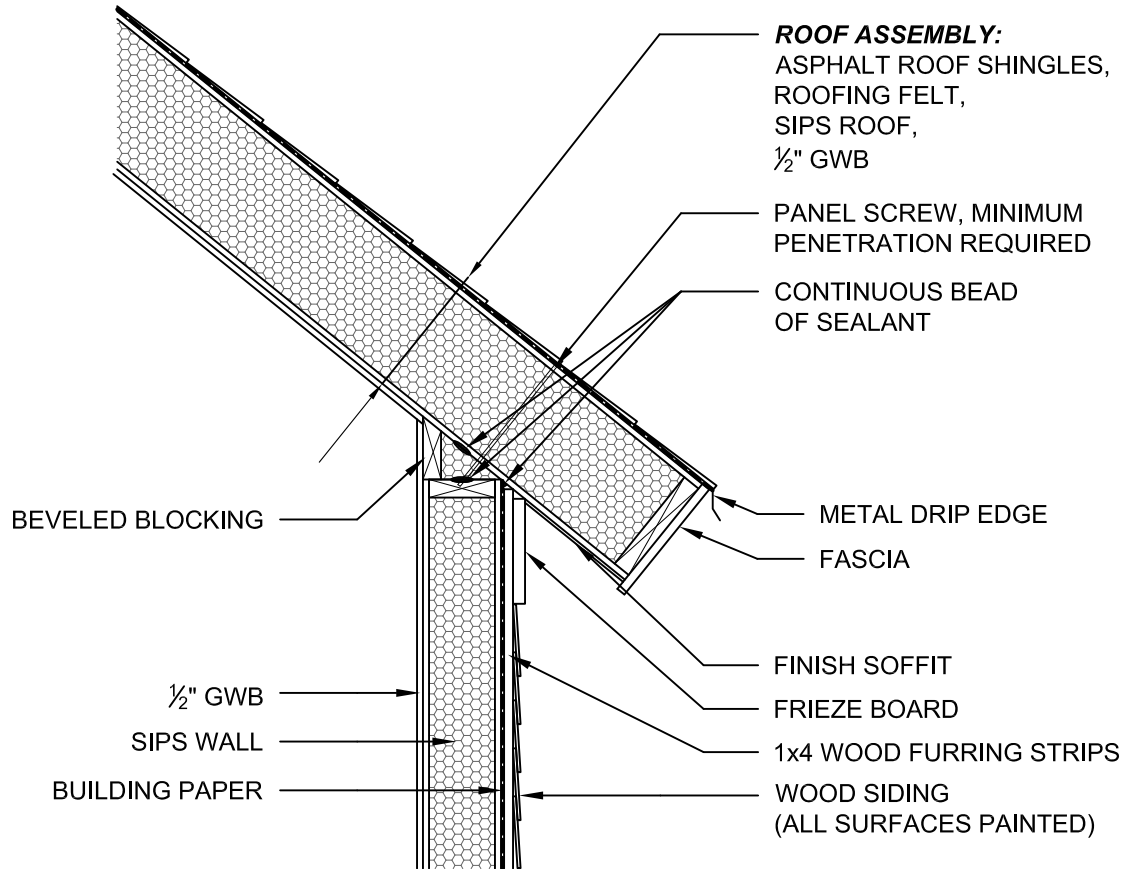
SCALE: 3/4" = 1'-0"



Water Management Details  
CMU Wall with 2" EIFS  
Date: 2013-06-07

Sheet Title:

## CMU-2



## ABOVE GRADE WALL TO ROOF

SCALE: 3/4" = 1'-0"



with

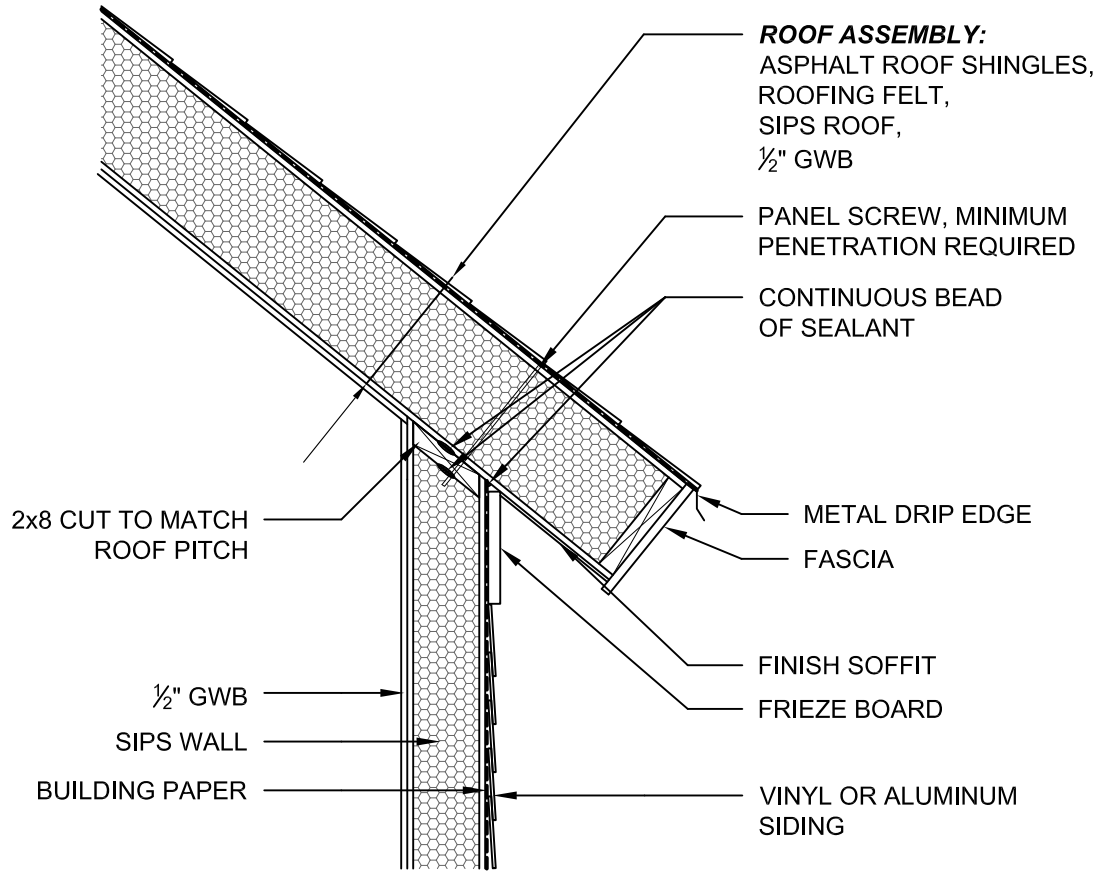


Water Management Details  
 SIPS Wall

Date: 2013-06-07

Sheet Title:

SIPS-1a



## ABOVE GRADE WALL TO ROOF

SCALE: 3/4" = 1'-0"



with

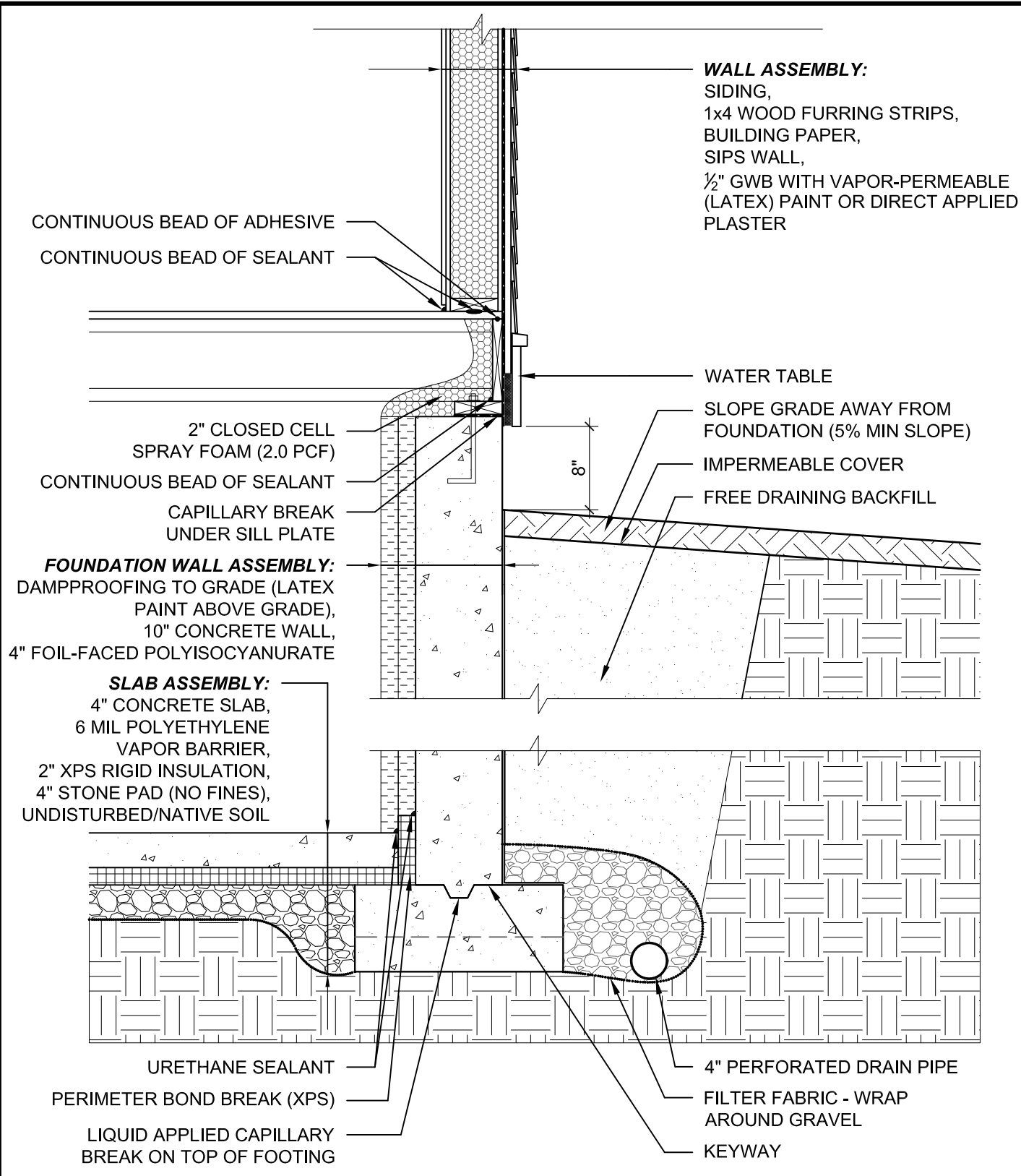


Water Management Details  
 SIPS Wall

Date: 2013-06-07

Sheet Title:

**SIPS-1b**



# FOUNDATION WALL TO ABOVE GRADE WALL

SCALE: 3/4" = 1'-0"



Water Management Details  
 SIPS Wall  
 Date: 2013-06-07

Sheet Title:  
**SIPS-2**

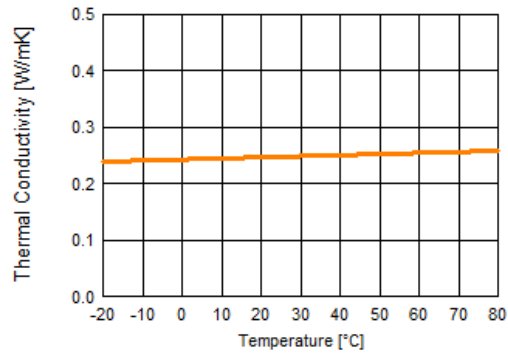
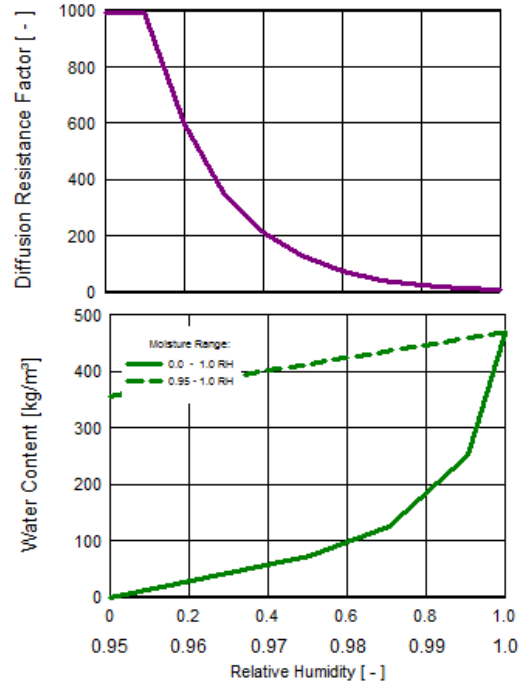
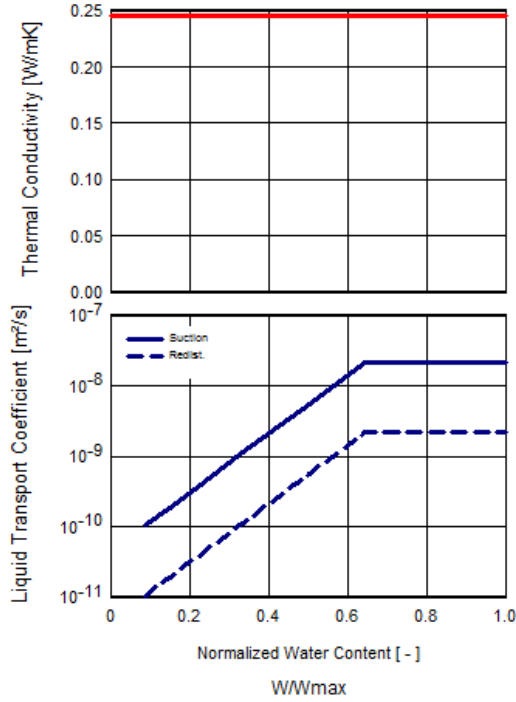
## Appendix B: Inputs for Hygrothermal Simulations

## Building America- 2.2- Moisture Management in High-R Walls

Material : Fibre Cement Sheathing Board

Checking Input Data

Property	Unit	Value
Bulk density	[kg/m <sup>3</sup> ]	1380.0
Porosity	[m <sup>3</sup> /m <sup>3</sup> ]	0.479
Specific Heat Capacity, Dry	[J/kgK]	840.0
Thermal Conductivity, Dry, 10°C	[W/mK]	0.245
Water Vapour Diffusion Resistance Factor	[-]	990.9
Temp-dep. Thermal Cond. Supplement	[W/mK <sup>2</sup> ]	0.0002

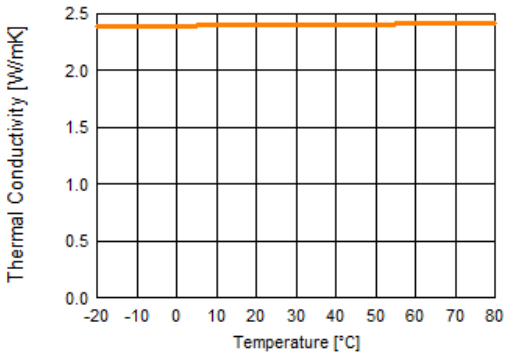
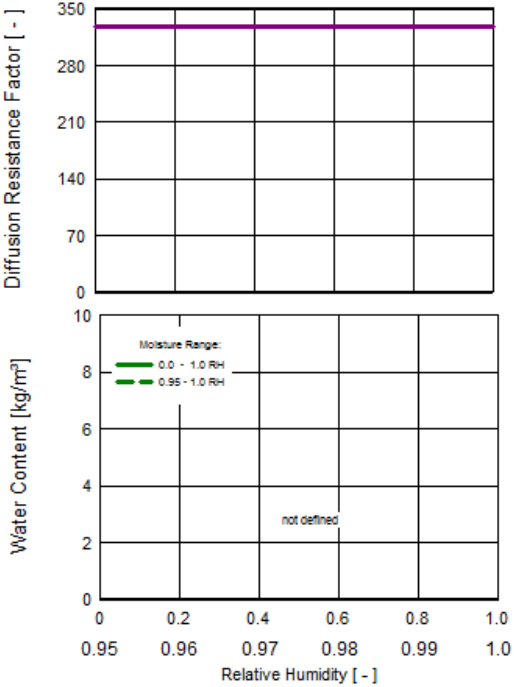
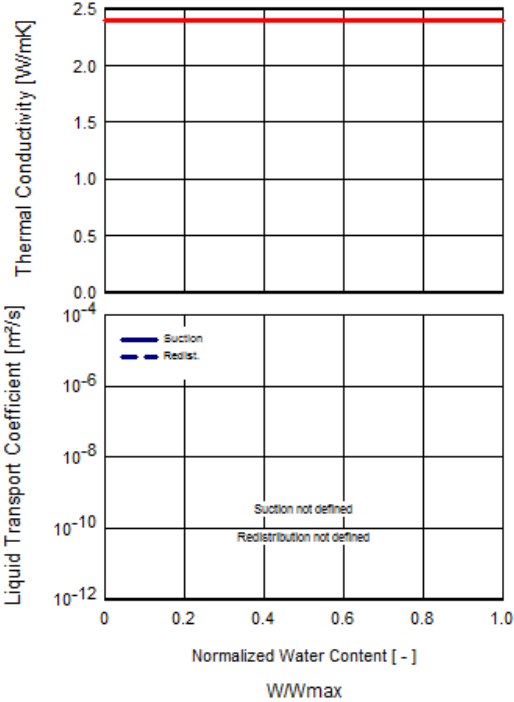




Material : Spun Bonded Polyolefine Membrane (SBP)

Checking Input Data

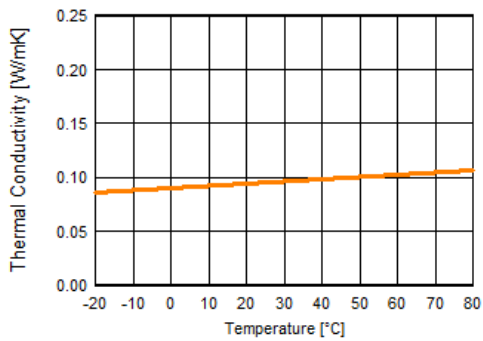
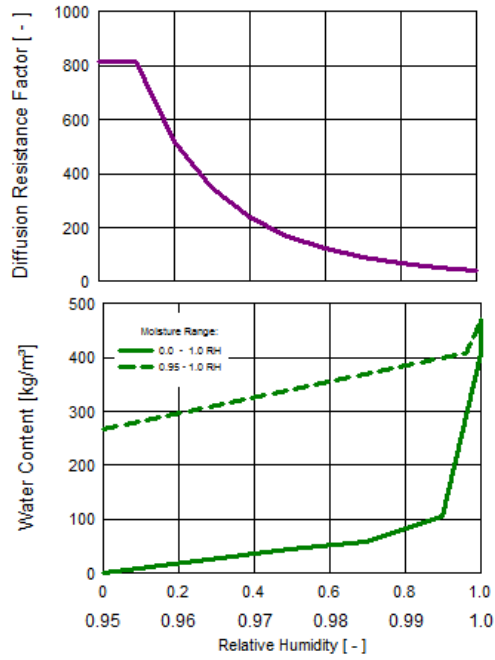
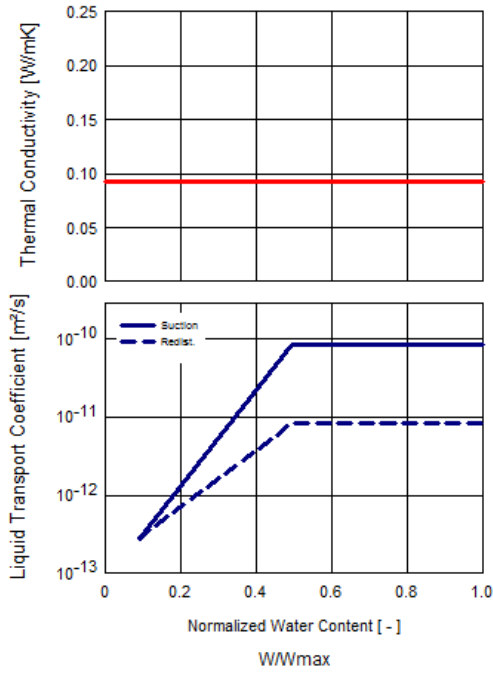
Property	Unit	Value
Bulk density	[kg/m <sup>3</sup> ]	448,0
Porosity	[m <sup>3</sup> /m <sup>3</sup> ]	0,001
Specific Heat Capacity, Dry	[J/kgK]	1500,0
Thermal Conductivity, Dry, 10°C	[W/mK]	2,4
Water Vapour Diffusion Resistance Factor	[-]	328,4
Temp-dep. Thermal Cond. Supplement	[W/mK <sup>2</sup> ]	0,0002



Material : Oriented Strand Board

Checking Input Data

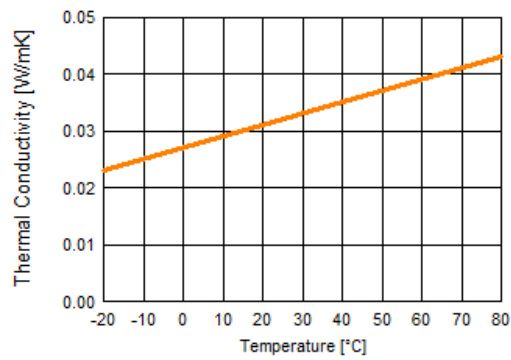
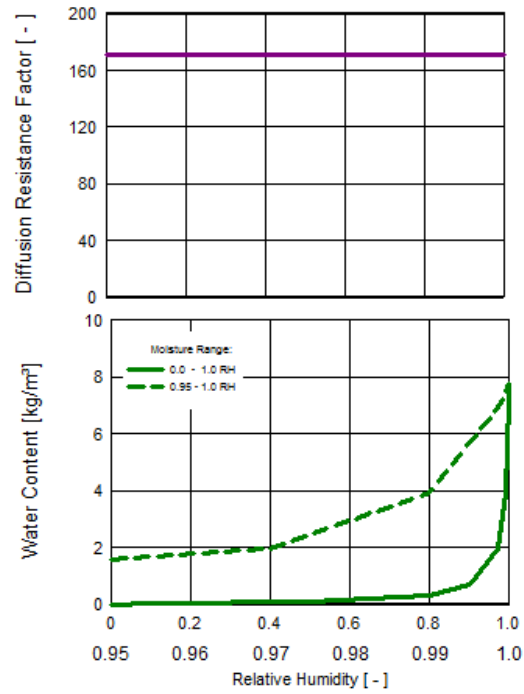
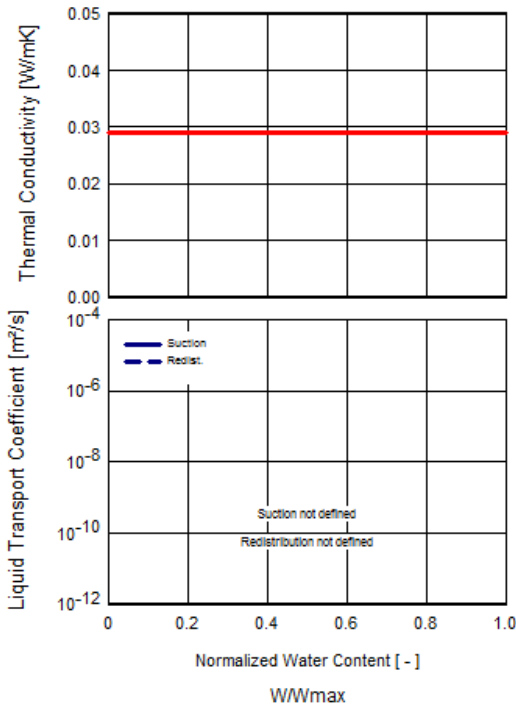
Property	Unit	Value
Bulk density	[kg/m <sup>3</sup> ]	650.0
Porosity	[m <sup>3</sup> /m <sup>3</sup> ]	0.95
Specific Heat Capacity, Dry	[J/kgK]	1880.0
Thermal Conductivity, Dry, 10°C	[W/mK]	0.092
Water Vapour Diffusion Resistance Factor	[-]	812.8
Reference Water Content	[kg/m <sup>3</sup> ]	63.3
Free Water Saturation	[kg/m <sup>3</sup> ]	470.0
Water Absorption Coefficient	[kg/m <sup>2</sup> *0.5]	0.0022
Temp-dep. Thermal Cond. Supplement	[W/mK <sup>2</sup> ]	0.0002



Material : Extruded Polystyrene Insulation R5-inch

Checking Input Data

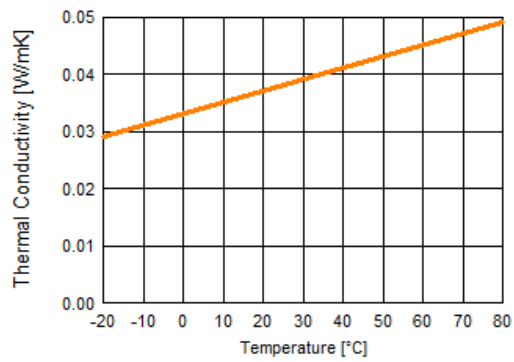
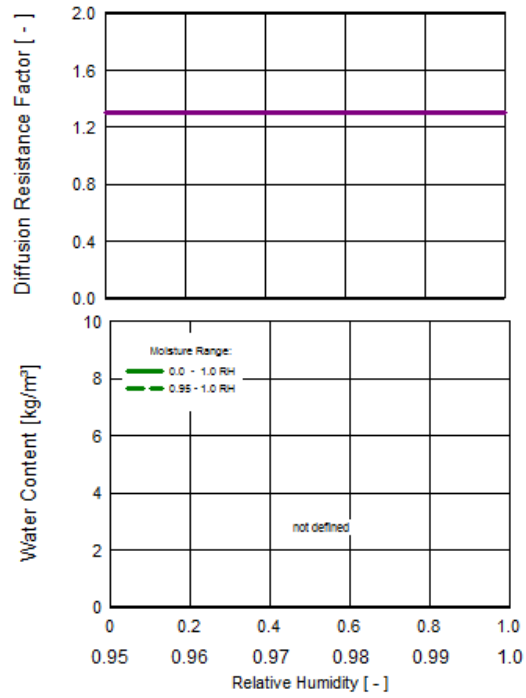
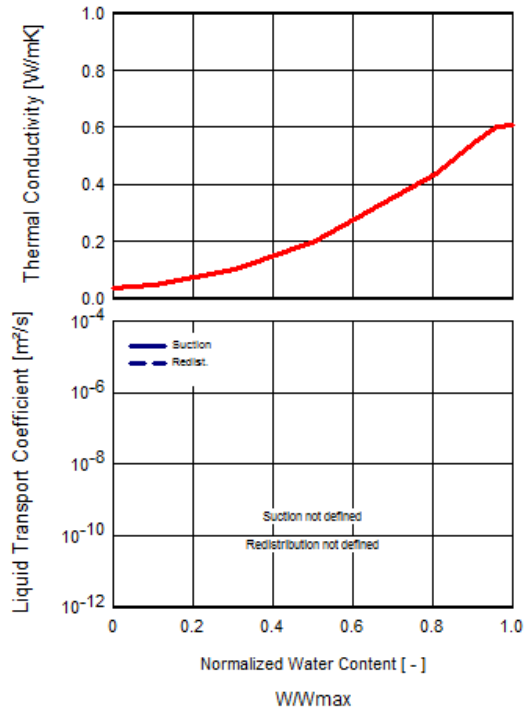
Property	Unit	Value
Bulk density	[kg/m <sup>3</sup> ]	28.6
Porosity	[m <sup>3</sup> /m <sup>3</sup> ]	0.99
Specific Heat Capacity, Dry	[J/kgK]	1470.0
Thermal Conductivity, Dry ,10°C	[W/mK]	0.029
Water Vapour Diffusion Resistance Factor	[-]	170.96
Temp-dep. Thermal Cond. Supplement	[W/mK <sup>2</sup> ]	0.0002



Material : Fibre Glass

Checking Input Data

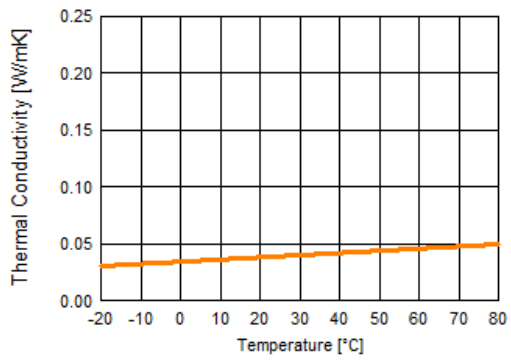
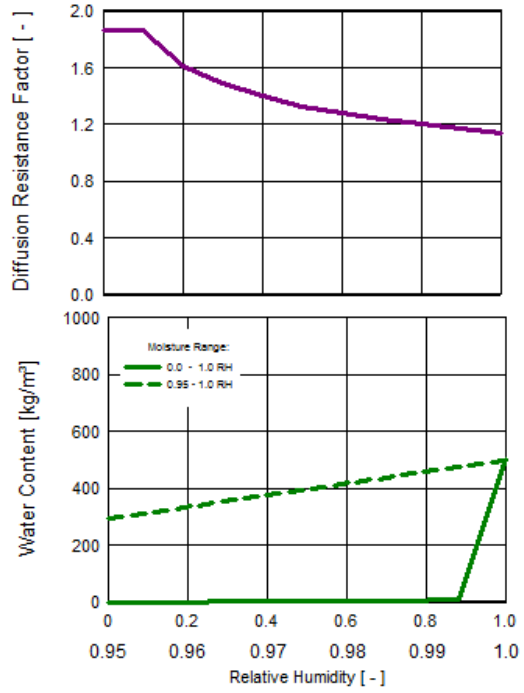
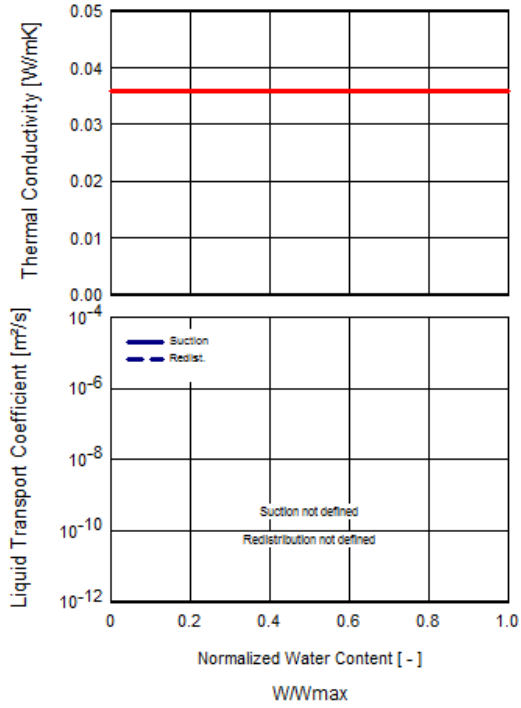
Property	Unit	Value
Bulk density	[kg/m <sup>3</sup> ]	30.0
Porosity	[m <sup>3</sup> /m <sup>3</sup> ]	0.99
Specific Heat Capacity, Dry	[J/kgK]	840.0
Thermal Conductivity, Dry, 10°C	[W/mK]	0.035
Water Vapour Diffusion Resistance Factor	[-]	1.3
Temp-dep. Thermal Cond. Supplement	[W/mK <sup>2</sup> ]	0.0002



# Material : Cellulose Fibre Insulation

## Checking Input Data

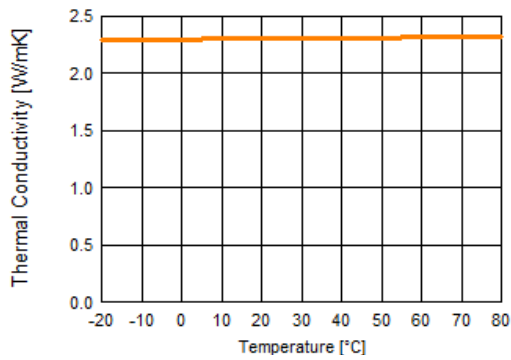
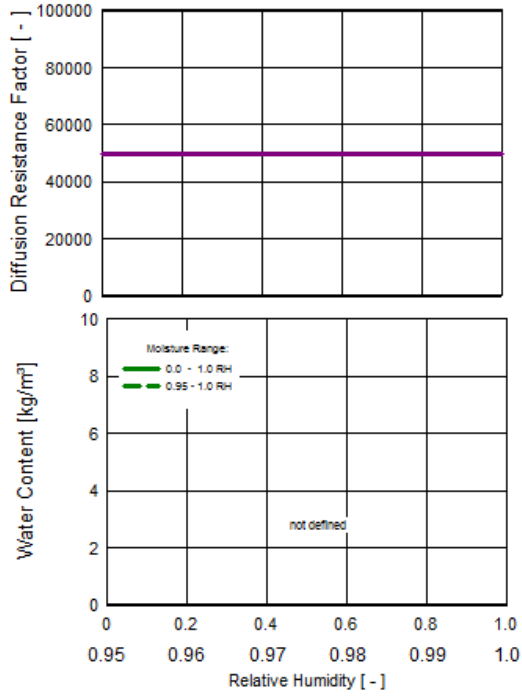
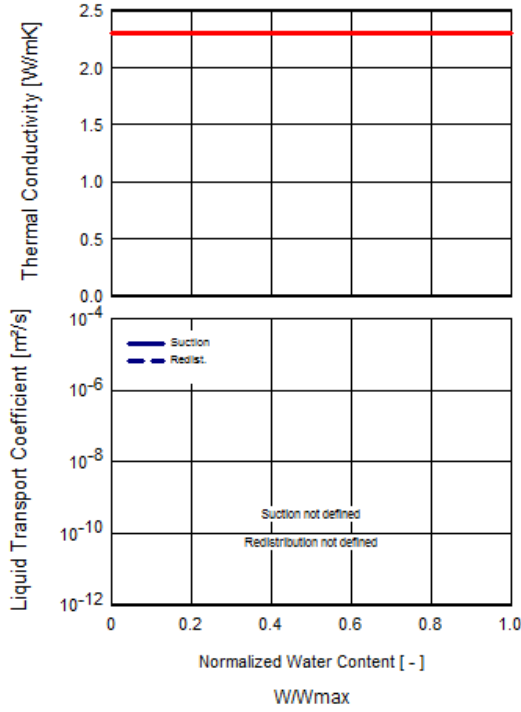
Property	Unit	Value
Bulk density	[kg/m <sup>3</sup> ]	30.0
Porosity	[m <sup>3</sup> /m <sup>3</sup> ]	0.99
Specific Heat Capacity, Dry	[J/kgK]	1880.0
Thermal Conductivity, Dry, 10°C	[W/mK]	0.036
Water Vapour Diffusion Resistance Factor	[-]	1.86
Temp-dep. Thermal Cond. Supplement	[W/mK <sup>2</sup> ]	0.0002



Material : PE-Membrane (Poly; 0.07 perm)

Checking Input Data

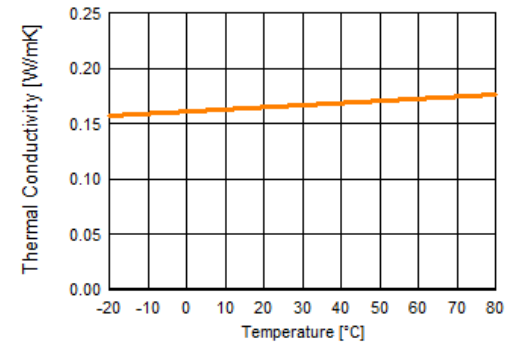
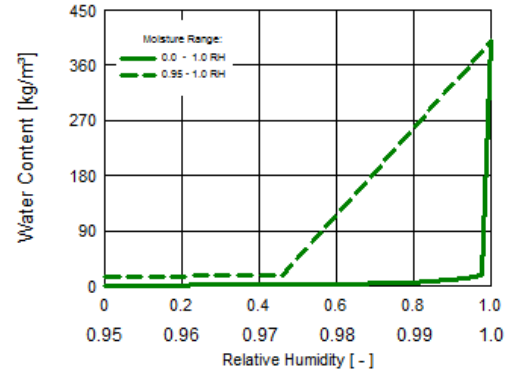
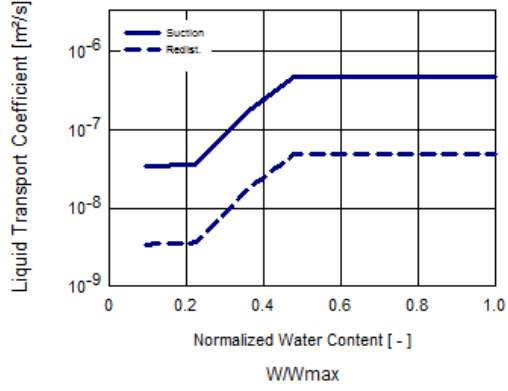
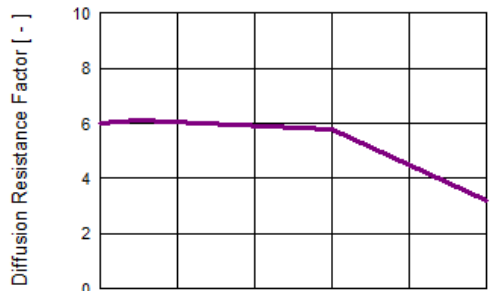
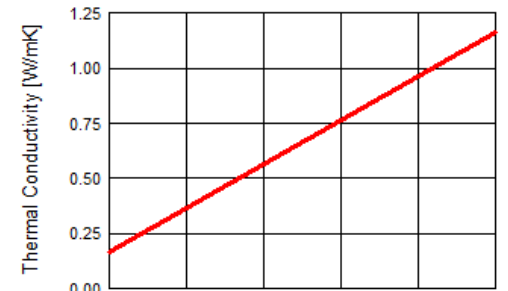
Property	Unit	Value
Bulk density	[kg/m <sup>3</sup> ]	130.0
Porosity	[m <sup>3</sup> /m <sup>3</sup> ]	0.001
Specific Heat Capacity, Dry	[J/kgK]	2300.0
Thermal Conductivity, Dry, 10°C	[W/mK]	2.3
Water Vapour Diffusion Resistance Factor	[-]	50000.0
Temp-dep. Thermal Cond. Supplement	[W/mK <sup>2</sup> ]	0.0002



Material : Gypsum Board (USA)

Checking Input Data

Property	Unit	Value
Bulk density	[kg/m³]	850.0
Porosity	[m³/m³]	0.65
Specific Heat Capacity, Dry	[J/kgK]	870.0
Thermal Conductivity, Dry, 10°C	[W/mK]	0.163
Water Vapour Diffusion Resistance Factor	[-]	6.0
Moisture-dep. Thermal Cond. Supplement	[%M-%s]	8.0
Temp-dep. Thermal Cond. Supplement	[W/mK²]	0.0002



# Boundary Conditions

## Exterior (Left Side)

Location: Chicago; cold year  
 Orientation / Inclination: North-East / 90 °

## Interior (Right Side)

Indoor Climate: WTA Guideline 6-2-01/E  
 User Defined Sine Curve Parameter

# Surface Transfer Coefficients

## Exterior (Left Side)

Name	Unit	Value	Description
Heat Resistance	[m²K/W]	0.0588	External Wall
Sd-Value	[m]	---	No coating
Short-Wave Radiation Absorptivity	[-]	0.8	
Long-Wave Radiation Emissivity	[-]	0.9	
Adhering Fraction of Rain	[-]	1	

## Interior (Right Side)

Name	Unit	Value	Description
Heat Resistance	[m²K/W]	0.125	External Wall
Sd-Value	[m]	.3	

# Explicit Radiation Balance

## Exterior (Left Side)

Name	Value
Enabled	no

# Sources, Sinks

## Air Layer 10 mm; without additional moisture capacity

Type	Name
Air Change	20ACH Ventilation

## 1mm Air-Drainage Gap

Type	Name
Moisture	1% WDR Leak

## \*Oriented Strand Board- Inner 3mm

Type	Name
Moisture	Source1



*buildingamerica.gov*

U.S. DEPARTMENT OF  
**ENERGY** | Energy Efficiency &  
Renewable Energy

DOE/GO-102013-4266 • November 2013

Printed with a renewable-source ink on paper containing at least 50% wastepaper, including 10% post-consumer waste.

## **BA-1316: Moisture Management for High R-Value Walls**

### About this Report

This report was prepared with the cooperation of the U.S. Department of Energy's Building America Program.

Direct all correspondence to: Building Science Corporation, 30 Forest Street, Somerville, MA 02143.

### Limits of Liability and Disclaimer of Warranty:

Building Science documents are intended for professionals. The author and the publisher of this article have used their best efforts to provide accurate and authoritative information in regard to the subject matter covered. The author and publisher make no warranty of any kind, expressed or implied, with regard to the information contained in this article.

The information presented in this article must be used with care by professionals who understand the implications of what they are doing. If professional advice or other expert assistance is required, the services of a competent professional shall be sought. The author and publisher shall not be liable in the event of incidental or consequential damages in connection with, or arising from, the use of the information contained within this Building Science document.