

Kohta Ueno

Multifamily Humidity Control Problems: Muggy Mayhem

August 1, 2023



1

Thanking (a few) Mentors-the Technical Knowledge



Joe Lstiburek



John Straube



Andy Åsk

2

Thanking (a few) Mentors-the Technical Knowledge



Joe "Hoser" Lstiburek



John "Danger" Straube



Andy "Santa" Ask

Summer Camp XXV: Multifamily Humidity Control Problems: Muggy Mayhem

© buildingscience.com

3

3

Problem Background and Symptoms

Summer Camp XXV: Multifamily Humidity Control Problems: Muggy Mayhem

© buildingscience.com

4

4

What We Hear from the Field (The Problem)

- Multifamily buildings, new construction (typical)
- Condensation, staining, and mold on cooling registers, exhausts
- Staining, and mold and on furnishings & clothing
- Ductwork in ceiling cavity: condensation & dripping (sometimes)
- Occupants report high humidity—
“cold but clammy”
- Adding dehumidifier in units typically helps
- Owners need a longer-term solution, not a band-aid



Summer Camp XXV: Multifamily Humidity Control Problems: Muggy Mayhem

© buildingscience.com ⁵

5

Pennsylvania Example



Summer Camp XXV: Multifamily Humidity Control Problems: Muggy Mayhem

© buildingscience.com ⁶

6

Georgia Example



Summer Camp XXV: Multifamily Humidity Control Problems: Muggy Mayhem

© buildingscience.com

7

Long Island/NY Example

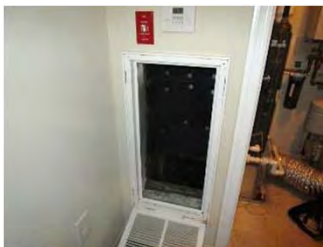

Summer Camp XXV: Multifamily Humidity Control Problems: Muggy Mayhem

8
© buildingscience.com

8

Baltimore MD Example

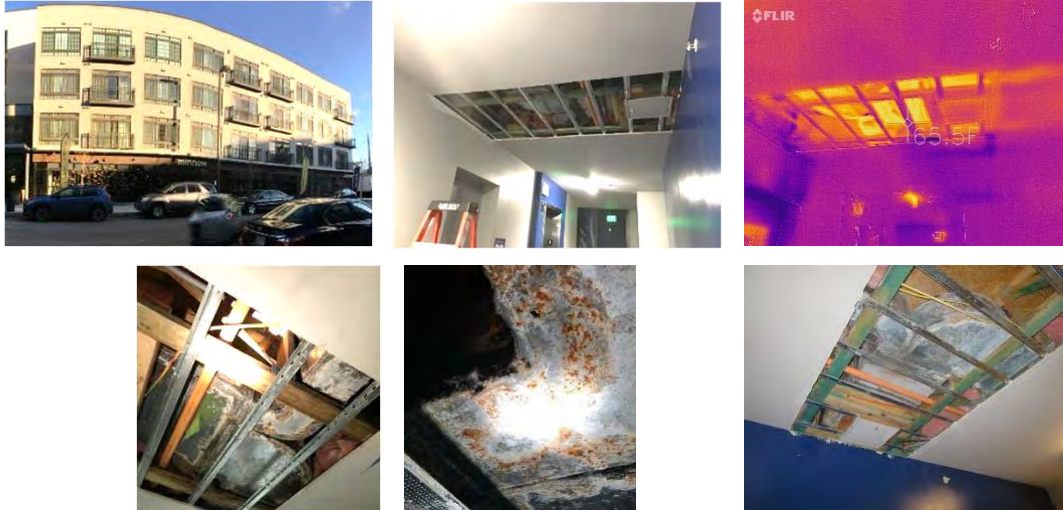

Summer Camp XXV: Multifamily Humidity Control Problems: Muggy Mayhem

© buildingscience.com

9

9

Where Are These Happening?

- East Coast (4A) dominant
- Some hot-humid (2A, 3A)
- Typically, mid-rise multifamily (also townhomes, hotels, assisted living facilities)
- Typically, new or recent construction/renovation
- Anecdotally, Energy Star or efficient construction (“...this didn’t happen on the last job!”)

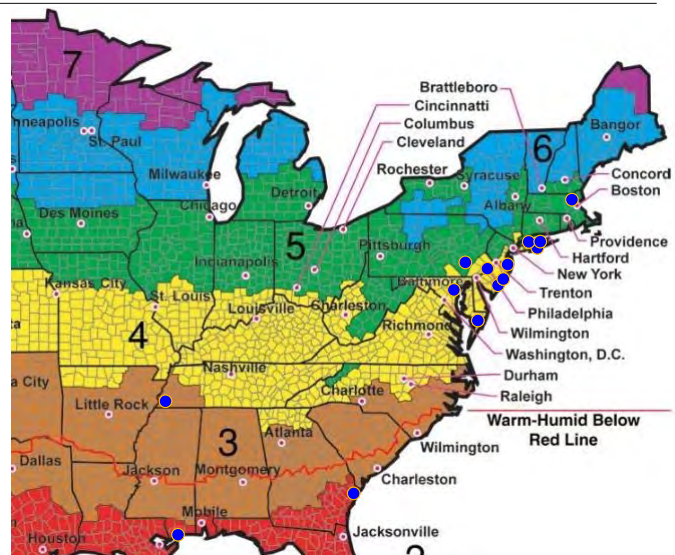

Summer Camp XXV: Multifamily Humidity Control Problems: Muggy Mayhem

© buildingscience.com

10

10

What We're Covering

- Indoor and Outdoor Moisture
- Cooling Sizing: Enclosures & Loads
- Mechanical Ventilation Systems & Multifamily Buildings
- Air Leakage and Humidity
- Mechanical Systems and Dehumidification
- Mechanical Dehumidification Solutions
- Case Studies

11

Indoor and Outdoor Moisture

12

Interior Relative Humidity

- Sterling chart (1986)
- Health and indoor air quality vs. interior humidity
- Keep interior relative humidity below 60% (summertime problem)
- High RHs → mold risks as visible problem/symptom

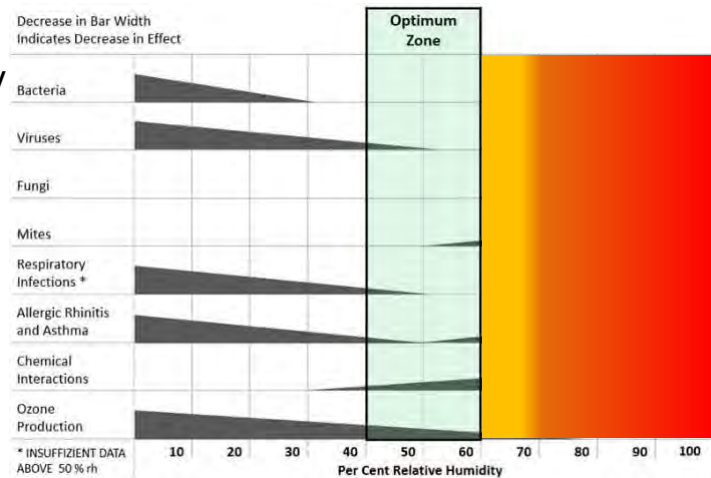

Summer Camp XXV: Multifamily Humidity Control Problems: Muggy Mayhem

13
© buildingscience.com

13

Indoor and Outdoor Dewpoint

- “Thinking in dewpoint” (not grains, VP)
- **50 F DP**: 70 F/50% RH; California & Mediterranean climate
- **60 F DP**: starts to feel unpleasant
- **70 F DP**: peaks of summer East Coast
- **80 F DP**: worst of Florida
- ASHRAE: keep **DP < 60 F** in bui with AC
- PsychroApp calculator app

Munters PsychroApp™

Alt, ft: 0

Input: 79.70 °F db, 84.50 %RH

Output: 79.70 °F db, 74.61 °F dp, 0.864 in Hg vp, 39.51 Btu/lb

Summer Camp XXV: Multifamily Humidity Control Problems: Muggy Mayhem

14
© buildingscience.com

14

Indoor and Outdoor Dewpoint

Long Island (East Farmingdale NY)

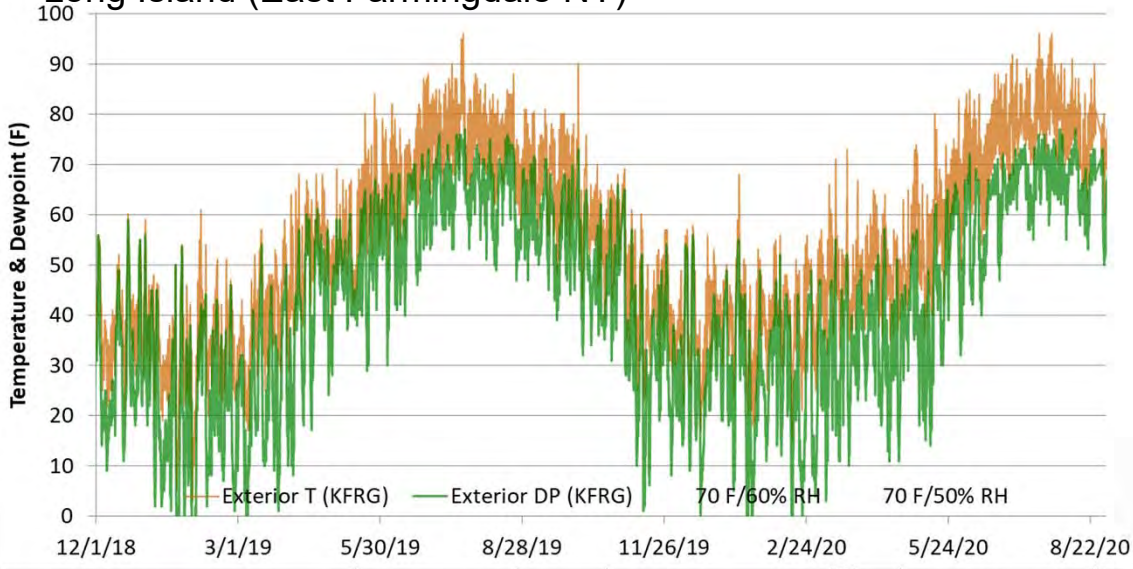

15

Indoor and Outdoor Dewpoint

Long Island (East Farmingdale NY)

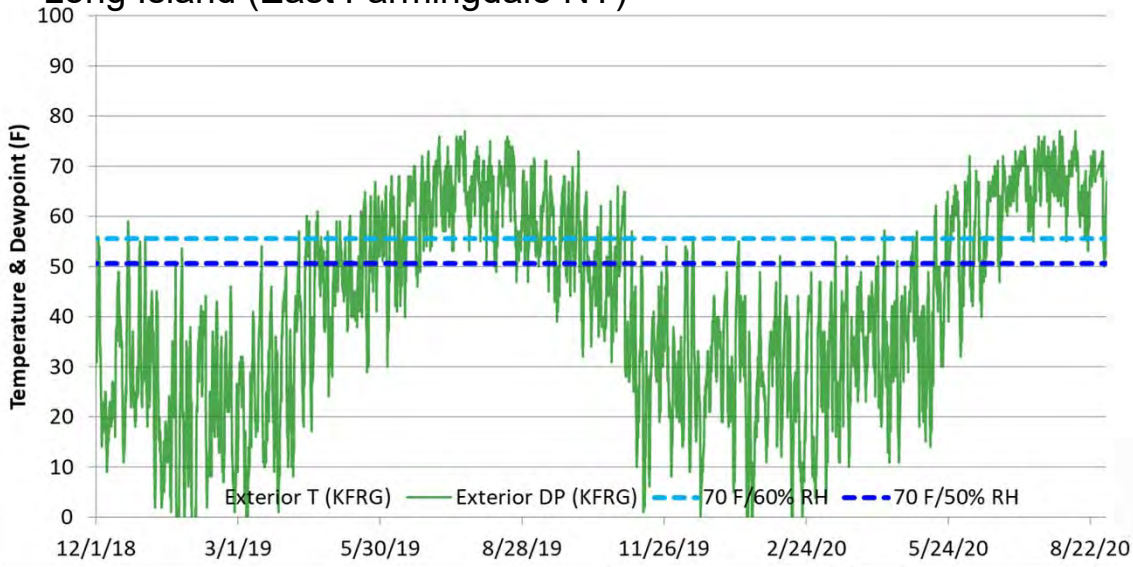

16

Interior vs. Exterior Moisture

- “You’re building too tight, and the moisture’s trapped inside!”
- Winter problems: yes
- Summer problems: no
- Summertime humidity problems: ***untreated outside air***
 - Unless massive interior moisture source
- Ventilation/overventilation
- Air leakage
- Poor dehumidification

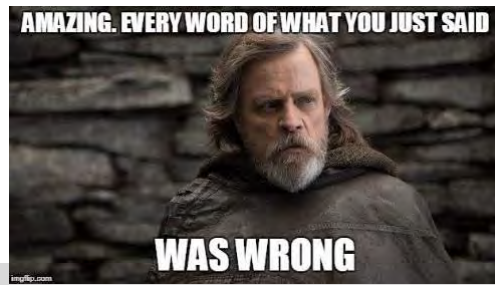
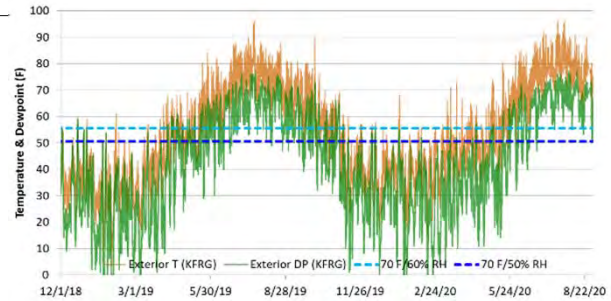

Summer Camp XXV: Multifamily Humidity Control Problems: Muggy Mayhem

17
© buildingscience.com

17

Cooling Sizing: Enclosures & Loads

Summer Camp XXV: Multifamily Humidity Control Problems: Muggy Mayhem

18
© buildingscience.com

18

Mechanicals Overview

- Cooling is only dehumidification mechanism available (typically)
- HVAC controlled by temperature not humidity (typically)
- “Incidental dehumidification” from cooling operation

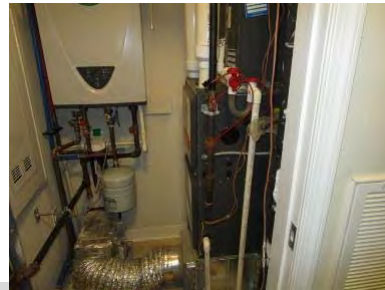

Summer Camp XXV: Multifamily Humidity Control Problems: Muggy Mayhem

19
© buildingscience.com

19

Houston Dehumidification Research (2002)

- Building America project improving single family new construction
- Improved energy efficiency
 - Ducts inside (unvented attic)
 - Glazing from single to double low E
 - Upgraded insulation
 - High efficiency mechanicals
- 5% → 23% of hours over 60% RH
- Improved enclosure → less AC runtime → less dehumidification

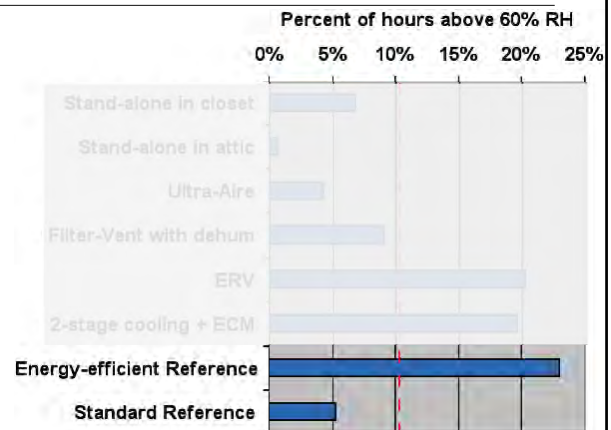

Summer Camp XXV: Multifamily Humidity Control Problems: Muggy Mayhem

20
© buildingscience.com

20

Multifamily Equipment

- Sealed combustion or heat pump air handlers typical (split systems)
- Ductwork in ceiling above unit
- High(er) efficiency equipment generally



Summer Camp XXV: Multifamily Humidity Control Problems: Muggy Mayhem

21
© buildingscience.com

21

Multifamily Building Cooling Loads

- Some “sides of the cube” have ~zero load
 - Middle, corner, roof units
- Peak design loads-Philly
 - ~7000-9000 Btu/hr per unit
 - Bad assumptions-big impacts
- Installed equipment:
 - 1-½ ton AC (18,000 Btu/hr)
- Oversized x2 on design day (35 hottest hours/year)

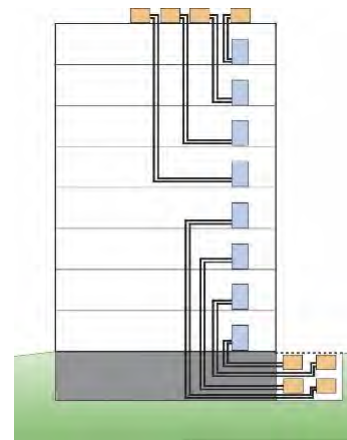
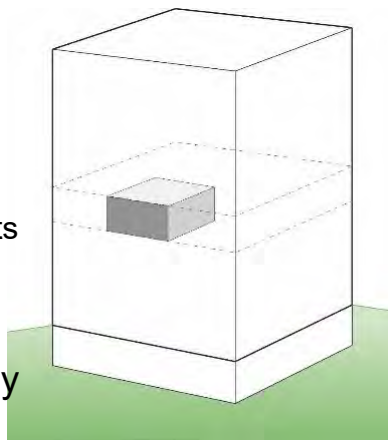

Summer Camp XXV: Multifamily Humidity Control Problems: Muggy Mayhem

22
© buildingscience.com

22

Multifamily Building Cooling Loads

- Townhomes and over/under units have problems too! (1000-1300 sf)
- 2 ton ACs at each unit
- **Equipment** + **Lighting** adds ~1 ton?!
- Manual J “arbitrary safety factors indefensible”
- Efficient lighting → less waste heat
 - Calcs assume 1000 W @ peak load
- With more reasonable loads: under 1 ton per unit

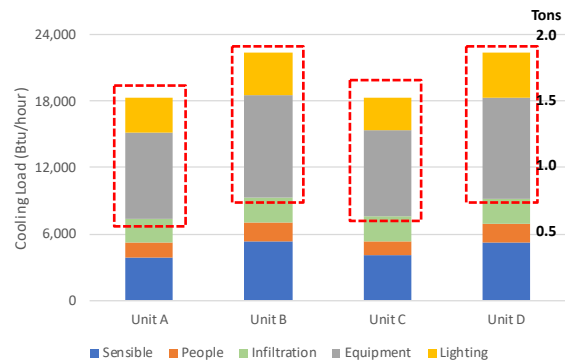

23

Multifamily Building Cooling Loads

- Townhomes and over/under units have problems too! (1000-1300 sf)
- 2 ton ACs at each unit
- **Equipment** + **Lighting** adds ~1 ton?!
- Manual J “arbitrary safety factors indefensible”
- Efficient lighting → less waste heat
 - Calcs assume 1000 W @ peak load
- With more reasonable loads: under 1 ton per unit

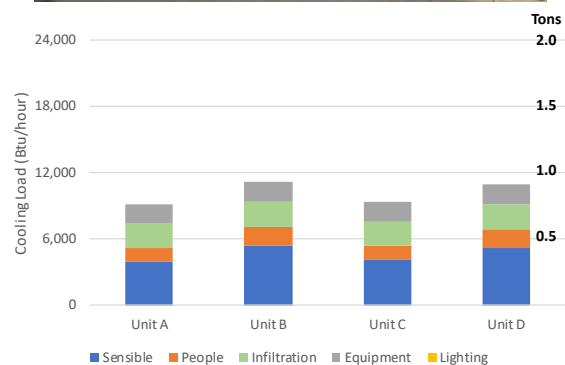

24

Sensible & Latent Loads

- Sensible = temperature-based load
- Latent = moisture/dehumidification load
- SHR = “sensible heat ratio”
 - SHR = 0.7 = 70% sensible, 30% latent
- AC equipment: ratio of how much ‘incidental dehumidification’ happens when cooling
 - Equipment SHR varies (limited range)
- Building’s SHR (sensible vs. latent loads)
- Sensible load ↓, latent load (ventilation, occupants) stays the same
- “A sensible-latent mismatch between equipment and building loads”

25

High Efficiency Air Conditioner Units

- “Percent Sensible Capacity” (remainder = latent/moisture)
- Startup = all sensible no latent
- Old ~10 SEER equipment: more latent capacity faster
- Newer high SEER: less latent capacity, longer time
 - Larger coils for higher efficiency
- **Short cycling due to oversized equipment**

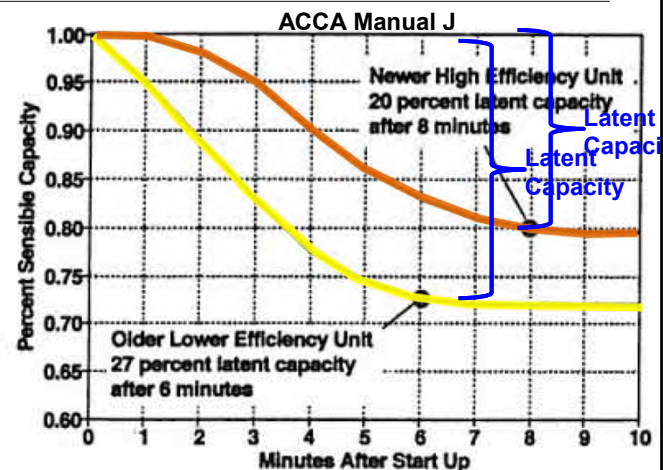

26

Mechanical Ventilation Systems & Multifamily Buildings

27

Exhaust-Only Ventilation

- Lowest cost (developer's choice)
- Depressurizes building ("induced infiltration")
- Draws air from wherever leaks are (unknown sources)
- Draws air from crawl spaces, basements, attics, garages...
- In multifamily: air from adjacent units, corridors, shafts...

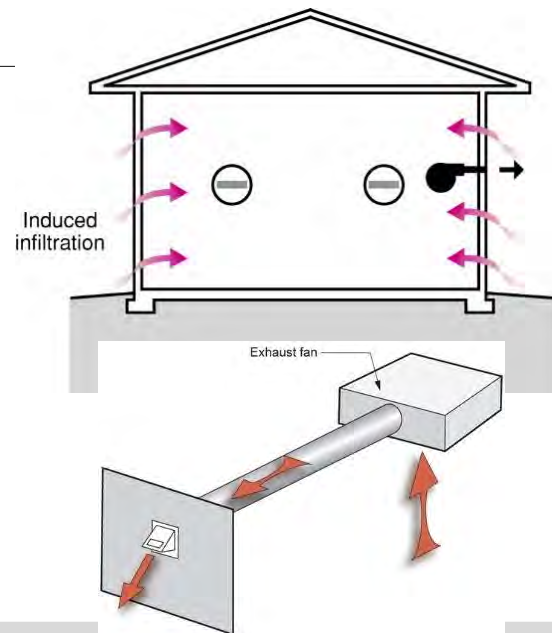

28

Supply-Only Ventilation

- Pressurizes building (“induced exfiltration”)
- Draws air from known source
- Mixing or preheating required for comfort
- Central fan integrated ventilation (outside air duct to return, motorized damper)

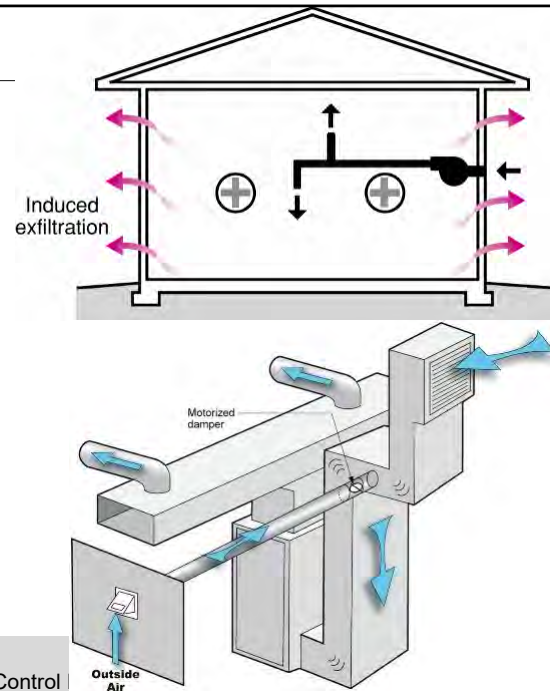

Summer Camp XXV: Multifamily Humidity Control

29

Balanced Ventilation (HRVs & ERVs)

- Building pressure neutral
- Draws air from known source
- Works with tighter construction, multifamily
- Heat recovery → energy performance
- Highest cost

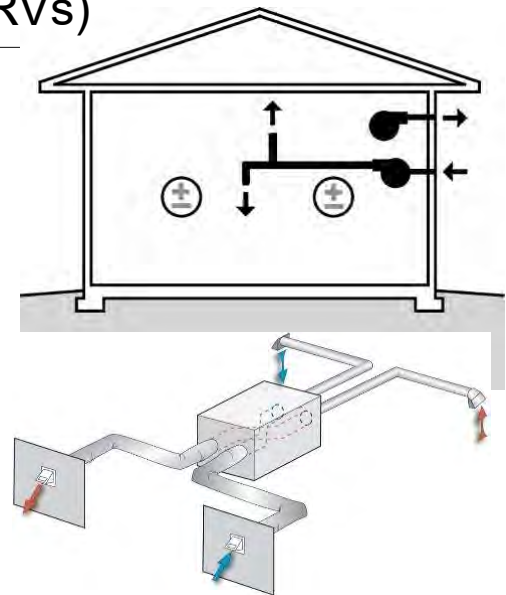

Summer Camp XXV: Multifamily Humidity Control Problems: Muggy Mayhem

30
© buildingscience.com

30

Multifamily Ventilation

- Central unit (rooftop)?
- Individual ventilation systems?
- Floor-by-floor systems?
- CFIS + exhaust
- Balanced systems are recommended approach
- HRV/ERV and independent heating/cooling

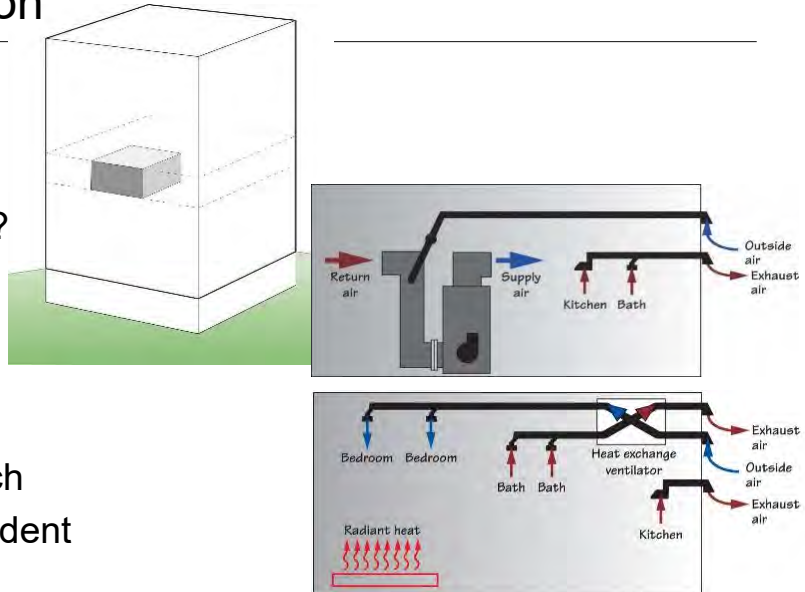

Summer Camp XXV: Multifamily Humidity Control Problems: Muggy Mayhem

31
© buildingscience.com

31

Exhaust-Only Plus Trickle Vents

- “Adding a hole to outdoors”
- Area of hole vs. area of all other leaks
- Unit must be incredibly tight for trickle vent as outside air source
- 100 CFM unit exhaust, 10 CFM flow



Summer Camp XXV: Multifamily Humidity Control Problems: Muggy Mayhem

32
© buildingscience.com

32

Exhaust Airflow Rates

- Energy Star & building code requirements
- Measure airflows—overventilating?
- Current exhaust fans ramp up to target flow
- Two bathrooms per unit w. exhausts
 - Design: one constant, one intermittent/switched
 - Actual: both constant—doubled ventilation rate



Summer Camp XXV: Multifamily Humidity Control Problems: Muggy Mayhem

33
© buildingscience.com

33

Ventilation Rates

- Old ASHRAE 62.2: 7.5 cfm/occupant + **0.01** cfm/sf floor area
- ASHRAE 62.2-2013 7.5 cfm/occupant + **0.03** cfm/sf floor area
- 2 BR, 1000 sf = **33 CFM (old)**
vs. 53 CFM (new)
- Outdoor air = moisture loads
- Over-specified flows to make up for bad distribution
- Pandemic ventilation rate increases?

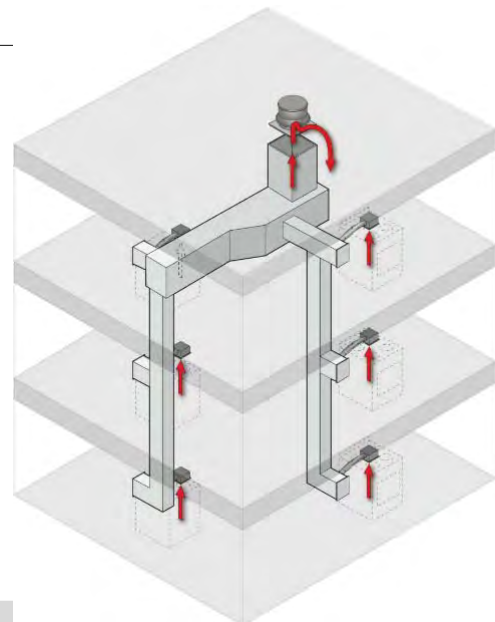

Summer Camp XXV: Multifamily Humidity Control Problems: Muggy Mayhem

34
© buildingscience.com

34

Air Leakage and Humidity

35

Air Leakage and Humidity

- Outside air → summertime moisture
- Exhaust-only ventilation: makeup air enters at biggest remaining holes
- Energy Star/High Performance: often air leakage testing done...
- Remaining leaks are often tricky or weird problems

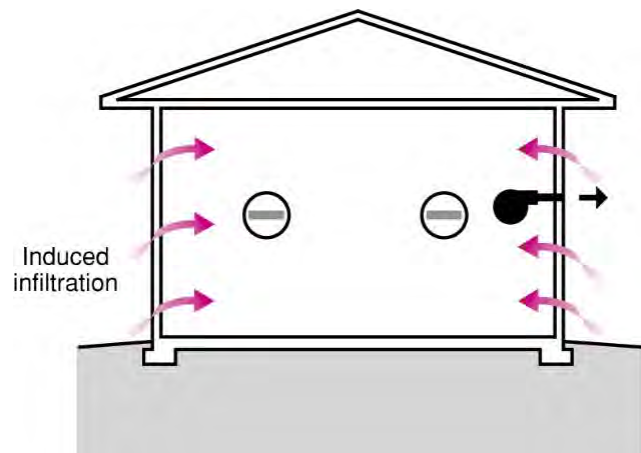

36

Open Web Floor Truss Air Leaks

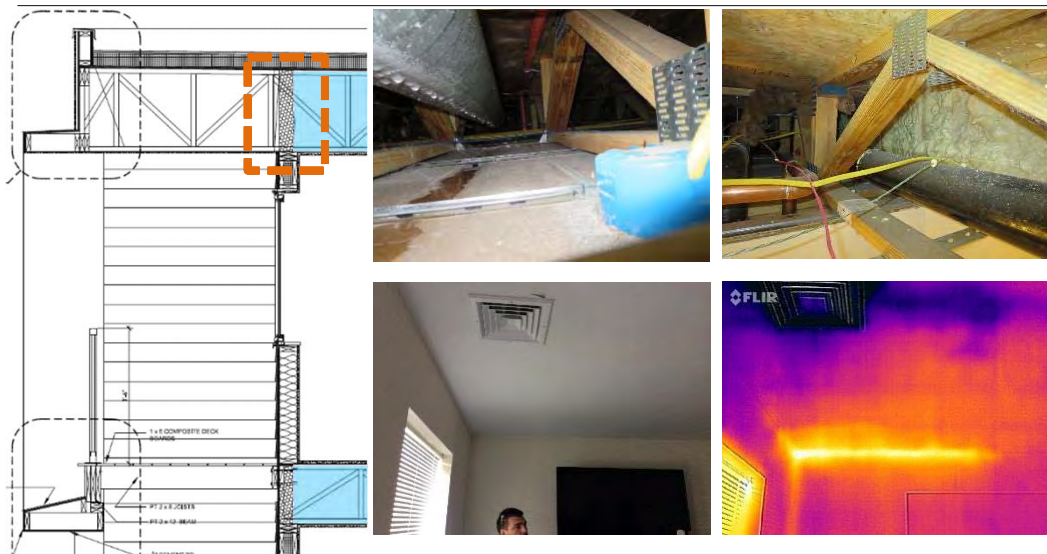

Summer Camp XXV: Multifamily Humidity Control Problems: Muggy Mayhem

37
© buildingscience.com

37

Open Web Floor Truss Air Leaks

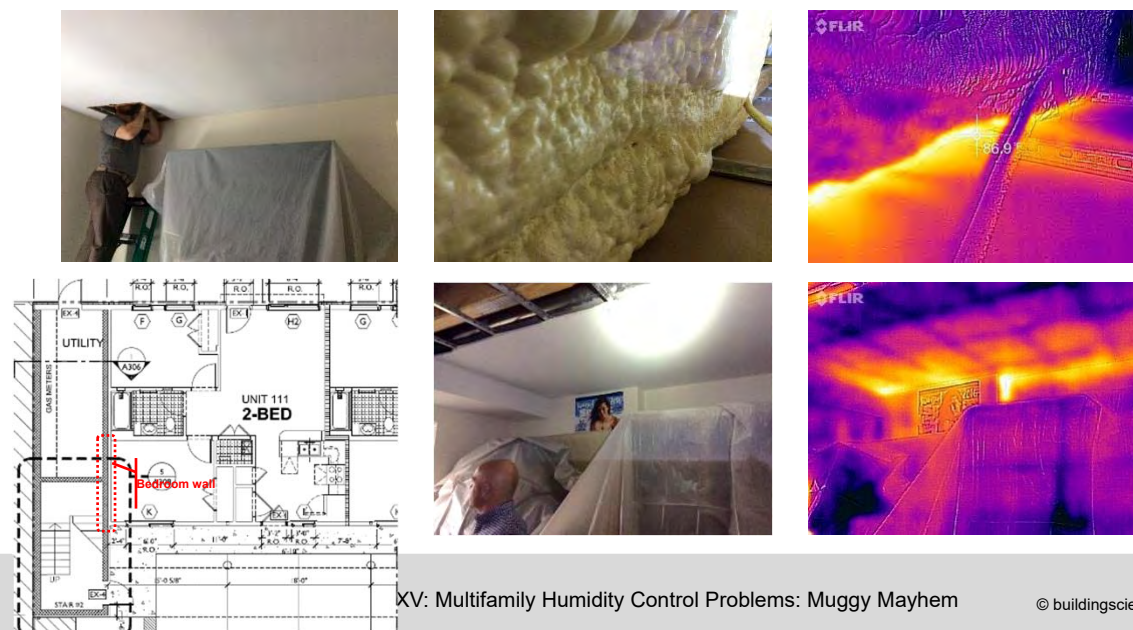

XV: Multifamily Humidity Control Problems: Muggy Mayhem

38
© buildingscience.com

38

Lineset Roof “Doghouse” Penetrations

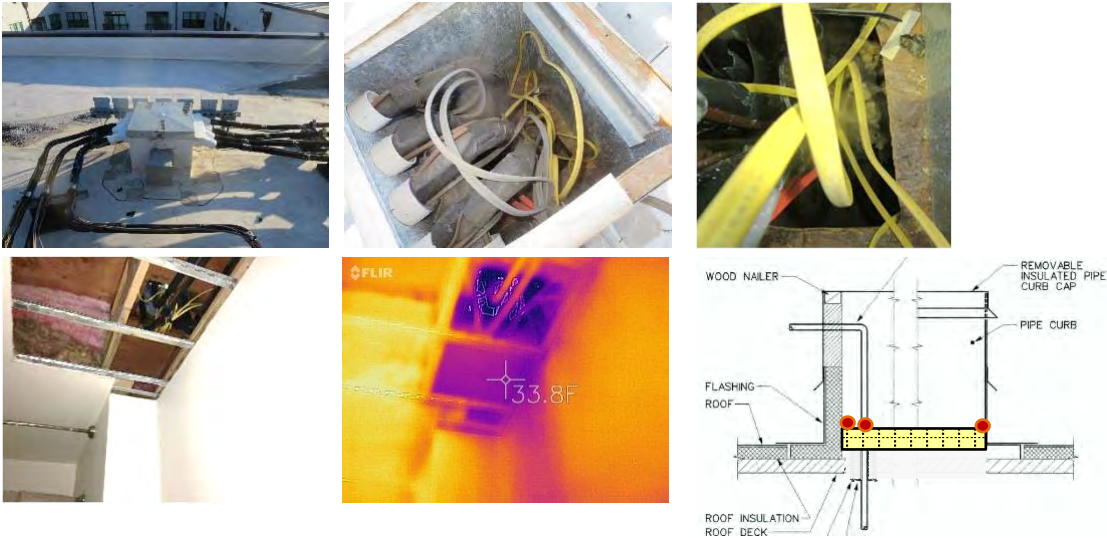

Summer Camp XXV: Multifamily Humidity Control Problems: Muggy Mayhem

39
© buildingscience.com

39

“Intentional Holes” (Microwave Exhaust)



Summer Camp XXV: Multifamily Humidity Control Problems: Muggy Mayhem

40
© buildingscience.com

40

Why the “Halo of Mold”?



- Cold air is driest air
- But when AC turns off...
- Also, uninsulated boot in vented attic dripping

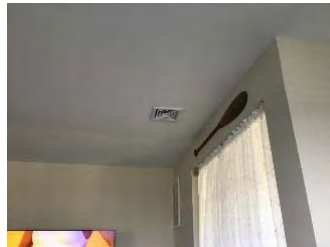

Mechanical Systems and Dehumidification

Mechanicals Overview

- Cooling is only dehumidification mechanism available (typically)
- HVAC controlled by temperature not humidity (typically)
- “Incidental dehumidification” from cooling operation
- Problems from underperforming cooling (failing to dehumidify)
- Diagnostic measurements & fixes

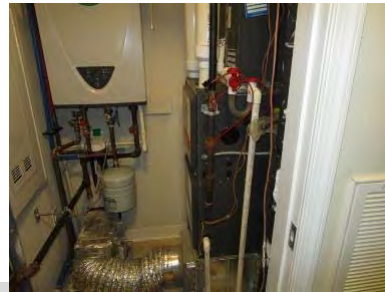

Summer Camp XXV: Multifamily Humidity Control Problems: Muggy Mayhem

43
© buildingscience.com

43

How Do Cooling Systems Work? (Dehumidification)

- Horizontal = temperature
Vertical = moisture
Curve = 100% RH
- First “dry cooling”
- Next dehumidification + dry
- Air coming out of cooling coil ~95% RH
- We want ~50 DP air or drier
- **We need to cool air down to ~50 F or colder to get ~50 DP air**

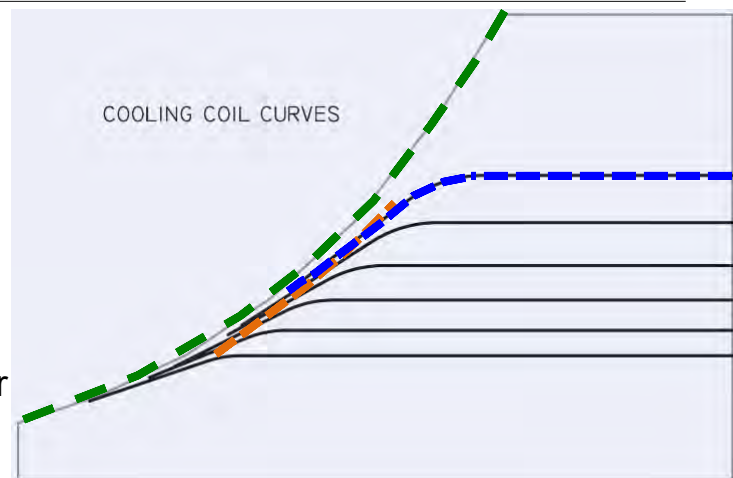

Summer Camp XXV: Multifamily Humidity Control Problems: Muggy Mayhem

44
© buildingscience.com

44

Air Handler Temperature/RH

- Diagnosing humidity control problems
- “Split” (return-supply ΔT) indicates performance
- 18-20 F “split” means good dehumidification
- 50 F supply air great
 - 70 F indoors – 20 F split = 50 F
- 60 F supply air = ~60 F dewpoint
 - ***This system can never achieve 50 dewpoint indoors***



Summer Camp XXV: Multifamily Humidity Control Problems: Muggy Mayhem

45
© buildingscience.com

45

Air Handler Temperature/RH

- 18-20 F “split” means good dehumidification
- Also measure supply vs. return dewpoint
 - Direct measurement of moisture removal
- Suspects:
 - Refrigerant charge problems
 - Airflow problems

System	ΔT	ΔDP	ΔT	ΔDP
1	18.0° F	4.0° F	██████████	███
2	18.0° F	8.0° F	██████████	██████
3	7.0° F	2.0° F	███	██
4				
5				
6	11.0° F	3.0° F	██████	██
7	12.0° F	2.0° F	██████	██
8	11.0° F	1.0° F	██████	

Summer Camp XXV: Multifamily Humidity Control Problems: Muggy Mayhem

46
© buildingscience.com

46

Air Handler Temperature/RH (PTAC)

- PTAC cooling **ON**/fan on:
 $\Delta DP = 13-15F$
- PTAC cooling **OFF**/fan on:
 $\Delta DP = -2 F$
 - PTAC is adding moisture to the room!
- Continuous PTAC fan = terrible dehumidification
- Continuous fan is default PTAC setting

Unit/Condition	ΔT	ΔDP	ΔT	ΔDP
C2-Fan On	2.0° F	-2.0° F		
C2-Cooling On	17.0° F	13.0° F		
D2-Fan On	5.0° F	-2.0° F		
D2-Cooling On	20.0° F	15.0° F		



Summer Camp XXV: Multifamily Humidity Control Problems: Muggy Mayhem

47
© buildingscience.com

47

Cooling Airflows and Dehumidification

- Flow the air “low and slow over the coil” for greater humidity removal
- “CFM per ton” or airflow per unit of cooling
 - (1 ton = 12,000 Btu/hour)
- 400 CFM/ton: “normal” operating condition
- 450 CFM/ton: **efficiency** ↑↑, **humidity removal** ↓↓
 - Used in hot dry climates
- 325-350 CFM/ton: **humidity removal** ↑↑, **efficiency** ↓↓
- Removing moisture costs energy**
- Home Innovation/NAHB research: 245 CFM/ton great dehumidification without coil freeze-up



Summer Camp XXV: Multifamily Humidity Control Problems: Muggy Mayhem

48
© buildingscience.com

48

HVAC System Airflow Settings

- DIP switches & jumpers & and taps (oh my!)
- Installers leave at default
- 2 ton (800 CFM) air handler + 1-½ ton outdoor unit = **530 CFM/ton**

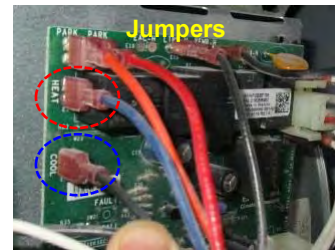
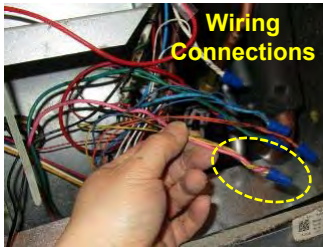
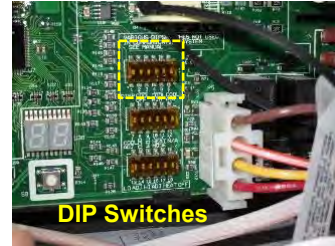
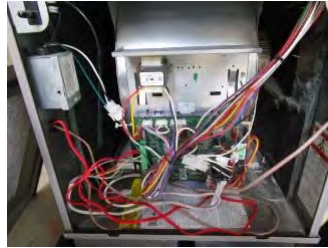

Summer Camp XXV: Multifamily Humidity Control Problems: Muggy Mayhem

49
© buildingscience.com

49

HVAC System Airflow Settings

- “We can’t turn down the airflow: colder ducts means more condensation.”
- Remember—sweaty ducts are inside conditioned space
- Time for math: $Q = 1.07 \cdot \Delta T \cdot \text{CFM}$
- $Q_{\text{before}} = Q_{\text{after}}$
- From 400 CFM/ton → 350 CFM/ton
- Delivery temperature drops by 2 F assuming not change in latent / moisture removal

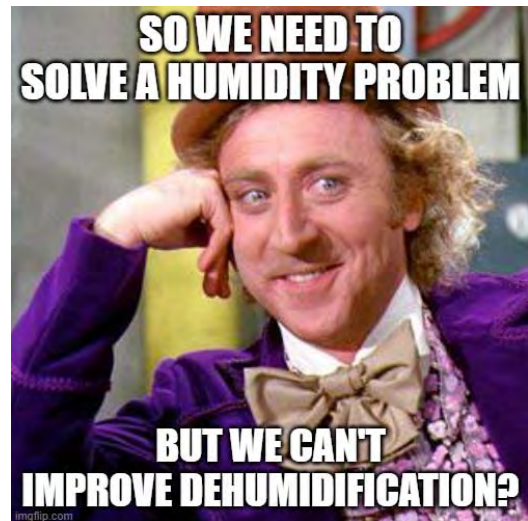

Summer Camp XXV: Multifamily Humidity Control Problems: Muggy Mayhem

50
© buildingscience.com

50

Refrigerant Charge

- AC refrigerant charge – large effect on equipment efficiency, capacity, moisture removal
- Too much or too little = problems
- AC outdoor units “precharged”... for 15 feet of lineset
- Multifamily buildings = longer distances from outdoors to unit

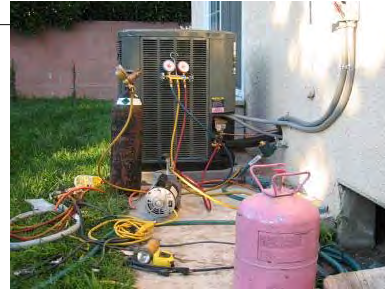

Summer Camp XXV: Multifamily Humidity Control Problems: Muggy Mayhem

51
© buildingscience.com

51

Ductless Heat Pumps (“What About Mini Splits?”)

- Come in smaller sizes
- Modulating good
- BUT still humidity issues
 - Peak load = cold coil, good dehumidification
 - Part load = warm coil, less dehumidification
 - “Dry mode” underwhelming
- Multi-splits/VRFs
 - Don’t modulate the same way as MSHPs
 - Outdoor unit modulation vs. indoor unit sizing limitations



Summer Camp XXV: Multifamily Humidity Control Problems: Muggy Mayhem

52
© buildingscience.com

52

Variable Speed Asian Air Handlers

- Part load conditions: $\Delta T=9$ F (minimal dehumidification)
- Force into “high load” (turn setpoint way down): $\Delta T=20$ F
- Rooftop unit modulates, expansion valve modulates
- “Dry mode” = low fan speed: a bit helpful... but not much



Summer Camp XXV: Multifamily Humidity Control Problems: Muggy Mayhem

© buildingscience.com

53

Occupant Operation of Mechanicals

- Thermostat on-off operation
- Swapping windows open vs. closed up
- Very cold setpoints → colder duct surfaces
 - Delivery air temperature & longer runtimes
- “FAN ON” instead of “FAN AUTO”
 - Turns AC into “re-humidification” system
- Ventilation fans left on 24/7/365



Summer Camp XXV: Multifamily Humidity Control Problems: Muggy Mayhem

54
© buildingscience.com

54

Part-Load Humidity and Dehumidification

- Better enclosures/shells: less cooling load
 - Windows, shading, insulation levels, airtightness
- Less runtime → less dehumidification
 - “Shoulder” seasons often worst
- Oversized cooling equipment → poor dehumidification
 - Two stage/multi speed helps, but...
- High-efficiency HVAC → worse dehumidification
- Adding supplemental dehumidification might be more and more necessary?

55

Mechanical Dehumidification Solutions

56

Adding Dehumidification (Closet AHU)

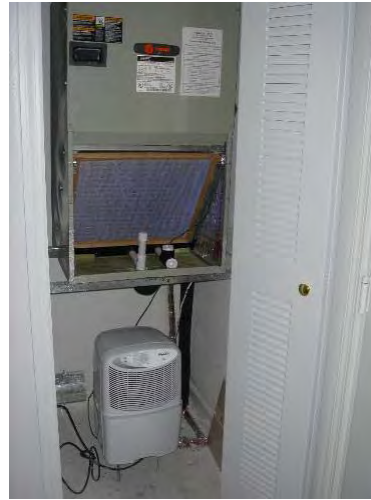
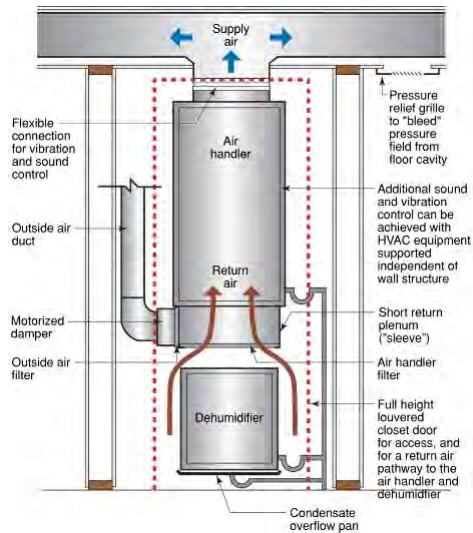

Summer Camp XXV: Multifamily Humidity Control Problems: Muggy Mayhem

57
© buildingscience.com

57

Wall-Mounted Dehumidifier

- Power and drain connections required

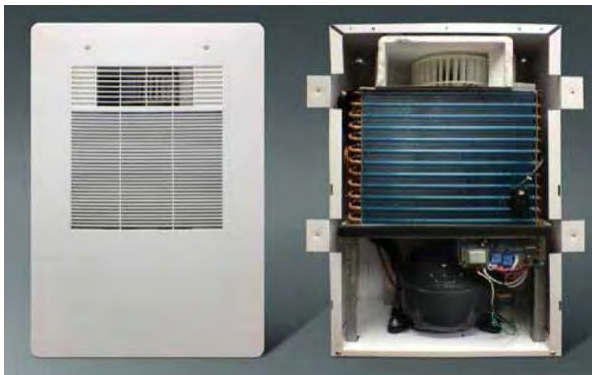

Front Cover



Internal Components

Summer Camp XXV: Multifamily Humidity Control Problems: Muggy Mayhem

58
© buildingscience.com

58

Ducted Dehumidifier (Integrated with HVAC)

- Ducted high efficiency units
- Corridor dehumidification, “filters” to apartments?
- Dehumidify outside supply air option

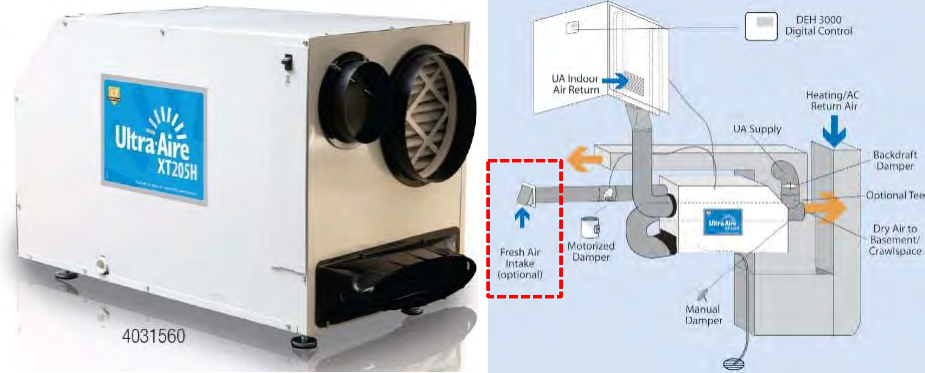

Summer Camp XXV: Multifamily Humidity Control Problems: Muggy Mayhem

59
© buildingscience.com

59

Make-Up Air and Dedicated Outside Air

- “MUA” or “DOAS”
- Precondition ventilation supply air, addressing heating, cooling, dehumidification
- Separates heating/cooling of space from ventilation loads
- Supply ventilation @ **drier** than interior target
- Capital equipment cost
- Complexity (not for residential-level technicians)

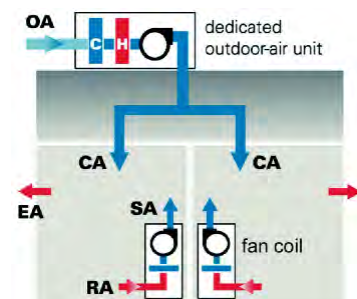

Summer Camp XXV: Multifamily Humidity Control Problems: Muggy Mayhem

60
© buildingscience.com

60

Calculating Humidity Loads

- 65 F DP outside air
 - 80 F/60% RH
- 300 CFM = 5.5 pints/hr = 132 pints/day
- Residential dehumidifier 30-50 pints/day
- Cooling system deals with some moisture—e.g., half?

Munters PsychoApp™

Alt, ft: 0

Entering		Leaving	
80.00	°F db	72.00	°F db
60.40	%RH	55.00	%RH

SCFM: 300

Results	
Total	-8,681 Btuh 0 Tons
Sensible	-2,592 Btuh
Latent	-6,089 Btuh
Moisture	-5.51 lb/hr



61

Calculating Humidity Loads



75 CFM @ 65 F DP



33 pints/day

62

Case Studies

63

Window Replacement

- Hot humid, uninsulated block 1950's construction
- Replaced windows w. vinyl double low-E
- AC remained same
- Mold growth on HVAC, ceiling, floors
- Reduction in load → less AC runtime → less dehumidification



64

Uncontrolled CFIS Ventilation

- Outside air (OA) duct to return
- Bath exhausts (“semi-balanced”)
- No motorized damper on OA duct
- Peak summer load = draws more OA
- Depressurization → duct sucks OA with air handler off

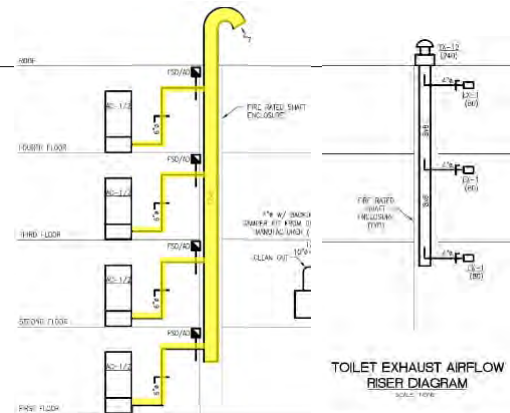

Summer Camp XXV: Multifamily Humidity Control Problems: Muggy Mayhem

65
© buildingscience.com

65

All-Exhaust Ventilation & Tight Construction

- ZIP wall sheathing, spray foam roof
- All guest rooms constant exhaust fan operation (lo/hi)
- No make-up air system
- -10 Pascals typical; 3000 CFM of exhaust
- -15 Pascals with kitchen exhaust fan on
- Fireplace no longer drafts



Summer Camp XXV: Multifamily Humidity Control Problems: Muggy Mayhem

66
© buildingscience.com

66

VRF Space Conditioning

- 70%+ RH in summer
- Good 'split'/ΔT at heads
- BUT heads running in constant fan mode
- Still oversized
- Setting for fan cycling



Function	Settings	Mode No.	Setting No.	Initial setting (Factory setting) — Not available											
				4-WAY cassette	Ceiling suspended	Wall mounted	Ceiling concealed	Floor standing	FLA (DRP/BKZ)	SLZ (AA/VALVAG)	PCA (RP/KAG)	PCB (RP/HAG)	PMA (RP/BAUKAL)	PENL (RP/JMLC)	PEA (RP/GAD)
Fan speed during the heating thermostat is OFF	Extra low		1	●	●	●	●	●	●	●	●	●	●	●	●
	Stop	26	12												
Fan speed during the cooling thermostat is OFF	Setting fan speed		13										40/500		
	Stop	27	12	●	●	●	●	●	●	●	●	●	●	●	●

Summer Camp XXV: Multifamily Humidity Control Problems: Muggy Mayhem

67
© buildingscience.com

67

“How Much Exhaust Flow?”

- ΔP ≈ -12 Pa across entire building
- Rooftop unit supply vs. exhaust close to balanced
- Add in all unit exhaust fans 24/7/365

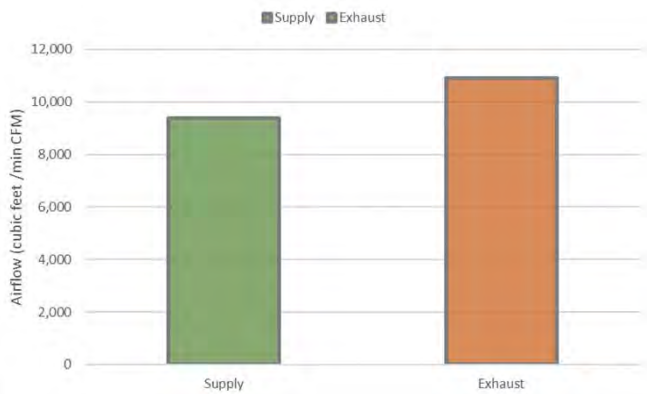

Summer Camp XXV: Multifamily Humidity Control Problems: Muggy Mayhem

68
© buildingscience.com

68

“How Much Exhaust Flow?”

- $\Delta P \approx -12$ Pa across entire building
- Rooftop unit supply vs. exhaust close to balanced
- Add in all unit exhaust fans 24/7/365

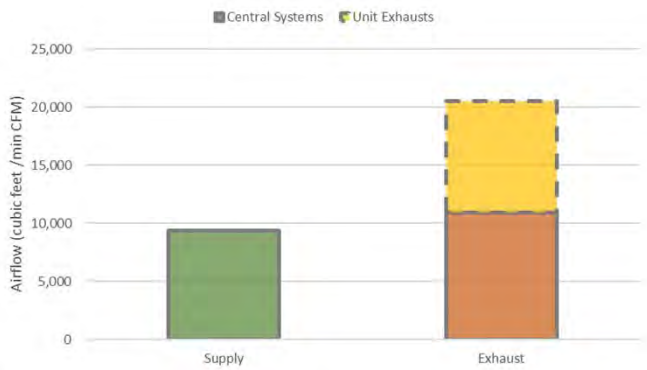

Summer Camp XXV: Multifamily Humidity Control Problems: Muggy Mayhem

“How Much Exhaust Flow?”

- Reducing exhaust airflows
- Changing exhaust risers to supply
- New rooftop MUA units

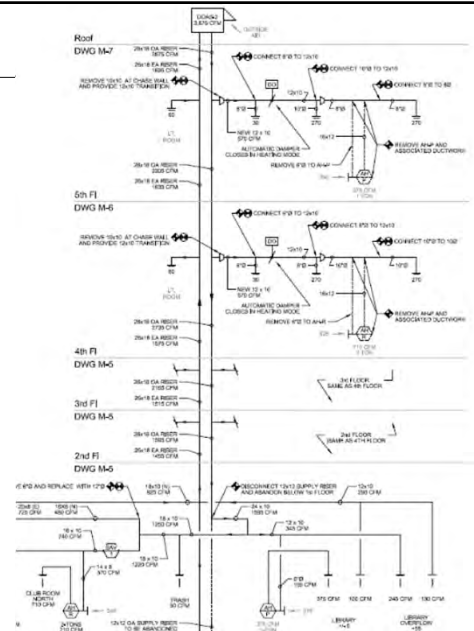

Summer Camp XXV: Multifamily Humidity Control Problems: Muggy Mayhem

Conclusions & Action Items

71

Pitfalls to Watch Out For

- Untreated outdoor air
 - Ventilation/overventilation (more summer air = more moisture)
 - Uncontrolled air leakage (especially “induced infiltration”)
- Poorly dehumidifying cooling equipment
 - Oversized units—better insulation & windows
 - Poor dehumidification setup (split measurement, CFM/ton, refrigerant charge)
- Occupant behavior
 - On-off operation, swapping windows open vs. closed up, very cold setpoints
- Problems often additive—“perfect storm”
- We used to get away with marginal situations

72

Recommendations/Action Items

- Keep building good buildings! (with good equipment)
- Pay attention to ventilation rates/flows
 - More airflow, more problems
- Balanced ventilation >> exhaust only; HRV/ERV best
- Specify 350 CFM/ton and verify (AHU settings)
- Remaining air leaks can still cause problems
- Preplan dehumidifier connections?
- If problems occur:
 - Verify list above
 - Field measurement of temperature 'split'—is AC dehumidifying?
 - Add mechanical dehumidification?

73

Questions?

Kohta Ueno
kohta (at sign) buildingscience dot com

This presentation will be available at <http://buildingscience.com/past-events>

74

Document Resources

- Building Science Digest 110: HVAC in Multifamily Buildings
<http://www.buildingscience.com/documents/digests/bsd-110-hvac-in-multifamily-buildings>
- Building Science Insight 012: Balancing Act - Exhaust-Only Ventilation Does Not Work
<http://buildingscience.com/documents/building-science-insights/bsi-012-balancing-act-exhaust-only-ventilation-does-not-work>
- Information Sheet 611: Balanced Ventilation Systems (HRVs and ERVs)
<http://buildingscience.com/documents/information-sheets/info-611-balanced-ventilation-systems>
- Information Sheet 620: Supplemental Humidity Control
<http://buildingscience.com/documents/information-sheets/information-sheet-supplemental-humidity-control>
- Information Sheet 607: Refrigeration System Installation and Startup Procedures, and AC Equipment Efficiency
<https://buildingscience.com/documents/information-sheets/refrigeration-system-installation-startup-procedures>
- Information Sheet 608: What's the Big Deal About Refrigerant Charge—Why Should the Builder or Homeowner Care?
<https://buildingscience.com/documents/information-sheets/refrigerant-charge>
- Research Report 0203: Relative Humidity
<http://www.buildingscience.com/documents/reports/rr-0203-relative-humidity/view>
- Building America Report 0219: Residential Dehumidification Systems Research for Hot-Humid Climates
<https://www.buildingscience.com/documents/bareports/ba-0219-residential-dehumidifications-systems-research-hot-humid-climates/view>
- Controlling Humidity in Warm Climates, *Journal of Light Construction*, May 2018
https://www.jlconline.com/how-to/hvac/controlling-humidity-in-warm-climates_o