



# Chasing HVAC Unicorns

*The Hunt for Mythical Systems,  
Fantastical Designs  
& Legendary Tradespeople*



*Only the True in  
Heart Shall Be  
Found Victorious*

KIMBERLY LLEWELLYN  
Mitsubishi Electric Trane US

BRYAN ORR  
Kalos Services and HVAC School

# This struggle is an ancient one...

The architect should be equipped with knowledge of many branches of study and varied kinds of learning,...

**This knowledge is the child of practice and theory.**

Practice is the continuous and regular exercise of employment where manual work is done with any necessary material according to the design of a drawing.

Theory, on the other hand is the ability to demonstrate and explain. It follows, that **...those who relied only upon theories and scholarship were obviously hunting the shadow, not the substance.**"





# THE QUEST IS CLEAR

Comfort

Health

Reliability

Serviceability

Efficiency

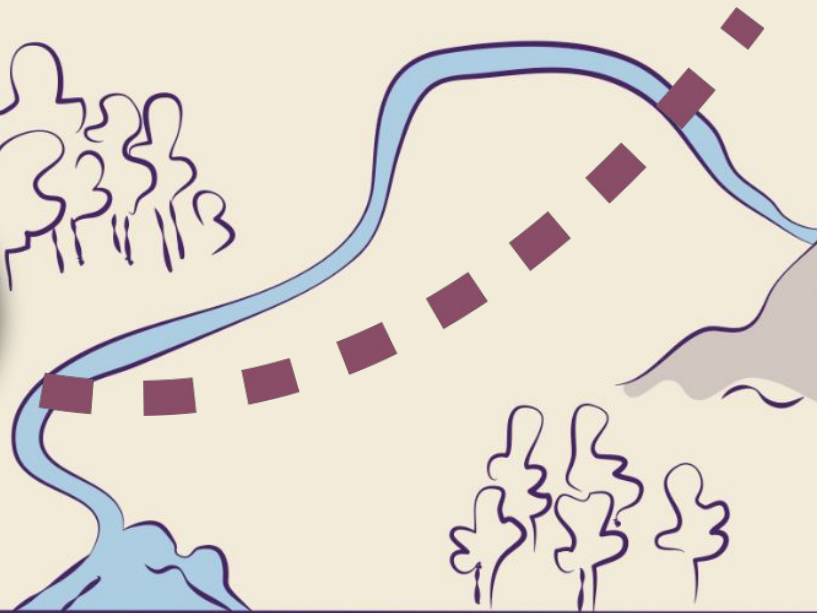



# Understanding mythical systems



**Chasing HVAC  
Unicorns**

*The Hunt for Mythical Systems,  
Fantastical Designs  
& Legendary Tradespeople*





# The Infinitely Variable HP

- **Myth:** Variable-capacity heat pumps (VHCPs) have a nearly infinite range of operation
- **Truth:** VCHPs can modulate many different components, but they have a minimum and maximum compressor and blower speed
- **VCHPs** do **NOT** have a fixed sensible heat factor (SHF)!
- **VCHPs** can prioritize efficiency OR dehumidification, **not both at once**

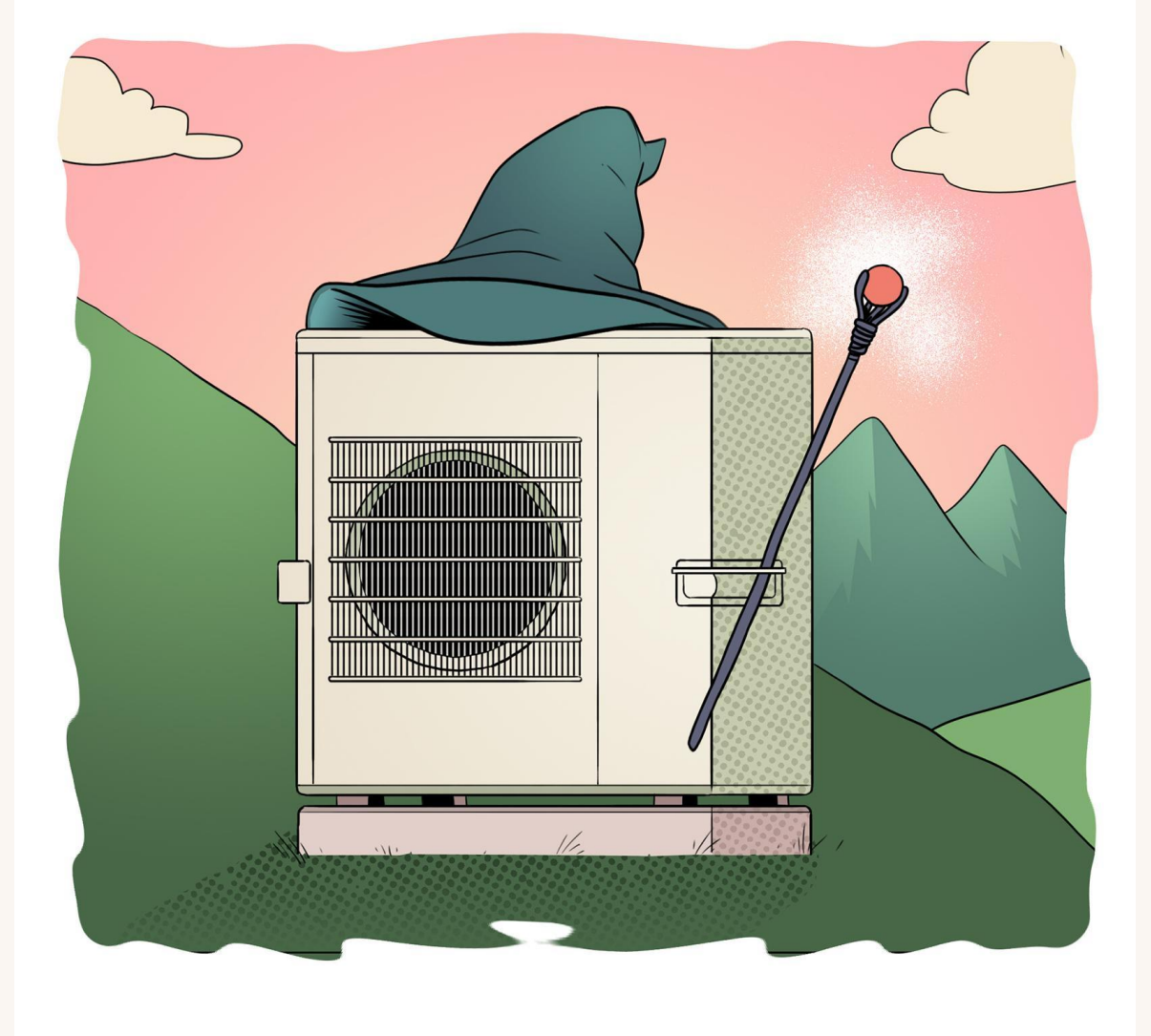

# The Infinitely Variable HP

Man J LOAD @ 90° F ~11,000 Btu/h

11,000 Btu/h Design Load



12k  
BTU min

3C30 CAPACITY RANGE

28k  
BTU max

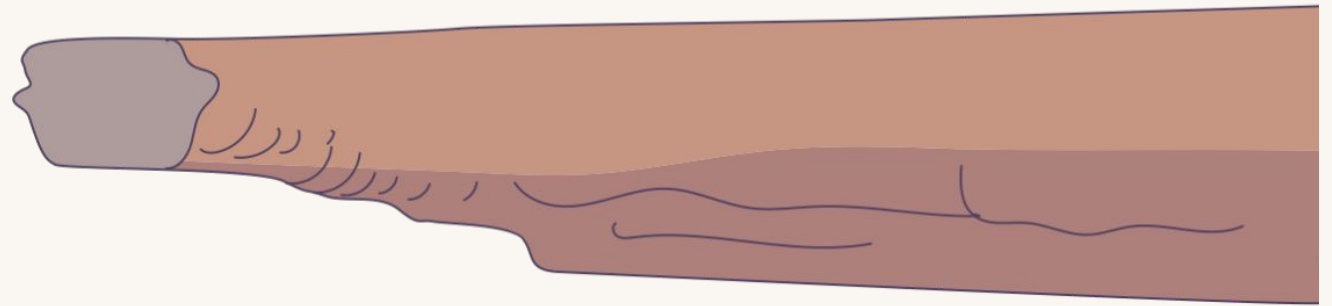



# The Infinitely Variable HP

This is a load calculation

Subtotals for structure:	12,118	0	21,350	21,350
People	4	800	920	1,720
Equipment	0	448	1,310	1,758
Lighting	3807		12,982	12,982
Ductwork	0	0	0	0
Infiltration Winter CFM 62 Summer CFM 62	3,759	1,341	958	2,299
Ventilation Winter CFM 336 Summer CFM 336	2,845	7,247	724	7,971
Exhaust Winter CFM 336 Summer CFM 336				
Humidification (Winter) 17,05 gal/day	6,252	0	0	0
<b>TOTAL BUILDING LOAD</b>	<b>24,974</b>	<b>9,836</b>	<b>38,244</b>	<b>48,080</b>

THIS IS THE HP WHOSE 2<sup>ND</sup>  
COMPRESSOR JUST FAILED

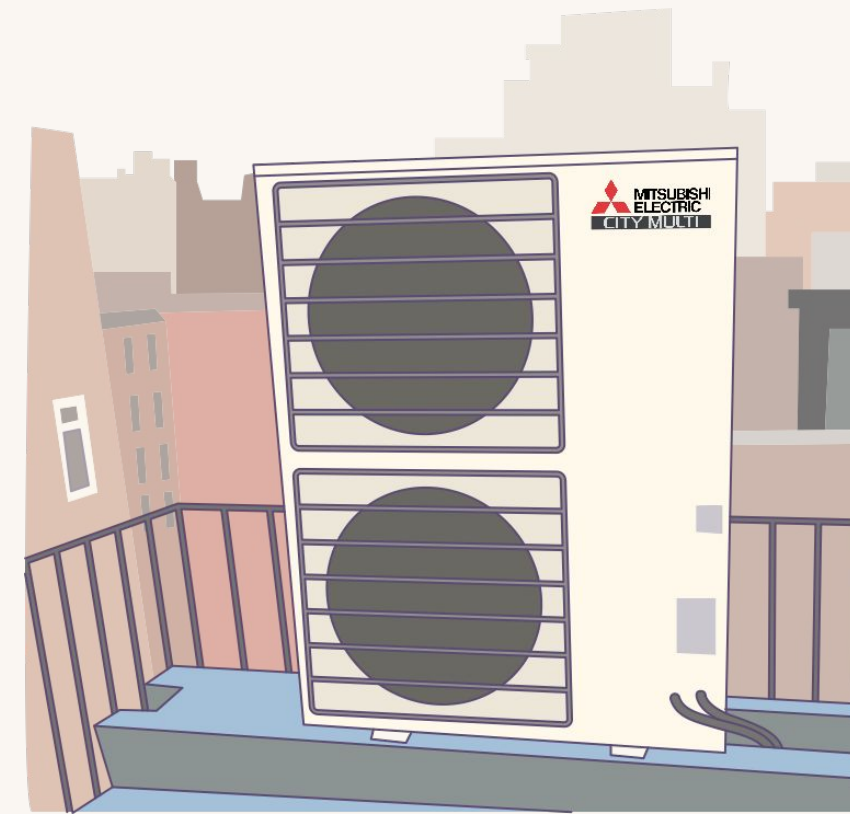

## CHECK FIGURES

Total Building Supply CFM	1,706
Square ft. of Room Area	3,806
Volume (ft <sup>3</sup> )	37,283
CFM Per Square ft.	0.448
Square ft. Per Ton.	950

# Reality Bites



*Single Stage  
Equipment*



*Leaky Structure*



*Variable Capacity  
Equipment*

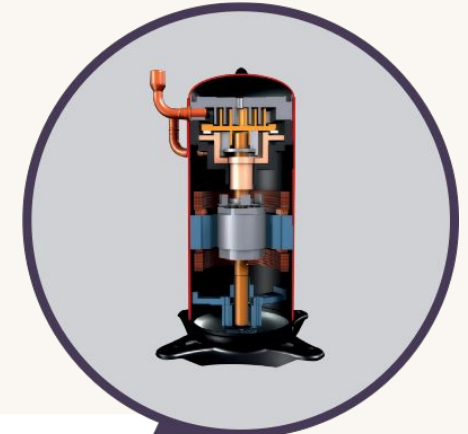

*Tight Energy Efficient Structure*



# Mega-SEER & Dehumidification

**MYTH:** A BTU is a BTU

**Truth:** Latent BTUs are more costly to remove because they require a higher compression ratio

**Mega-SEER** systems are optimized for efficiency and will move more sensible BTUs with a higher evaporator temperature and lower compression ratio.

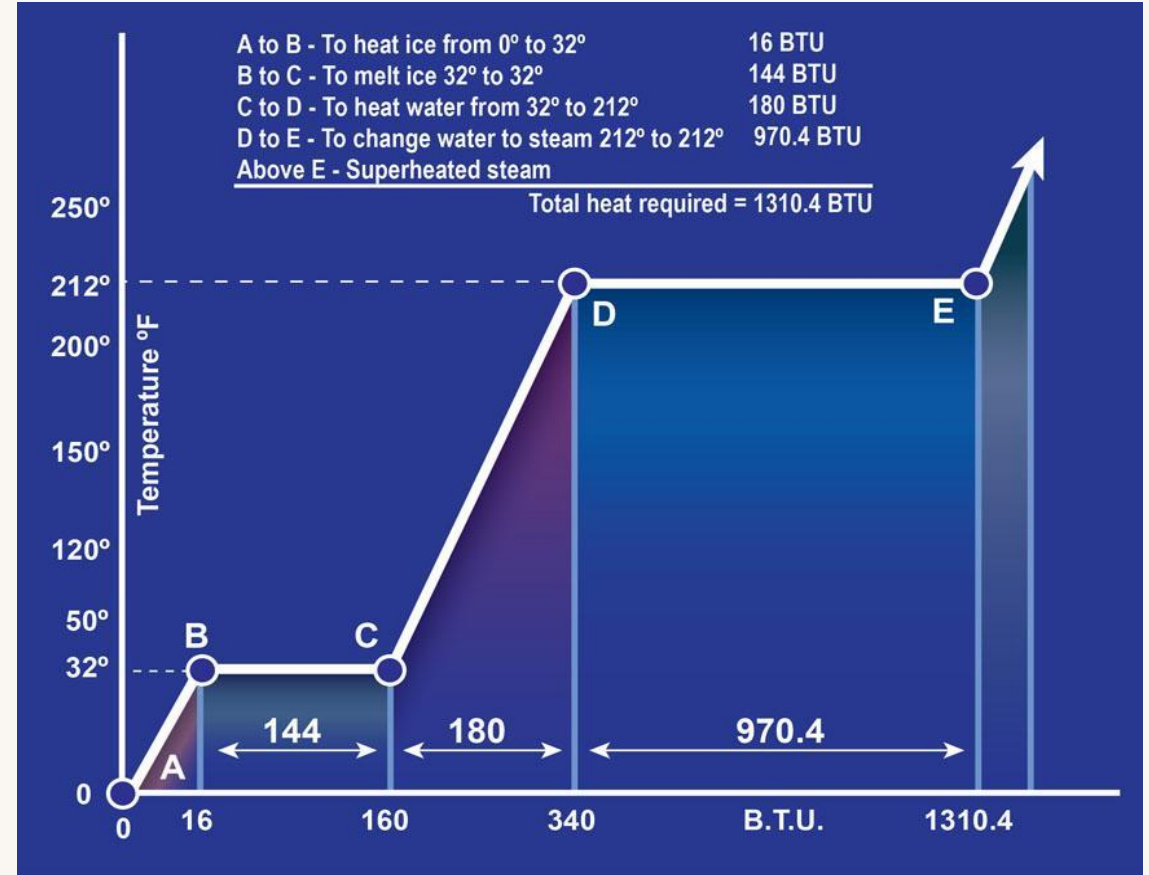

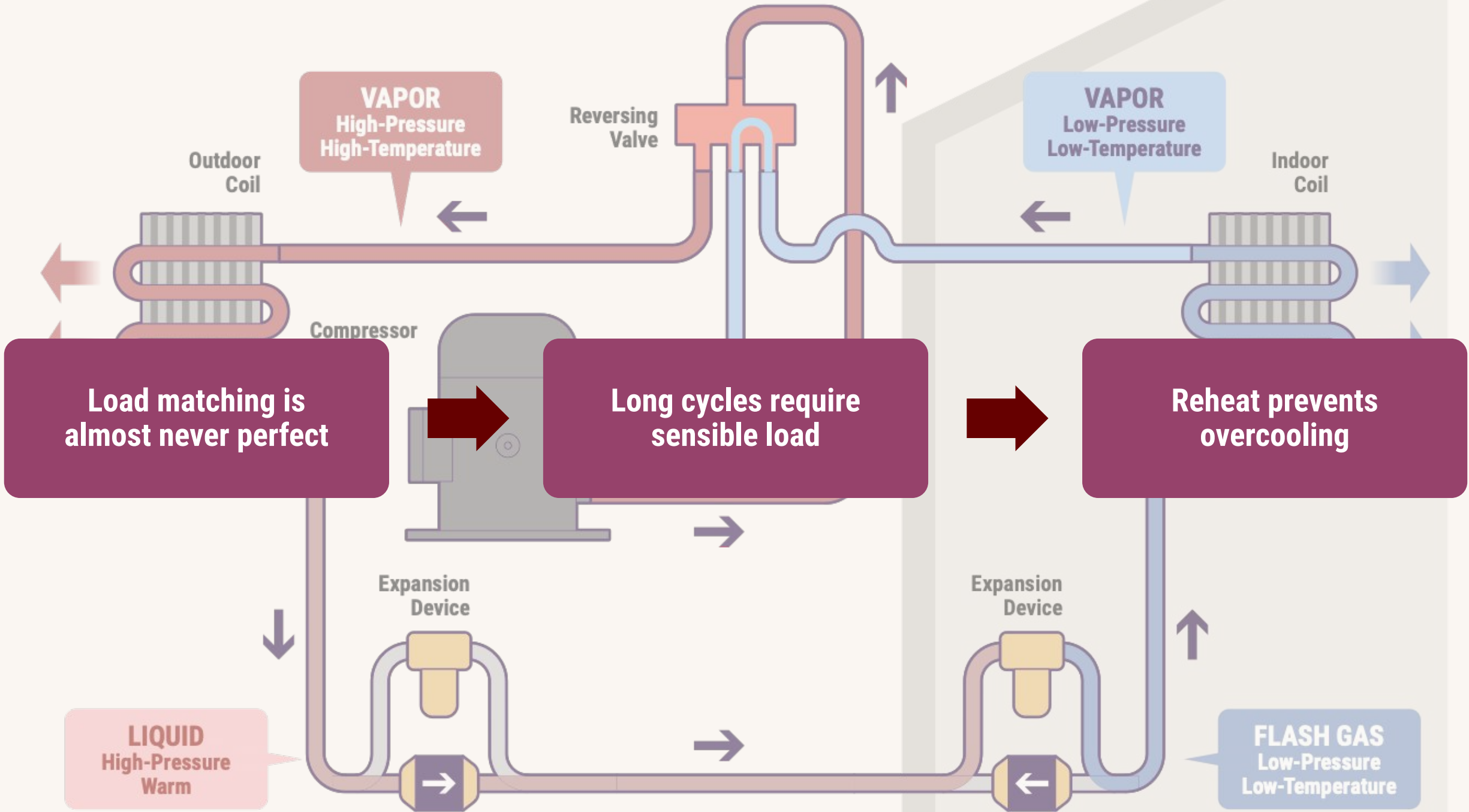



# Fountain of Youth

“Wherever I have a water source heat pump have no issues controlling humidity. Factory reheat is cheap and simple. There aren’t any problems controlling humidity in CZ1 when you have a condenser water connection. That is why the wealthy in Naples don’t have any of these humidity or mech-vent issues. They have cool-heat-dehumidify modes connected to cooling towers. Life is good.”

RICK SIMS



# ...or if you're Robert Bean, you say it like this:

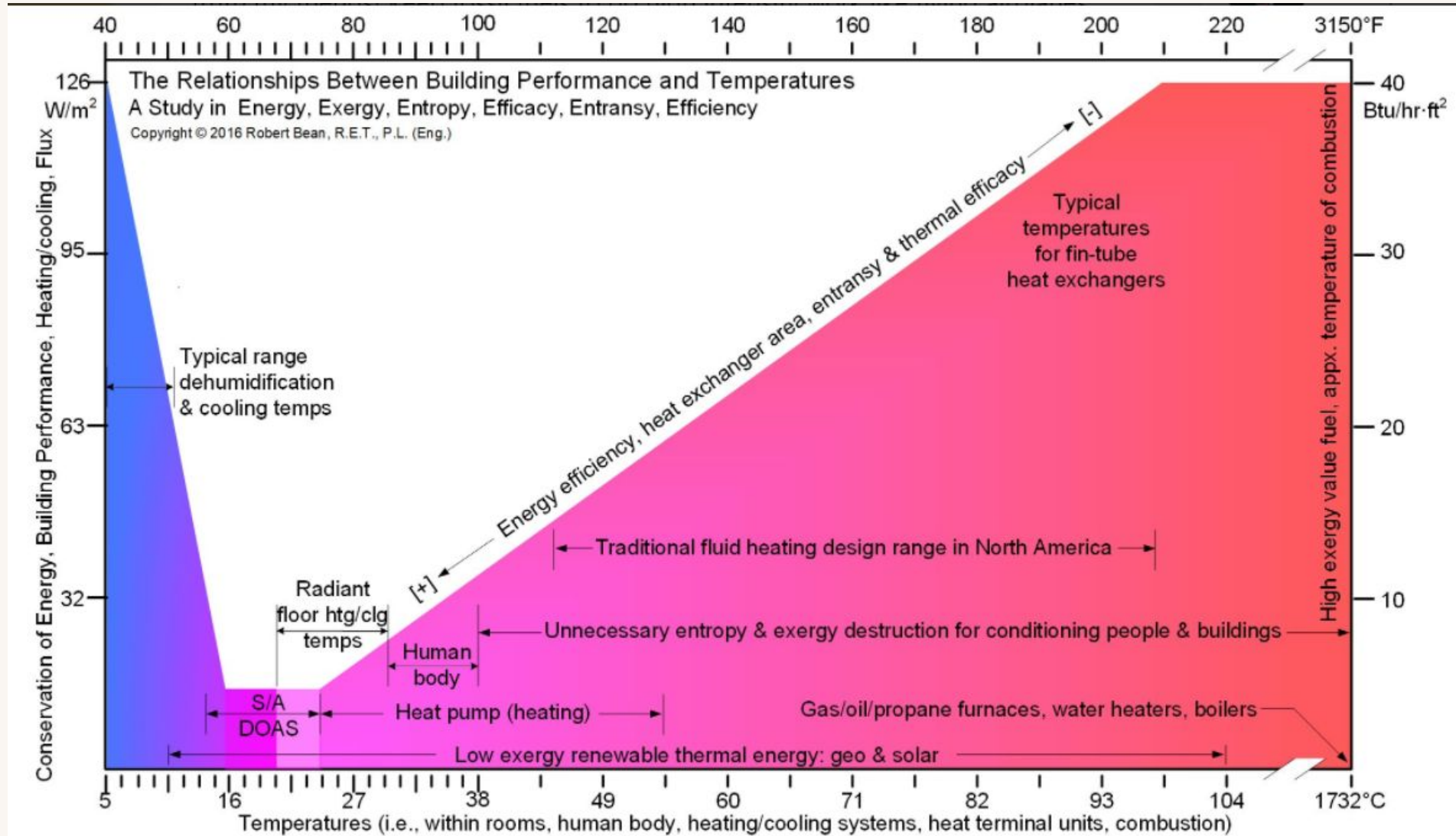

# We're often chasing numbers we don't understand

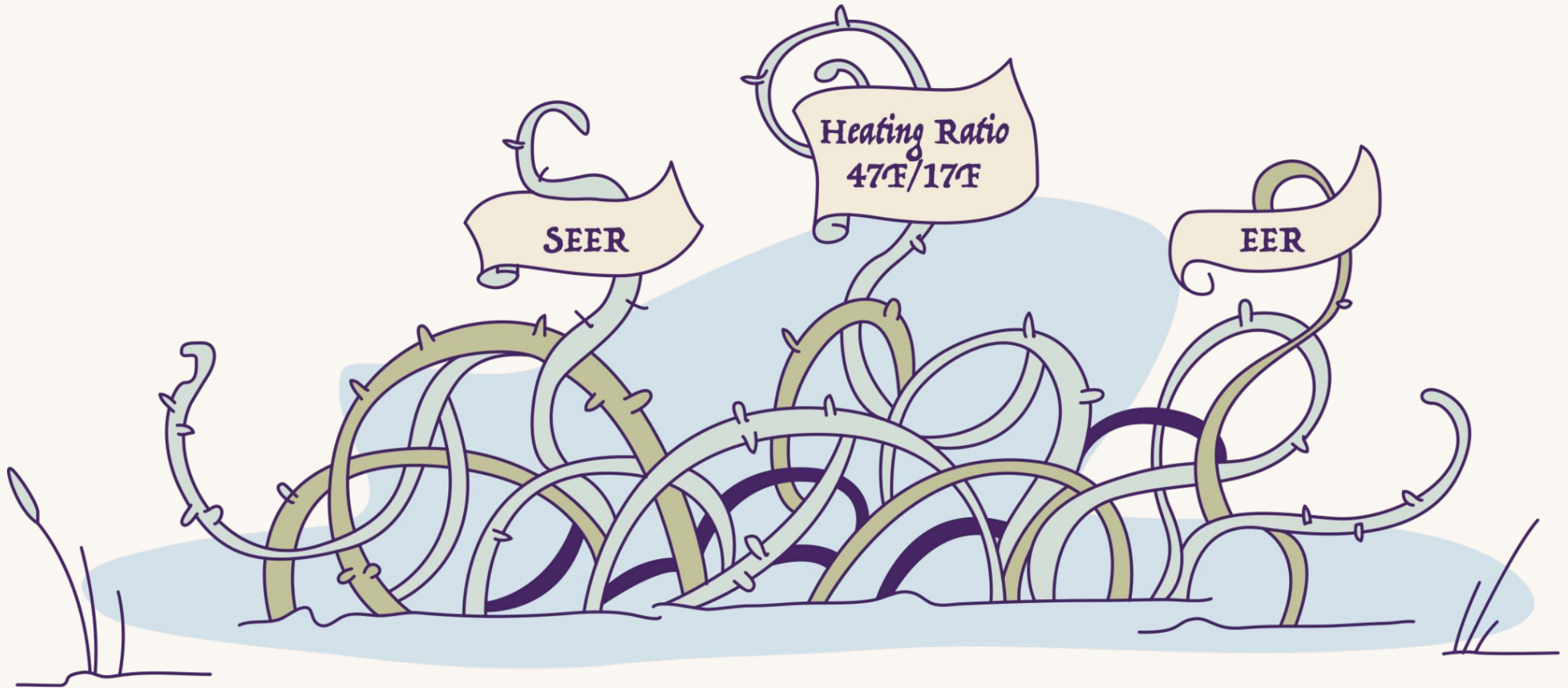



# The Self-commissioning OA Supply Air Duct

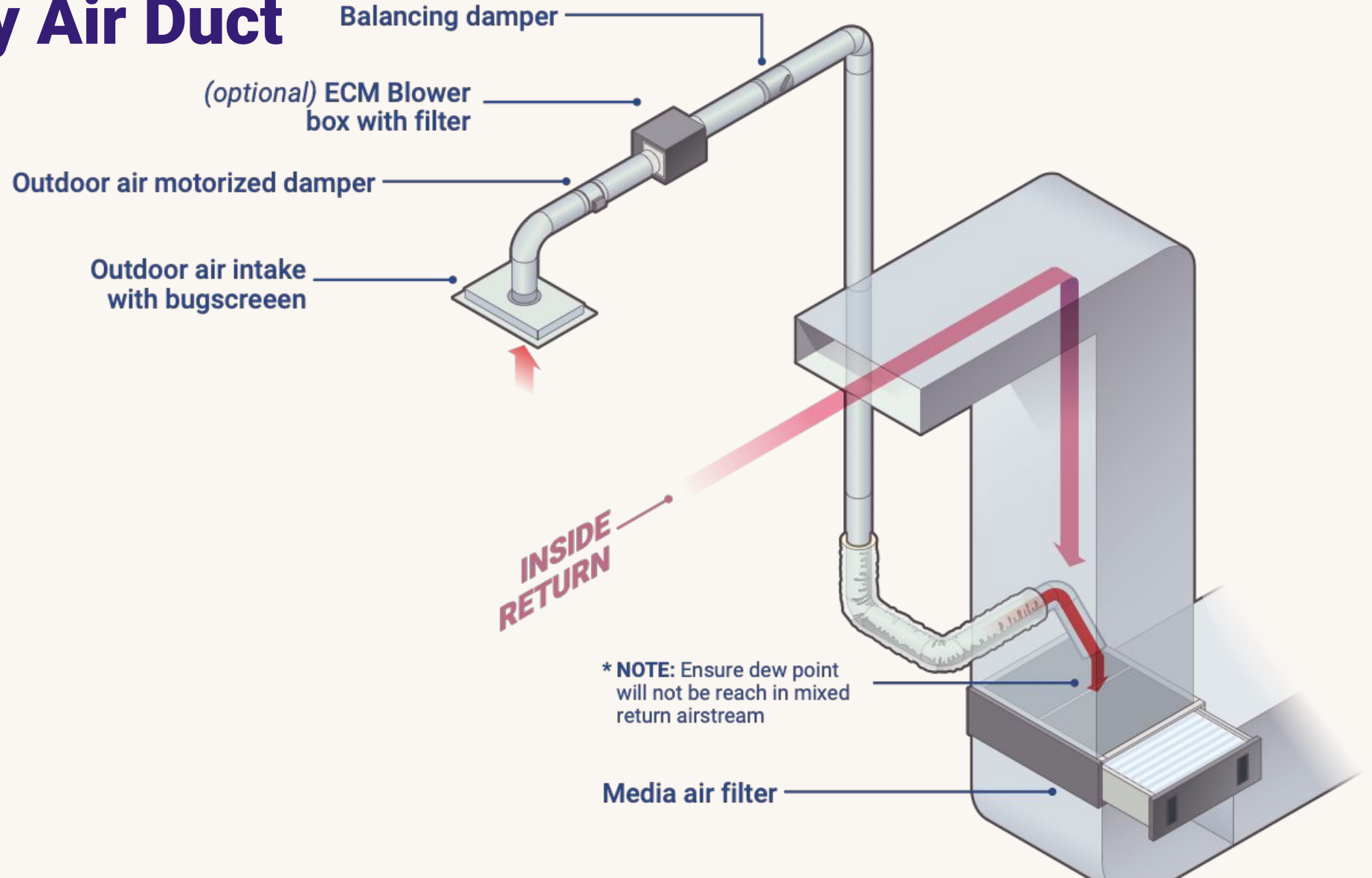

# Static Pressure Probes vs Pitot



Static pressure has closed ends and holes on the side.

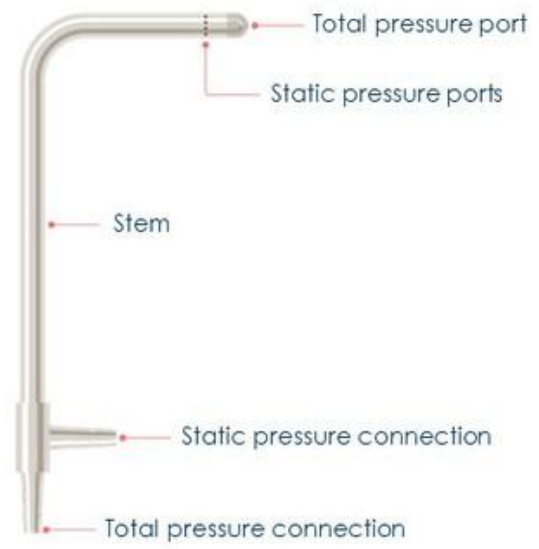

Pitot has a tube in tube and measures total pressure, static and velocity pressure depending on how it's connected.

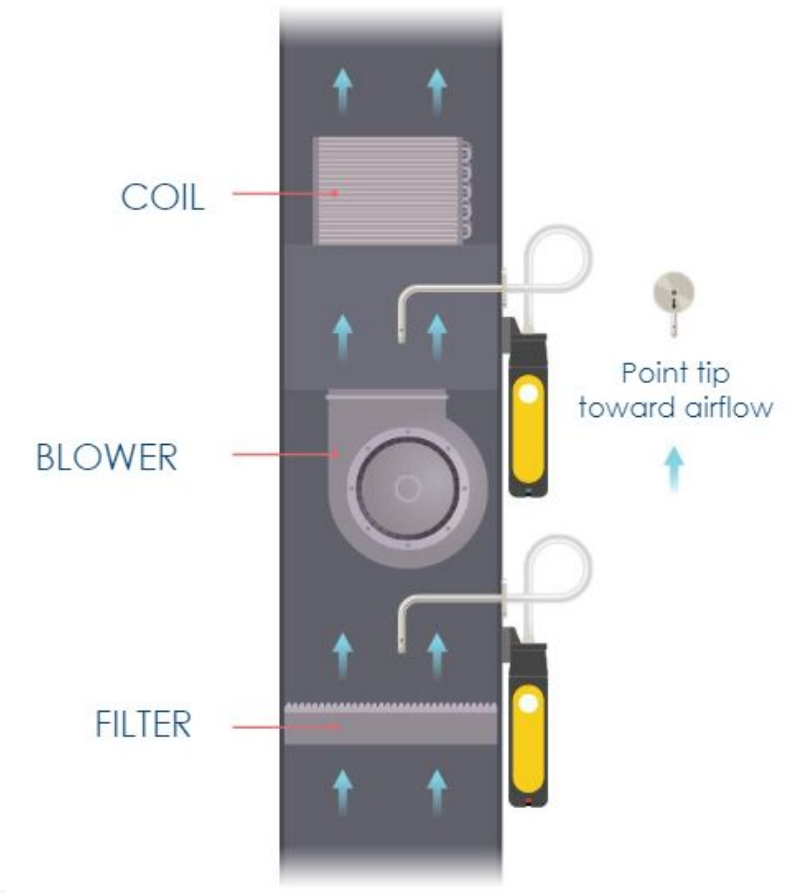

# THE SELF-COMMISSIONING OA SUPPLY AIR DUCT





# Demand Ventilation Control of Destiny



# The Discerning Gravity Damper

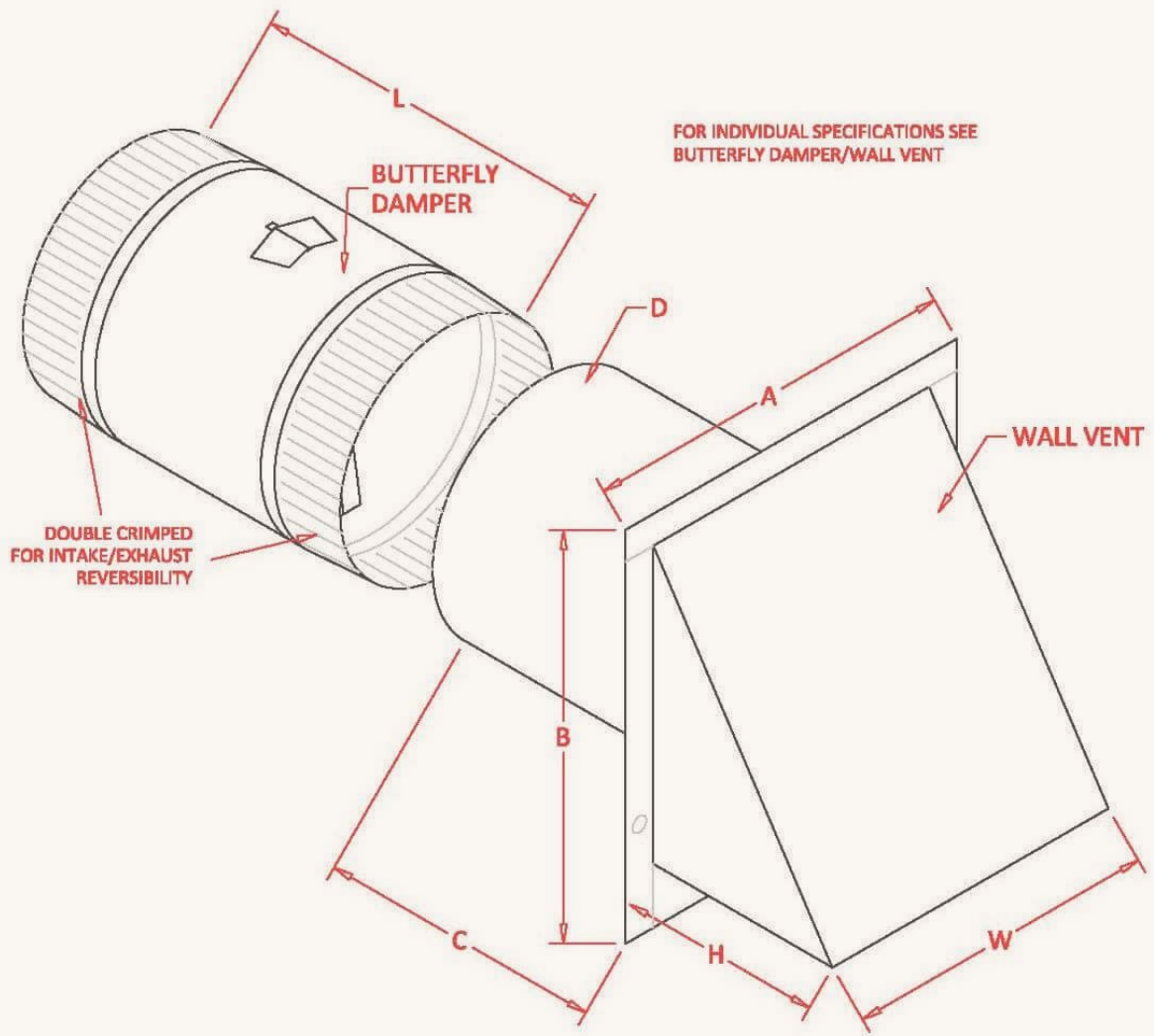





**Mythical Systems  
The Silver  
Bullet**





**INFILTRATION  
(CONVECTIVE GAINS**



**RADIANT  
HEAT**

# ...Abraca-ductless

- Noiseless pumps
- Gravity defying drains
- No access necessary
- Infinitely variable with fixed SHF

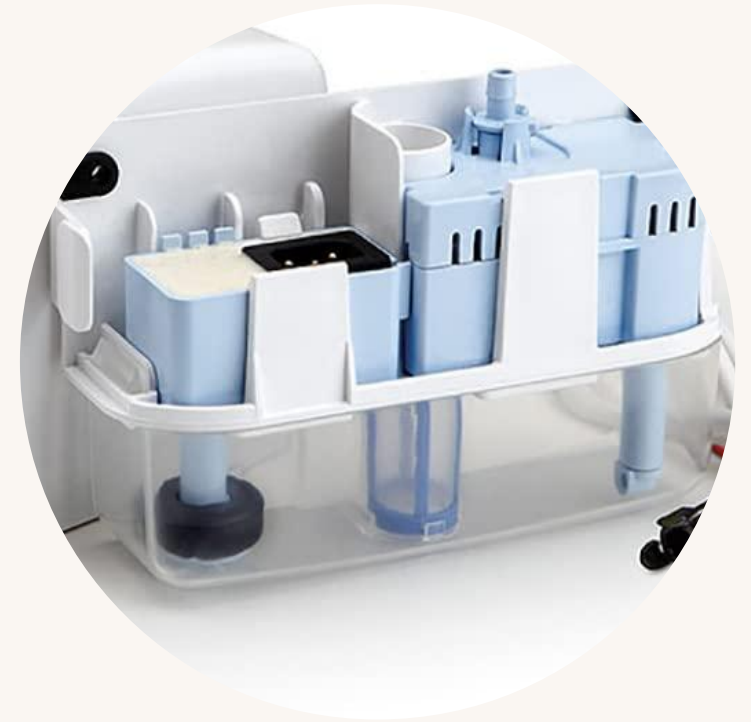

*Understanding mythical systems*



*Mapping location & access*



*Legendary tradespeople forge the path*



*Confronting the liability slope*

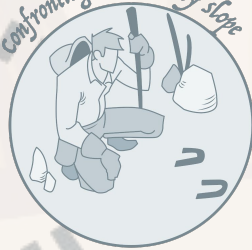

*Communicating respectfully*



# Mapping location & access



**Chasing HVAC  
Unicorns**

*The Hunt for Mythical Systems,  
Fantastical Designs  
& Legendary Tradespeople*







**Fantastical Designs  
8000 ft<sup>2</sup> & no room for ducts**



# THE WRINKLE IN TIME AIR DUCT SYSTEM

Long runs

No space

Multiple bends

Vented Attics

Envelope Issues... Works Great

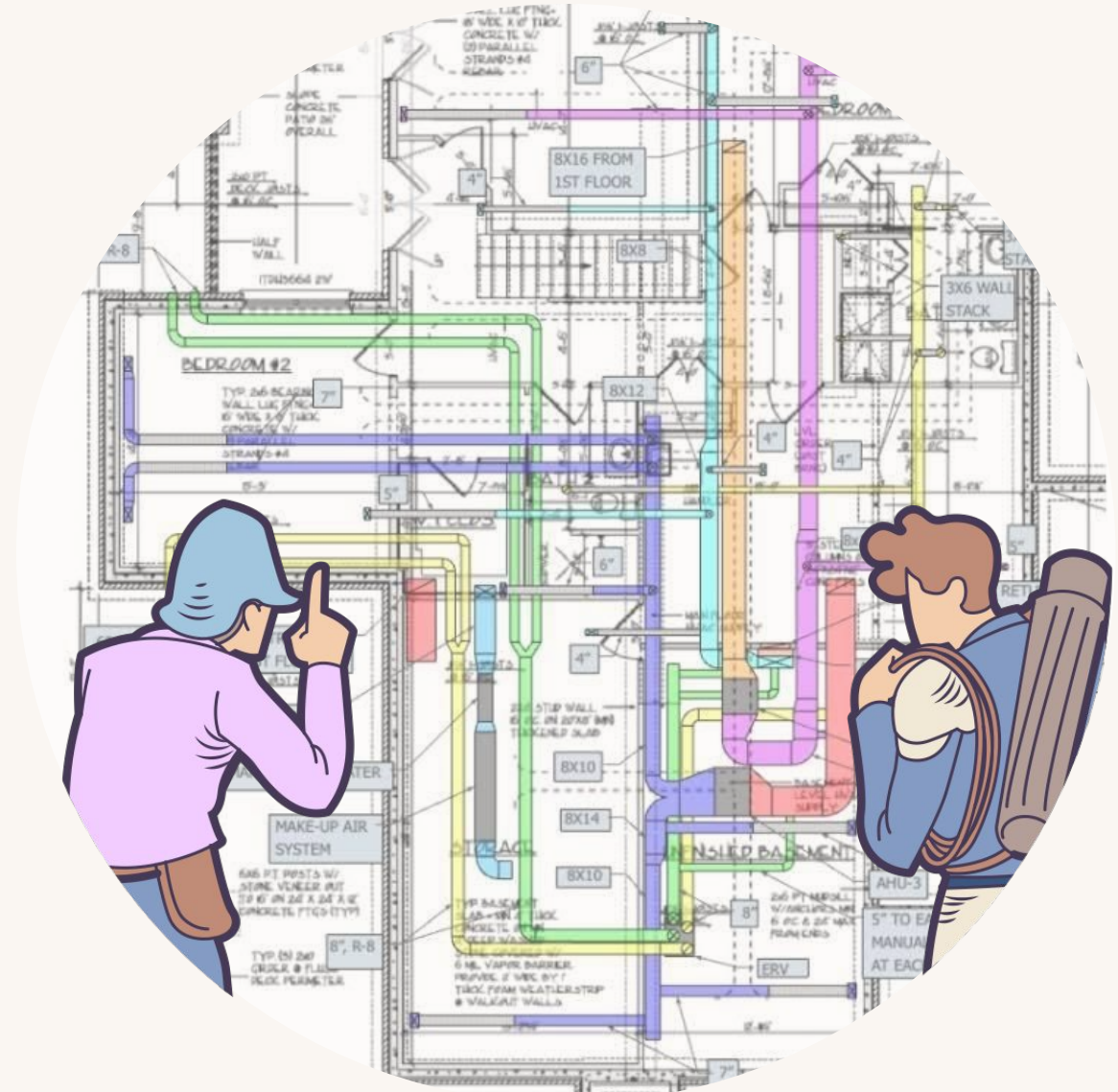



# The Mechanical Room of Requirements



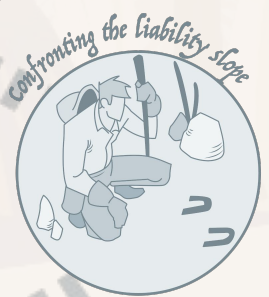

Legendary tradespeople forge the path



Chasing HVAC  
Unicorns

The Hunt for Mythical Systems,  
Fantastical Designs  
& Legendary Tradespeople



# THE INCREDIBLE SHRINKING TRADESMAN!!

They can squeeze  
through any space  
without breaking a sweat



# LEGENDARY TRADESPEOPLE

Always Responsible...  
For the Closet... And the  
Dog..





# Legendary Tradespeople

THEY CAN FLY (OR AT  
LEAST HOVER)

Supply ducts 20' high over a staircase  
(or water bed)? No problem

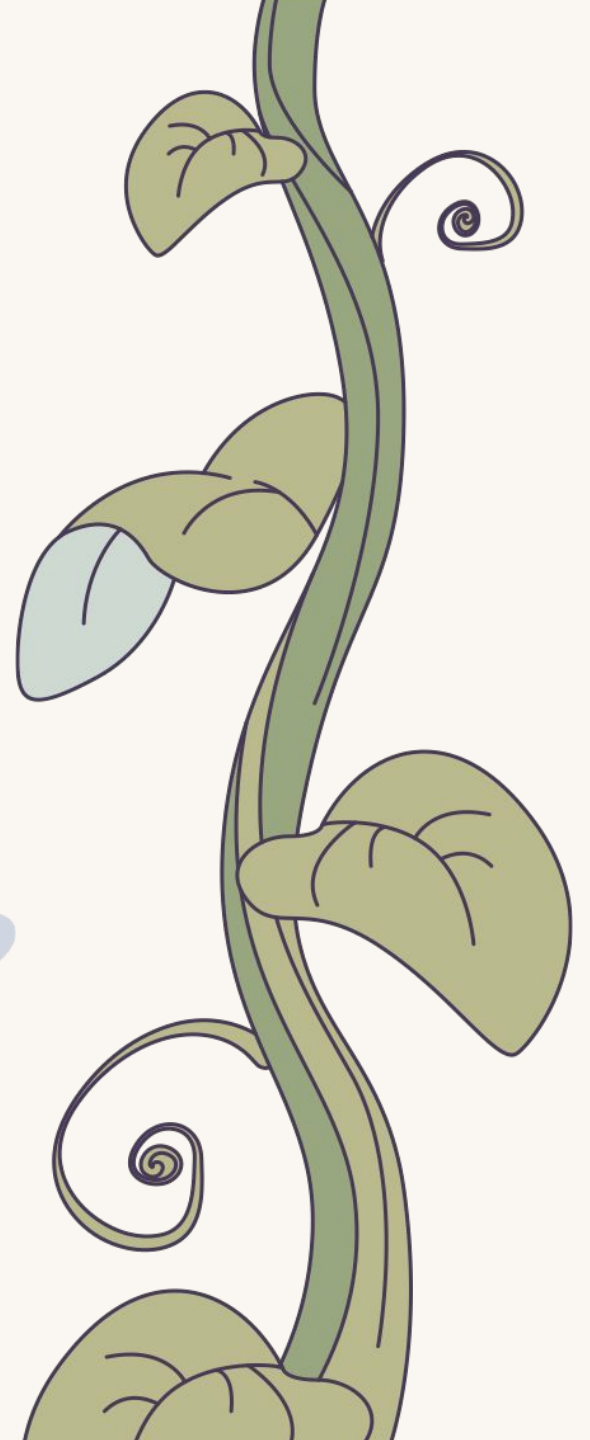

# Legendary Tradespeople - X-Ray Vision

No access to indoor units? No problem, they can see through fine wood paneling.





# Legendary Tradespeople- Have X-ray & can fix your system with their minds



Michelangelo, Ceiling of the Sistine Chapel, 1508-12, fresco (Vatican City, Rome; photo: public domain)



# Transition Comedy/Tragedy



# LEGENDARY TRADESPEOPLE - WHO WANTS TO BE ONE?

## TRADE SCHOOL STIGMA & STEREOTYPES

Nearly 3 out of 4 polled (**73%**) said traditional college gives you a **better future** than trade school

**25%** felt students who attended trade schools were **not as smart** as those who went to traditional college and believe people attending trade schools were **not as motivated** as four-year college grads.







**55%** of respondents believe people with office jobs **earn more respect** than those who work with their hands







National Poll 500 men and women 18-24 conducted by Metal Supermarkets 2021.







WHO NEEDS THEM?... **EVERYONE**



# EPILOGUE - WHAT MESSAGE DOES THIS SEND?

Quick Facts: Construction Managers	
2021 Median Pay 	\$98,890 per year \$47.55 per hour
Typical Entry-Level Education 	Bachelor's degree
Work Experience in a Related Occupation 	None
On-the-job Training 	Moderate-term on-the-job training
Number of Jobs, 2020 	448,000
Job Outlook, 2020-30 	11% (Faster than average)
Employment Change, 2020-30 	51,400

Quick Facts: Heating, Air Conditioning, and Refrigeration Mechanics and Installers	
2021 Median Pay 	\$48,630 per year \$23.38 per hour
Typical Entry-Level Education 	Postsecondary nondegree award
Work Experience in a Related Occupation 	None
On-the-job Training 	Long-term on-the-job training
Number of Jobs, 2020 	380,400
Job Outlook, 2020-30 	5% (Slower than average)
Employment Change, 2020-30 	19,000

Quick Facts: Masonry Workers	
2021 Median Pay 	\$48,040 per year \$23.09 per hour
Typical Entry-Level Education 	<a href="#">See How to Become One</a>
Work Experience in a Related Occupation 	None
On-the-job Training 	<a href="#">See How to Become One</a>
Number of Jobs, 2020 	280,600
Job Outlook, 2020-30 	-2% (Decline)
Employment Change, 2020-30 	-6,000





# THE FAIRYTALE OF THE AMERICAN DREAM IS 4-YEAR COLLEGE

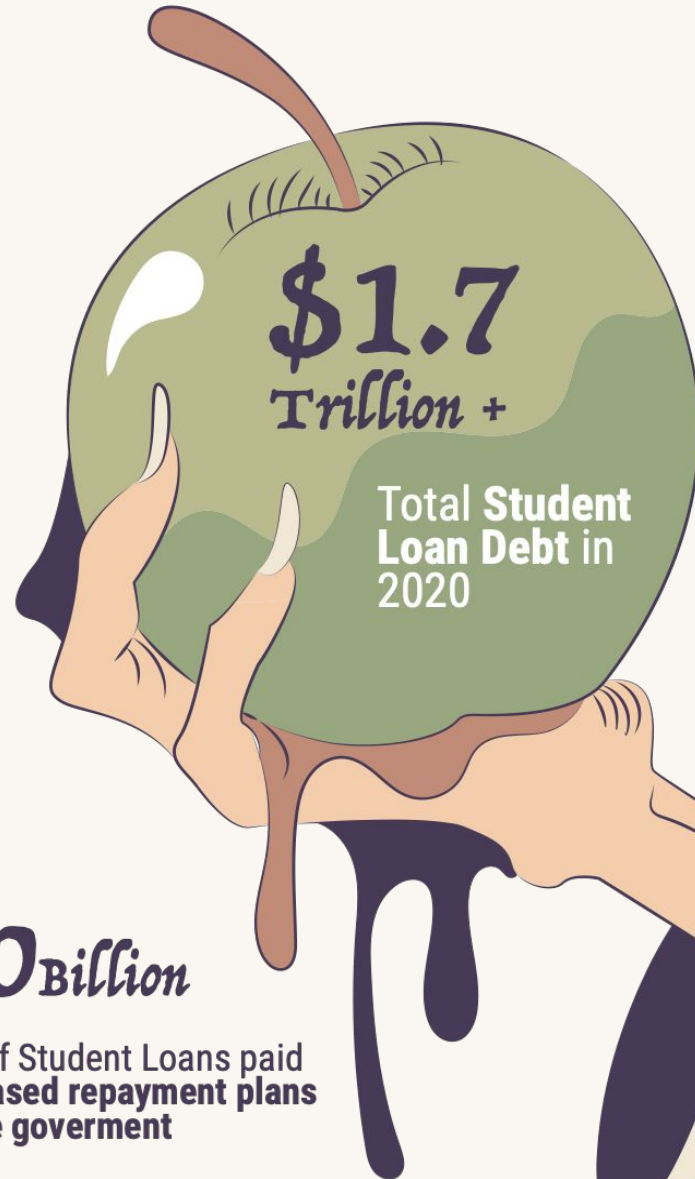

**5.1 Million**  
Number of Direct  
Loan Borrowers

**\$450 Billion**

The amount of Student Loans paid  
via **Income-based repayment plans**  
backed by the government

SOURCE: MAKE IT, MARKETWATCH/2020



# confronting the liability slope

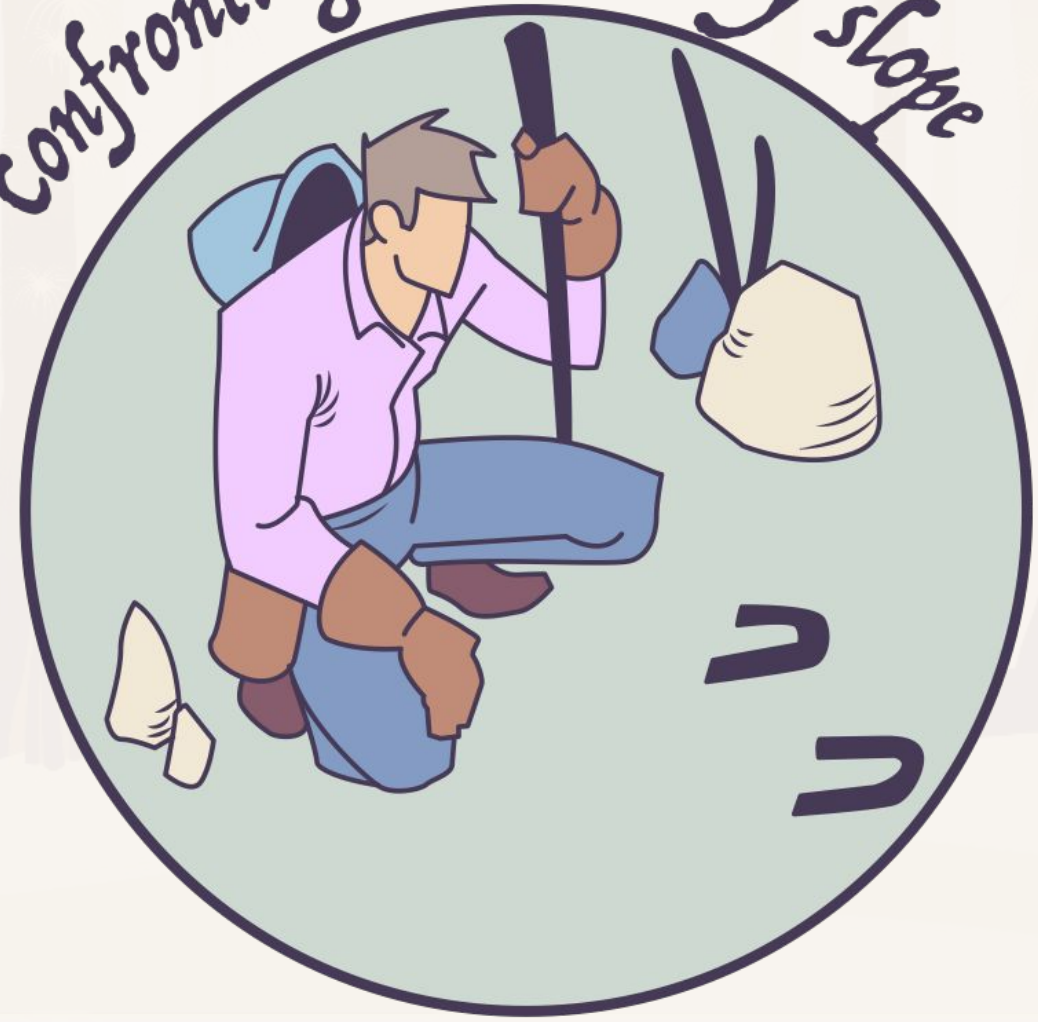

**Chasing HVAC  
Unicorns**

*The Hunt for Mythical Systems,  
Fantastical Designs  
& Legendary Tradespeople*



# CONTRACTORS HOLD THE BAG FOR THE RISK



## THE USE OF INDEMNIFICATION IN CONSTRUCTION CONTRACTS

BY MATTHEW DEVRIES ON MAY 3, 2017 - POSTED IN LEGAL TRENDS

**Contractor agrees to hold harmless and indemnify** the Owner, the Architect, The Lender and each of their agents and representatives for any losses, claims or other damages involving personal injury or property damage, other than to the Work itself, **caused directly or indirectly by Contractor's or its Subcontractor's acts or omissions.**



## EPILOGUE- WHY DON'T LEGENDARY TRADESPEOPLE BUILD FANTASTICAL SYSTEMS?

- Lack of Manufacturer Support
- Liability
- Poor Margins
- No Interest in Rigmarole
- Constant “favors” and “brain picking”



IN SUMMARY – THEIR NEEDS AND INPUT ARE OFTEN IGNORED

“We need coordination drawings for space coordination and sequencing.”

-Peter Marciano

“Once the mechanism is in place for engineers and architects to be held accountable for their screw ups, they’ll be more inclined to play as part of a team. In the meantime, when they oversize equipment and produce crappy duct designs the one that has to deal with the consequences is the installing contractors so why should they care.”

-Genry Garcia

“We need to have more conversation early in the design process. Sitting down with the homeowners to find out how they are going to use a space and what their comfort expectations are, is one of the most important things you can do. And having us be part of the conversation is best.

It costs a lot more money to fix bad designs later than it does to take the time upfront.”

– Nacho Moreno

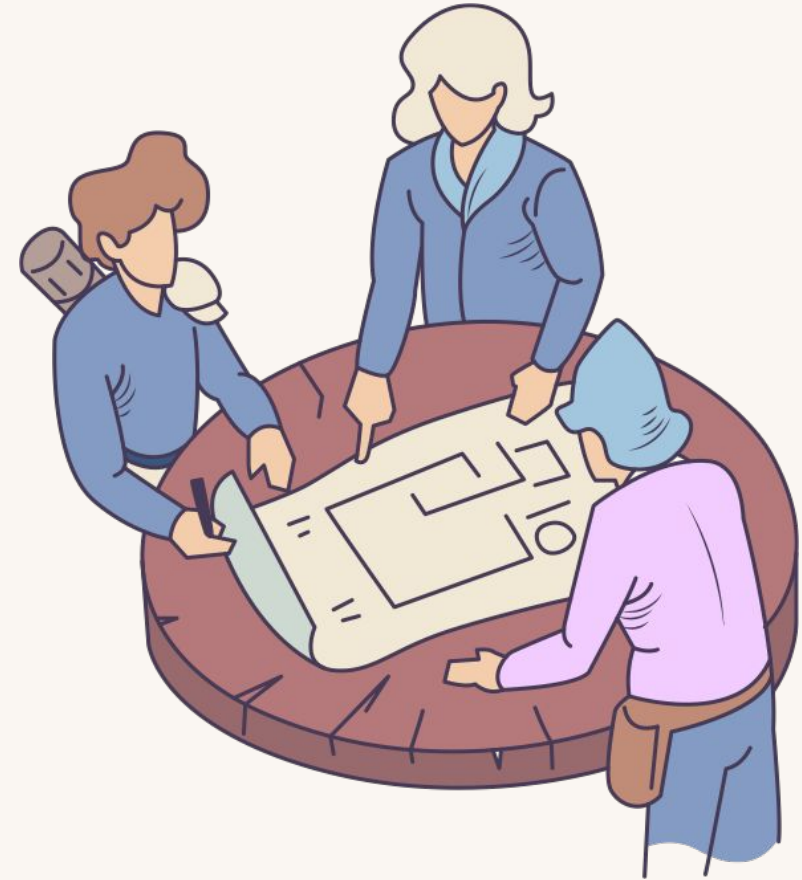

*Understanding mythical systems*



*Mapping location & access*



*Legendary tradespeople forge the path*



*Confronting the liability slope*

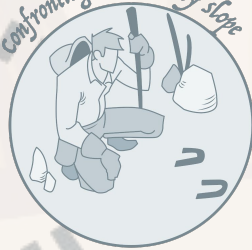

*Communicating respectfully*



# Communicating respectfully



## Chasing HVAC Unicorns

*The Hunt for Mythical Systems,  
Fantastical Designs  
& Legendary Tradespeople*





# How Can We Communicate Effectively?

- **“Teaching”** vs. **“Critical”** voice
- **Authenticity**  
(leaving the ego behind)
- **Being open to learning**
- **Respect is the ultimate goal**



# Our struggle is not against flesh & blood...

“Architects, engineers and trades people repeatedly do great things together where and when everyone is adequately qualified and incentivized. We see this coming together again and again over decades. These are very often for extremely demanding customers who have the budget to make possible.”

RICK SIMS



# Who should be at this table.. write your own story

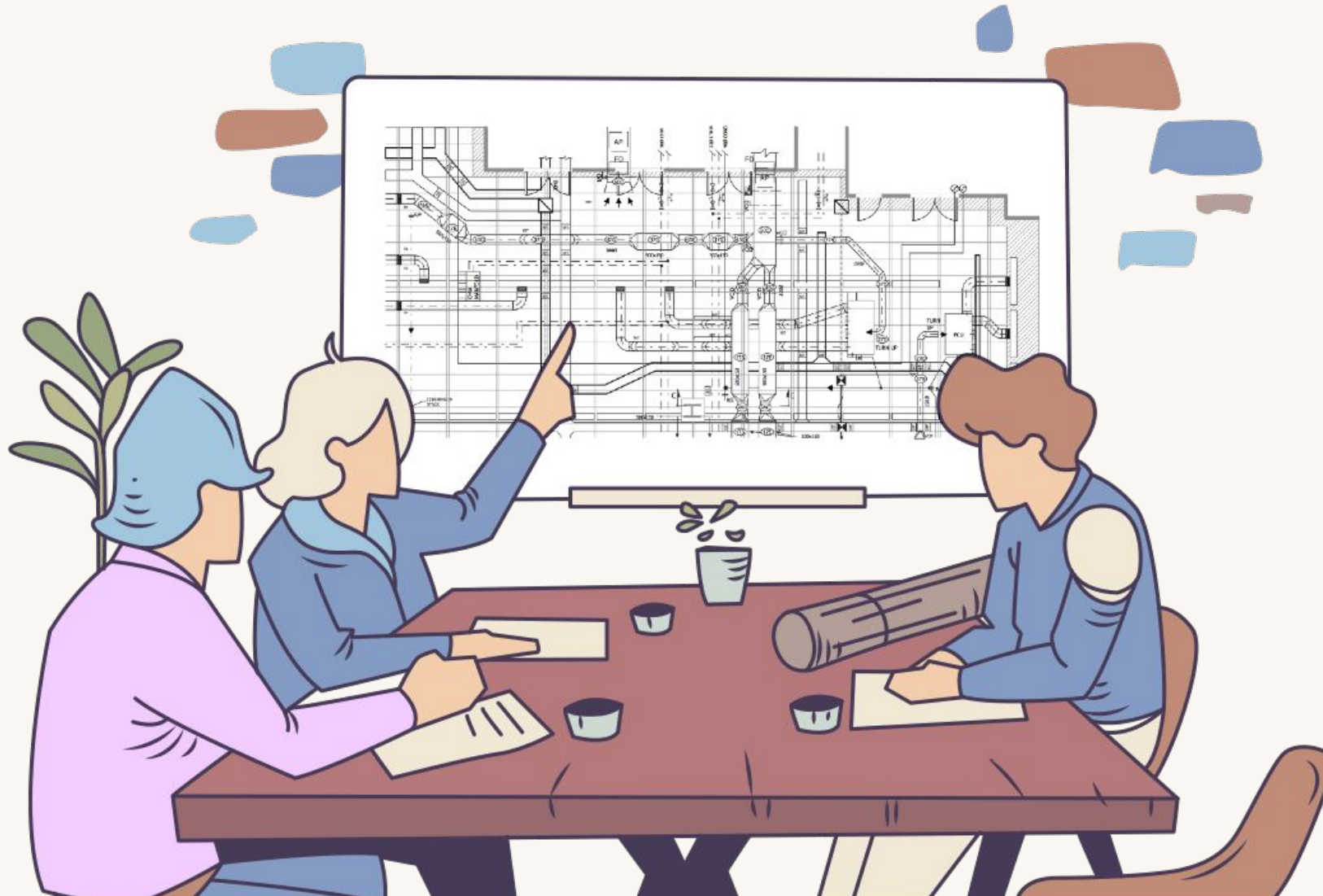



# Big Thanks to...

**Peter Marciano** - Legacy Buildings

**Nacho Moreno** - New Results HVAC

**Neil Comparetto** – Comfort Squad

**Genry Garcia** – CDI HVAC

**Regan Murphy** – Clean Air AC

**Rick Sims** – Johnson’s Air Conditioning

**Michael Housh** – Housh Home Energy

**Kristof Irwin** - Positive Energy

**Betsy & Joe** - Westford Symposium on Building Science

