

Joseph Lstiburek, Ph.D., P.Eng, ASHRAE Fellow

Continuous Insulation

Best Practices

IAC07A | 1 AIA HSW/LU CE Hour

www.buildingscience.com

- **An American Institute of Architects (AIA) Continuing Education Program**

Approved Promotional Statement:

•Ron Blank & Associate, Inc.. is a Registered Provider with The American Institute of Architects Continuing Education Systems (AIA/CES). Credit(s) earned on completion of this program will be reported to AIA/CES for AIA members. Certificates of Completion for both AIA members and non-AIA members are available upon request.

•This program is registered with AIA/CES for continuing professional education. As such, it does not include content that may be deemed or construed to be an approval or endorsement by the AIA or GreenCE, Inc. of any material of construction or any method or manner of handling, using, distributing, or dealing in any material or product.

•Questions related to specific materials, methods, and services will be addressed at the conclusion of this presentation.



- **An American Institute of Architects (AIA) Continuing Education Program**

- Course Format: This is a live, instructor-led webinar course.
- Course Credit: 1 AIA Health Safety & Welfare (HSW) CE Hour
- Completion Certificate: A copy is sent to you by email upon request. When you fill out the Course Attendance, please indicate if you need one. Also please ensure the information you provide is legible. Send email requests to certificate@infospecinc.com



Design Professionals: Certificates are sent to your email address within 1 week of this presentation from certificate@infospecinc.com

3

Course Description

1. Discuss some foundational principles and knowledge related to building science regarding practical applications and considerations
2. Identify the key aspects to controlling water vapor using continuous insulation to avoid condensation and moisture accumulation
3. Explain the different ways of managing rain water with various water-resistant barrier (WRB) methods, including use of foam sheathing with tape joints and adhered flashing, use of a separate WRB, etc.
4. Explain various tried-and-true techniques and detailing sequences to install and flash windows together with foam sheathing and the various WRB strategies that may be considered good, better, and best practices

4

Learning Objectives

One of the most controversial yet important subjects affecting modern housing construction is insulation and moisture control. This webinar will address relevant building science principles, materials & methods of construction, practical insights and useful resources related to the appropriate integration of foam sheathing (continuous insulation) onto wall assemblies for code compliance and durable performance.

5

What is a Building?

6

A Building is an Environmental Separator

7

2nd Law of Thermodynamics

8

In an isolated system, a process can occur only if it increases the total entropy of the system

Rudolf Clausius

9

Heat Flow Is From Warm To Cold
Moisture Flow Is From Warm To Cold
Moisture Flow Is From More To Less
Air Flow Is From A Higher Pressure to a
Lower Pressure
Gravity Acts Down

10

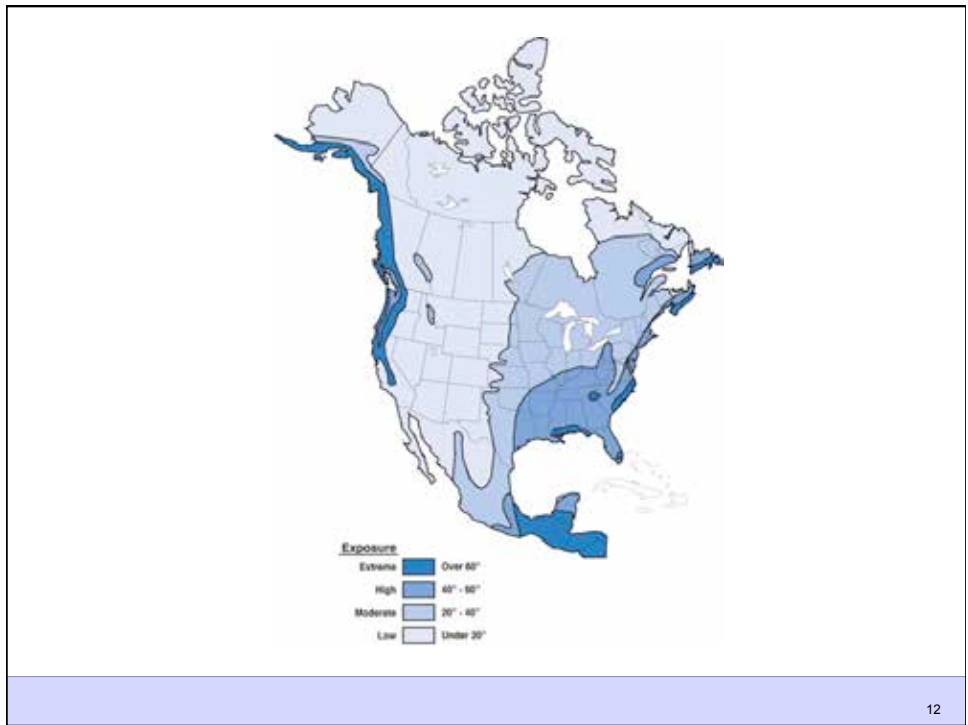
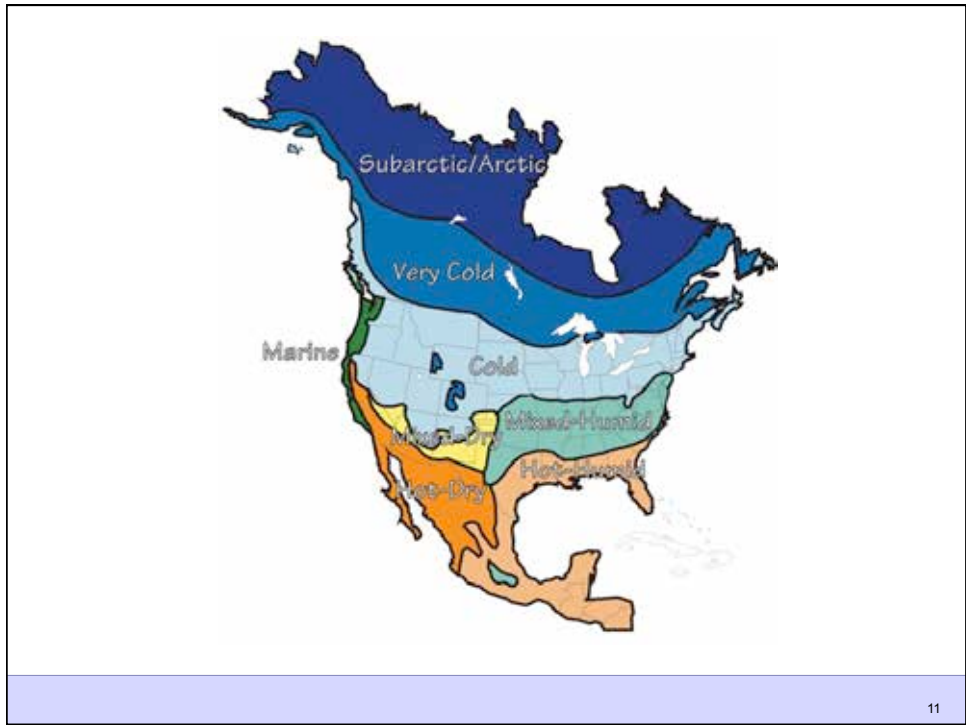

Water Control Layer
Air Control Layer
Vapor Control Layer
Thermal Control Layer

13

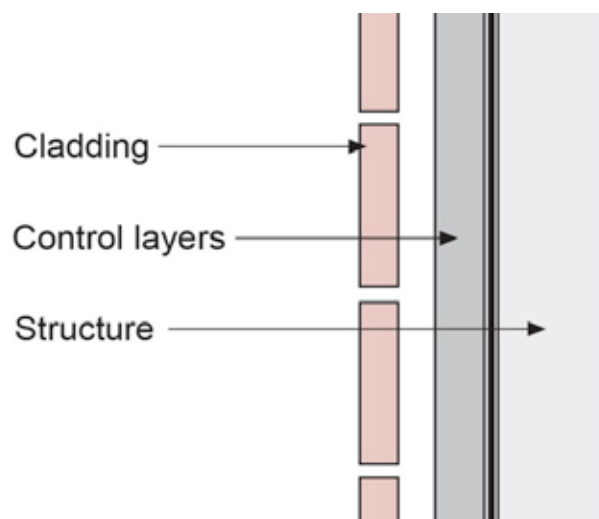

14

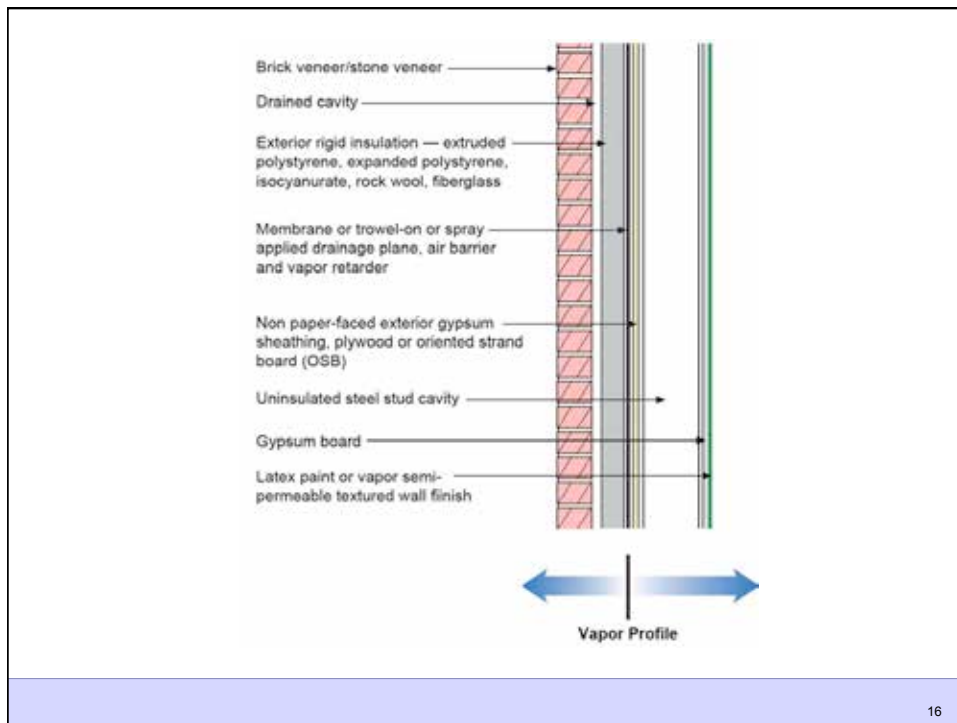
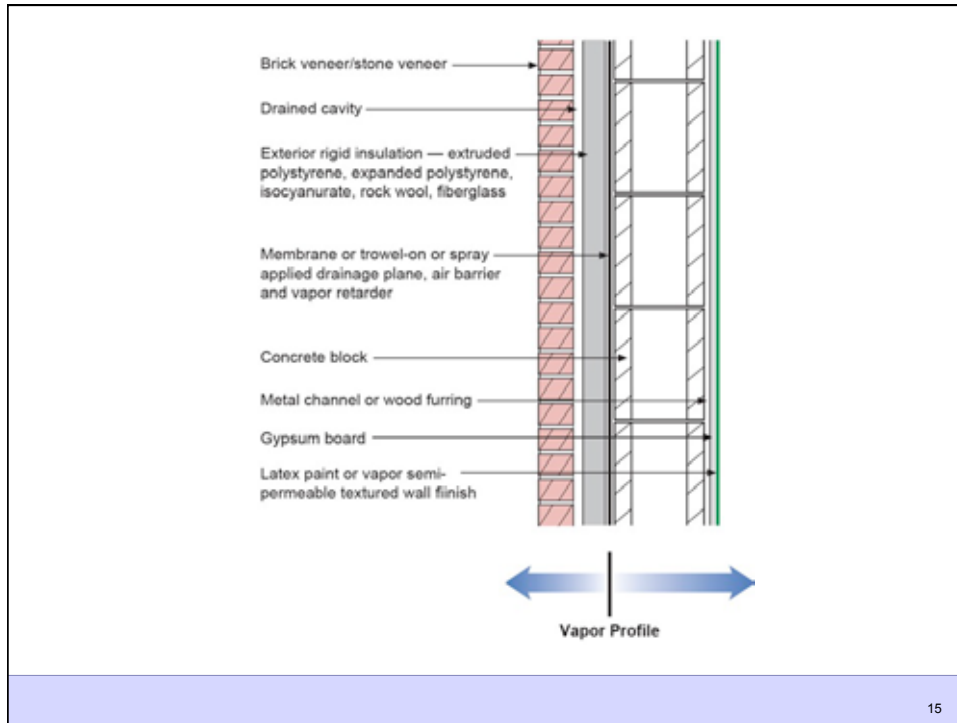

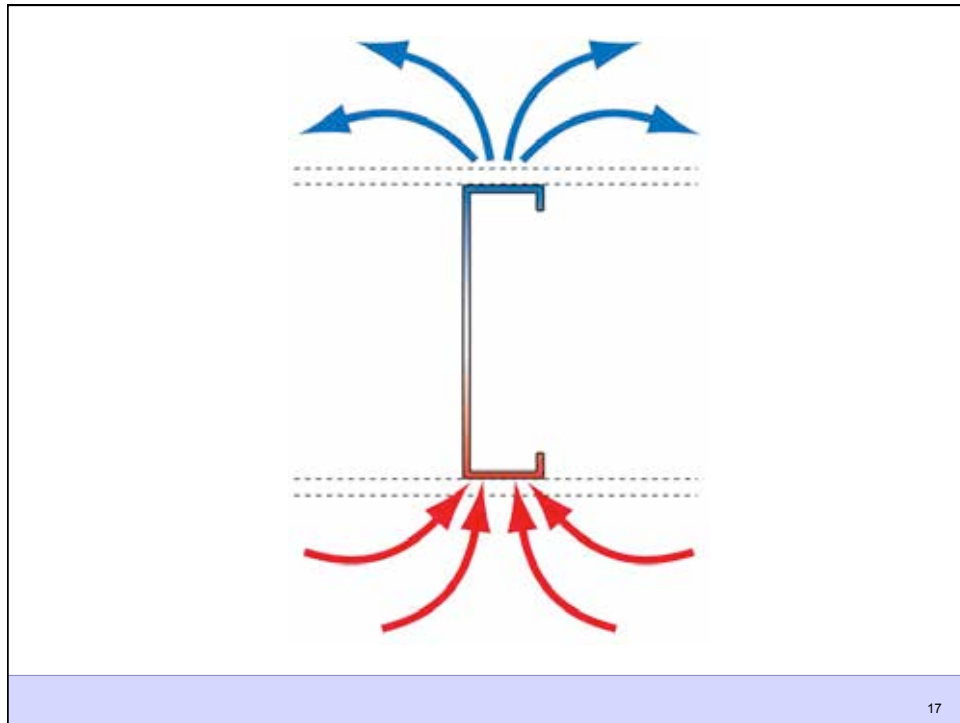

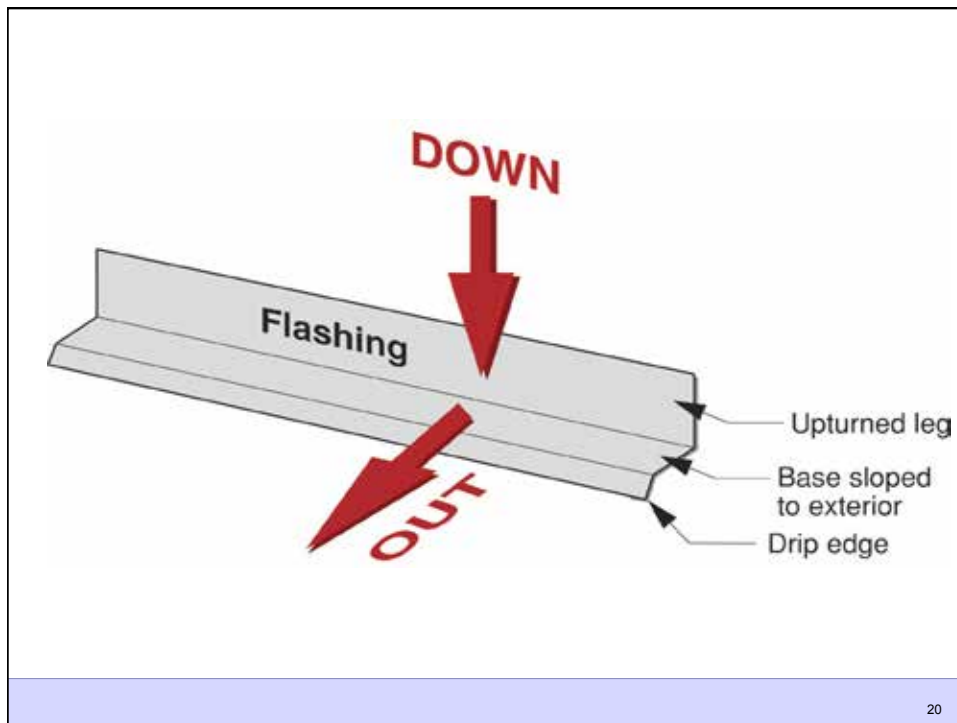
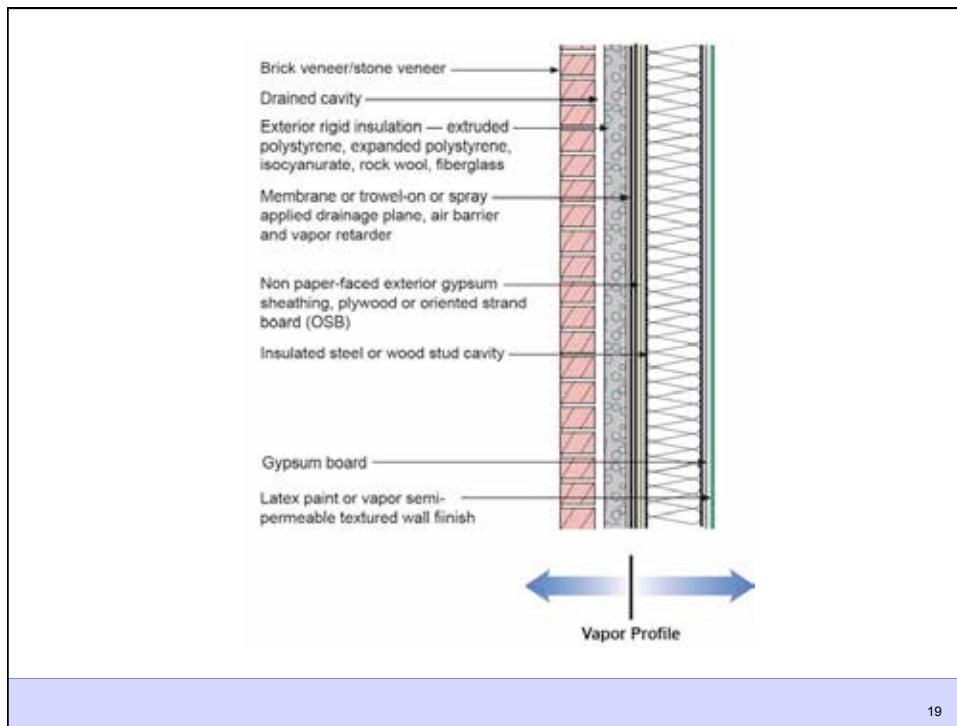

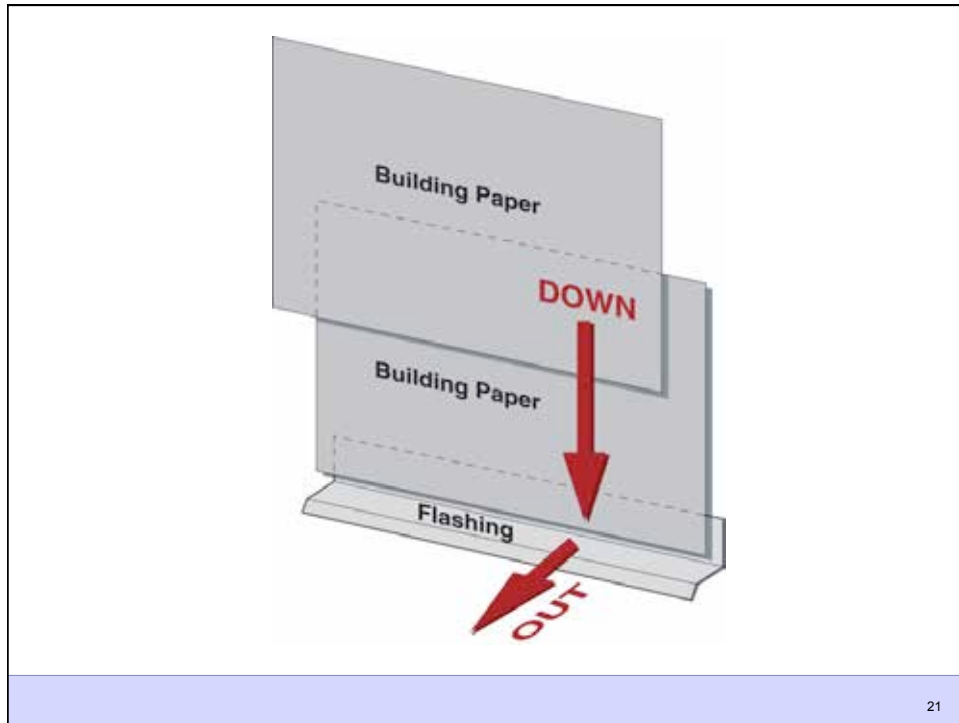













33



34



35

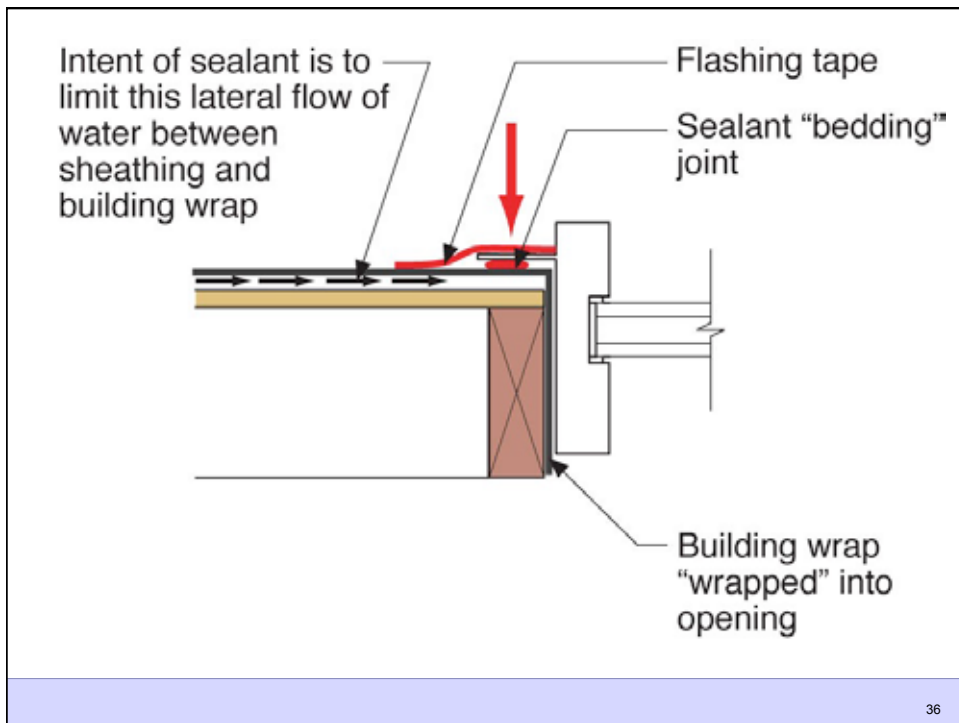

36





39



40

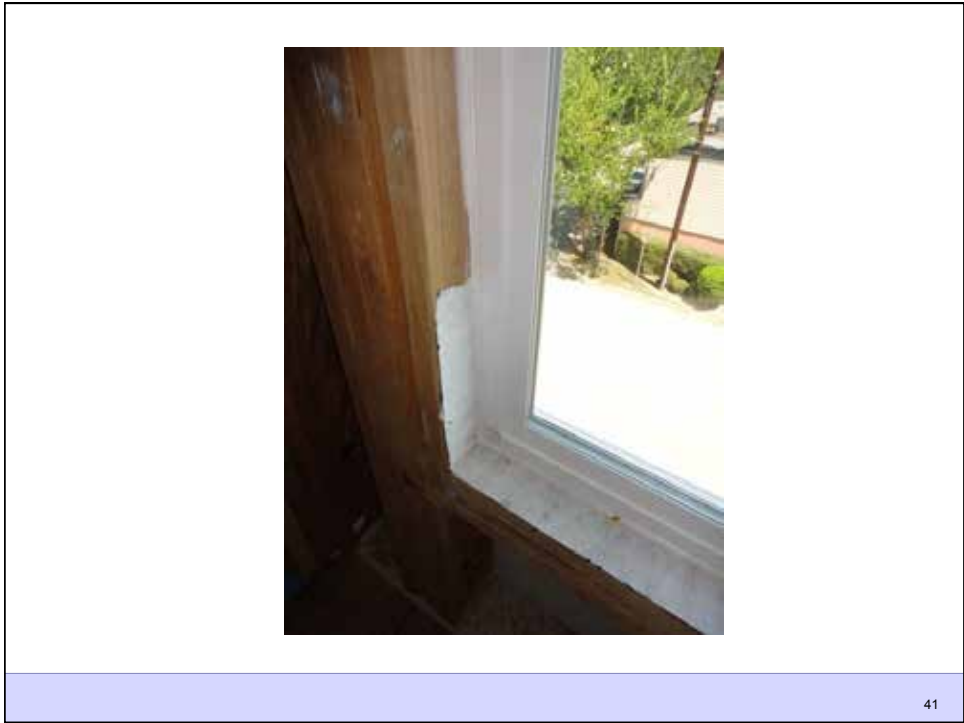





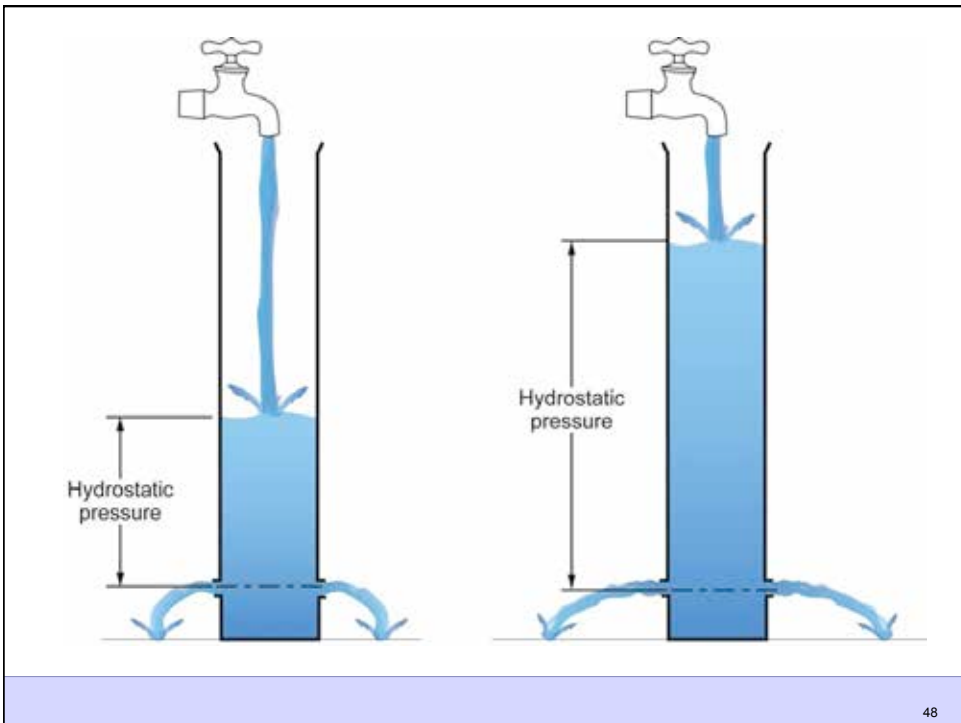
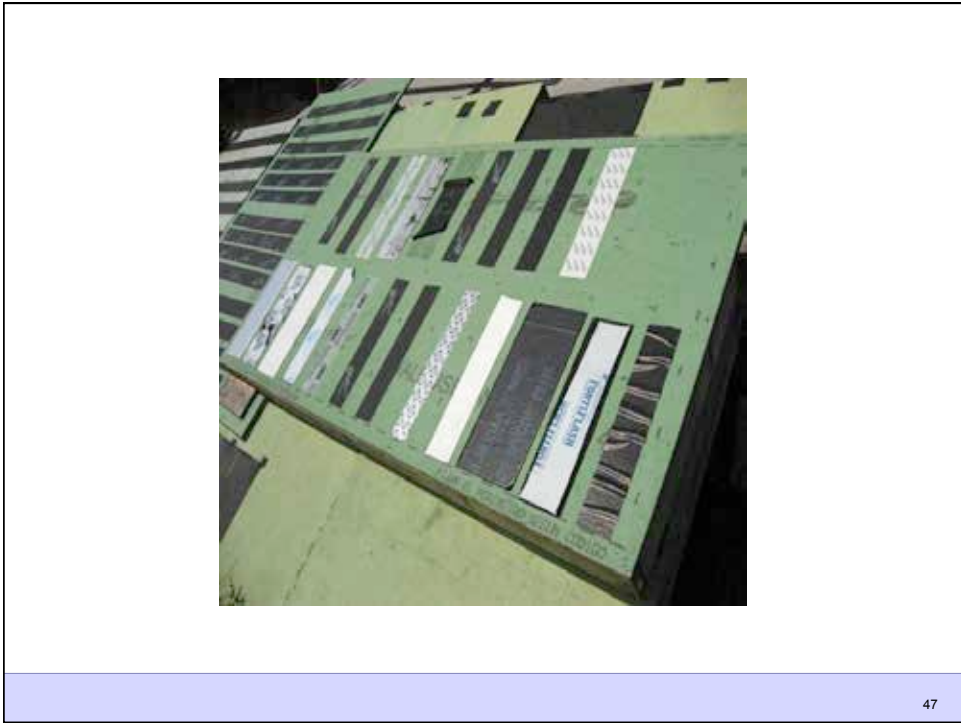

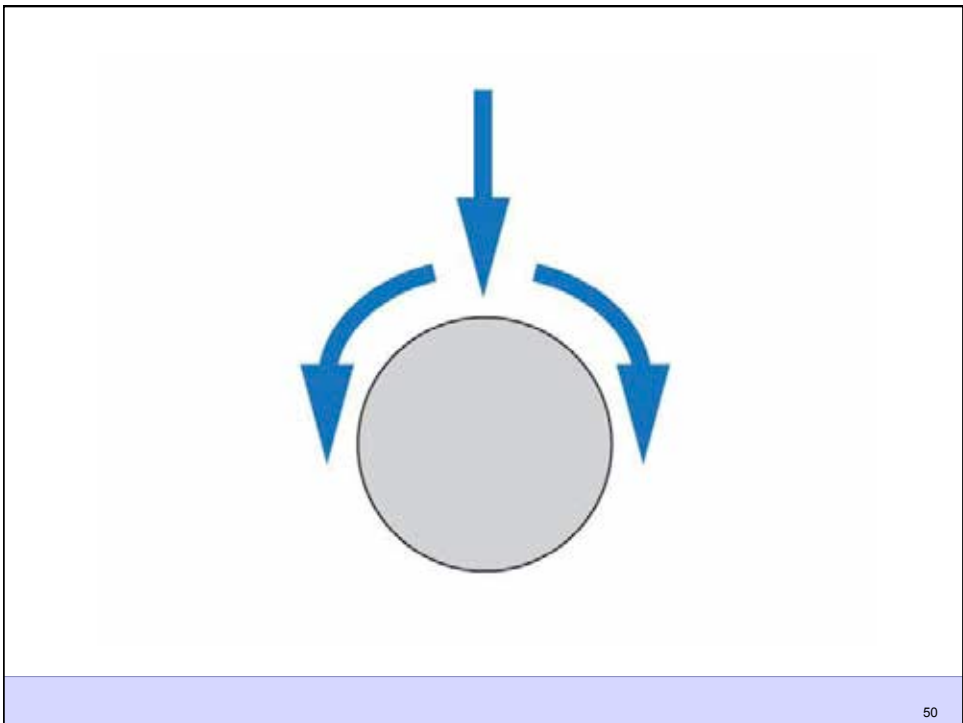

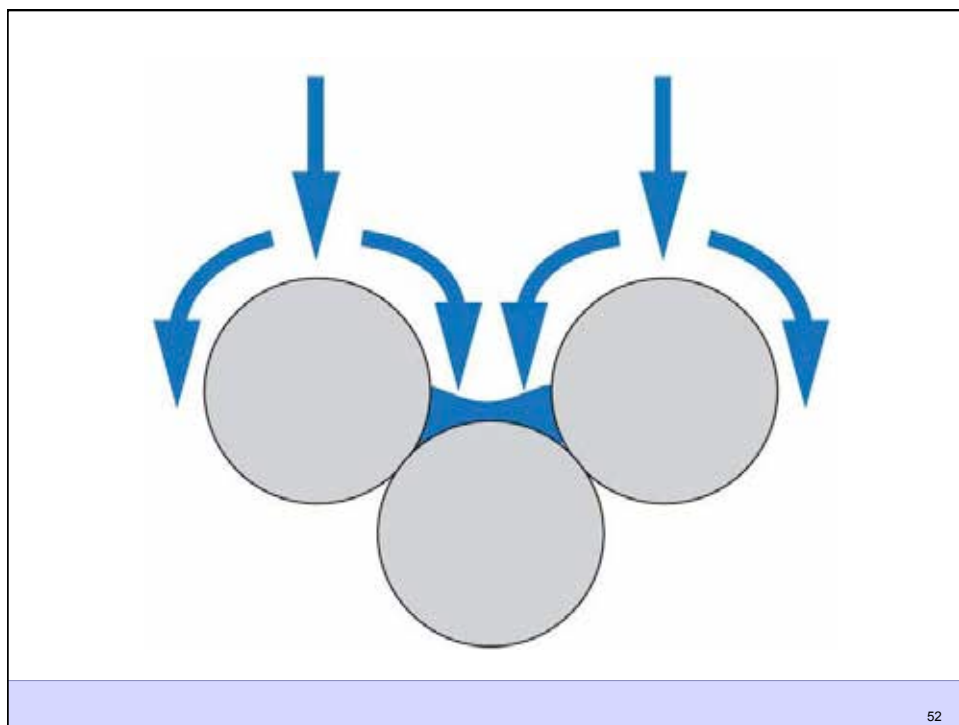
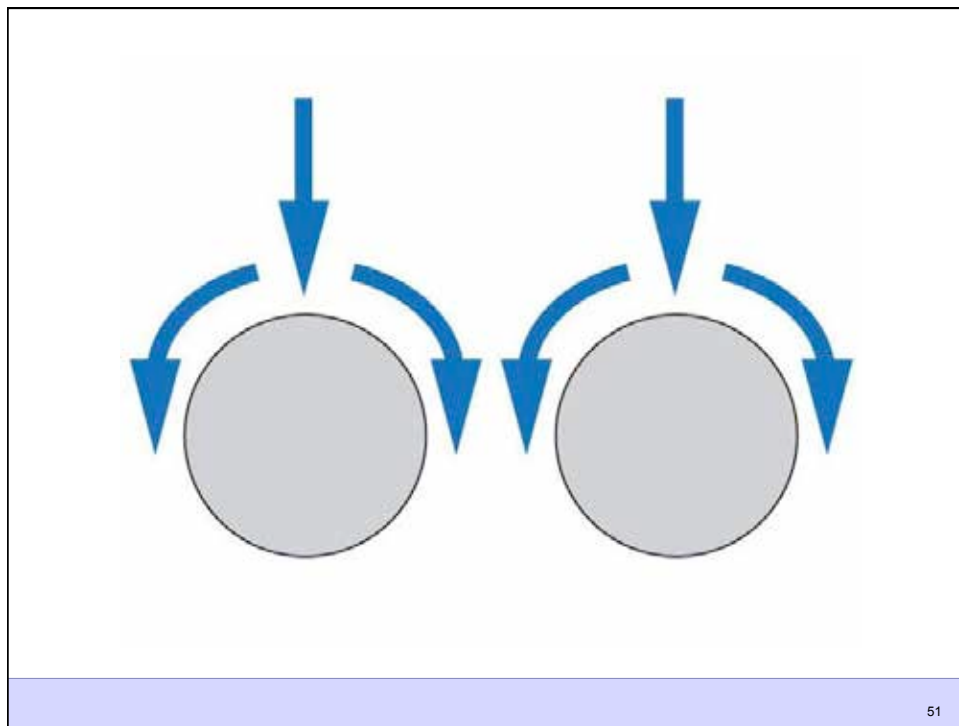



53

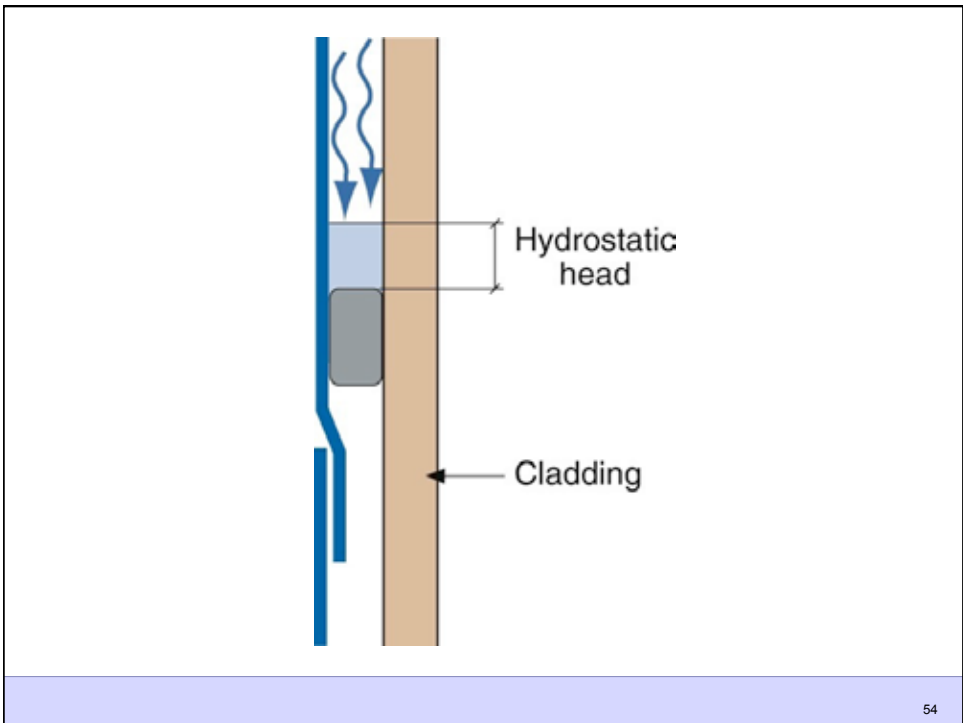

54

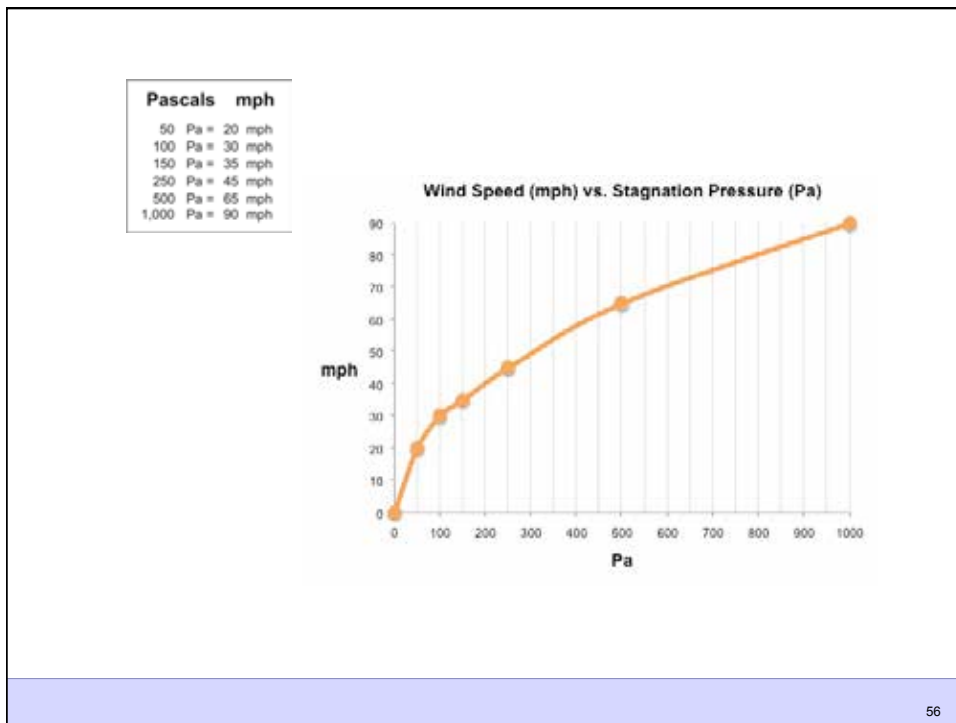
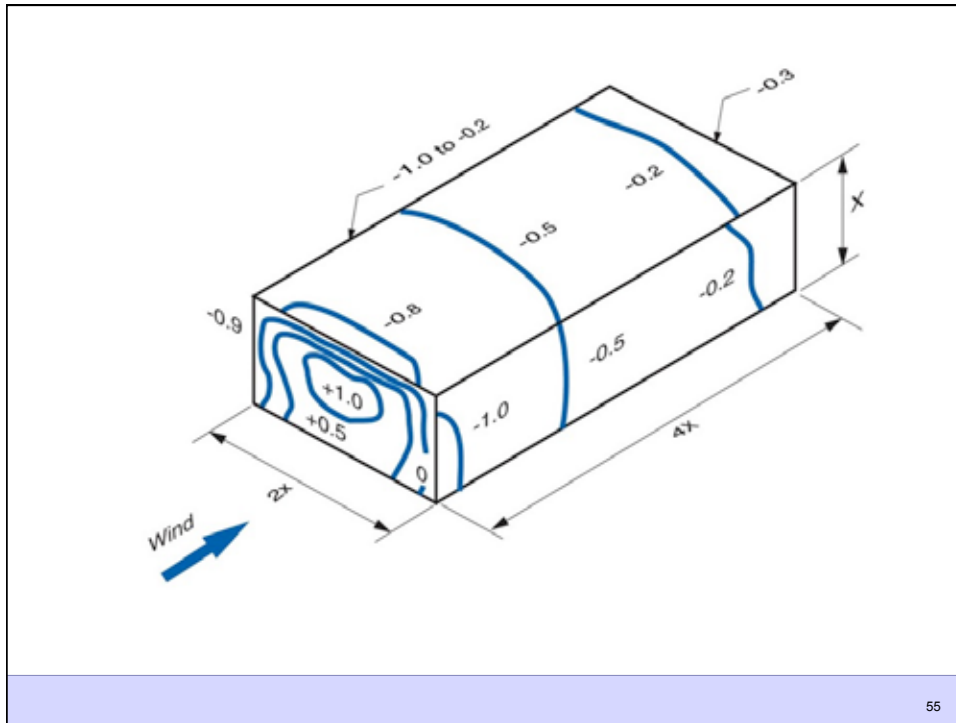



57



58

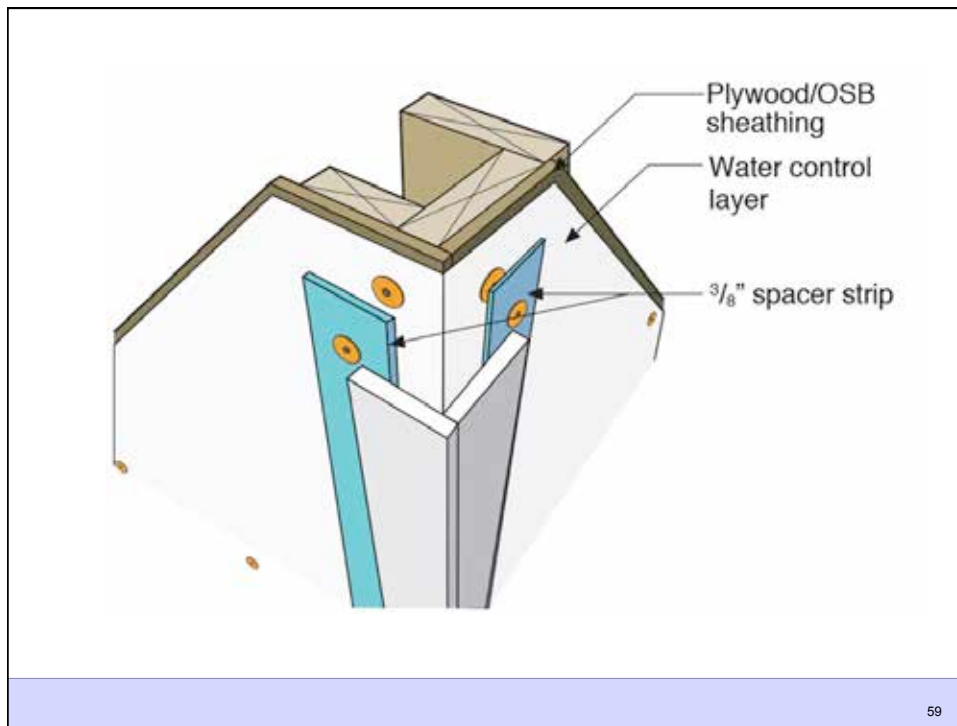



Rain Screen

63

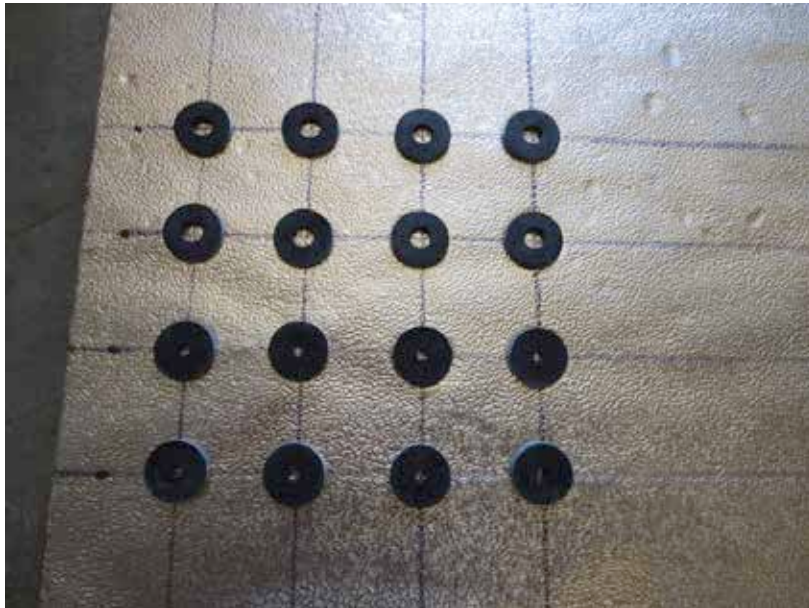

64

Beer Screen?

65

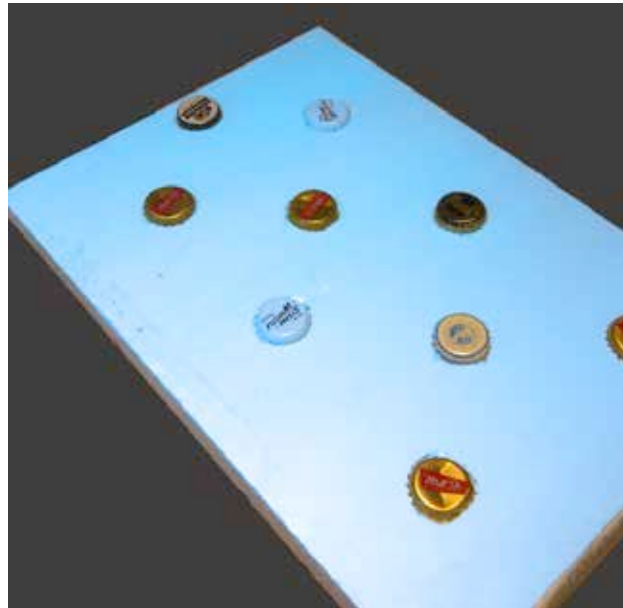

66

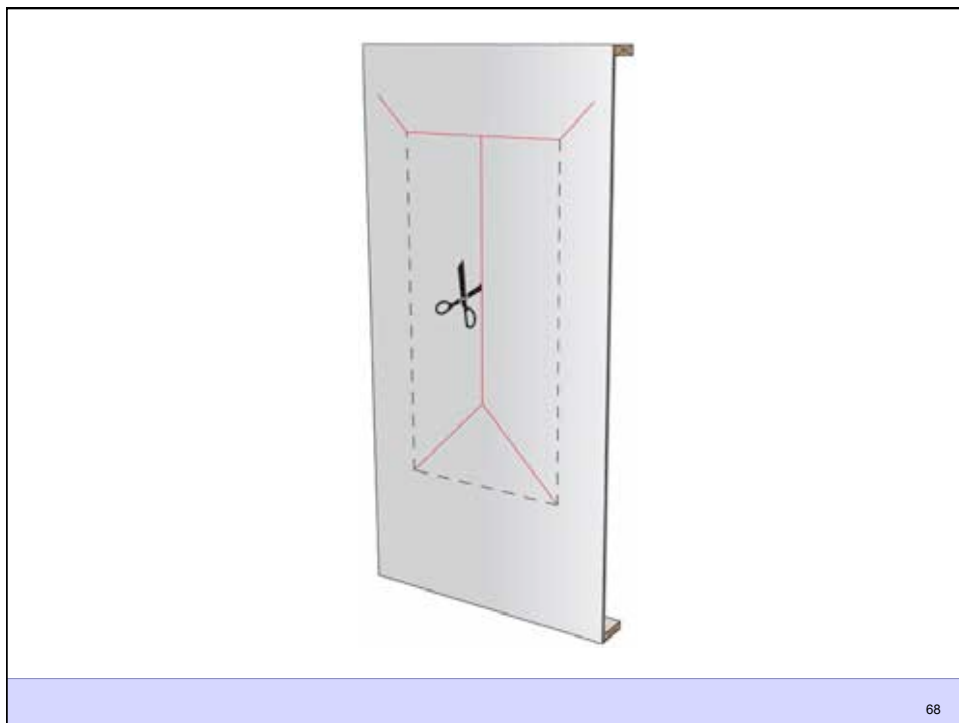
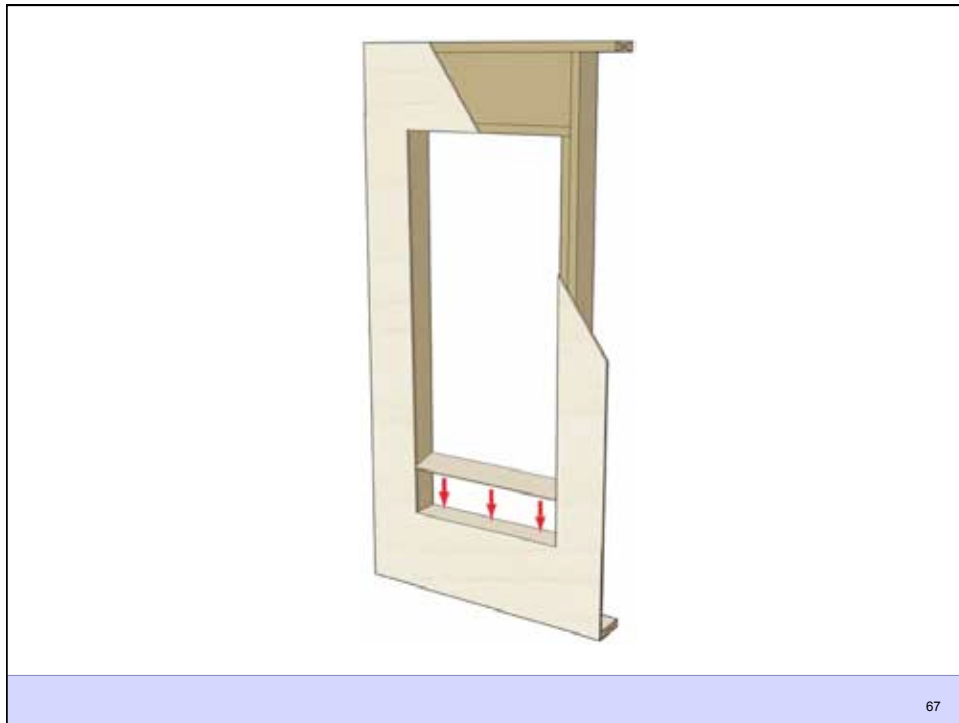

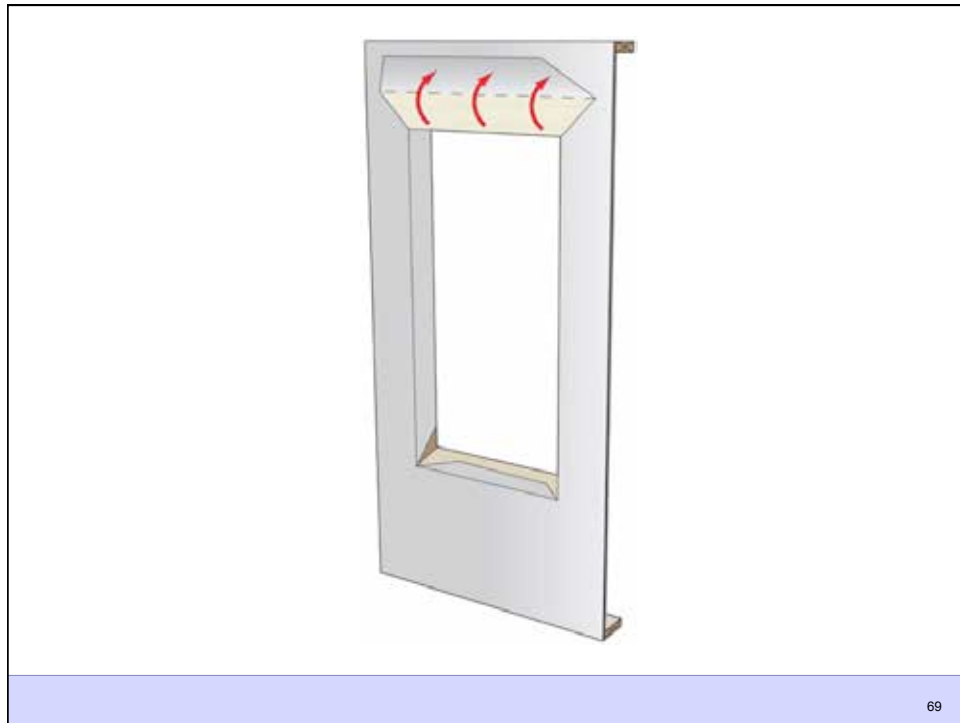







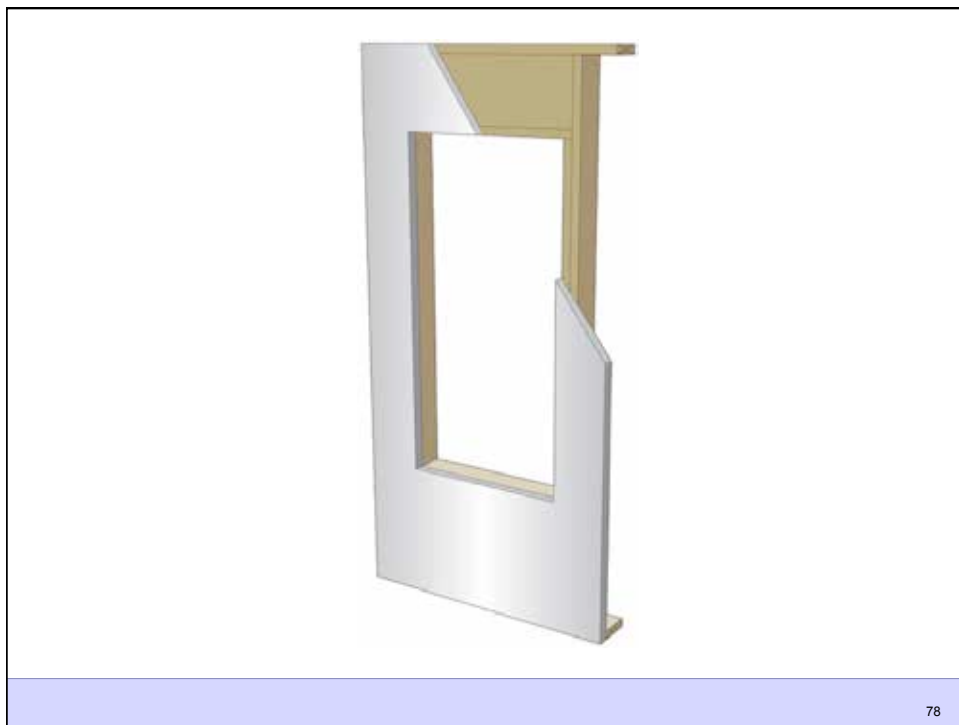
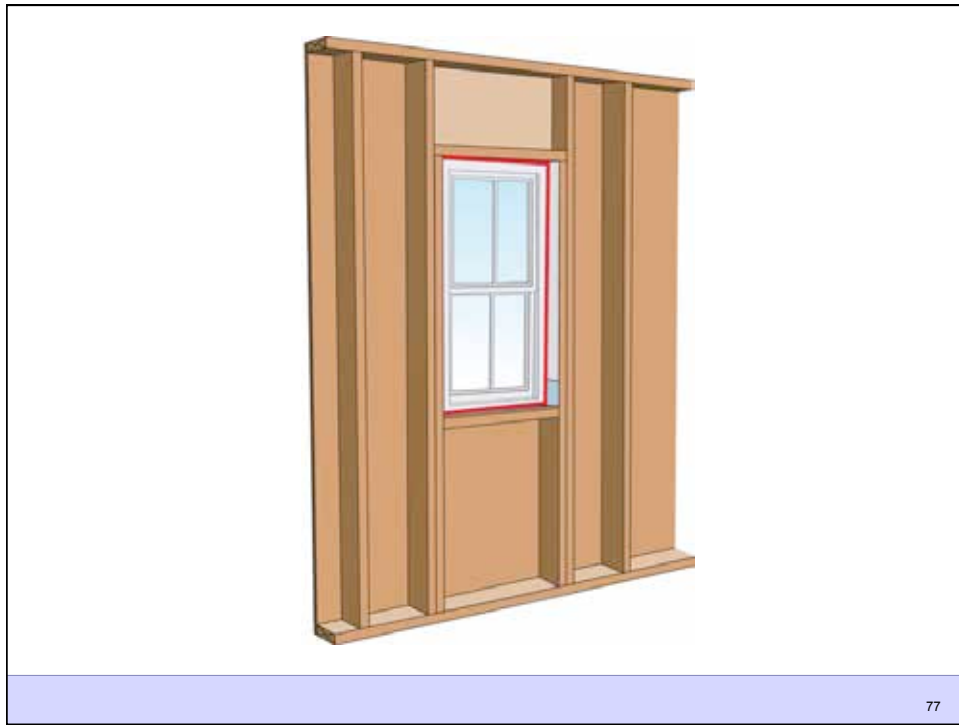

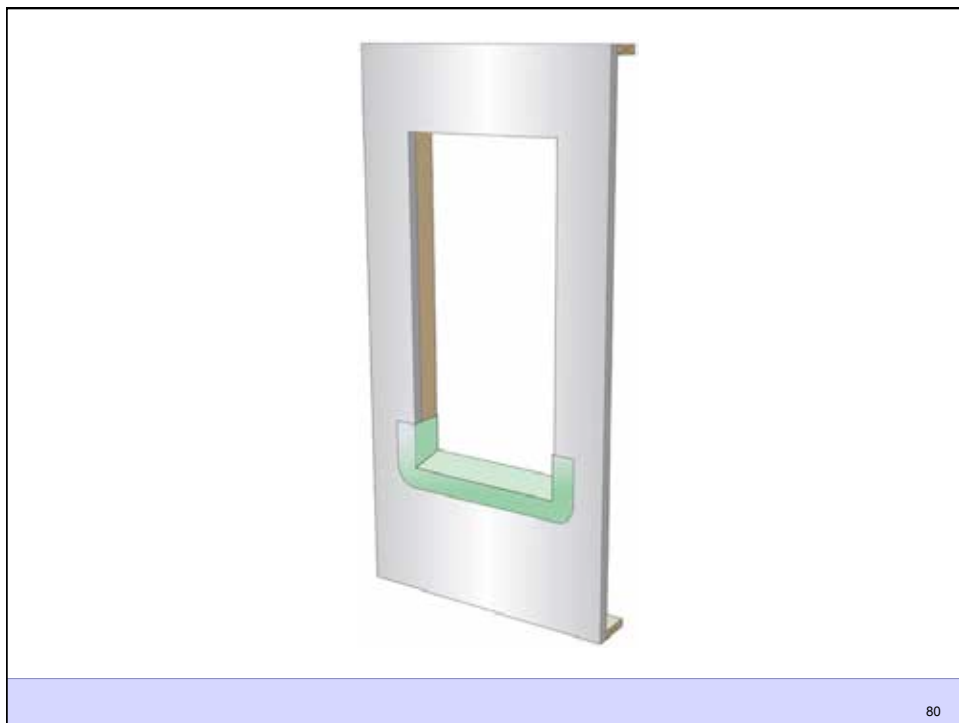
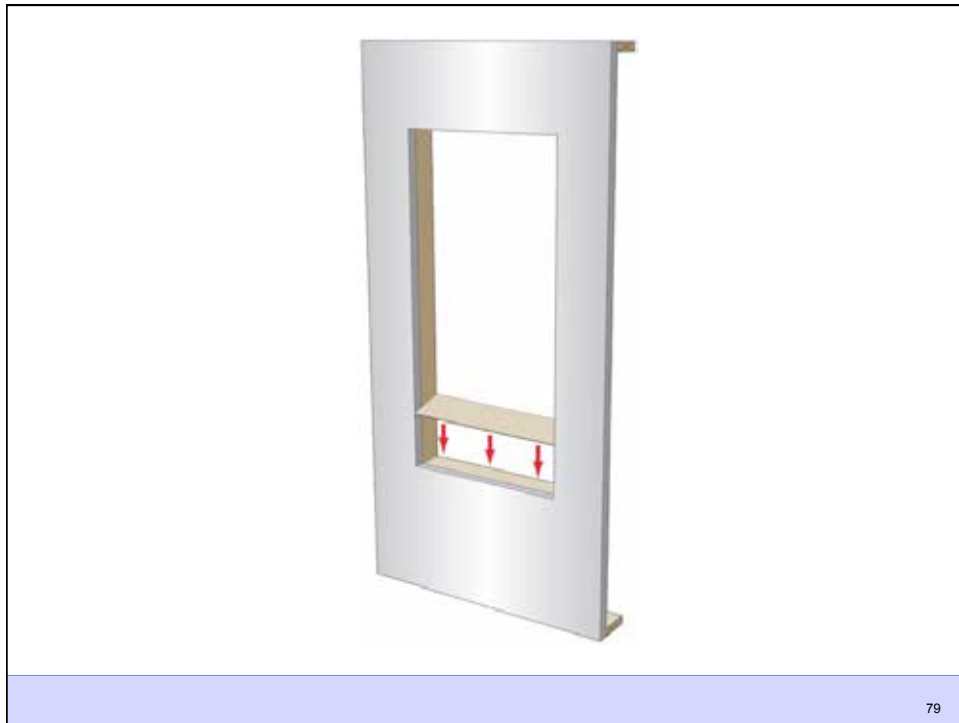

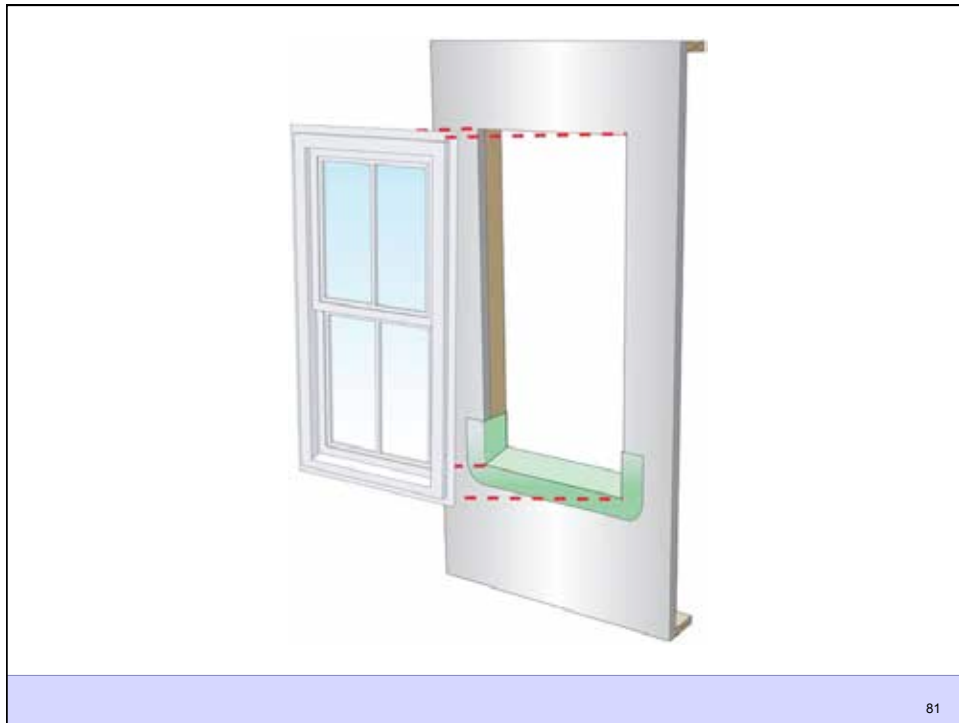

81



82







87

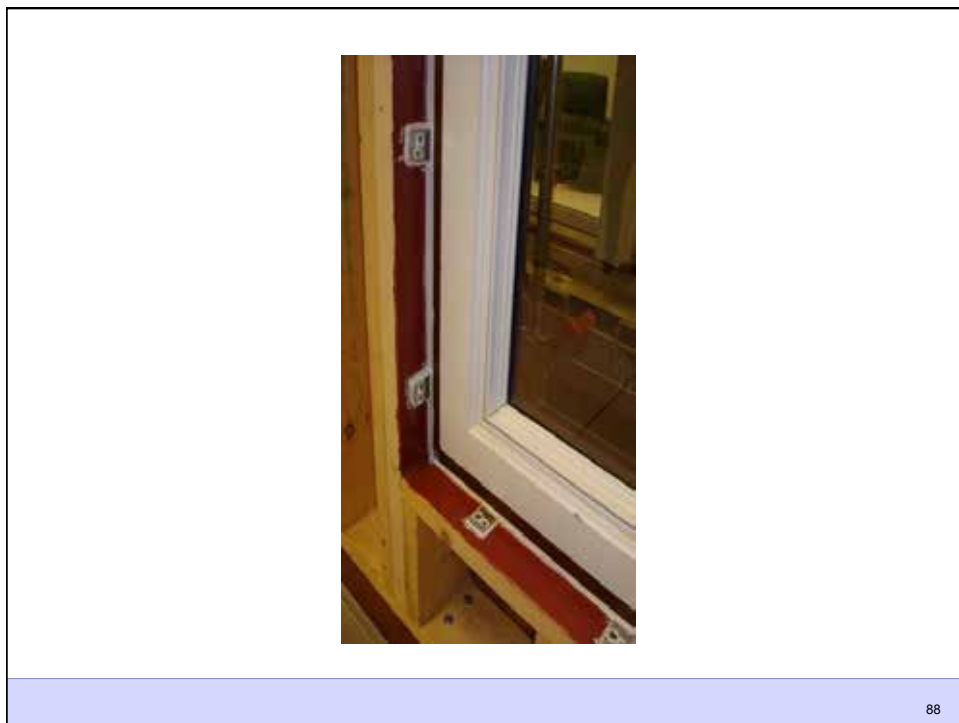

88

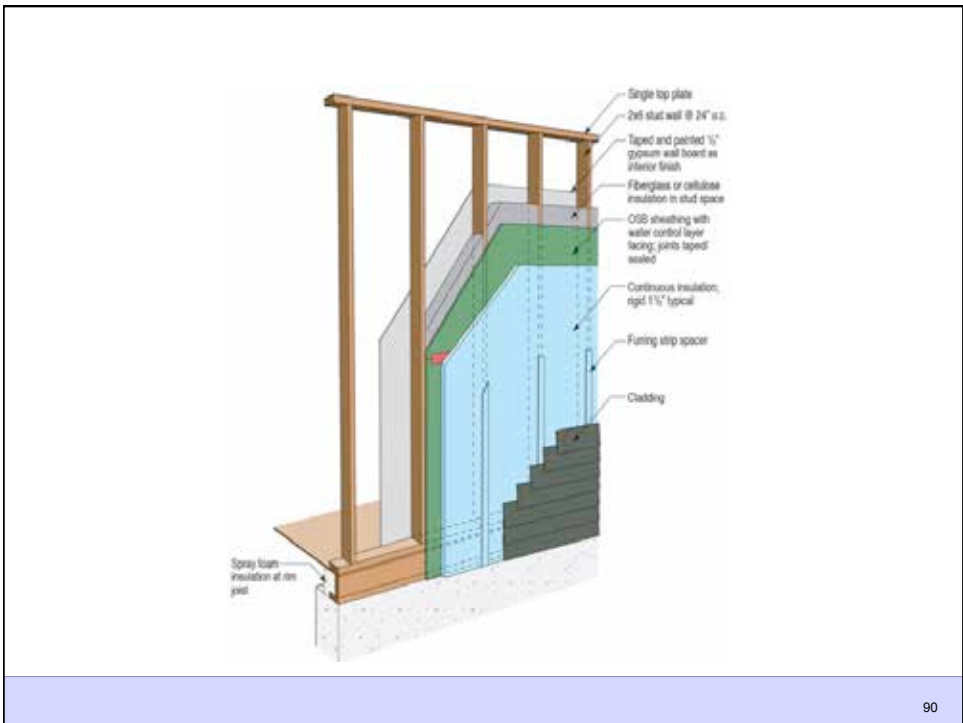

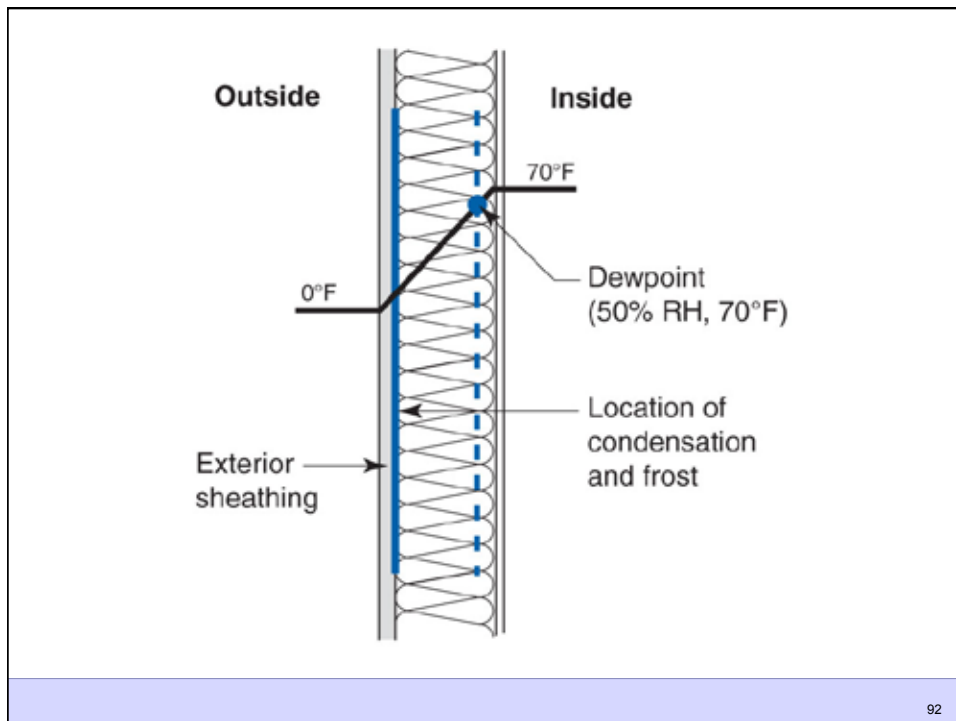
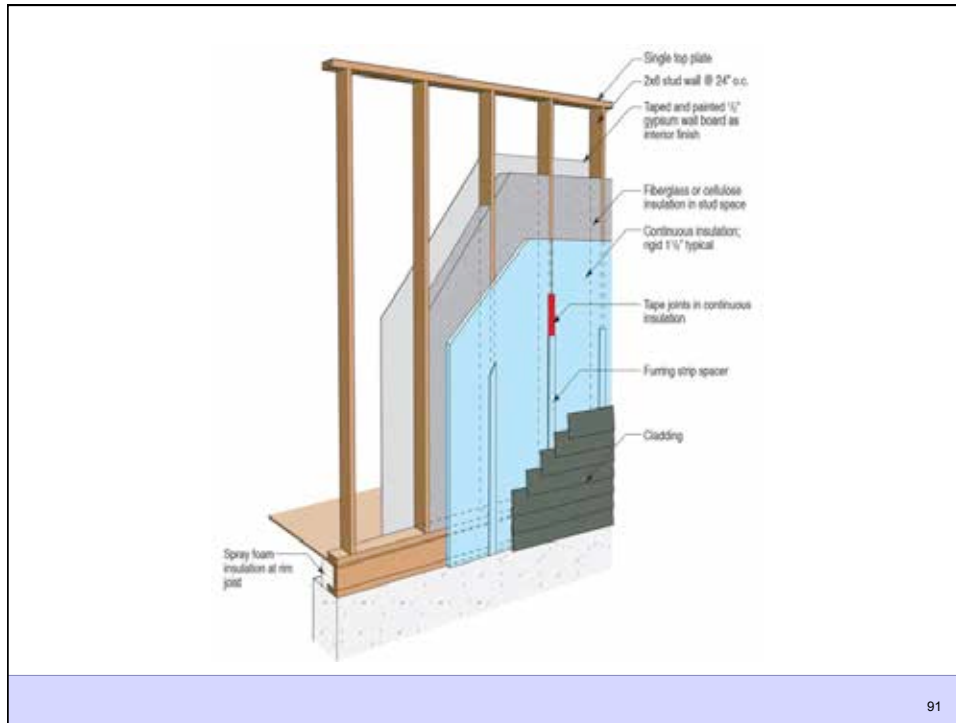

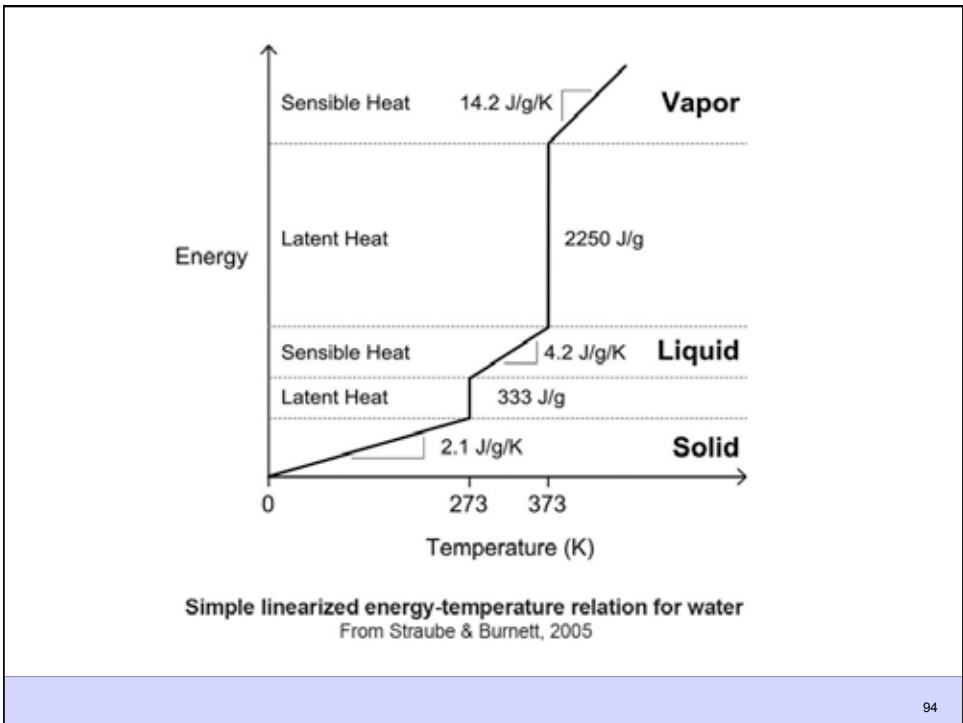

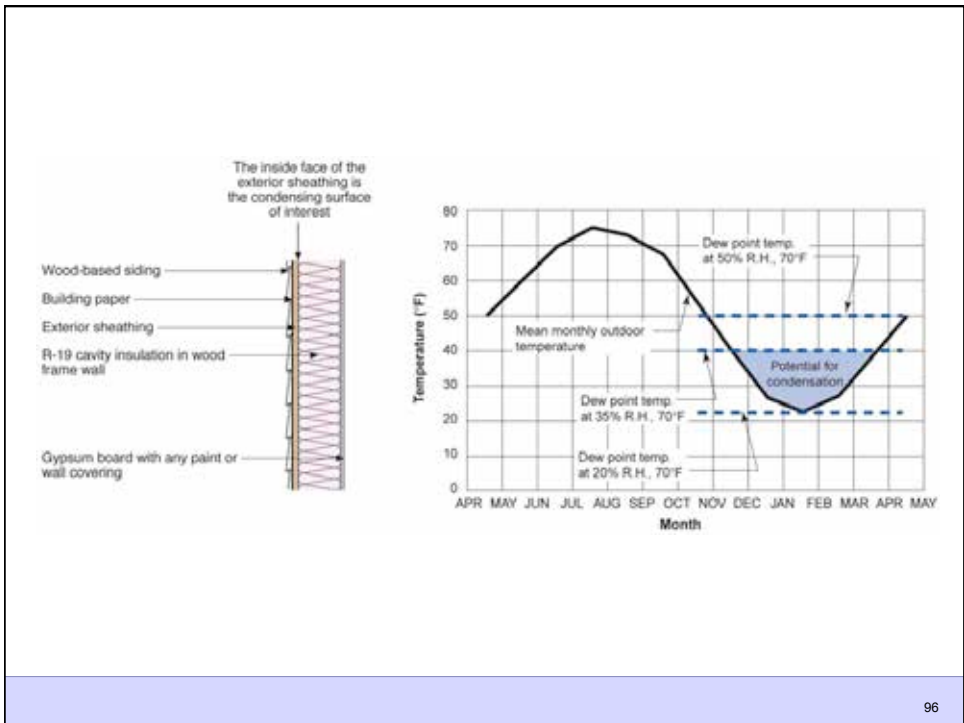
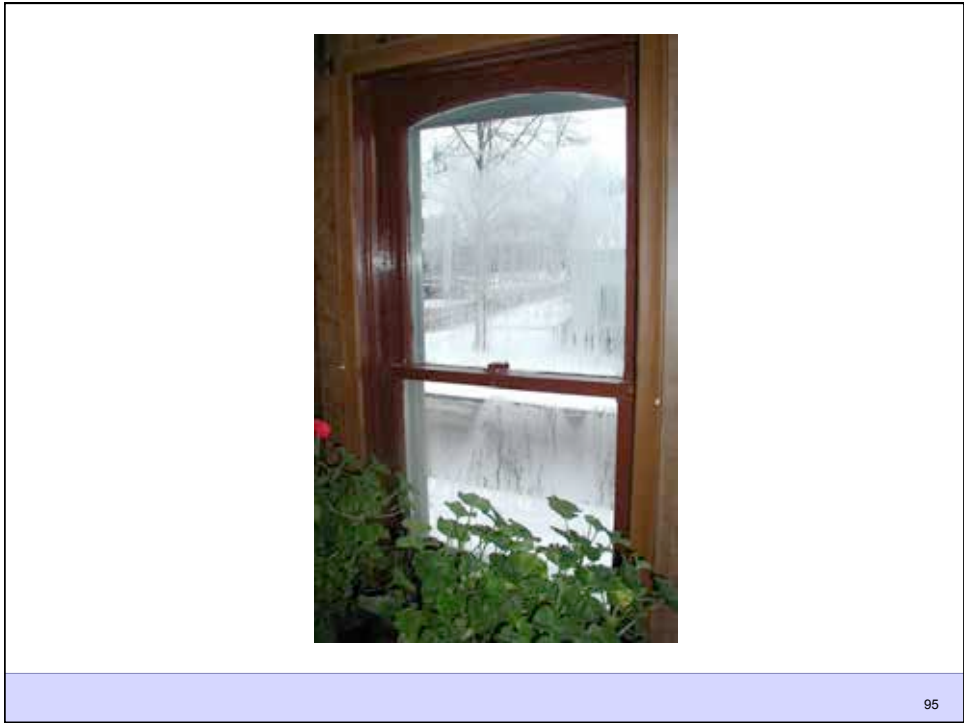

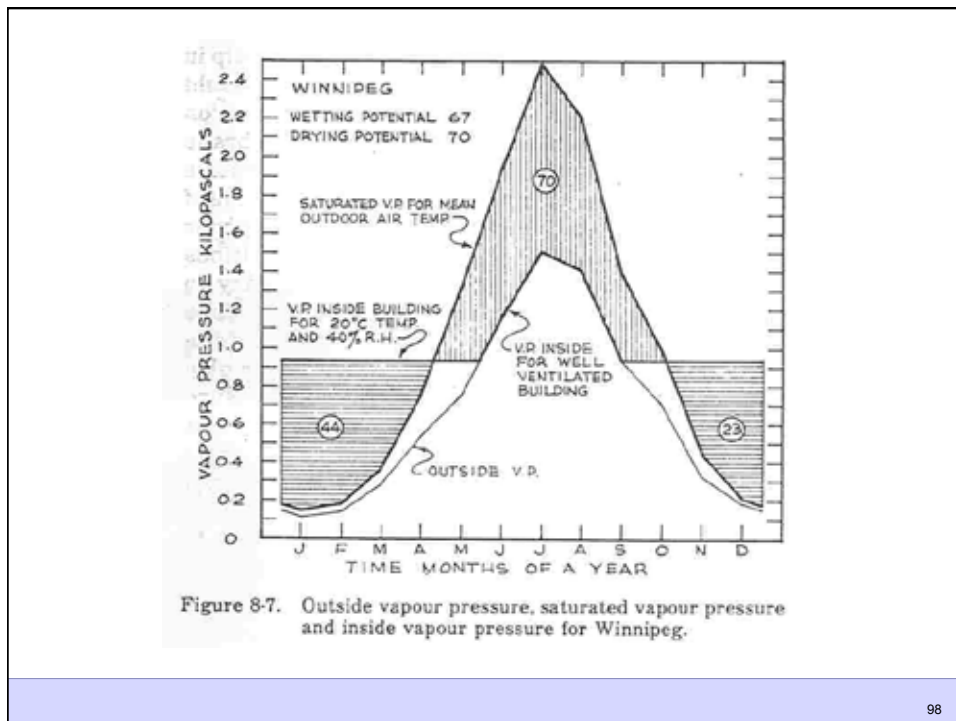
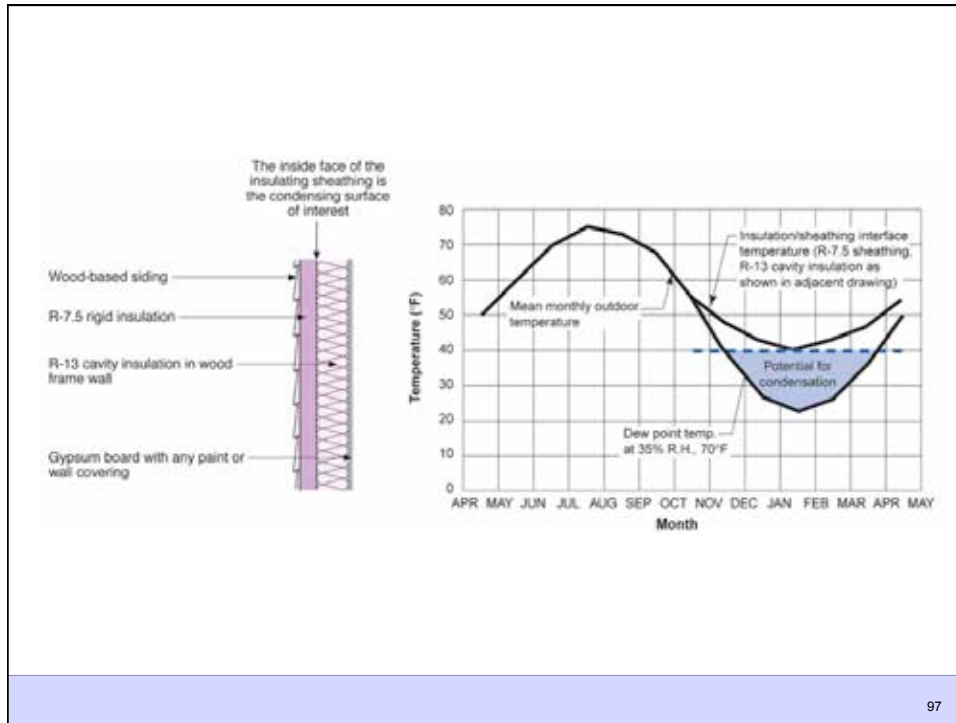

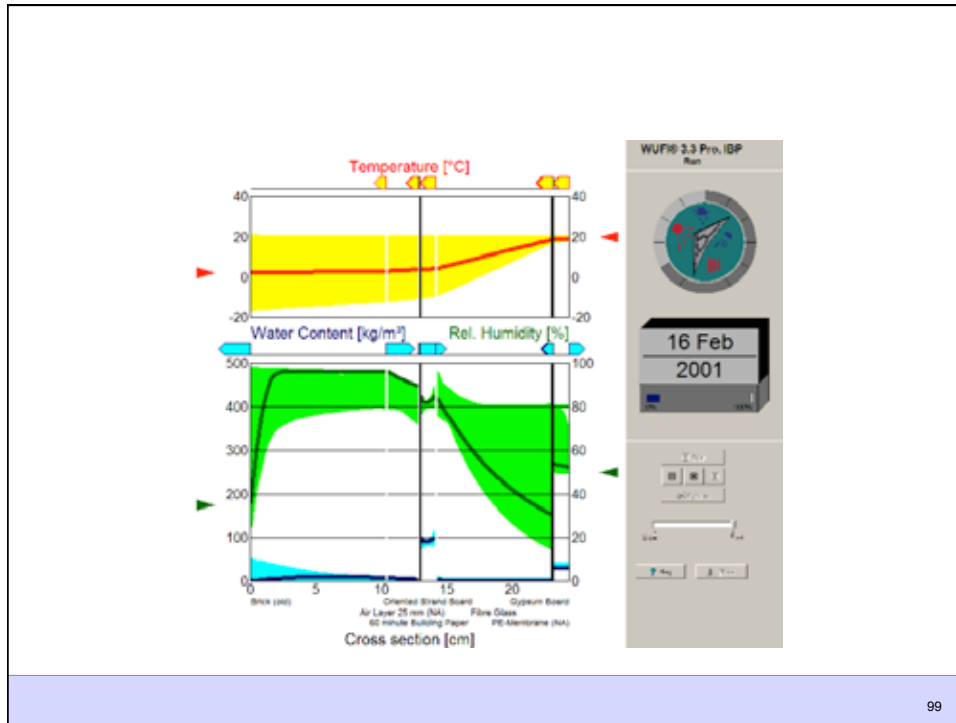

TABLE 1 Ratio of continuous insulation to cavity insulation.

IECC CLIMATE ZONE	MINIMUM CONTINUOUS INSULATION/CAVITY INSULATION RATIO
Marine 4	0.2
5	0.35
6	0.5
7	0.7
8	0.95

The table is adapted from the International Building Code (IBC) and International Residential Code (IRC) and specifies the minimum ratio of the thermal resistance of continuous insulation to cavity insulation based on climate zones as specified by the International Energy Conservation Code (IECC) and referenced by the IBC for commercial and retail enclosures and the IRC for residential enclosures.

QUESTIONS?

Joseph Lstiburek, Ph.D., P.Eng, ASHRAE Fellow

Continuous Insulation

Best Practices

IAC07A | 1 AIA HSW/LU CE Hour

www.buildingscience.com