

Joseph Lstiburek, Ph.D., P.Eng, ASHRAE Fellow

Building Science

Adventures In Building Science

www.buildingscience.com

A Building is an Environmental Separator

Building Science Corporation

Joseph Lstiburek 2

- Water Control Layer
- Air Control Layer
- Vapor Control Layer
- Thermal Control Layer

Building Science Corporation

Joseph Lstiburek 3

2nd Law of Thermodynamics

Building Science Corporation

Joseph Lstiburek 4

Heat Flow Is From Warm To Cold
 Moisture Flow Is From Warm To Cold
 Moisture Flow Is From More To Less
 Air Flow Is From A Higher Pressure to a
 Lower Pressure
 Gravity Acts Down

Building Science Corporation

Joseph Lstiburek 5



Building Science Corporation

Joseph Lstiburek 6

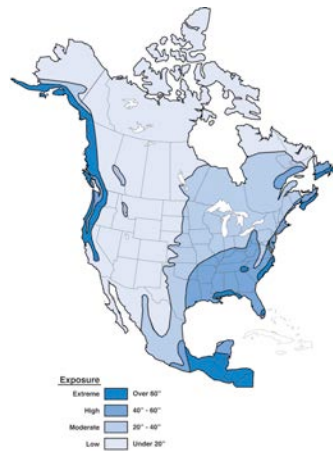

Building Science Corporation

Joseph Lstiburek 7

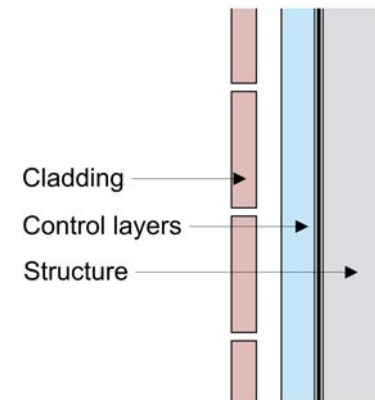

Building Science Corporation

Joseph Lstiburek 8

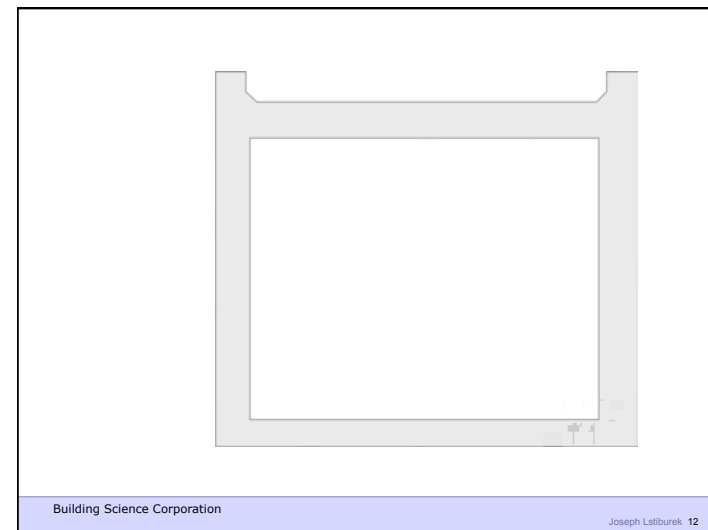
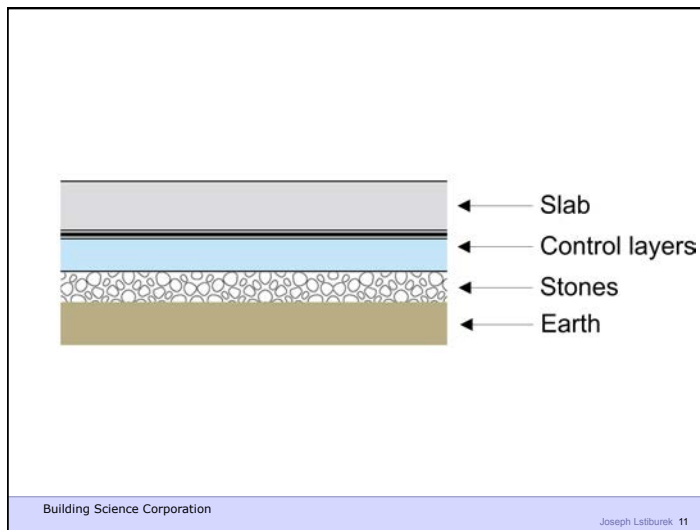
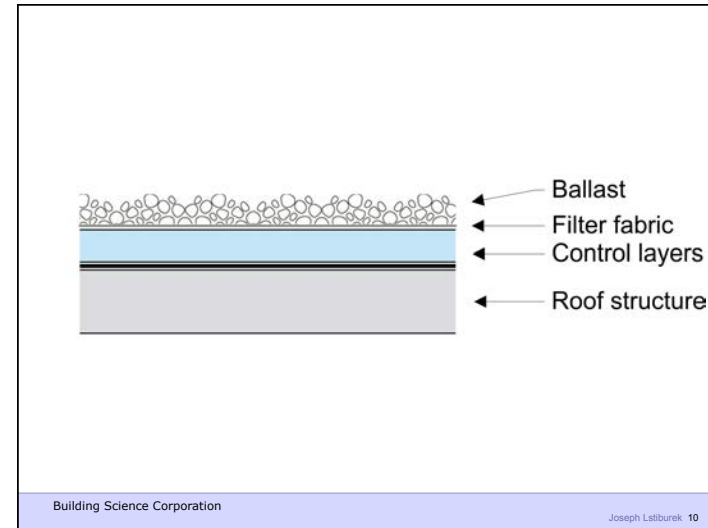
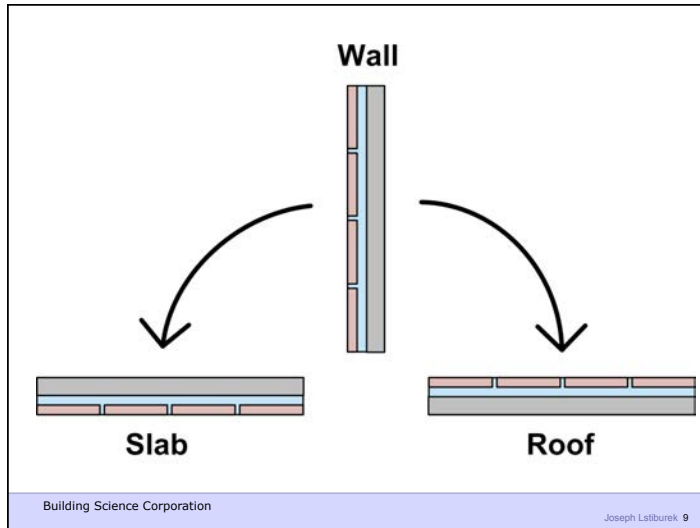

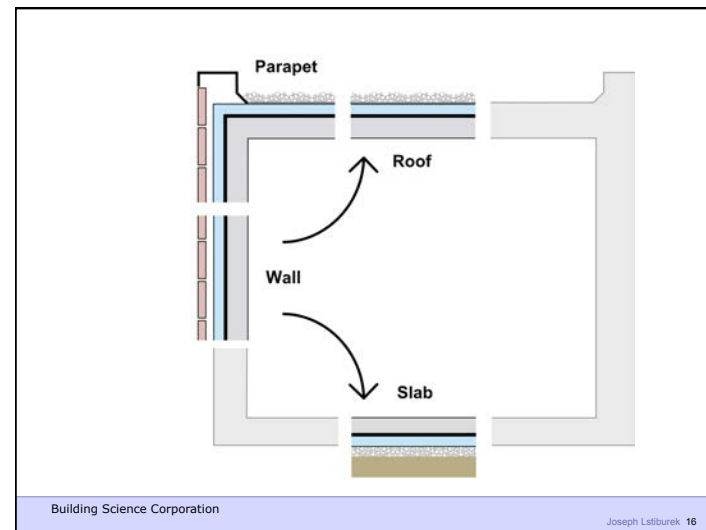
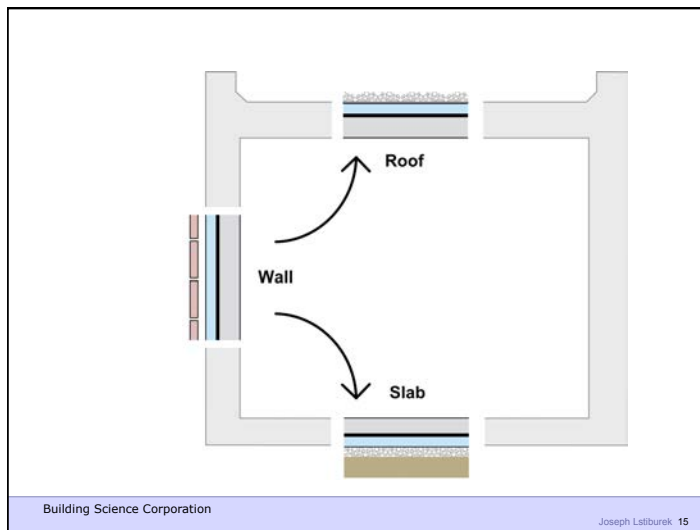
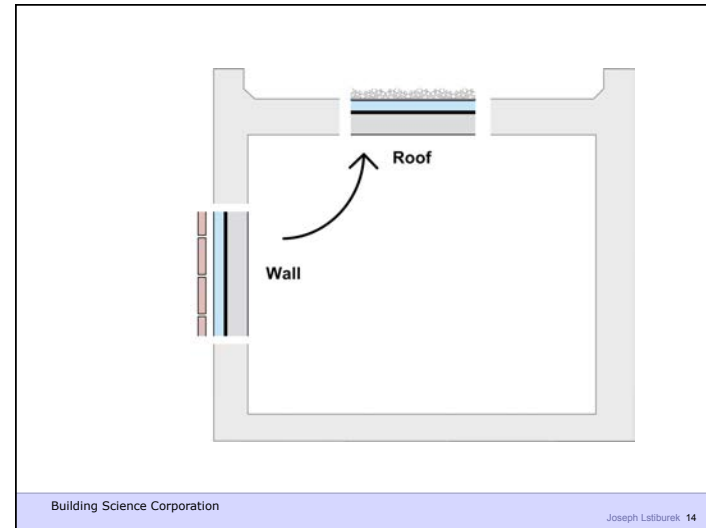
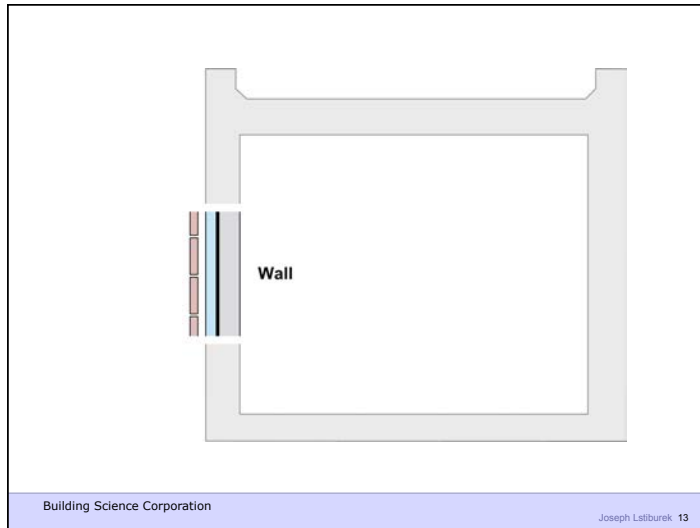

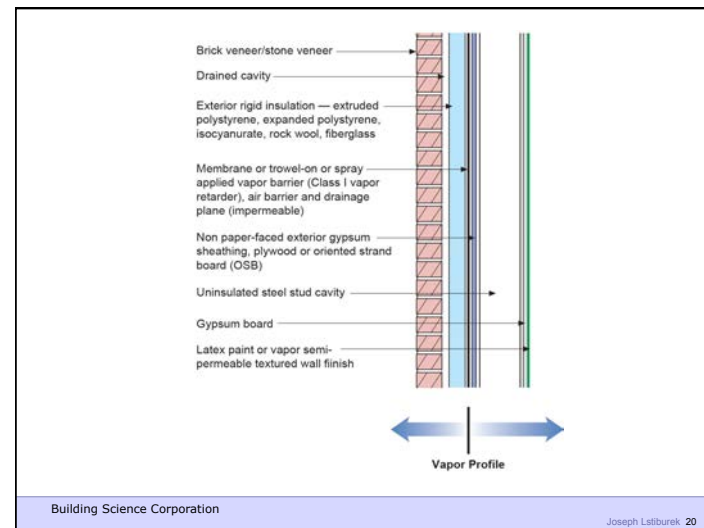
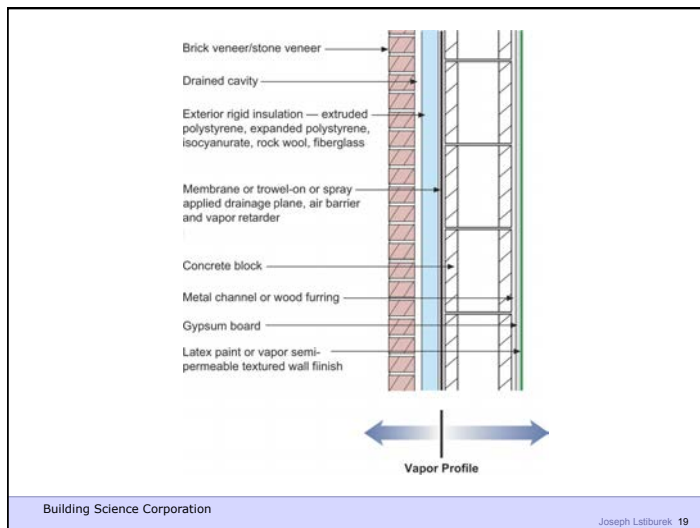
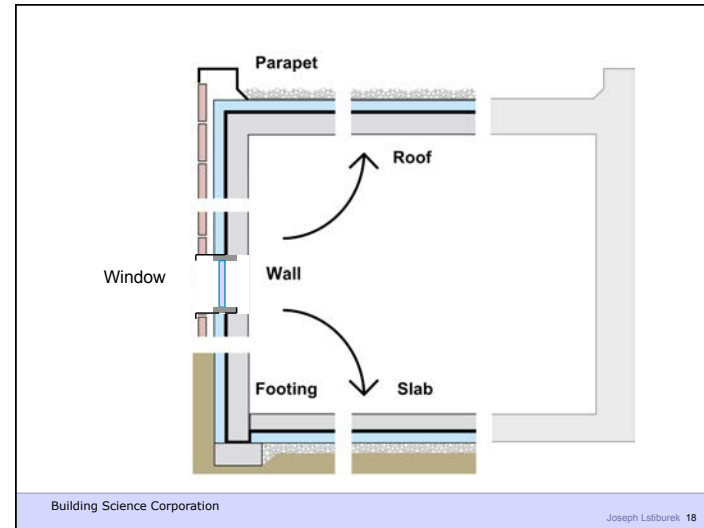
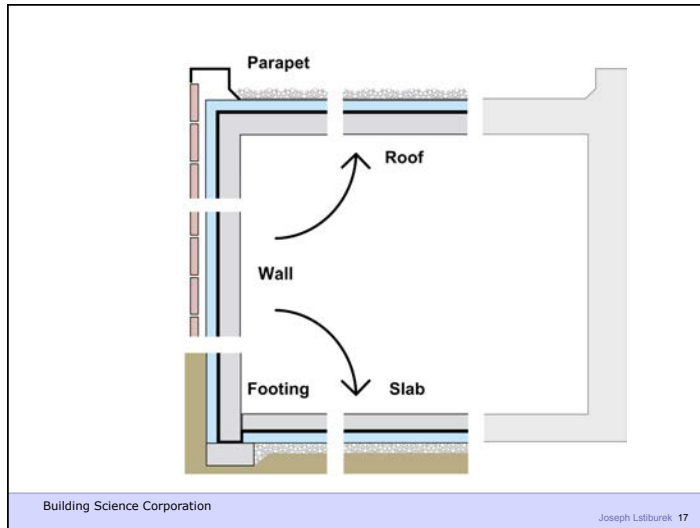

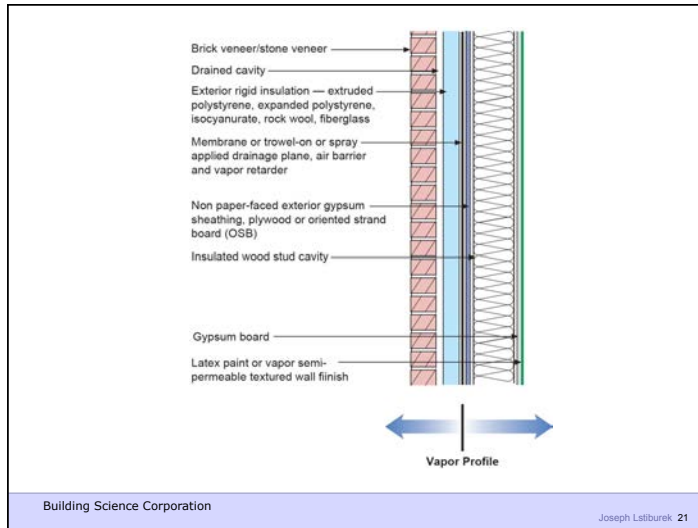

Commercial Enclosure: Simple Layers

- Structure
- Rain/Air/Vapor
- Insulation
- Finish

Building Science Corporation
 Joseph Lstiburek 22

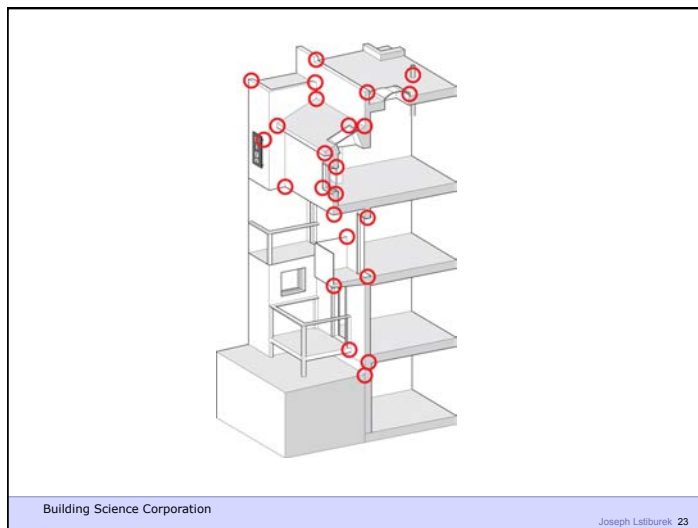

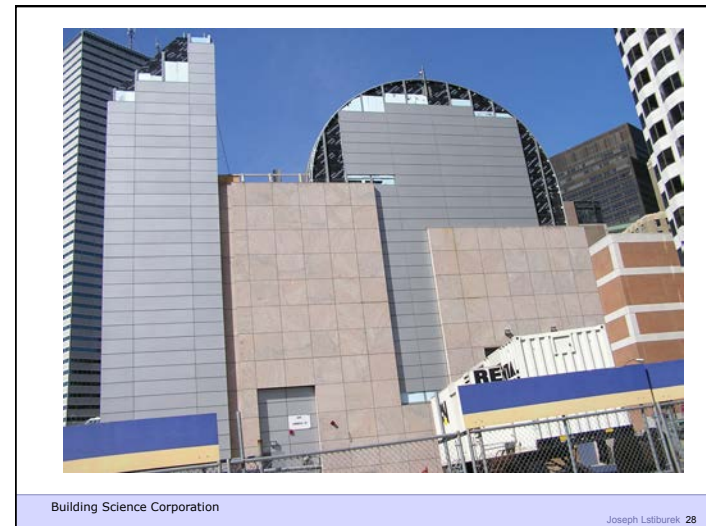
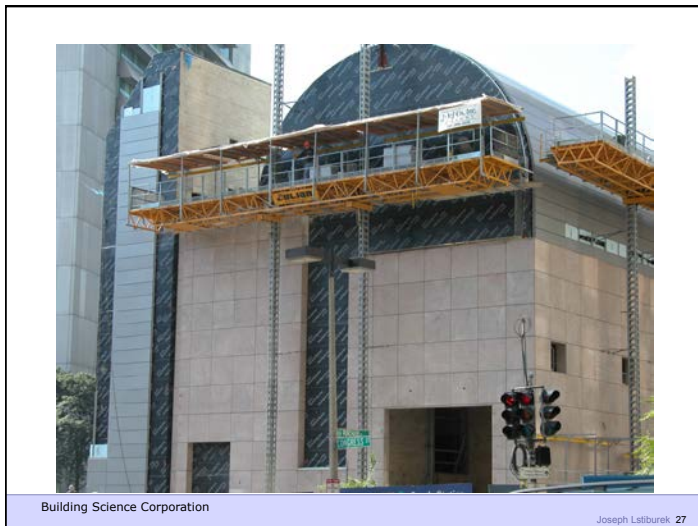

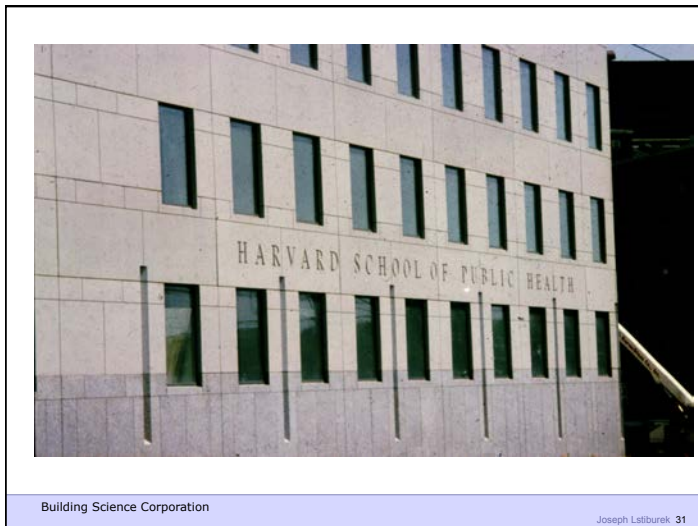

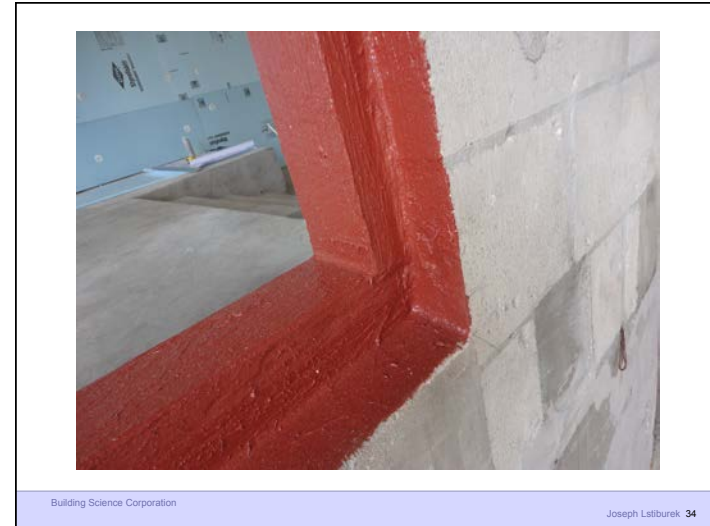

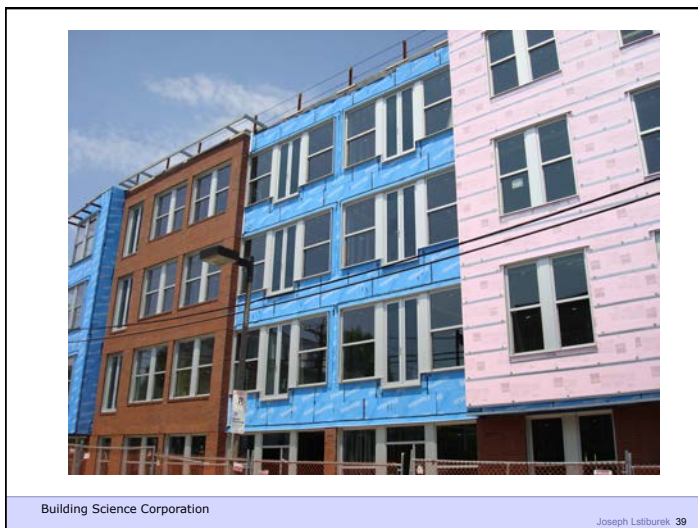
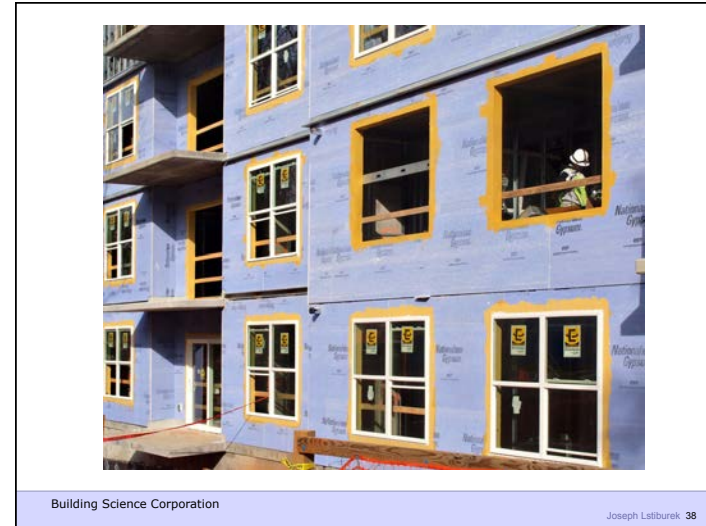

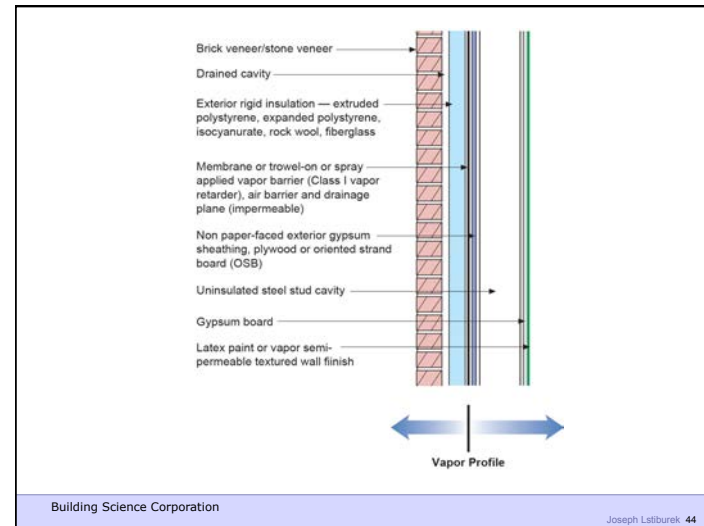
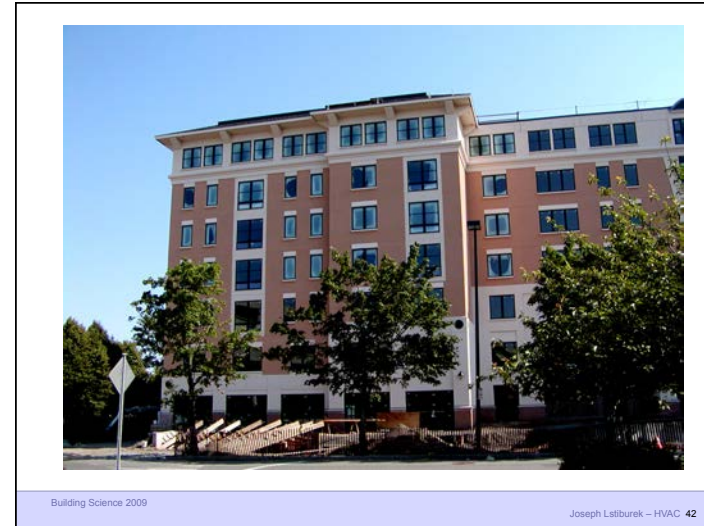
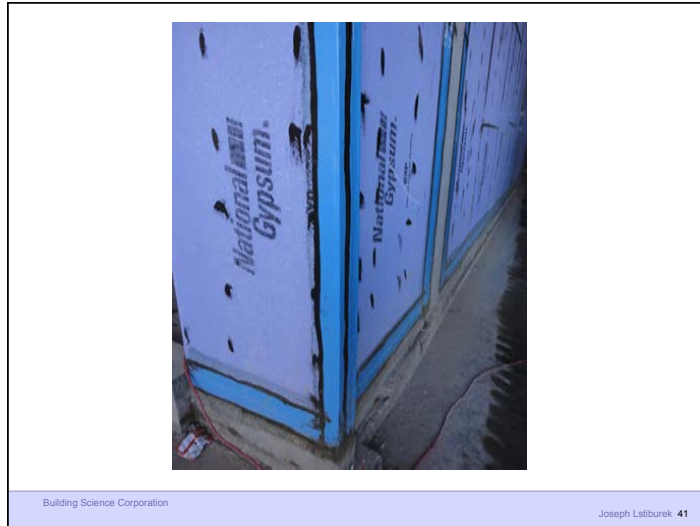

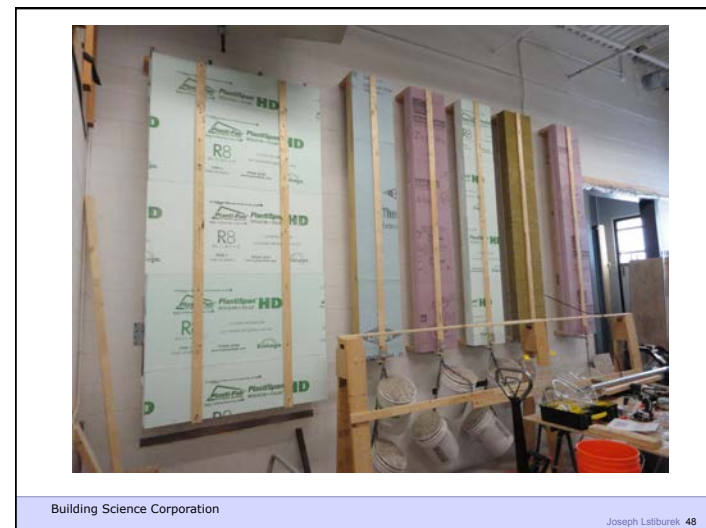
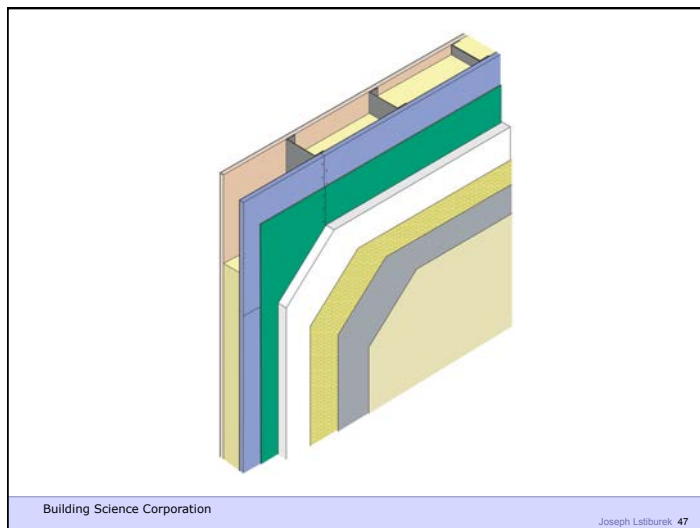
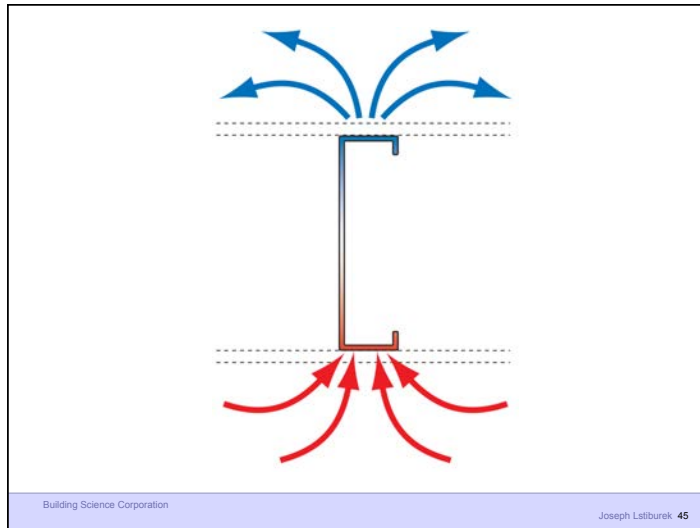

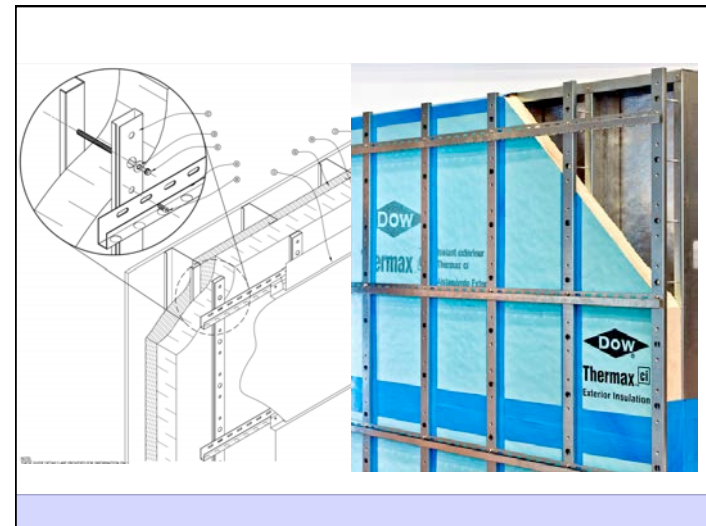
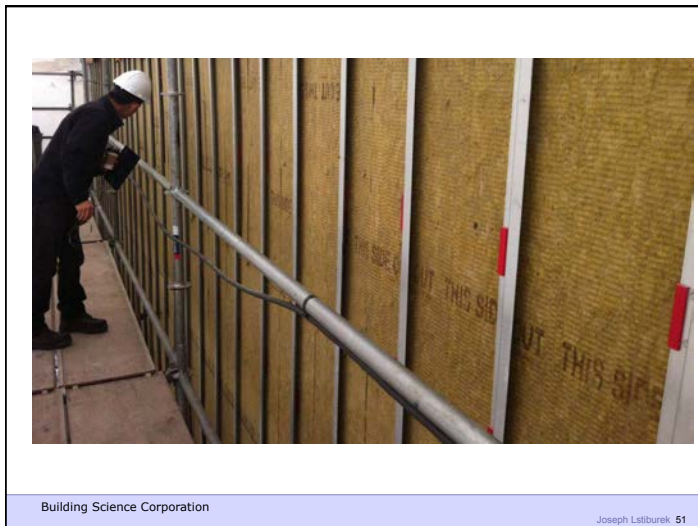
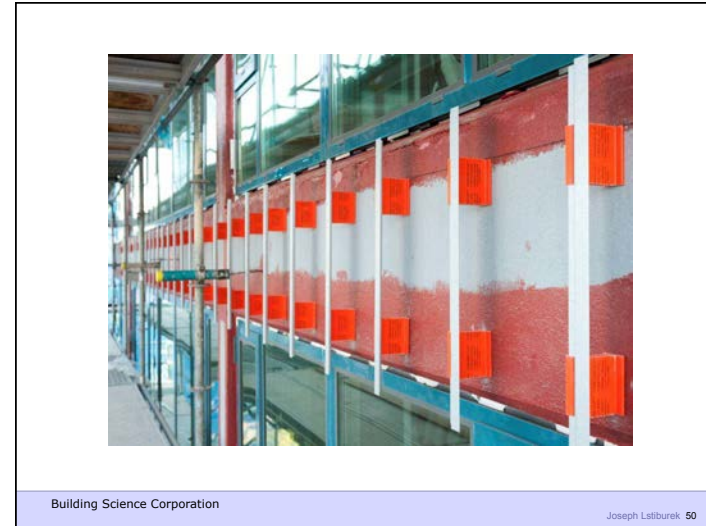

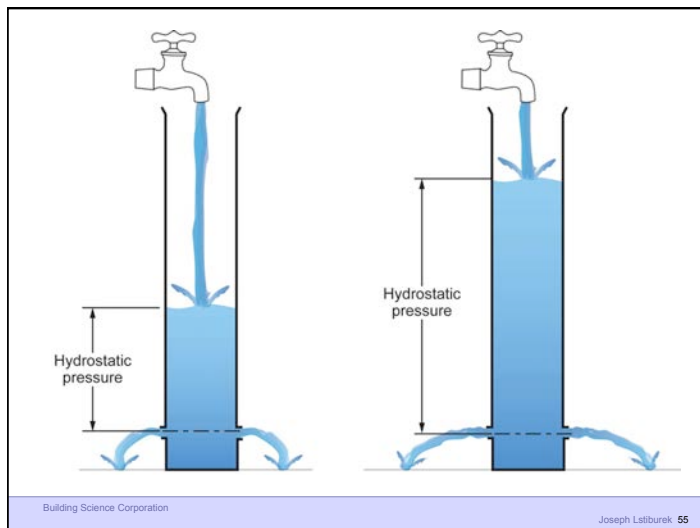
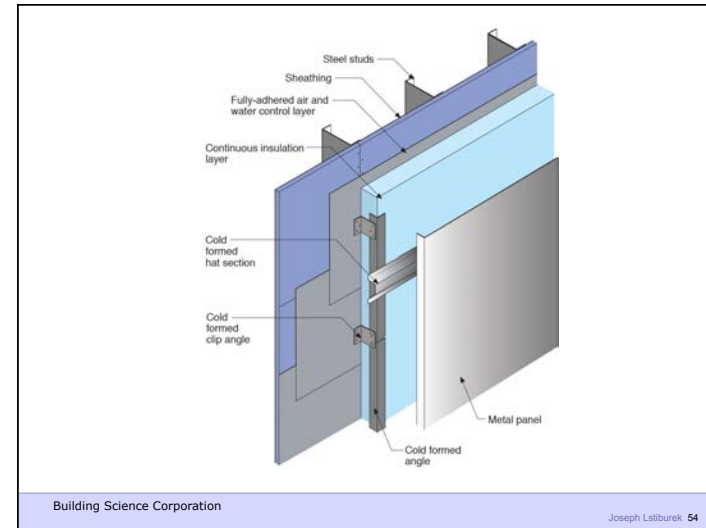
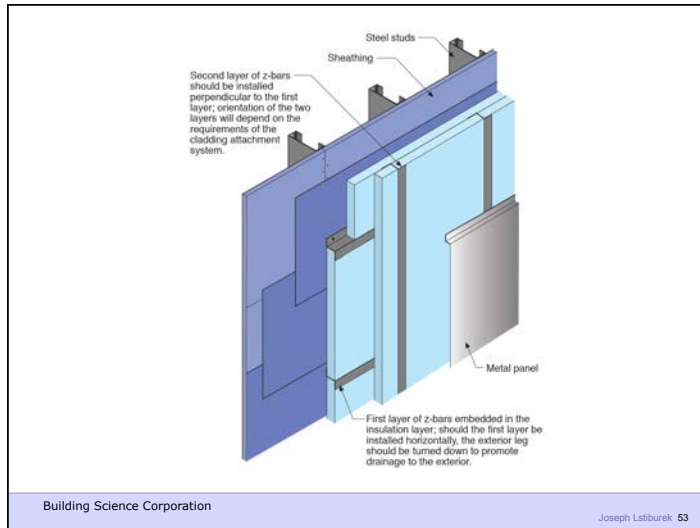

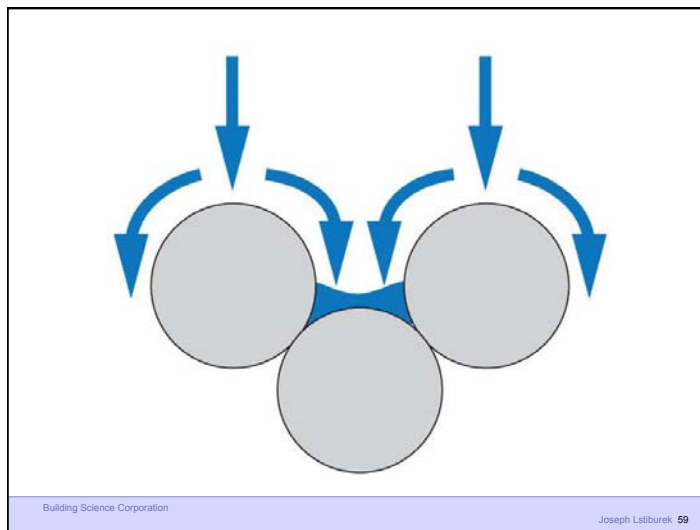
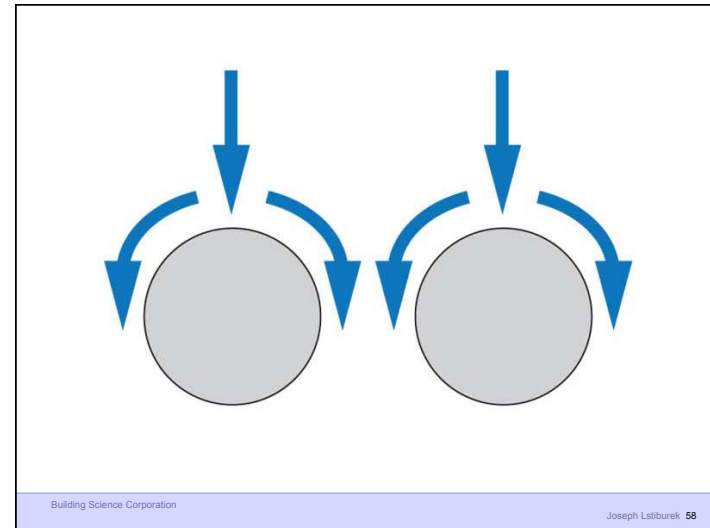
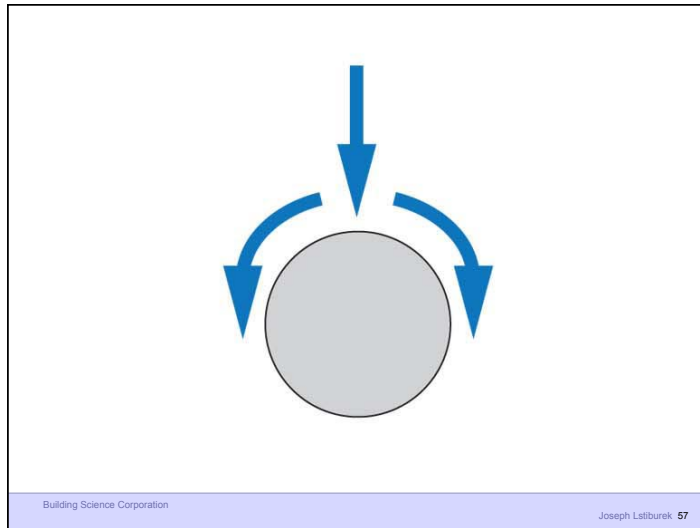

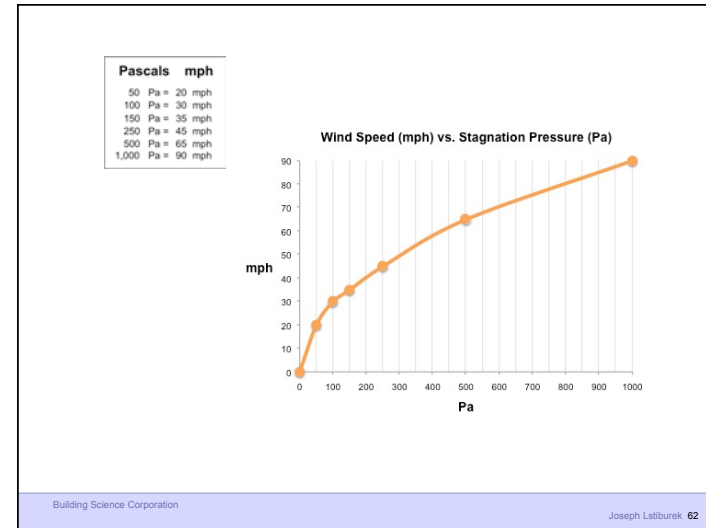
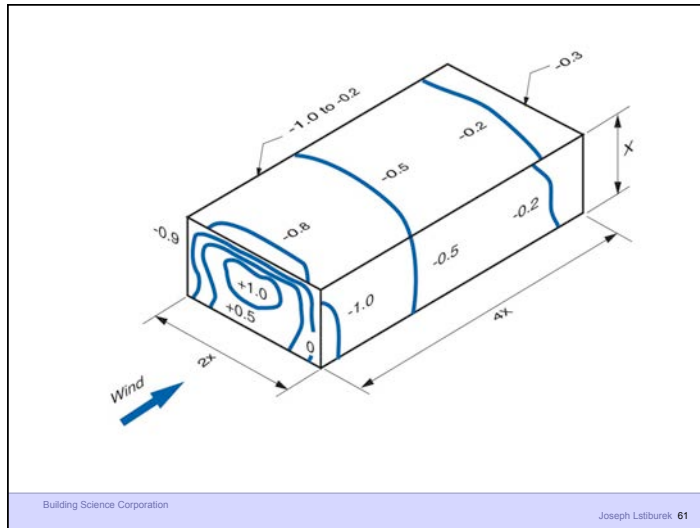

Rain Screen

Building Science Corporation Joseph Lstiburek 65

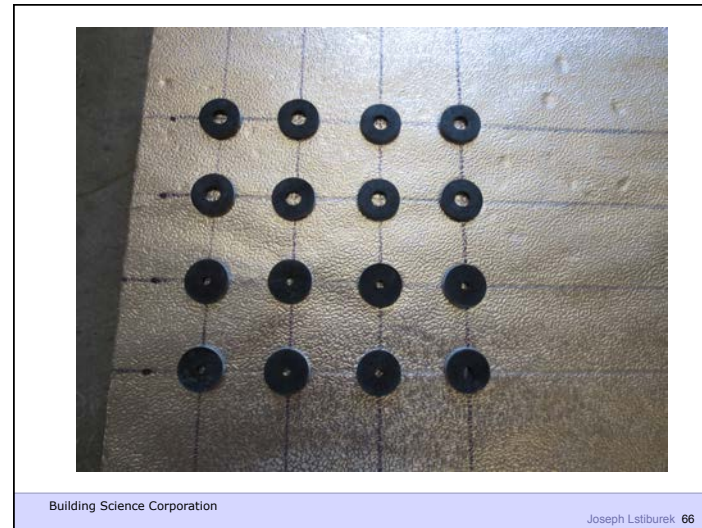

Beer Screen?

Building Science Corporation Joseph Lstiburek 67

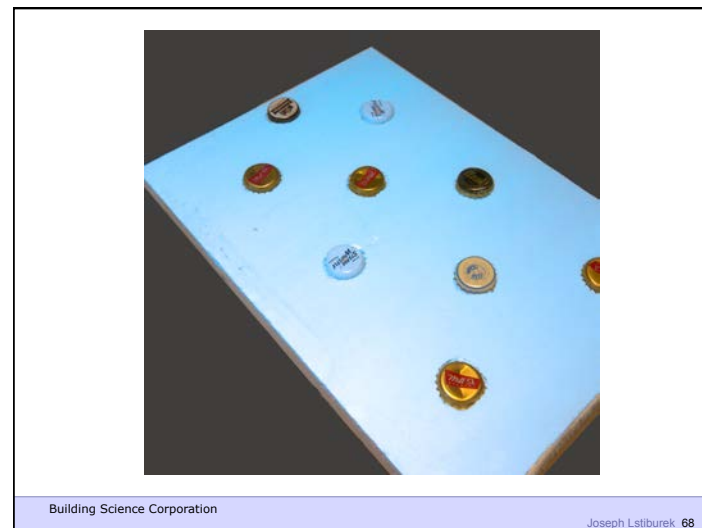

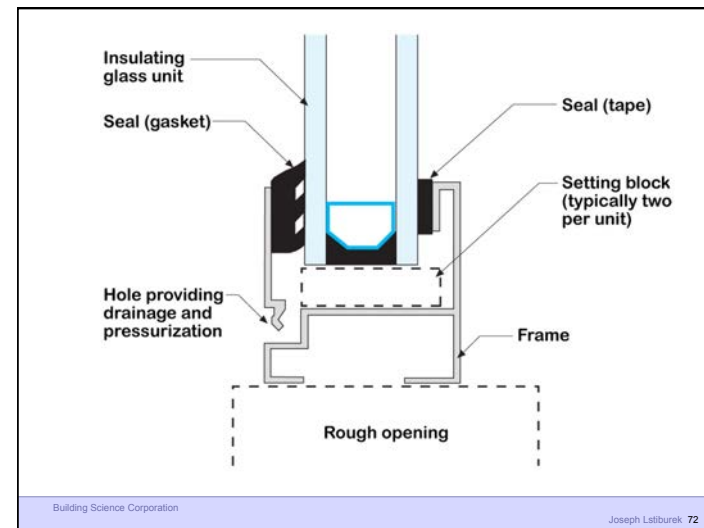
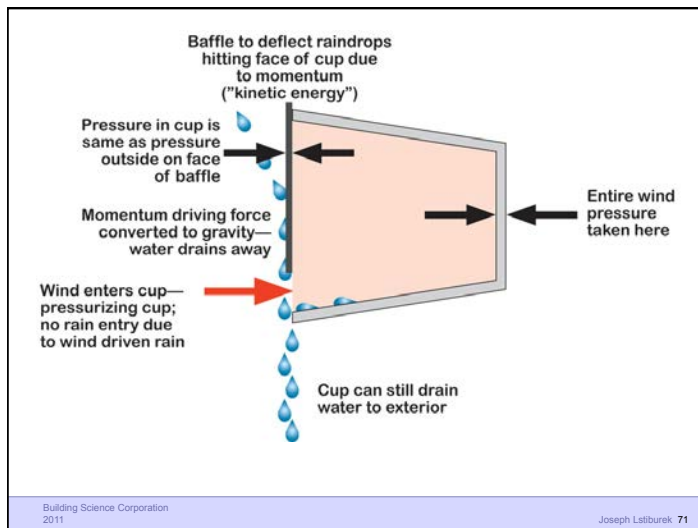
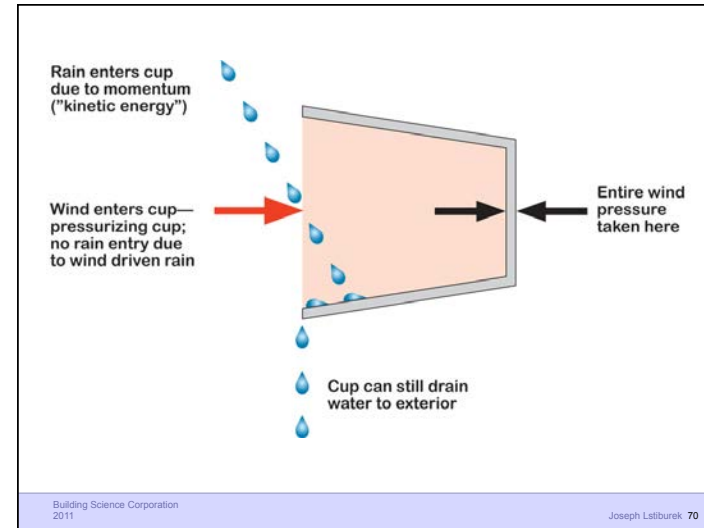
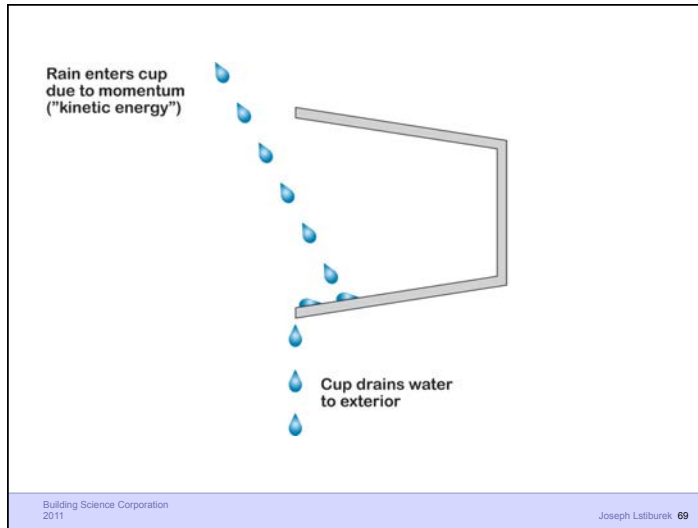

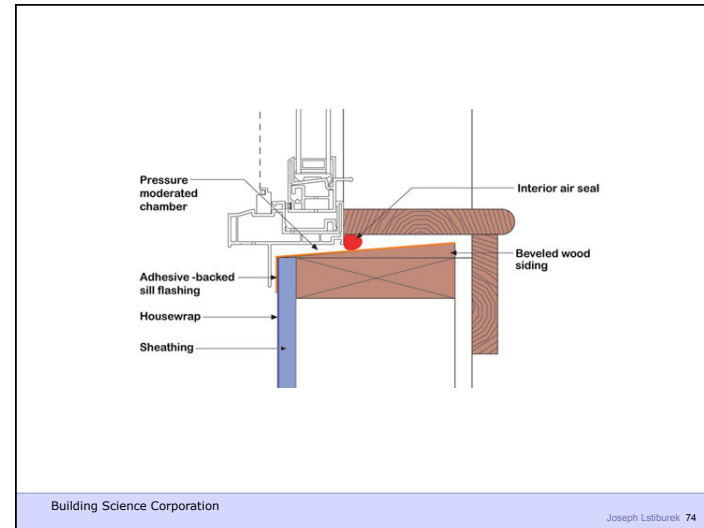
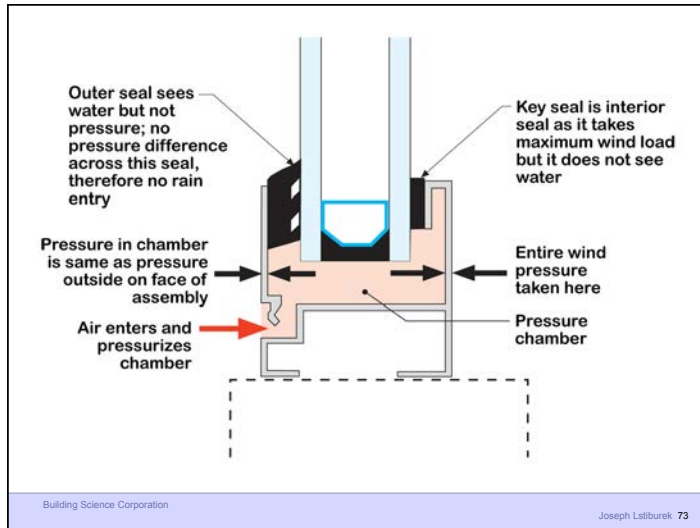

Don't Do Stupid Things

Building Science Corporation Joseph Lstiburek 77

