

Joseph Lstiburek, Ph.D., P.Eng, ASHRAE Fellow

Building Science

Air Flow Control

presented by www.buildingscience.com

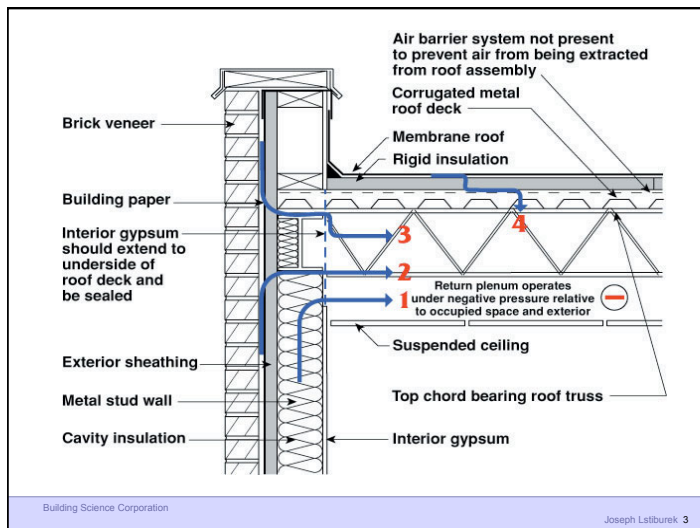
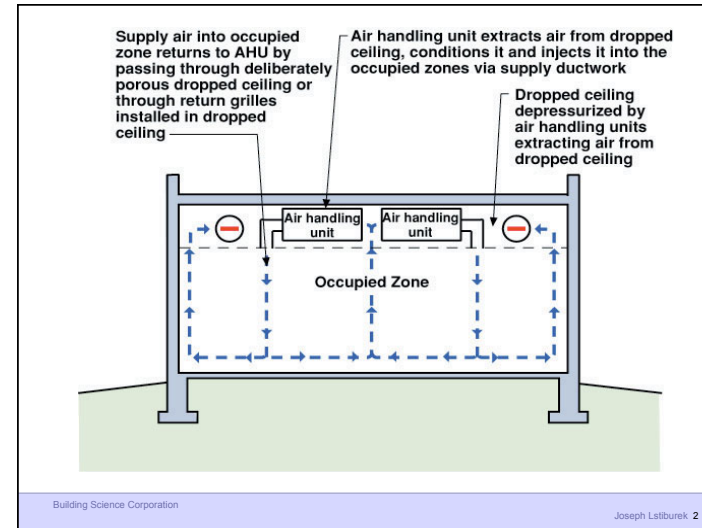

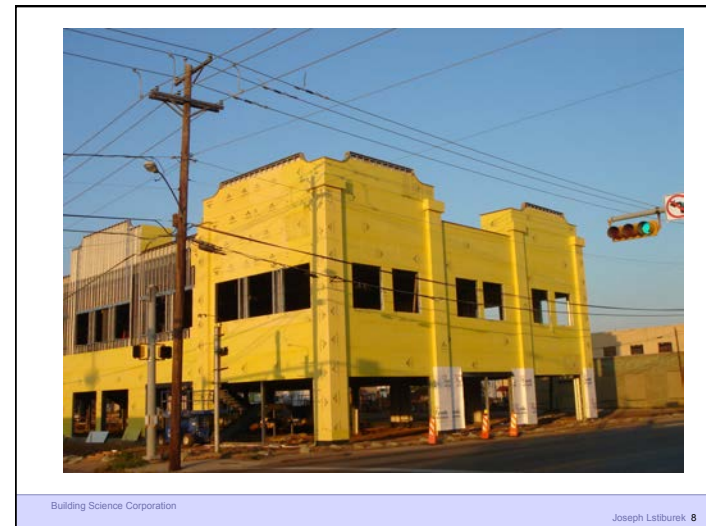
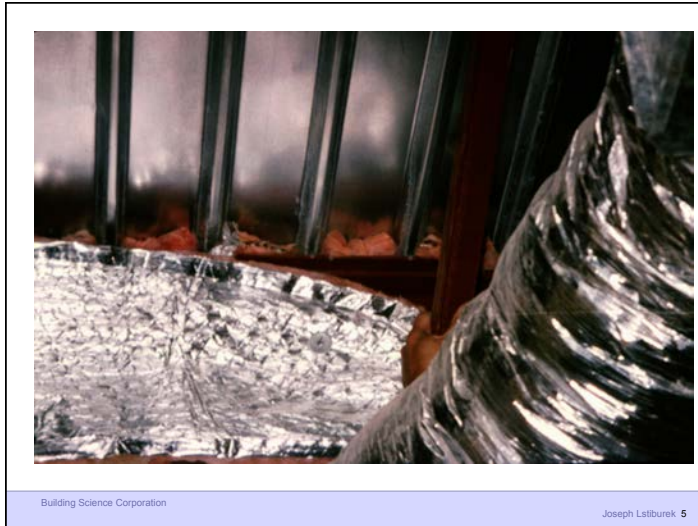

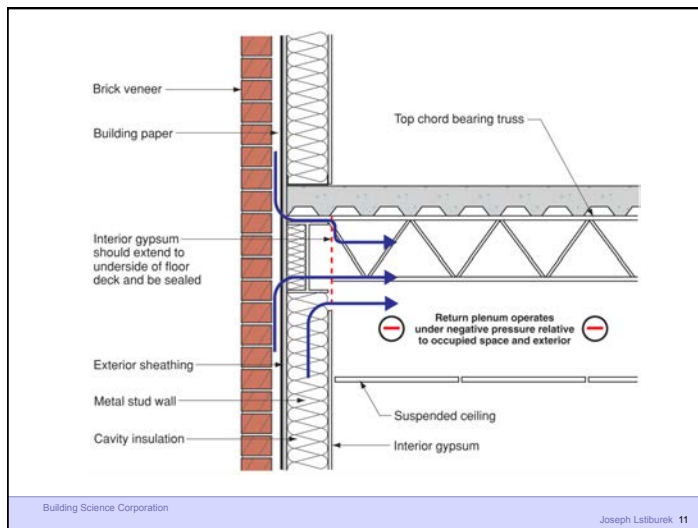
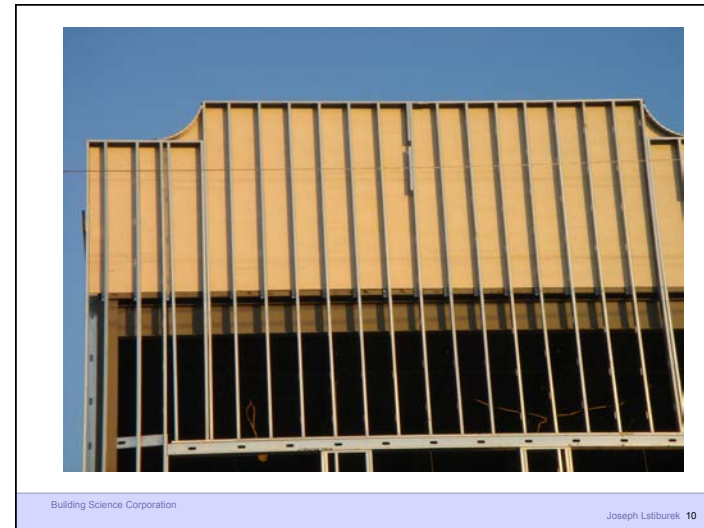
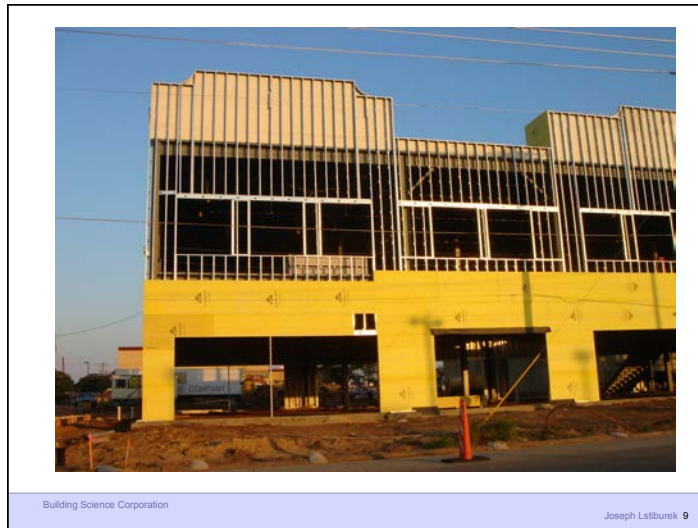

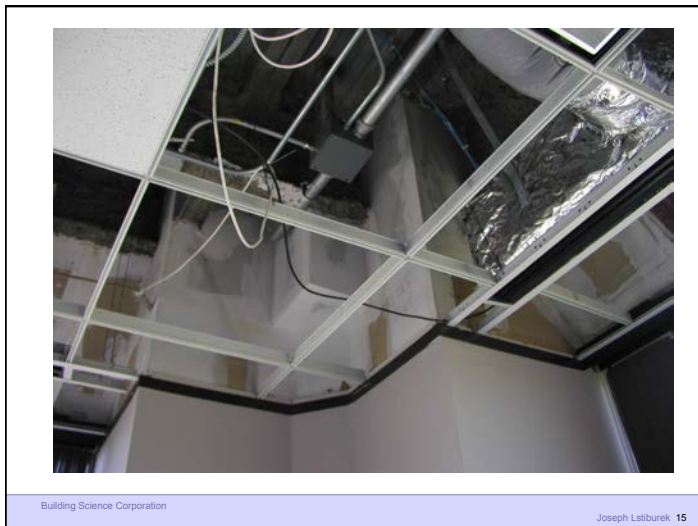
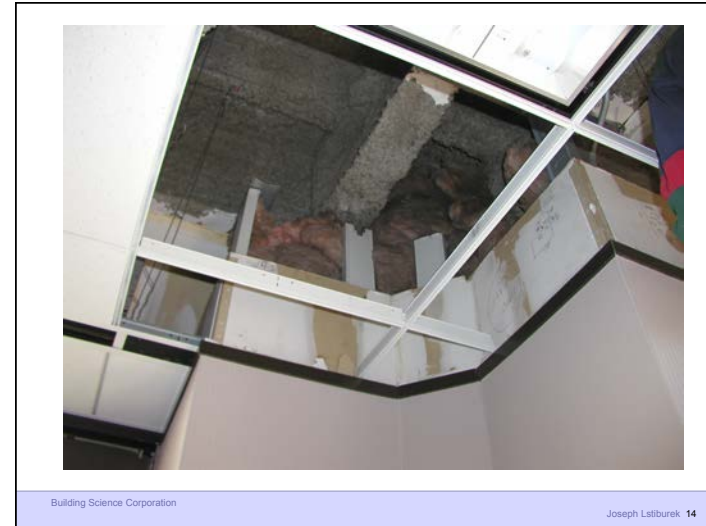
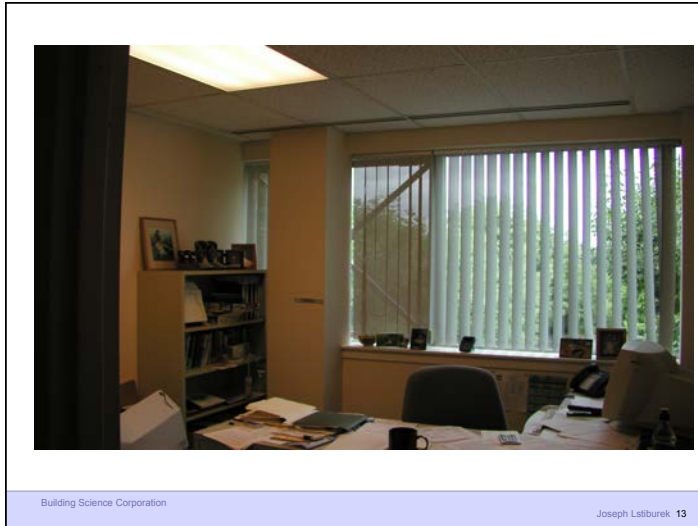



Building Science Corporation

Joseph Lstiburek 17

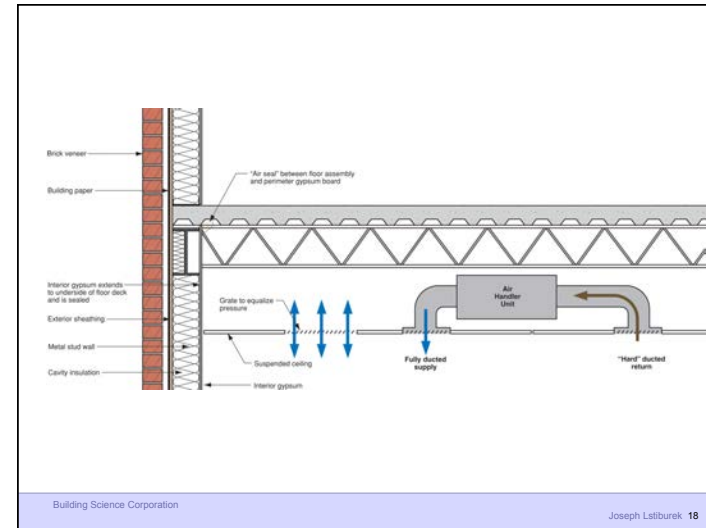

Building Science Corporation

Joseph Lstiburek 18

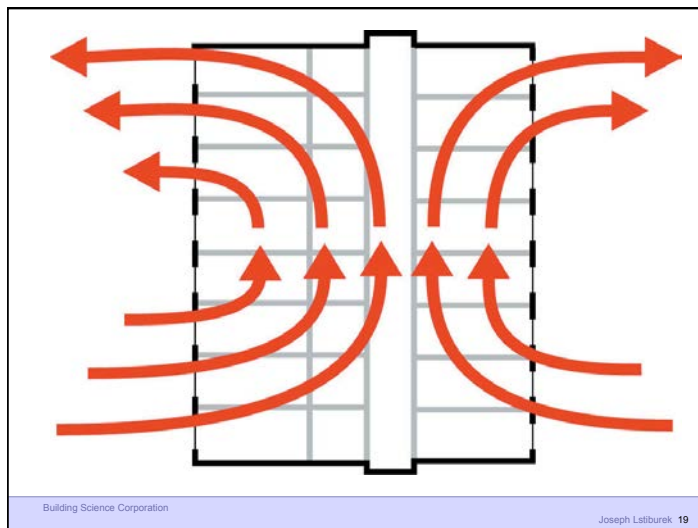

Building Science Corporation

Joseph Lstiburek 19

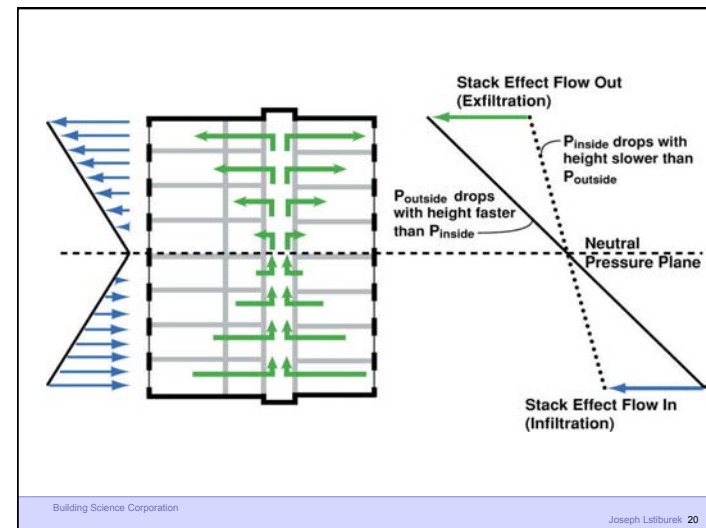

Building Science Corporation

Joseph Lstiburek 20

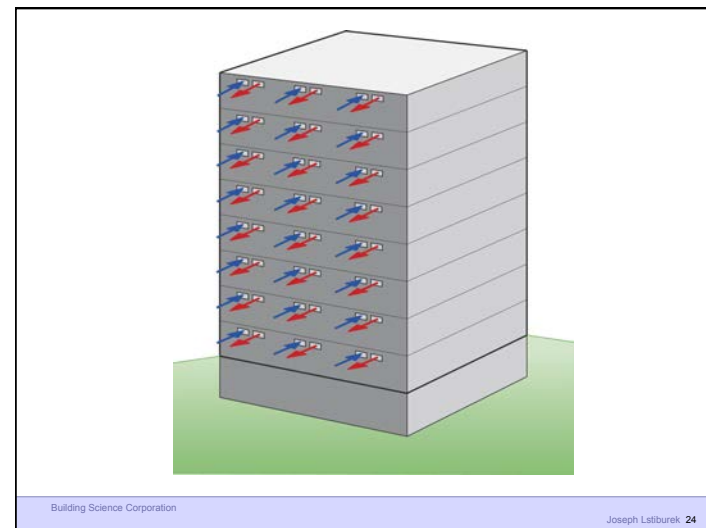
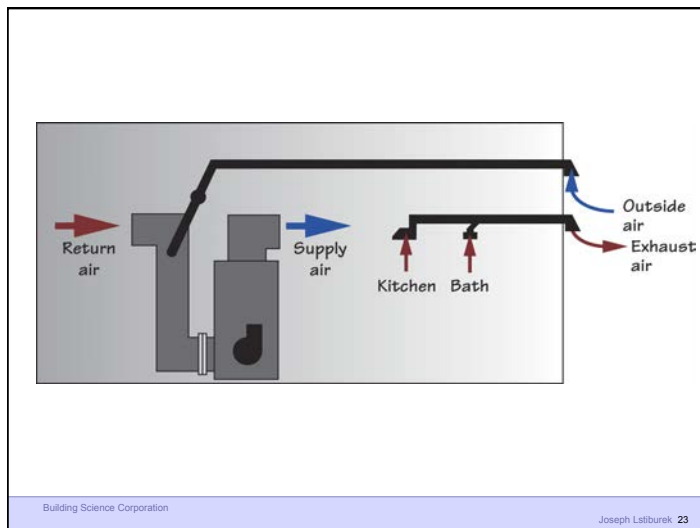
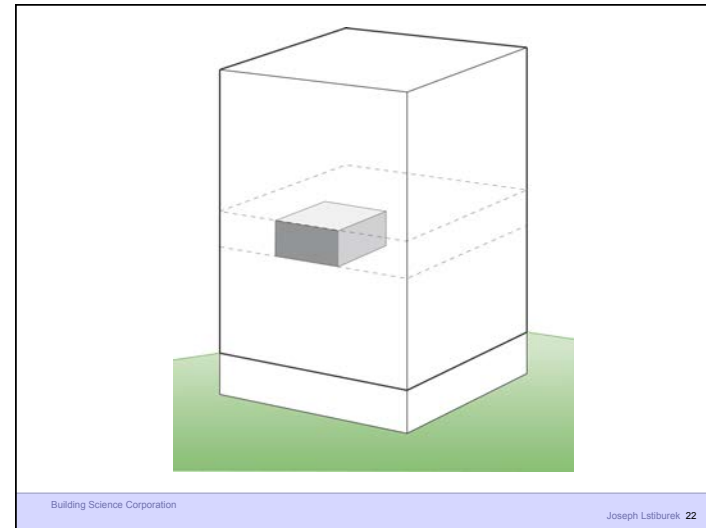
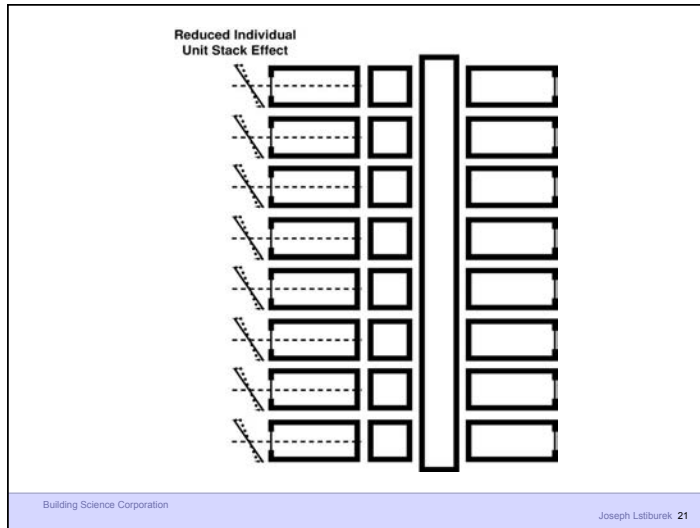

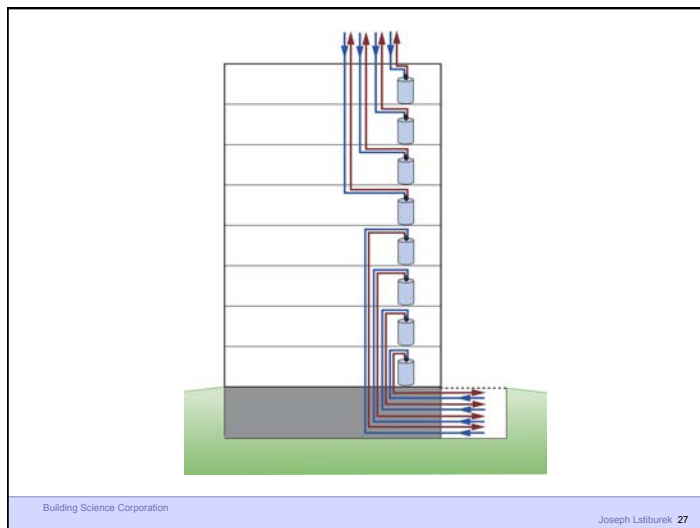
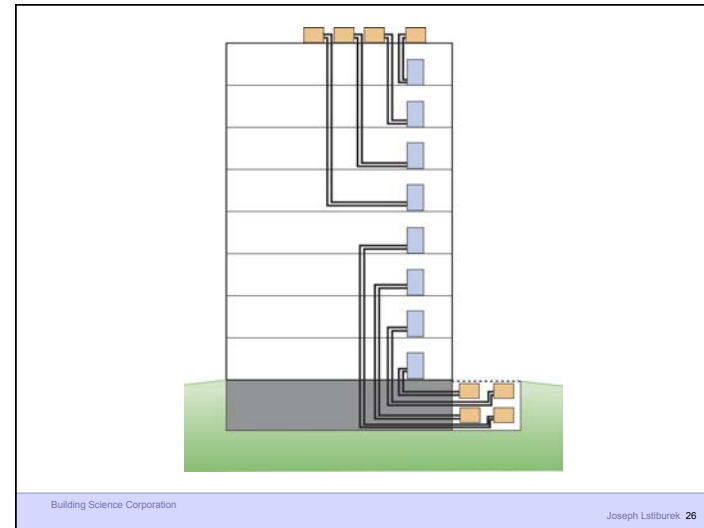
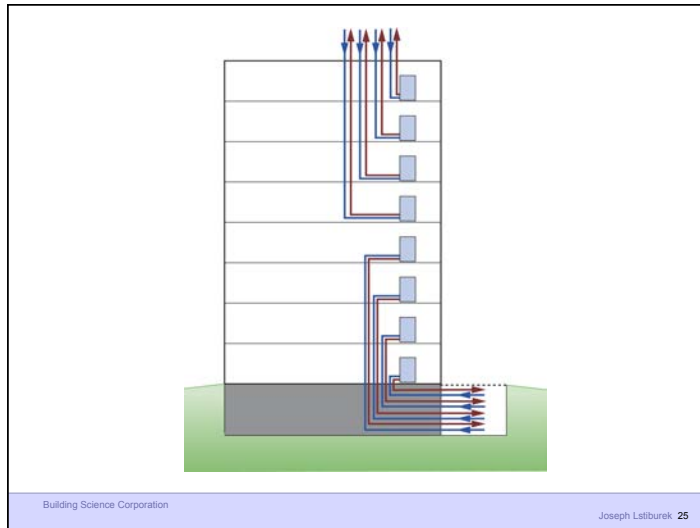

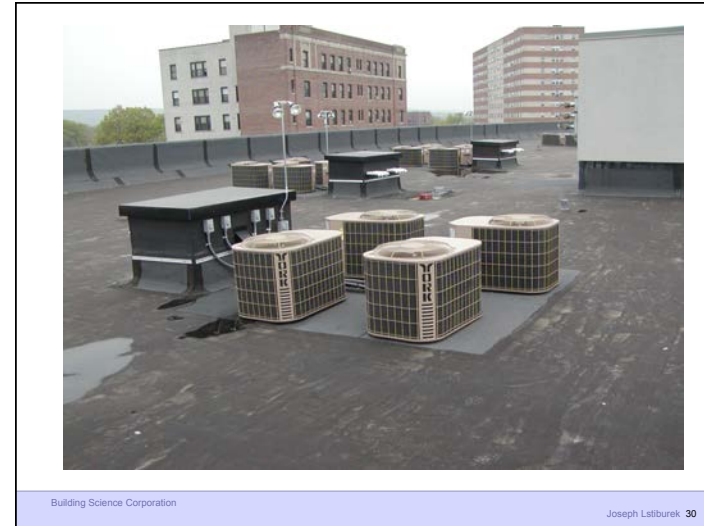
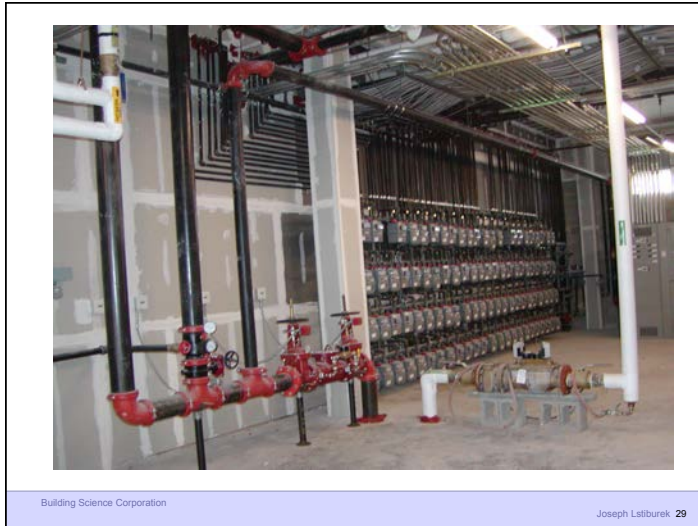

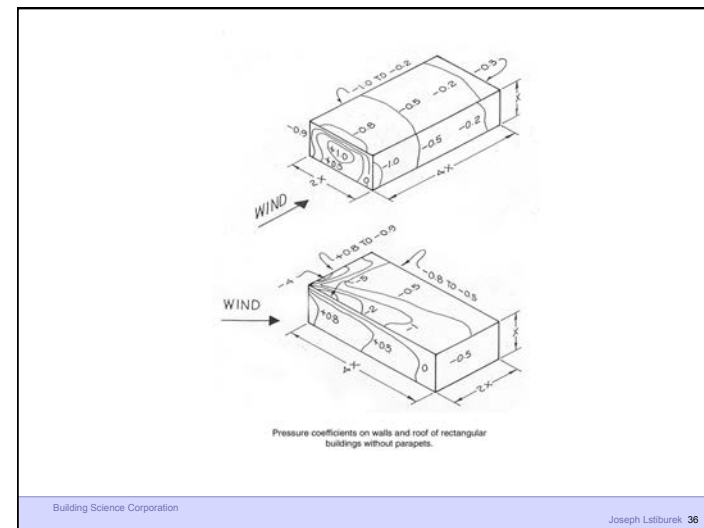
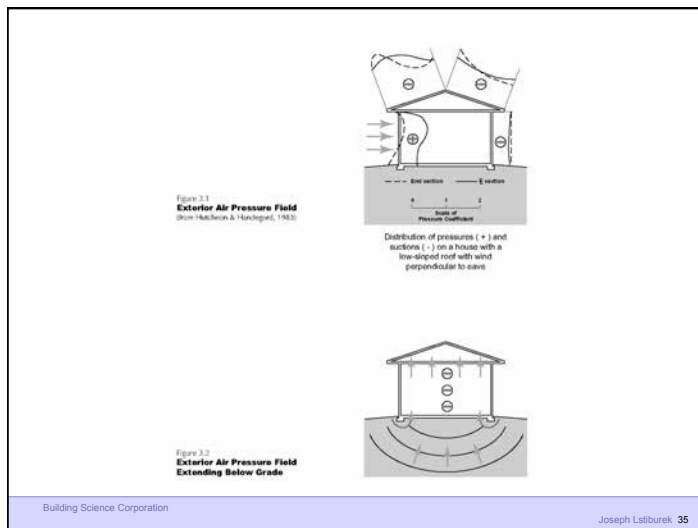
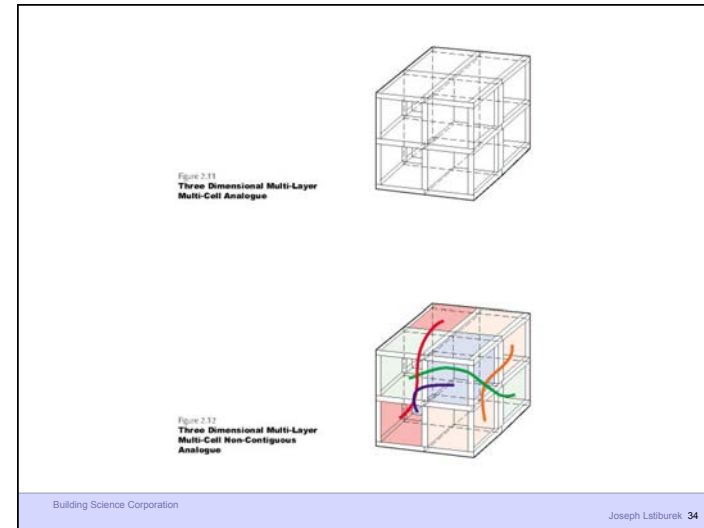
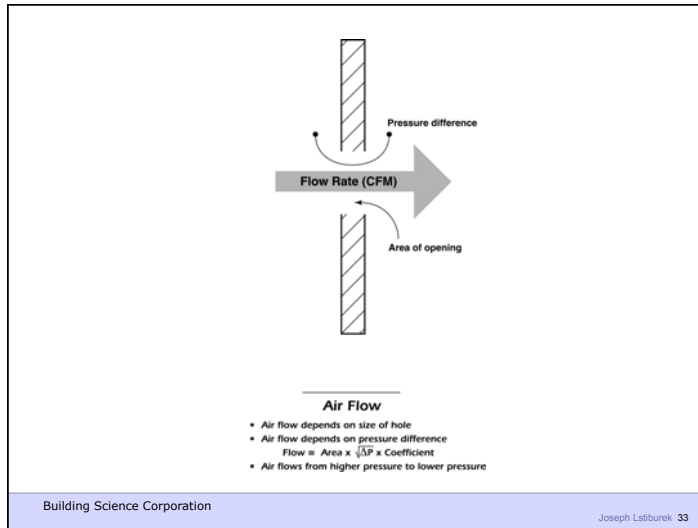

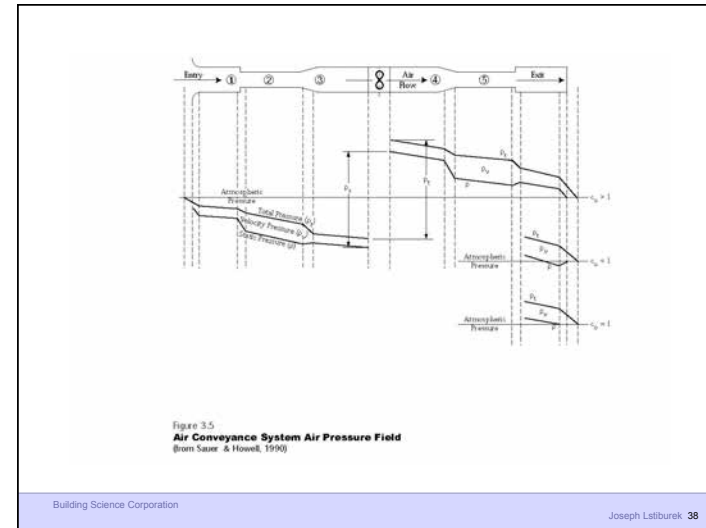
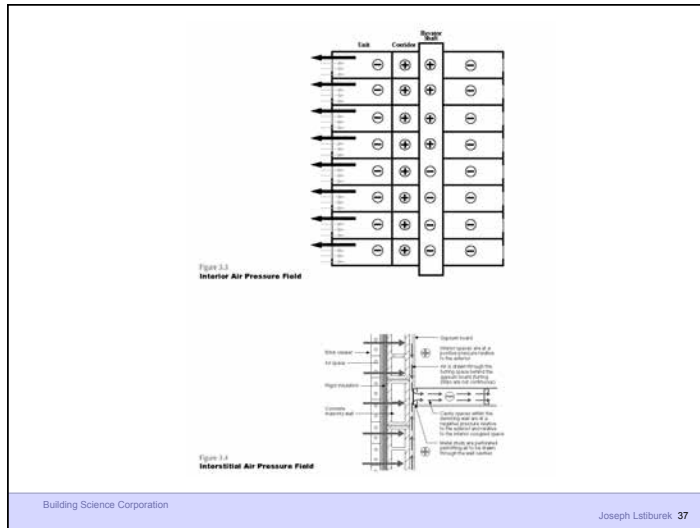

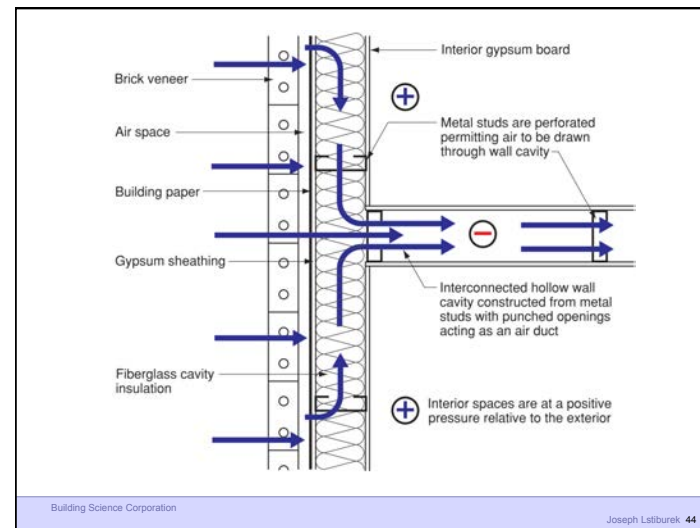
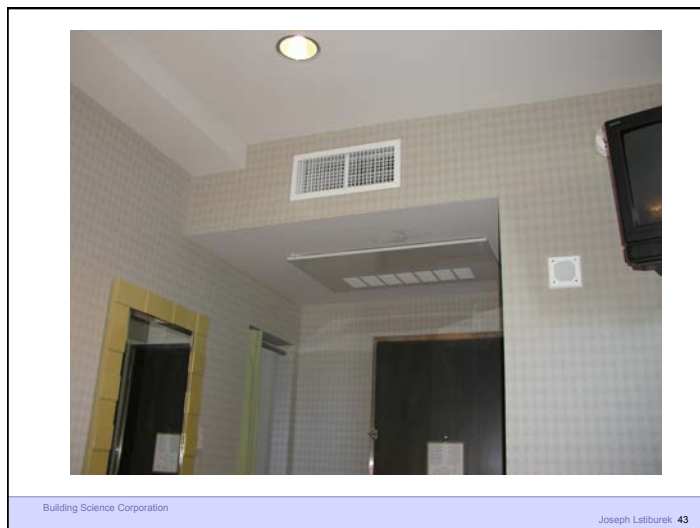
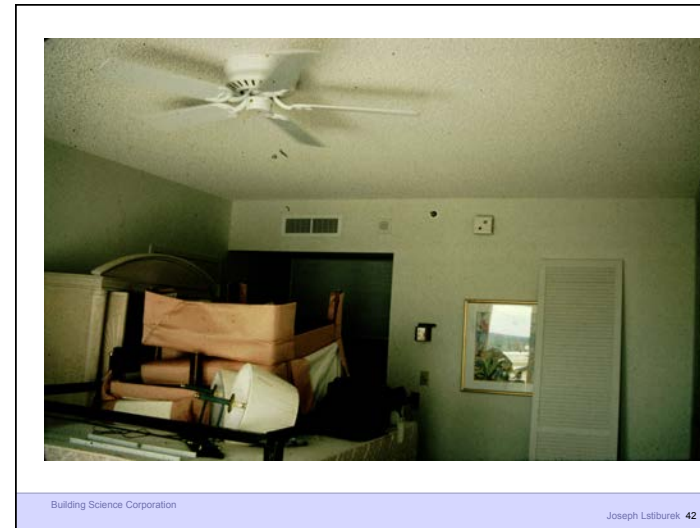
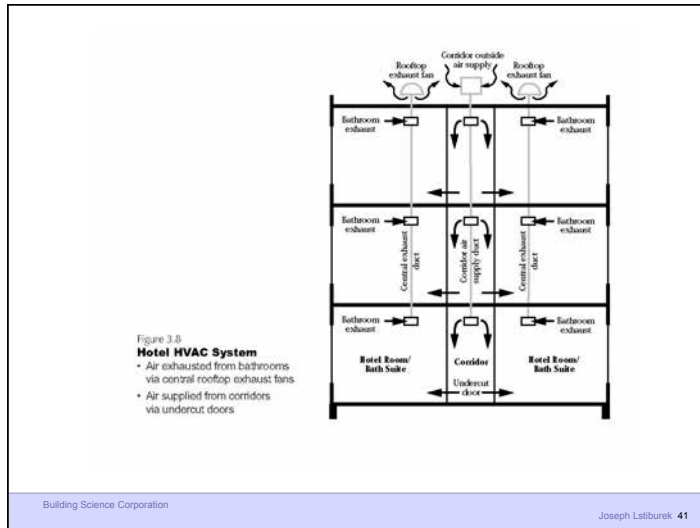

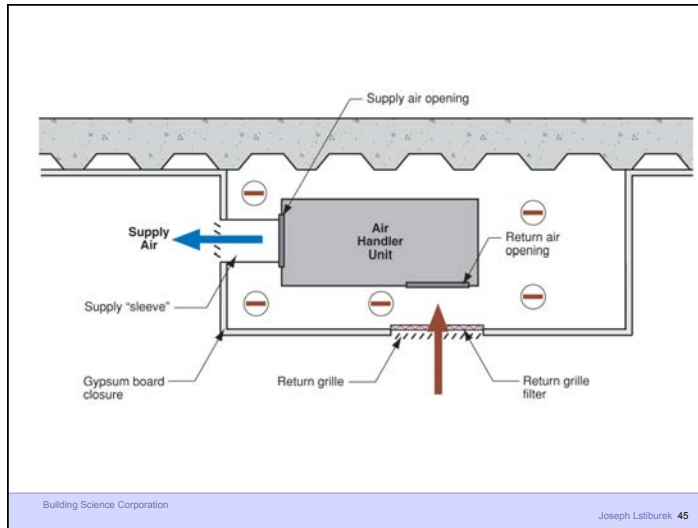

Building Science Corporation

Joseph Lstiburek 45

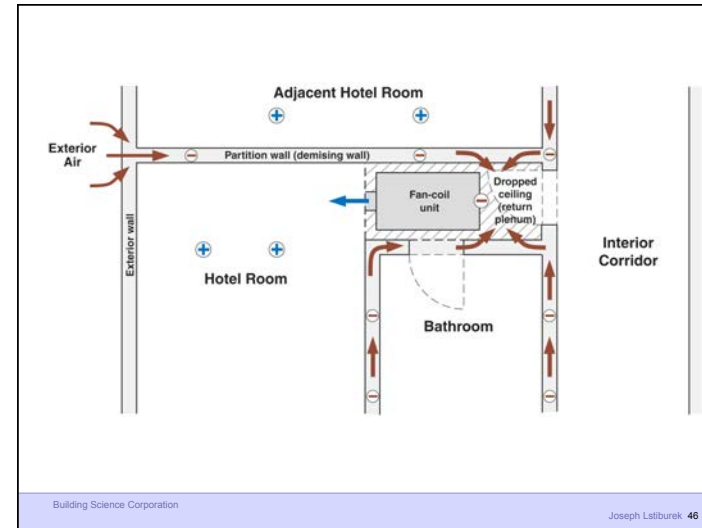

Building Science Corporation

Joseph Lstiburek 46

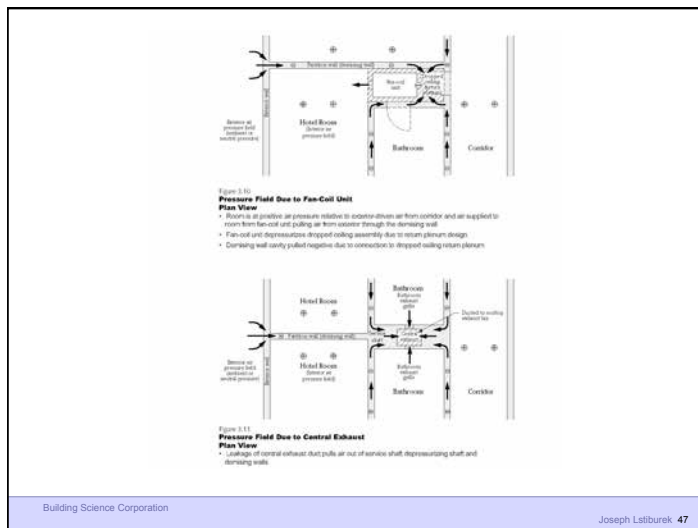

Building Science Corporation

Joseph Lstiburek 47



Building Science Corporation

Joseph Lstiburek 48

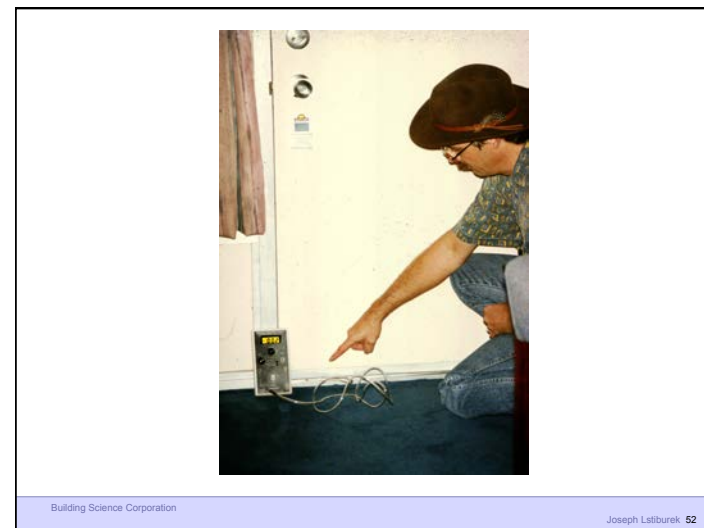
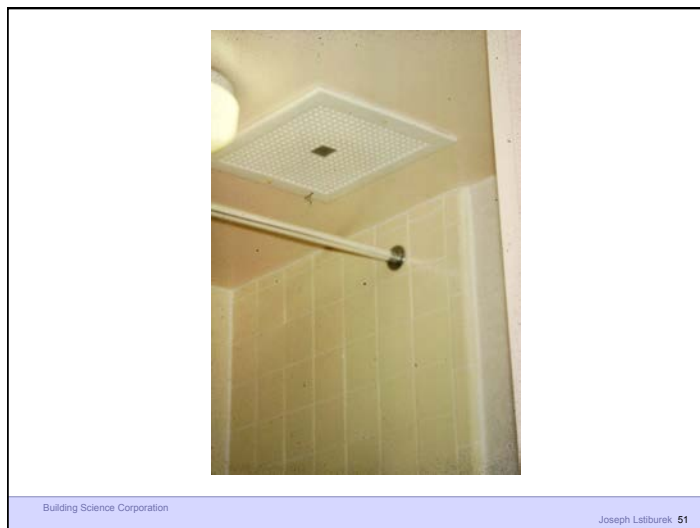

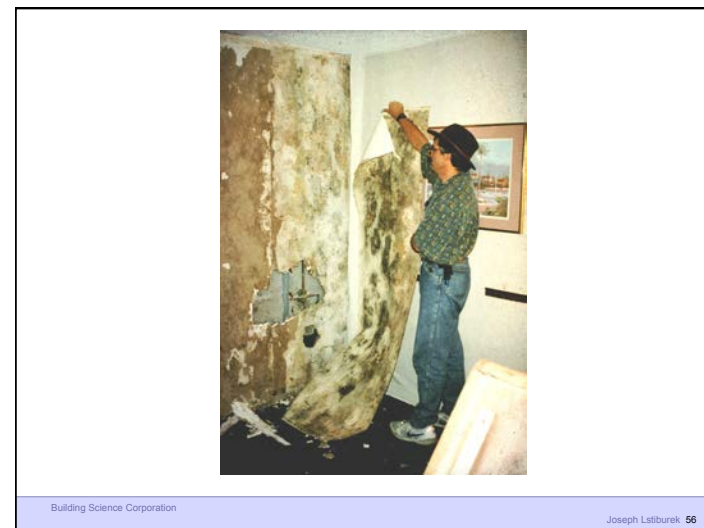
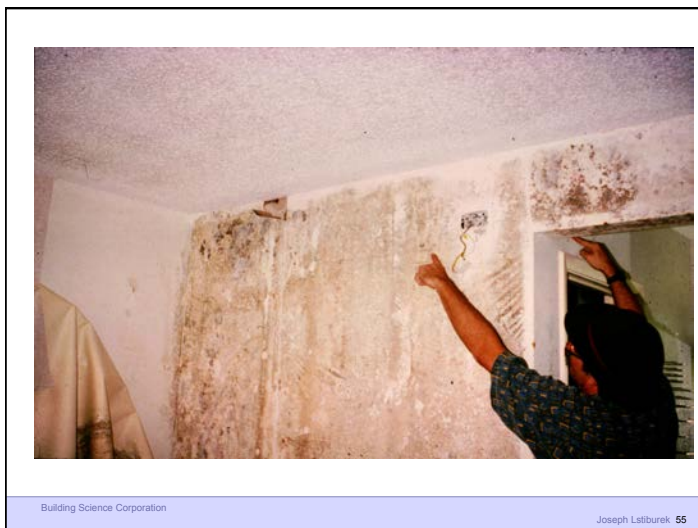



Building Science Corporation

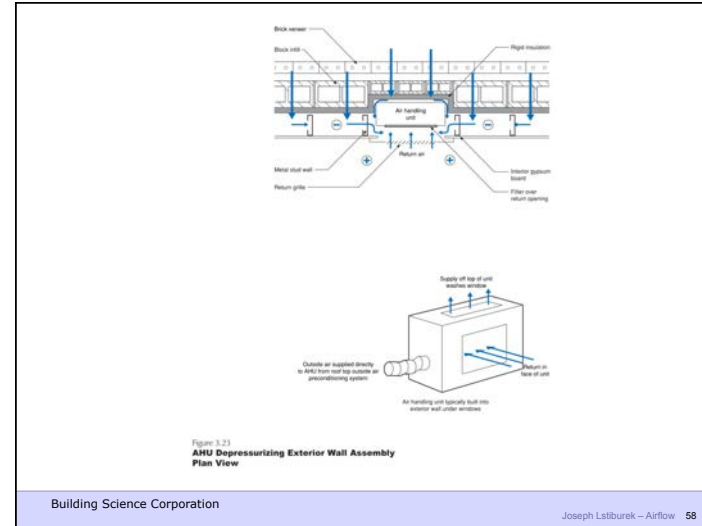

Building Science Corporation

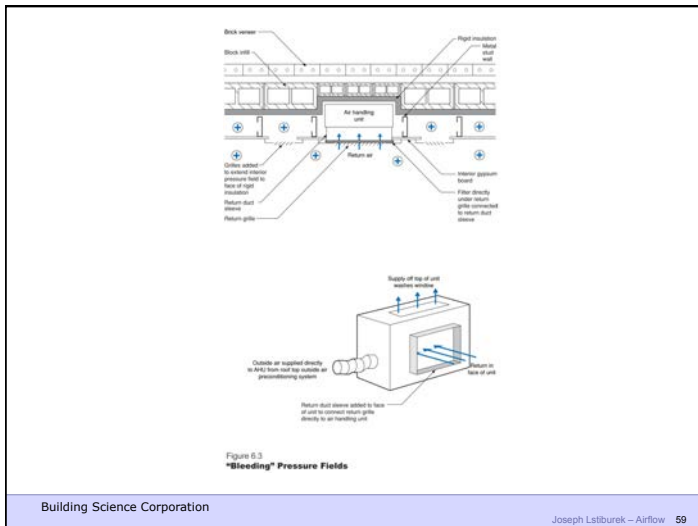

Building Science Corporation

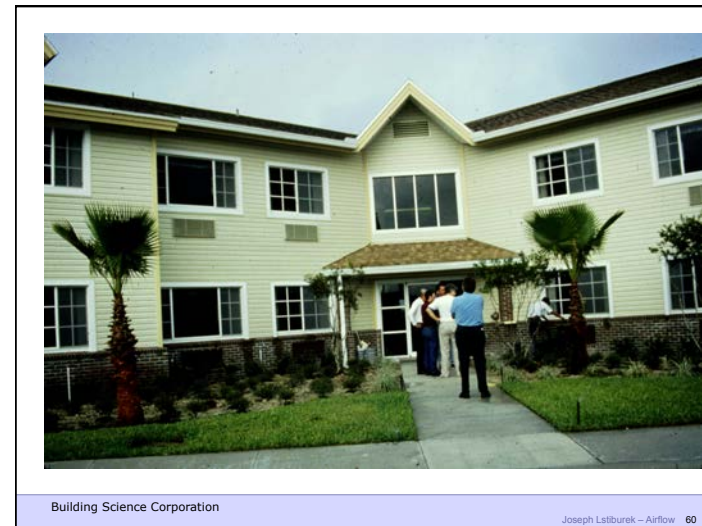

Building Science Corporation



Duct Leakage Should Be Less Than 5% of Rated Flow As Tested by Pressurization To 25 Pascals

Building Science Corporation

Joseph Lstiburek 63



