

Joseph Lstiburek, Ph.D., P.Eng, ASHRAE Fellow

Building Science

Rain Control

www.buildingscience.com



Building Science Corporation

Joseph Lstiburek – Rain Control 2



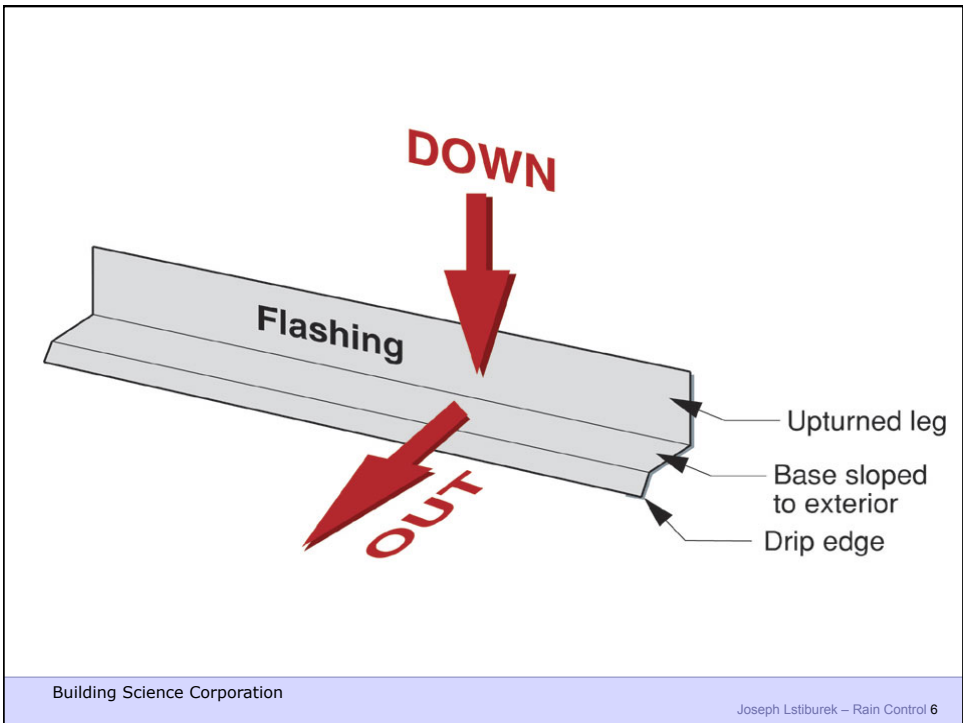

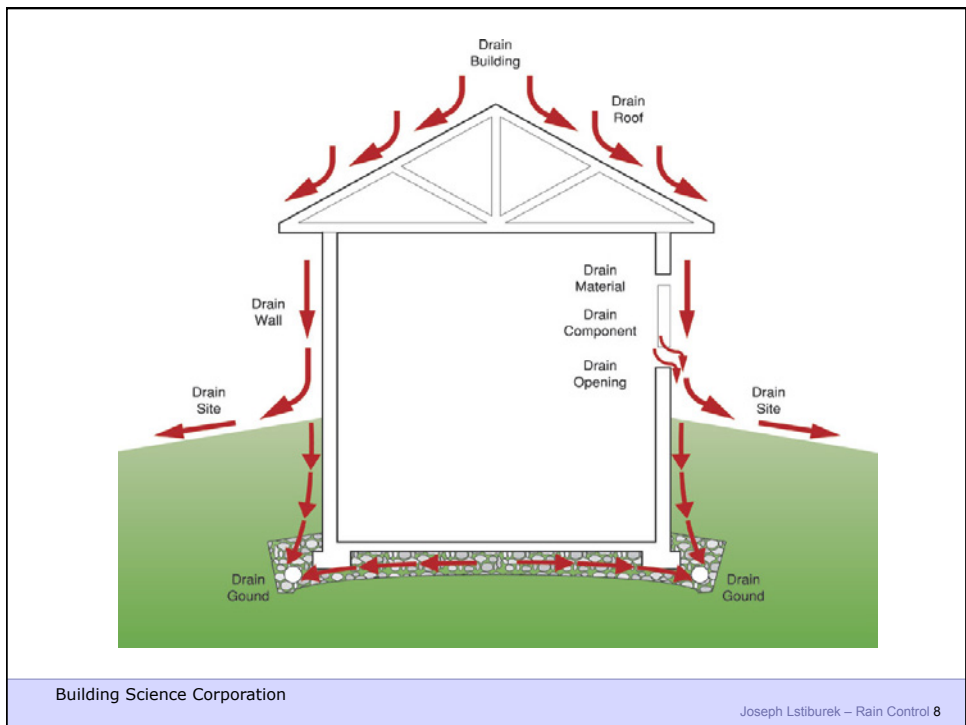
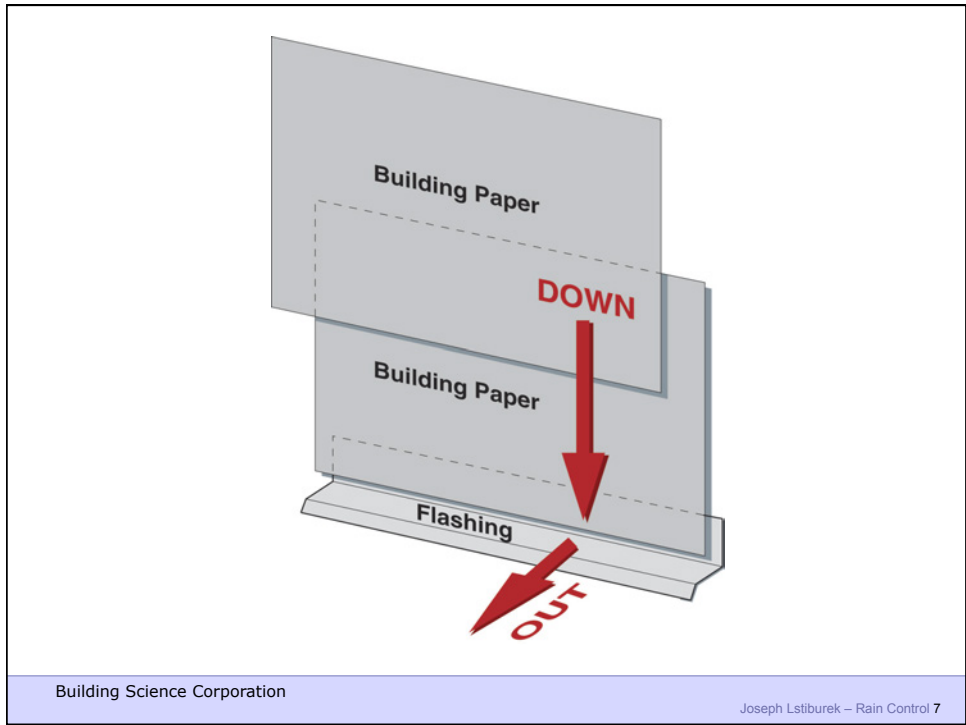

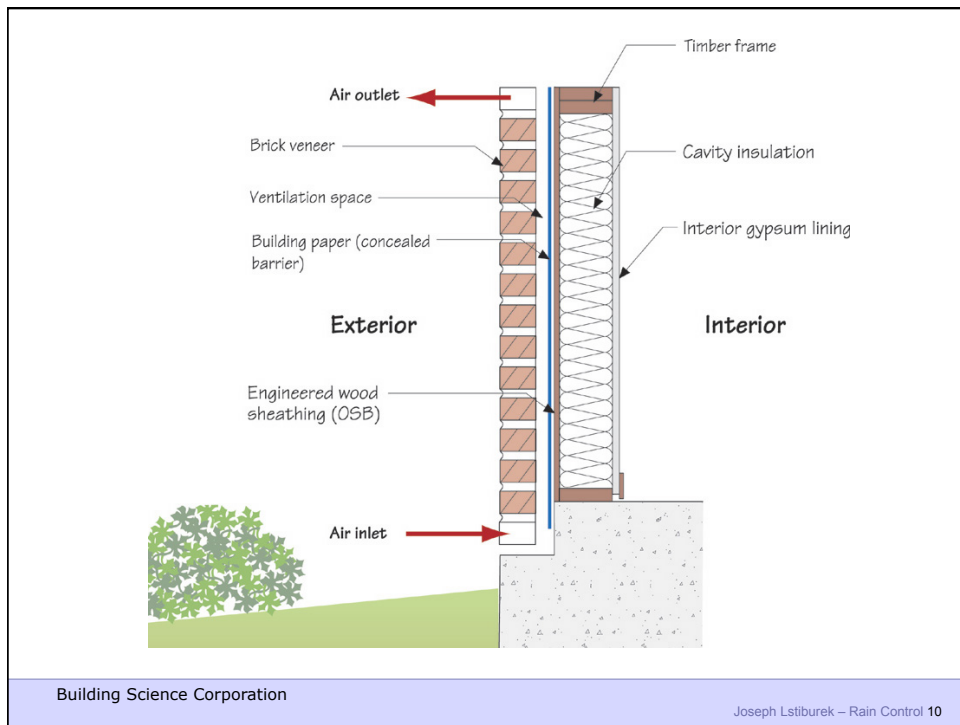
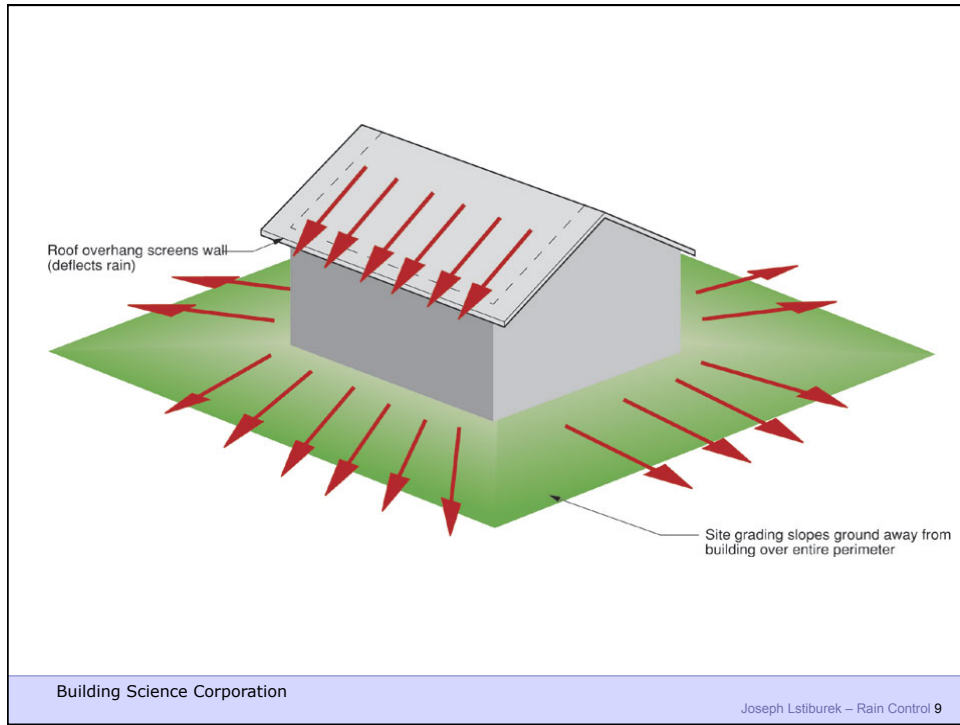

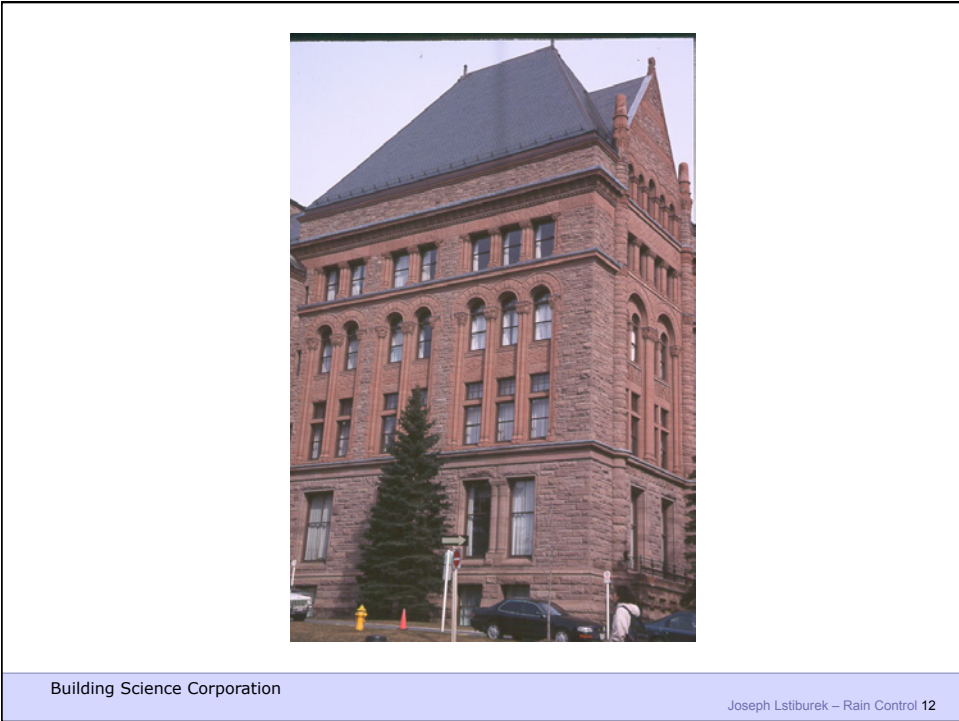

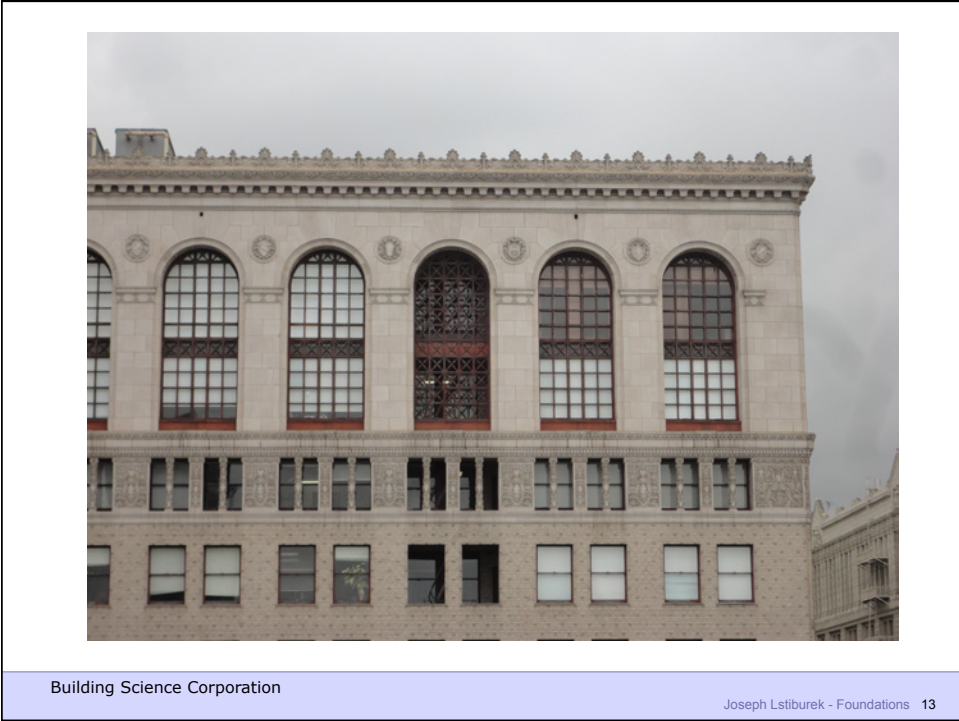

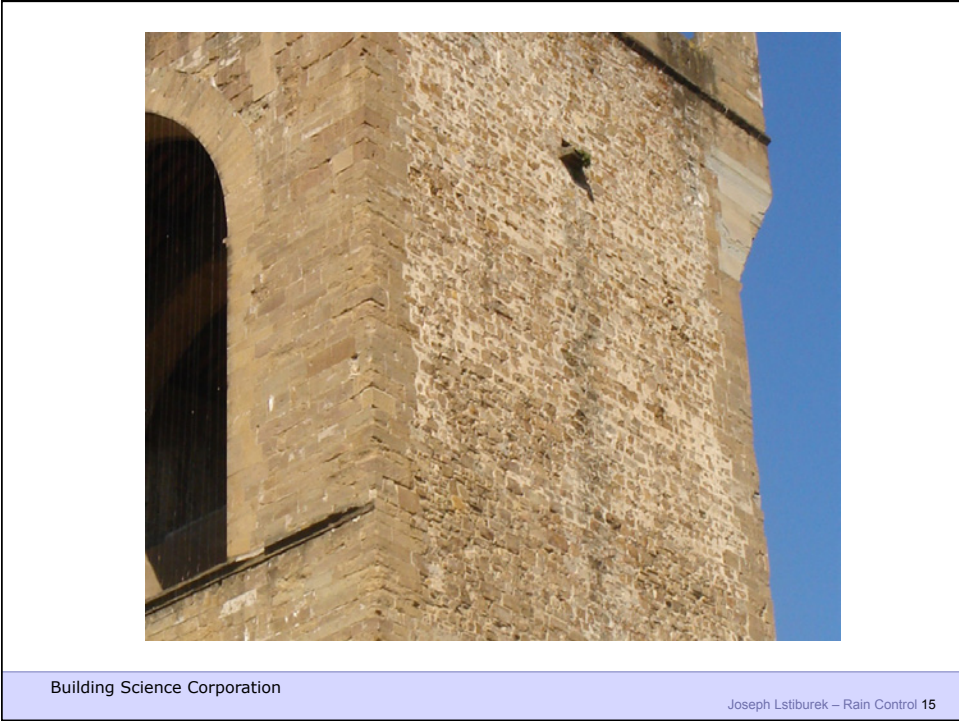

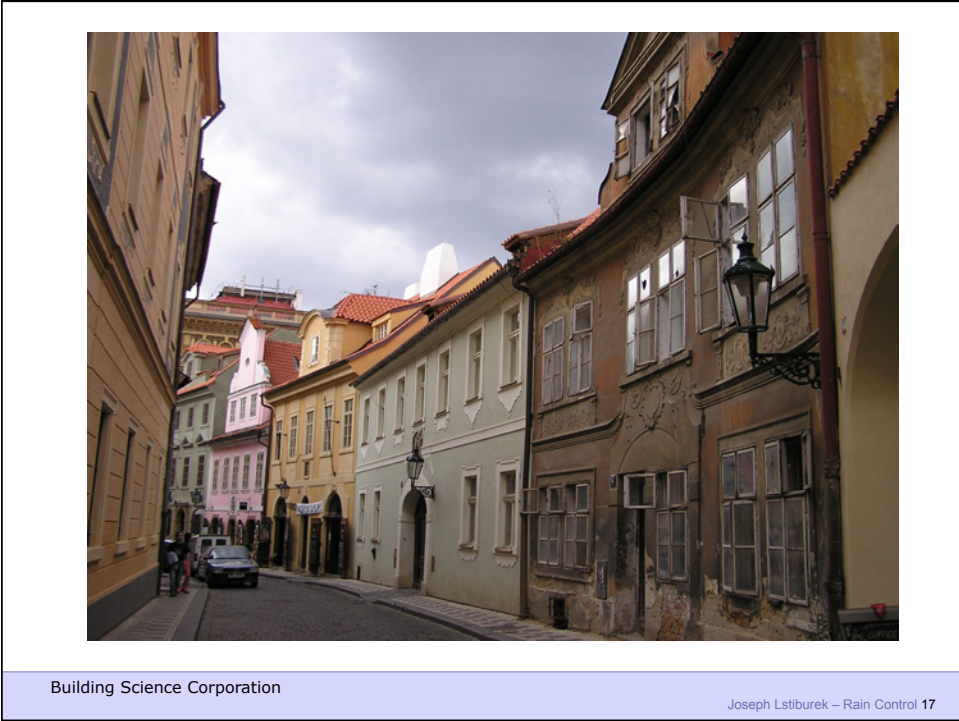

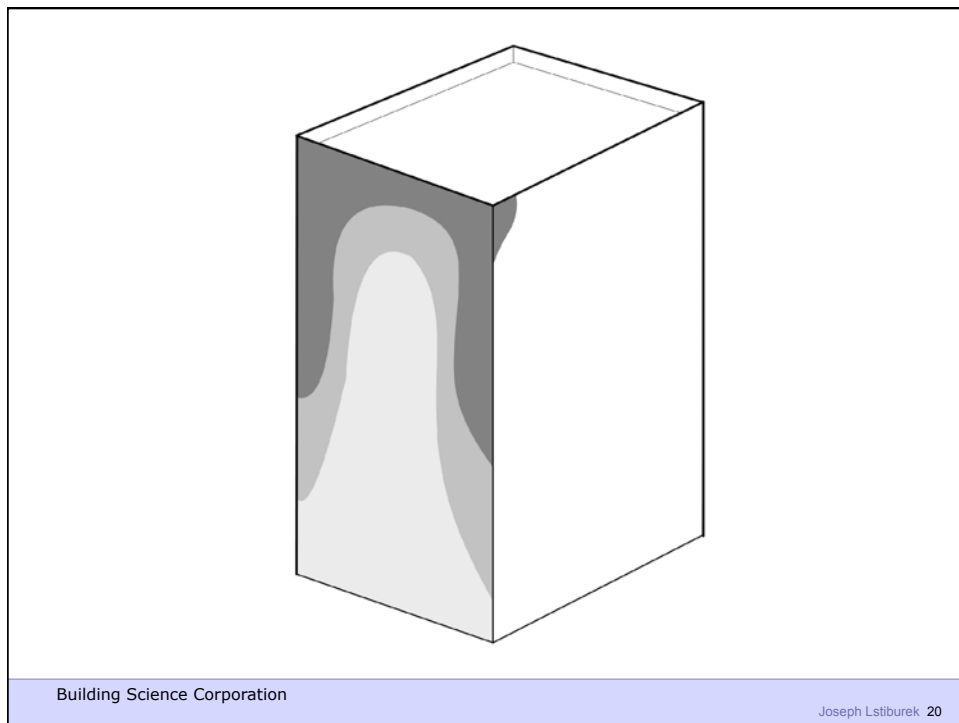
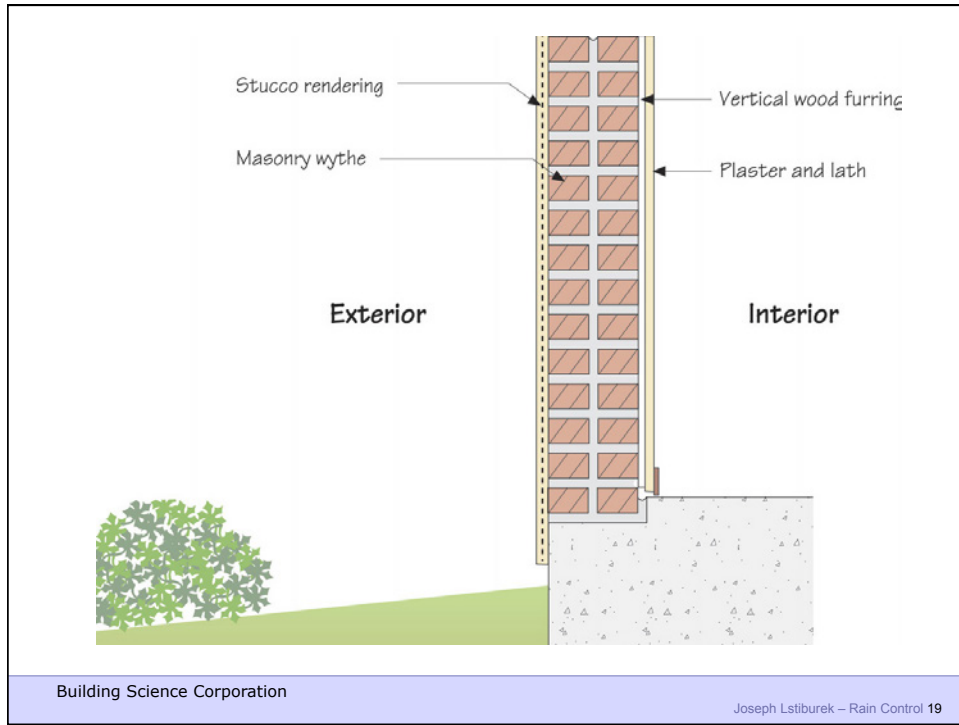

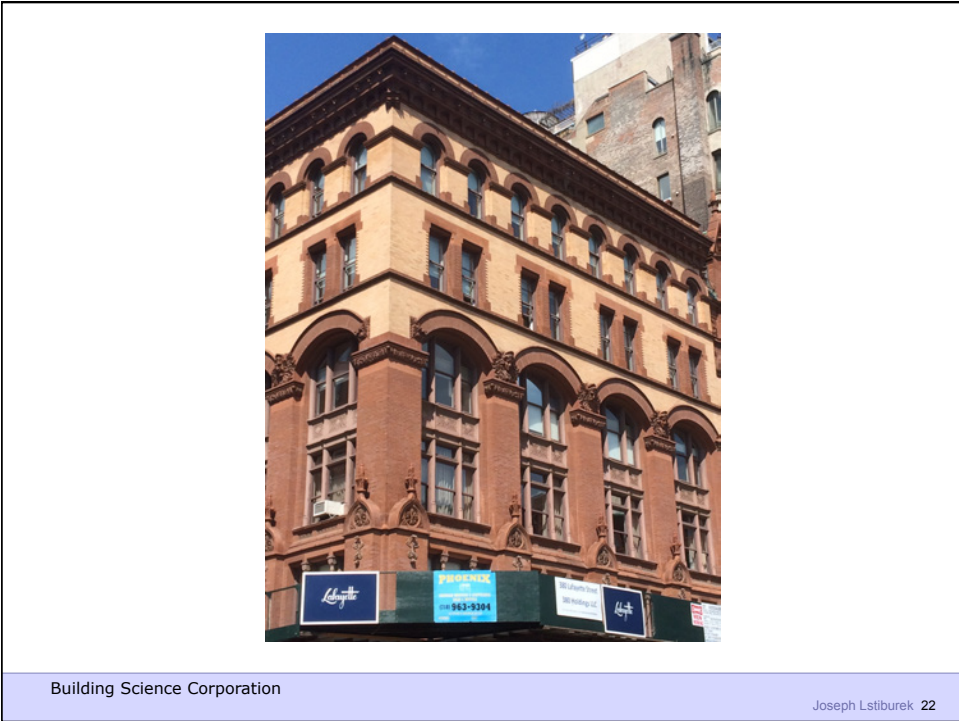

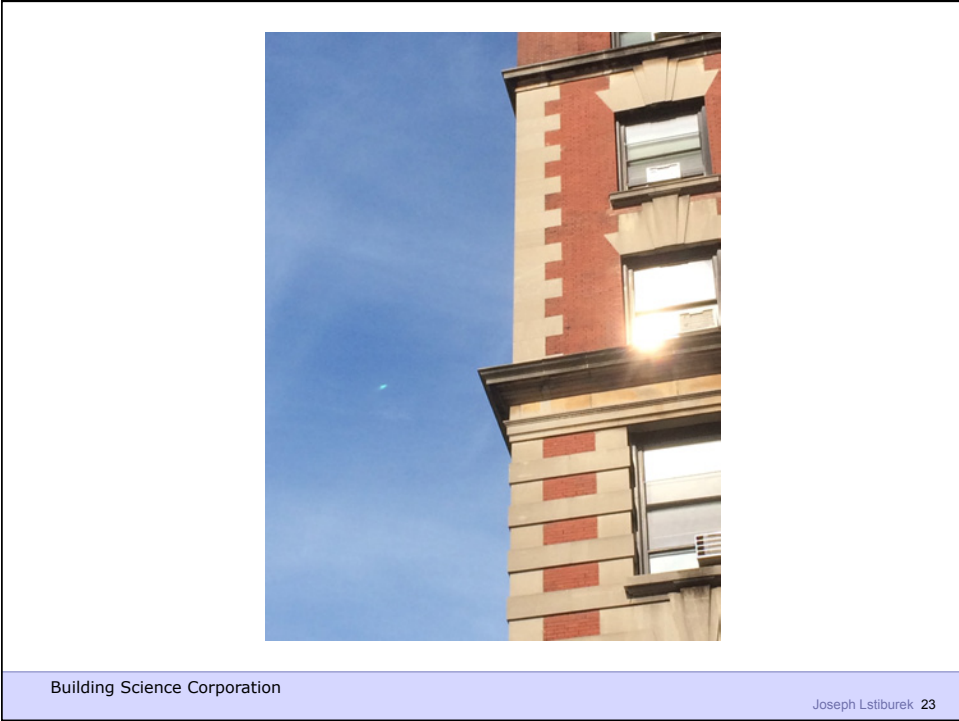

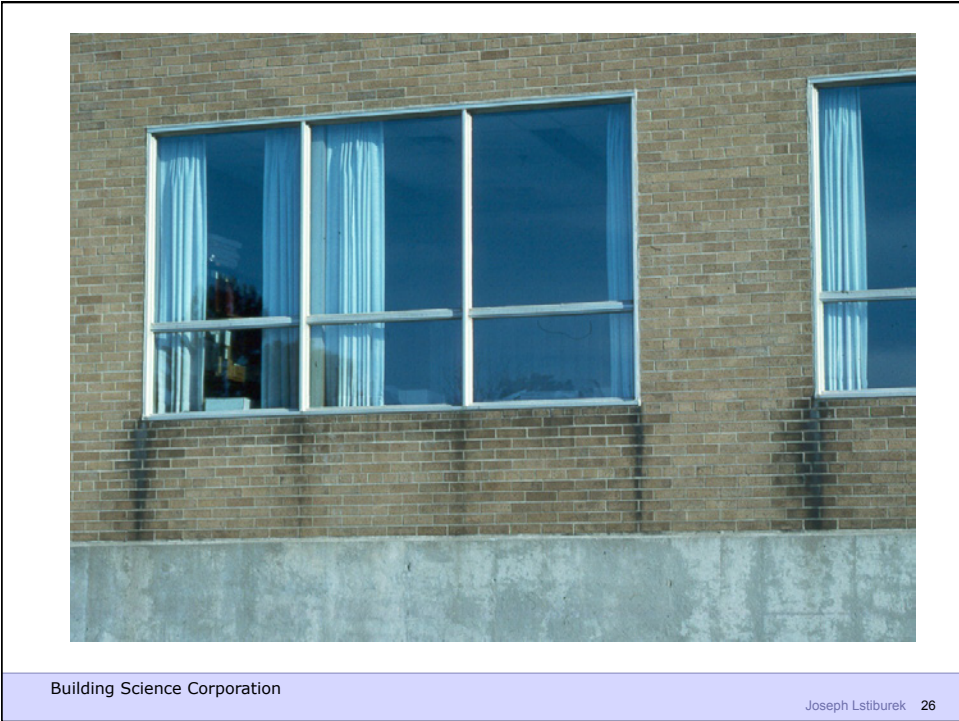
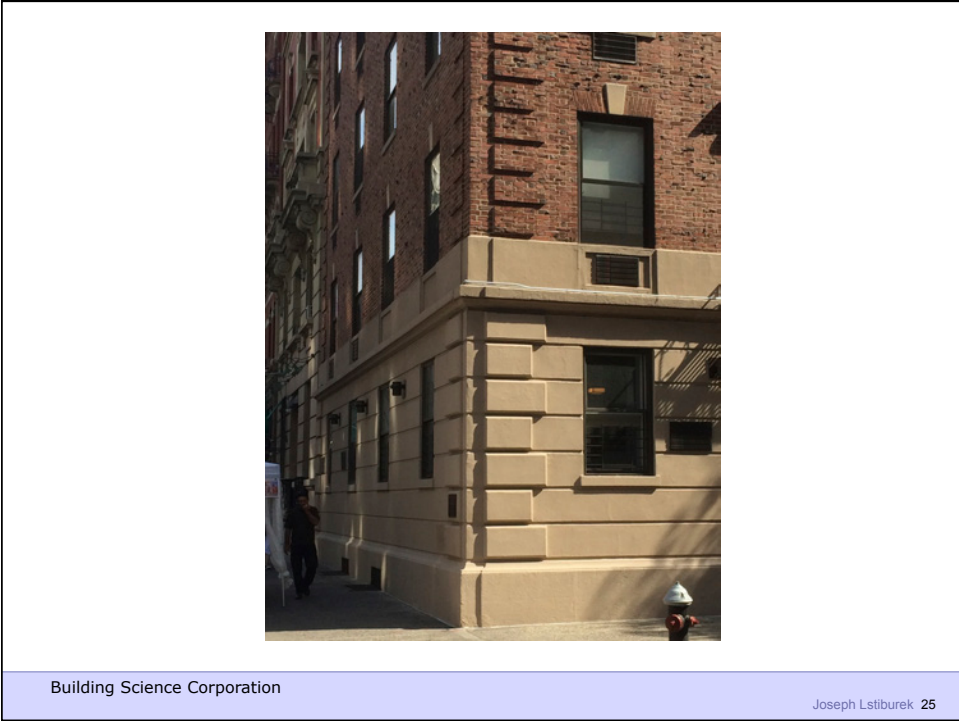

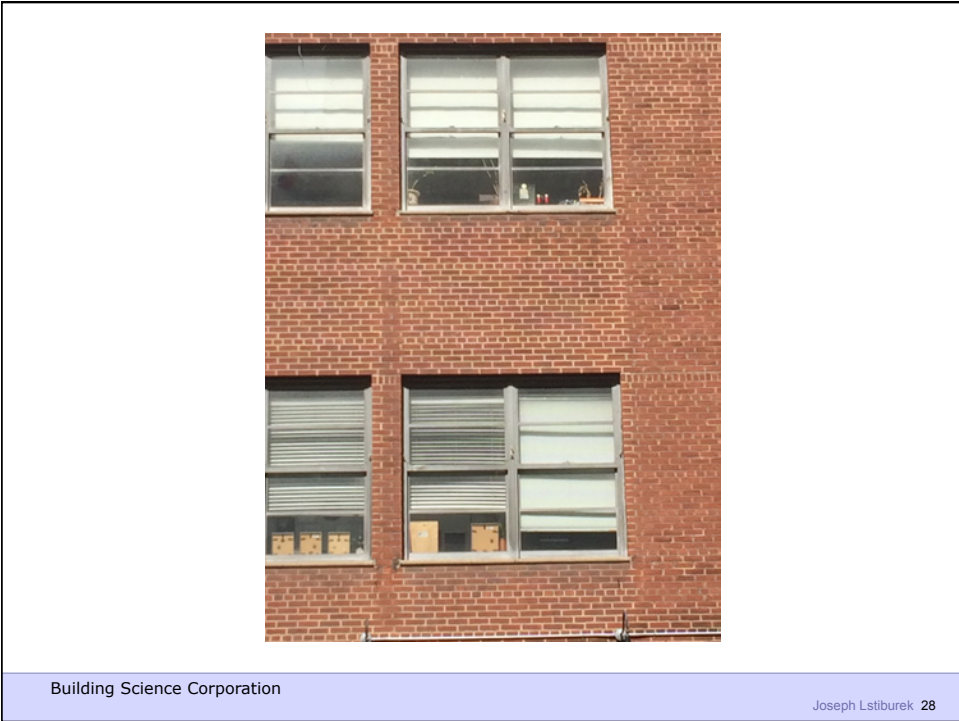
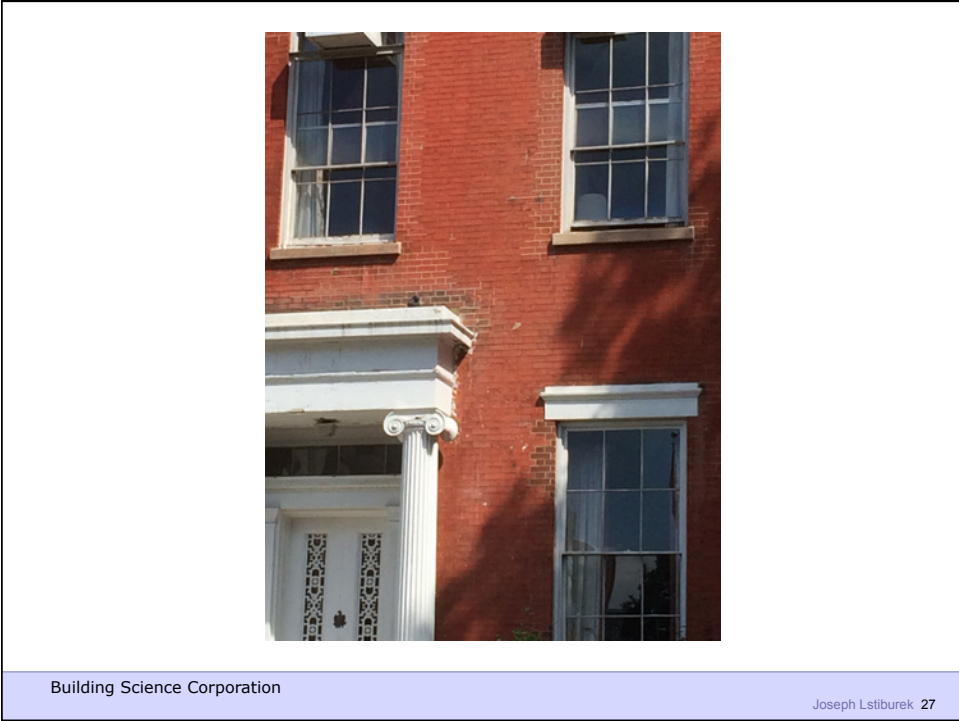

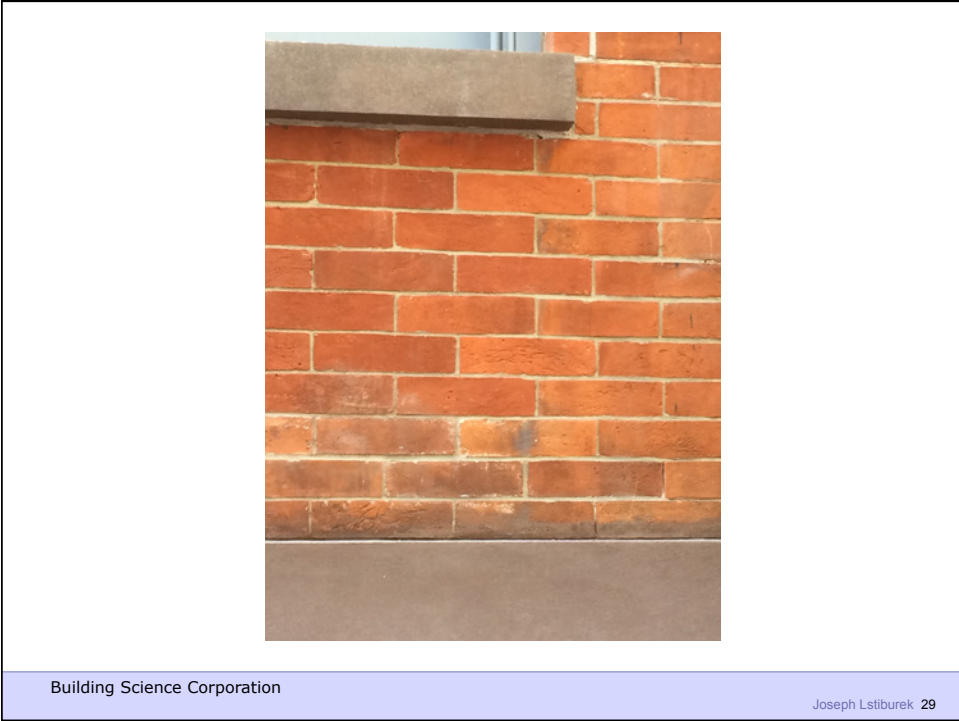





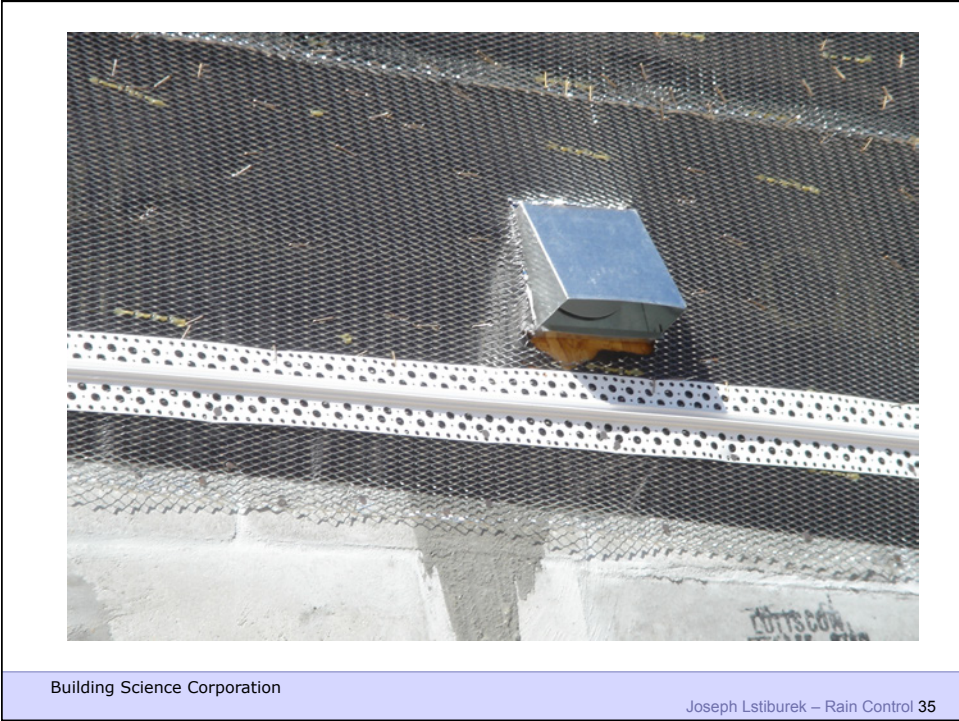

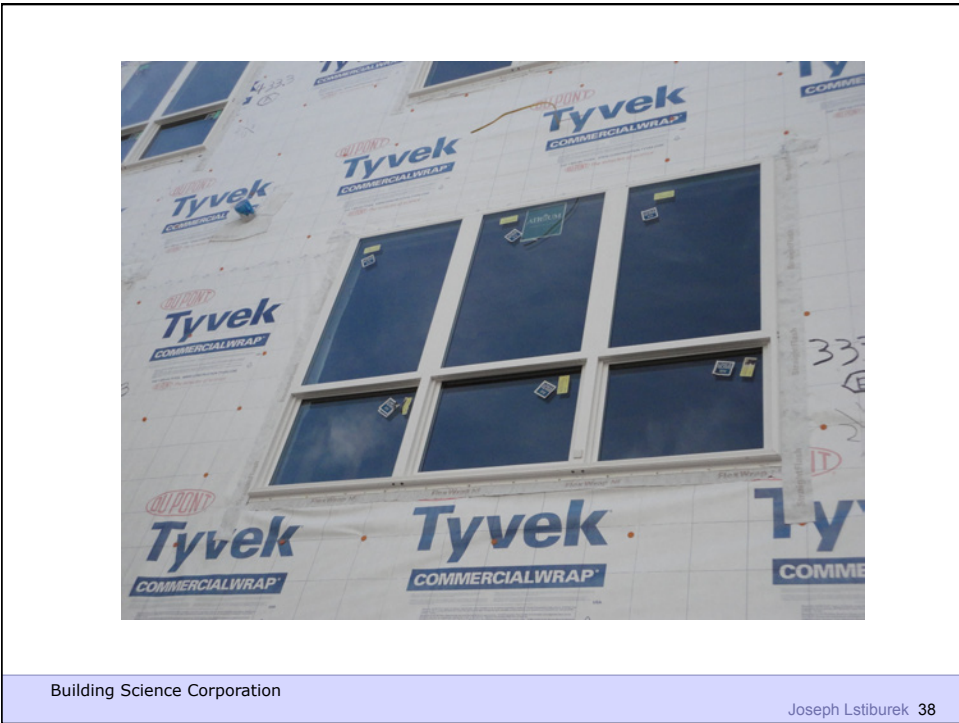
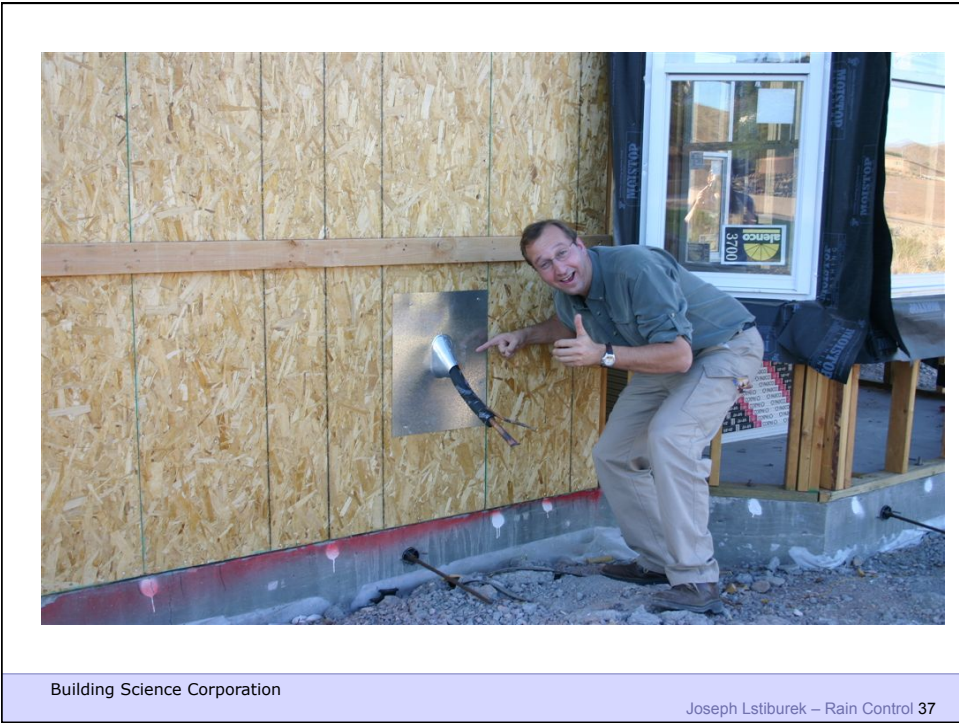

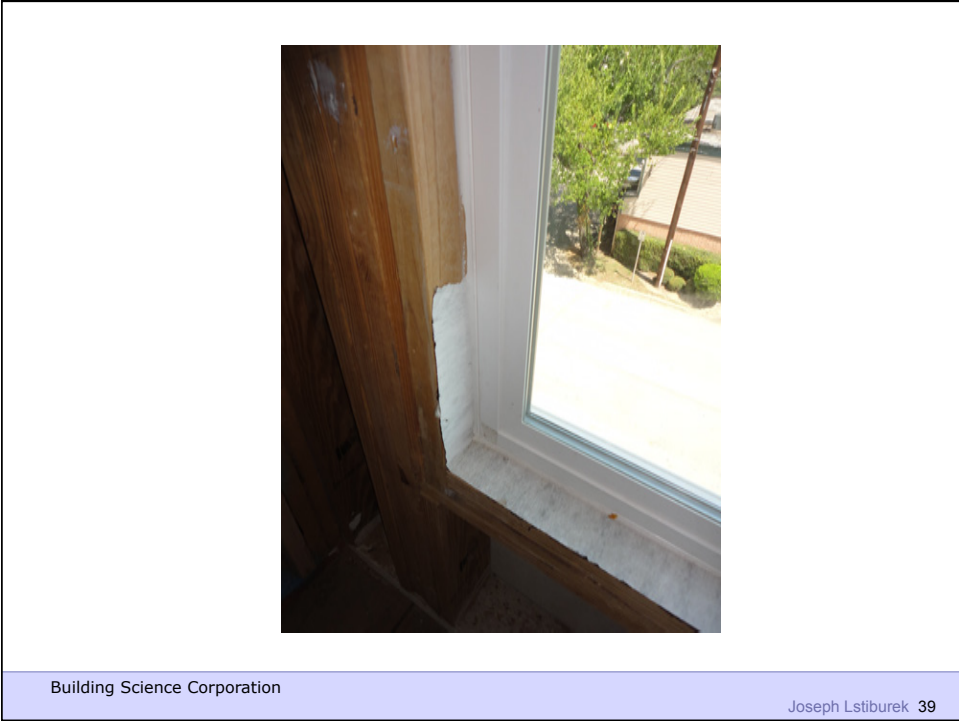



Building Science Corporation

Joseph Lstiburek 41

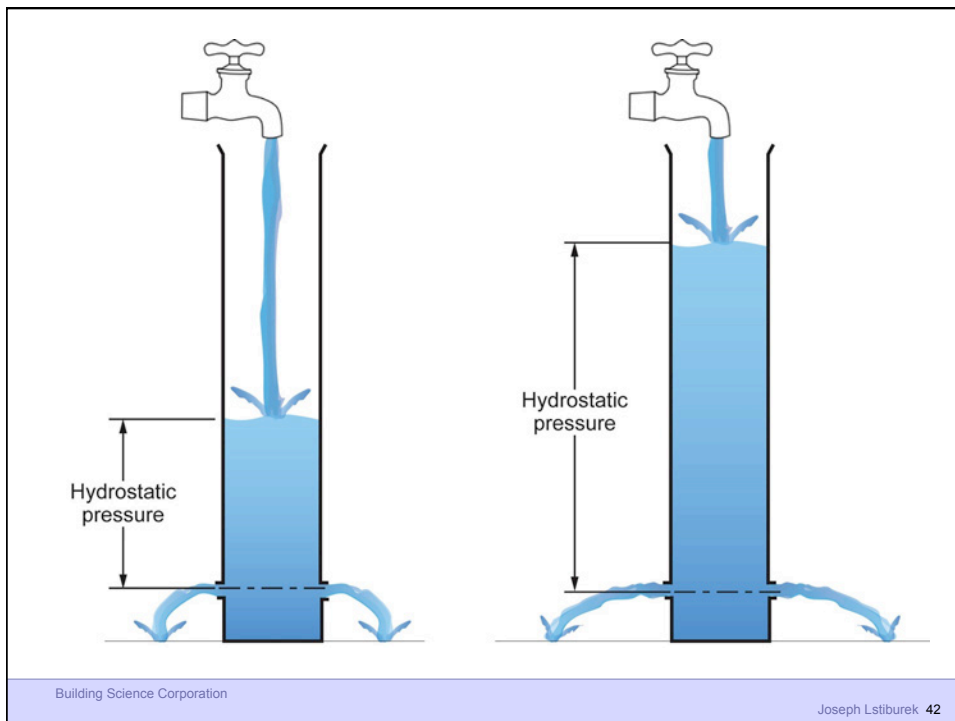

Building Science Corporation

Joseph Lstiburek 42

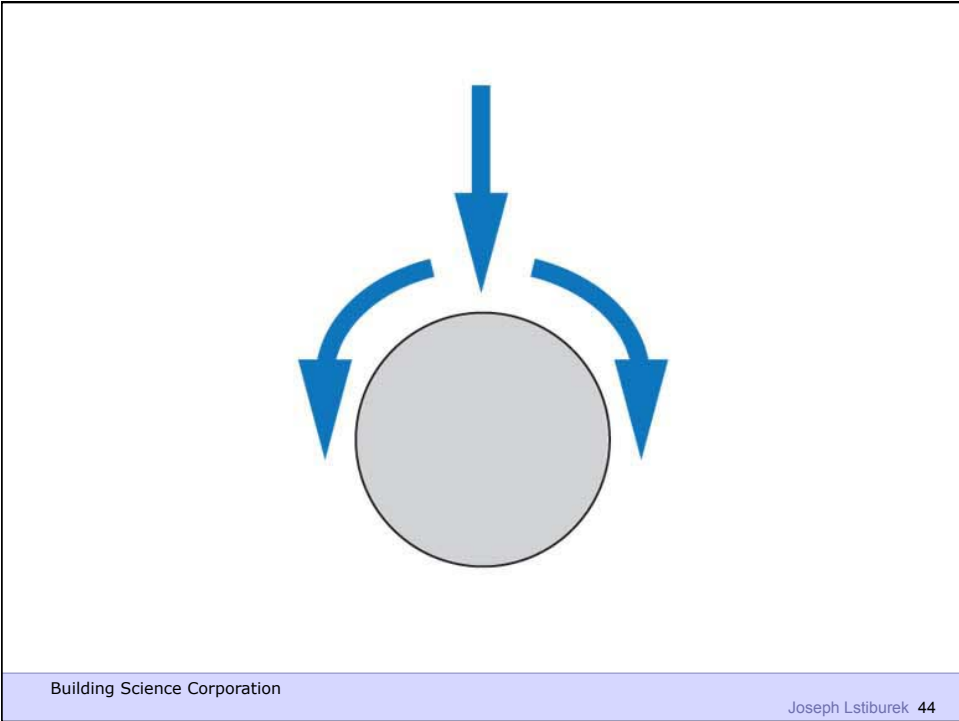
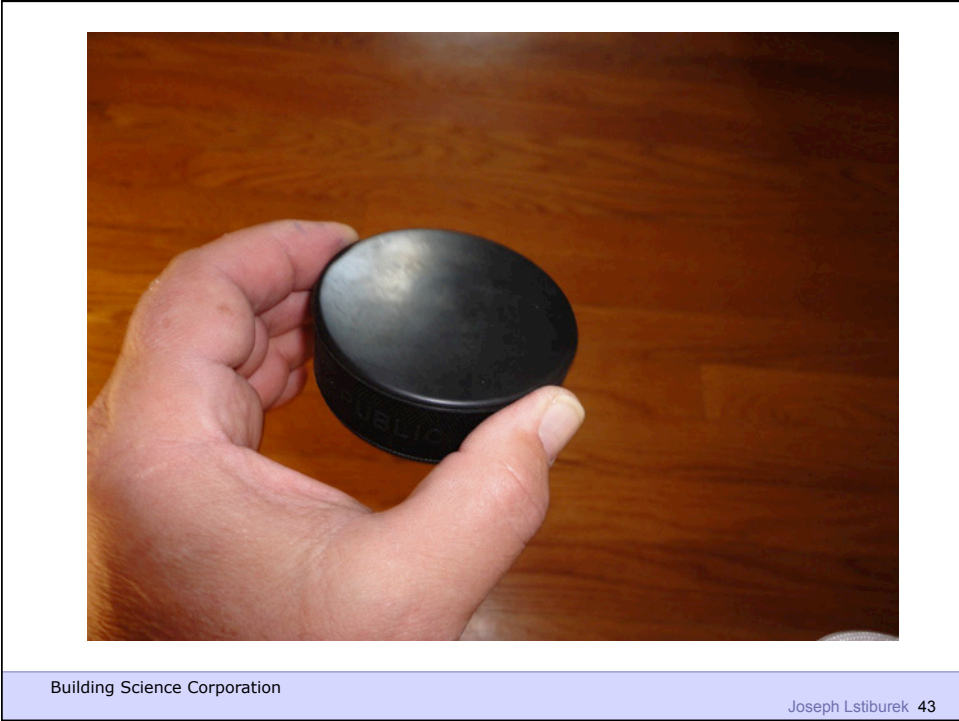

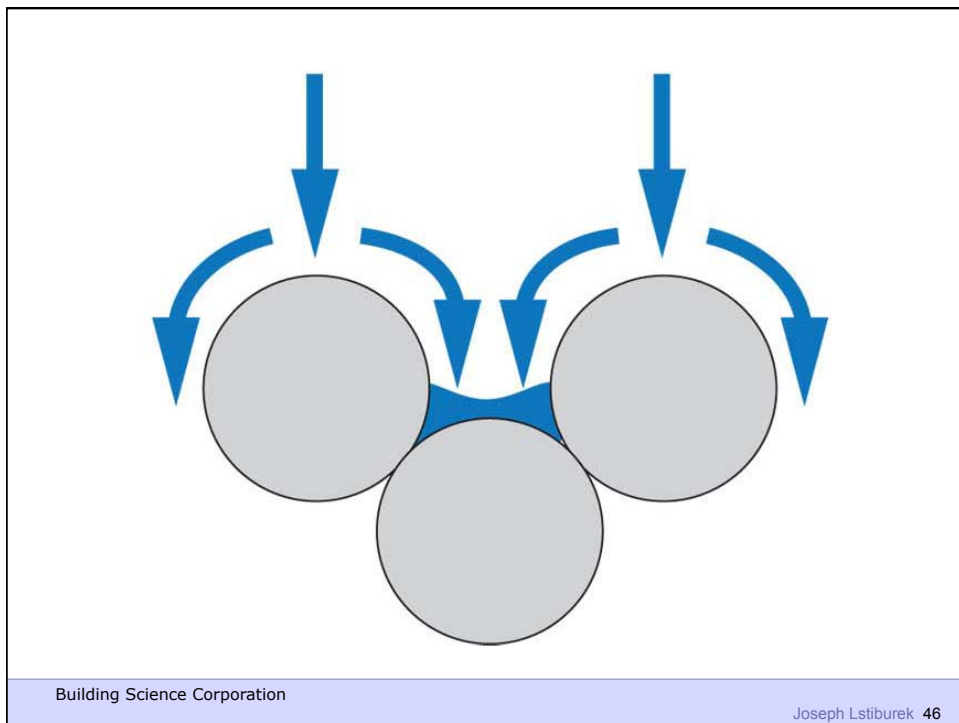
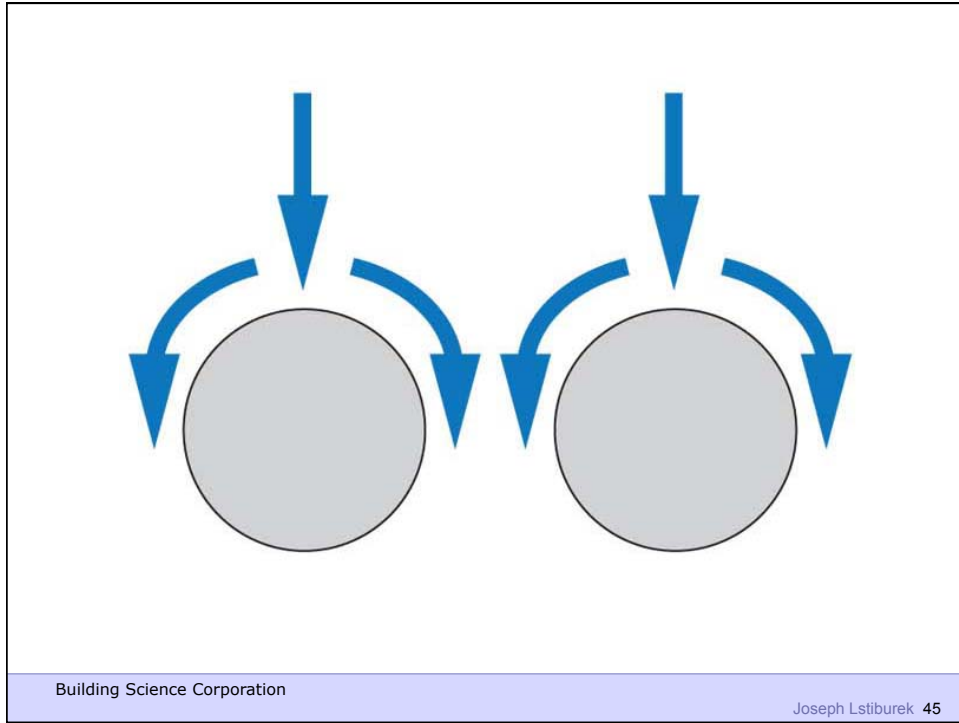



Building Science Corporation

Joseph Lstiburek 47

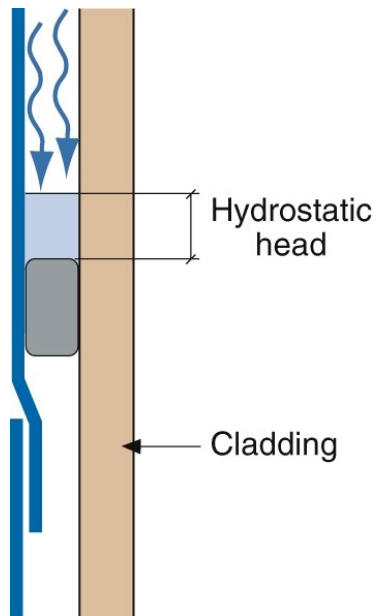

Building Science Corporation

Joseph Lstiburek 48

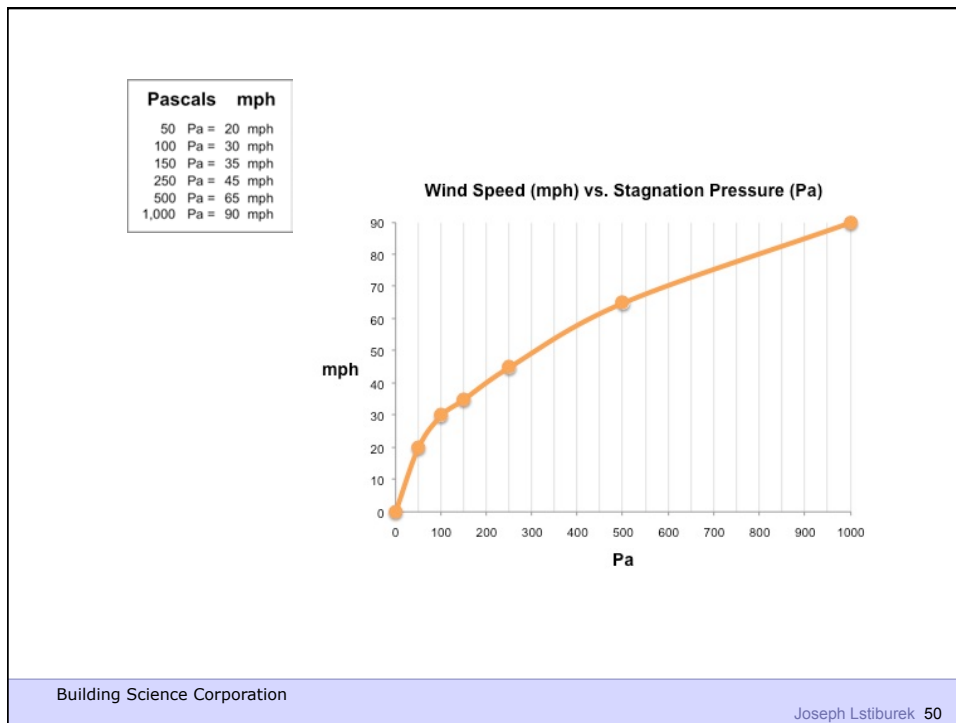
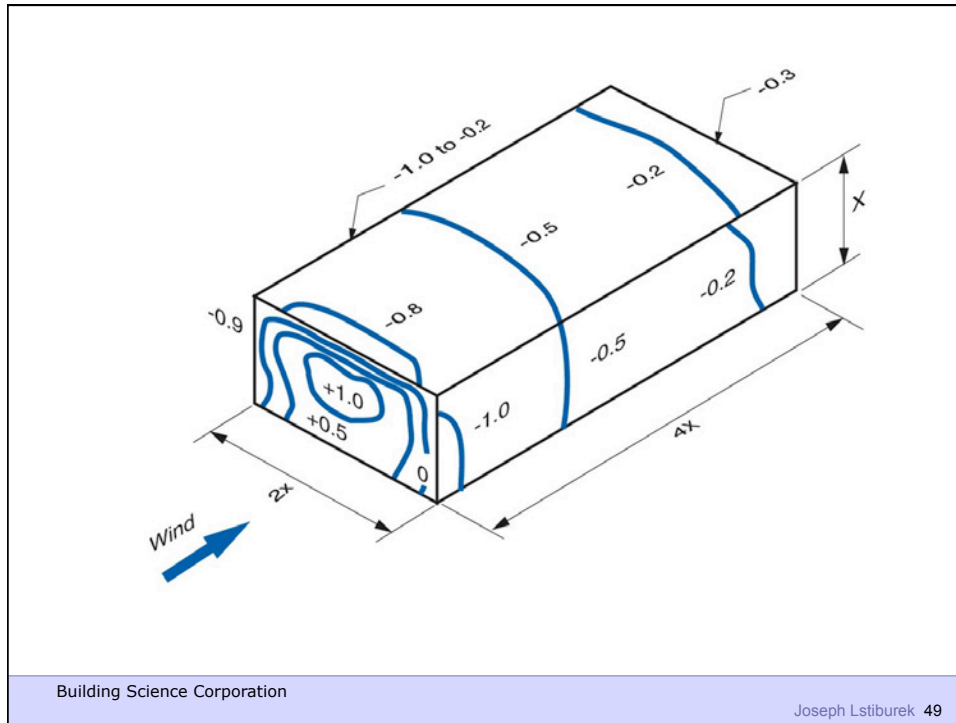



Building Science Corporation

Joseph Lstiburek 51

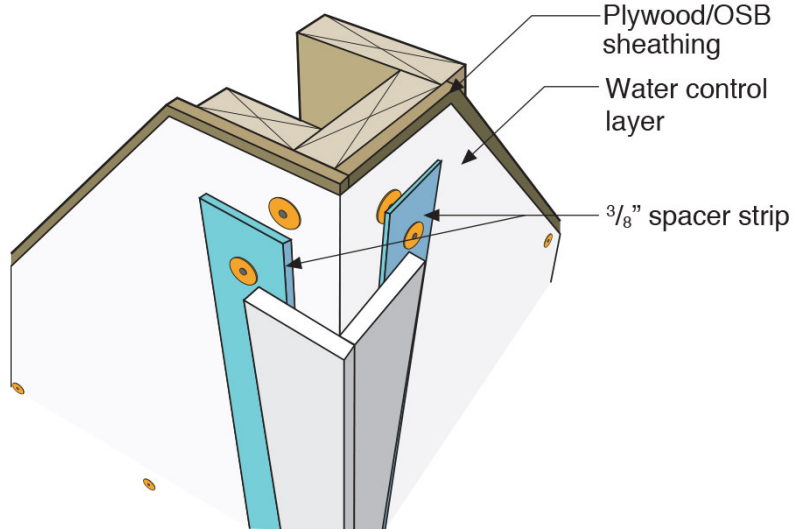

Building Science Corporation

Joseph Lstiburek 52



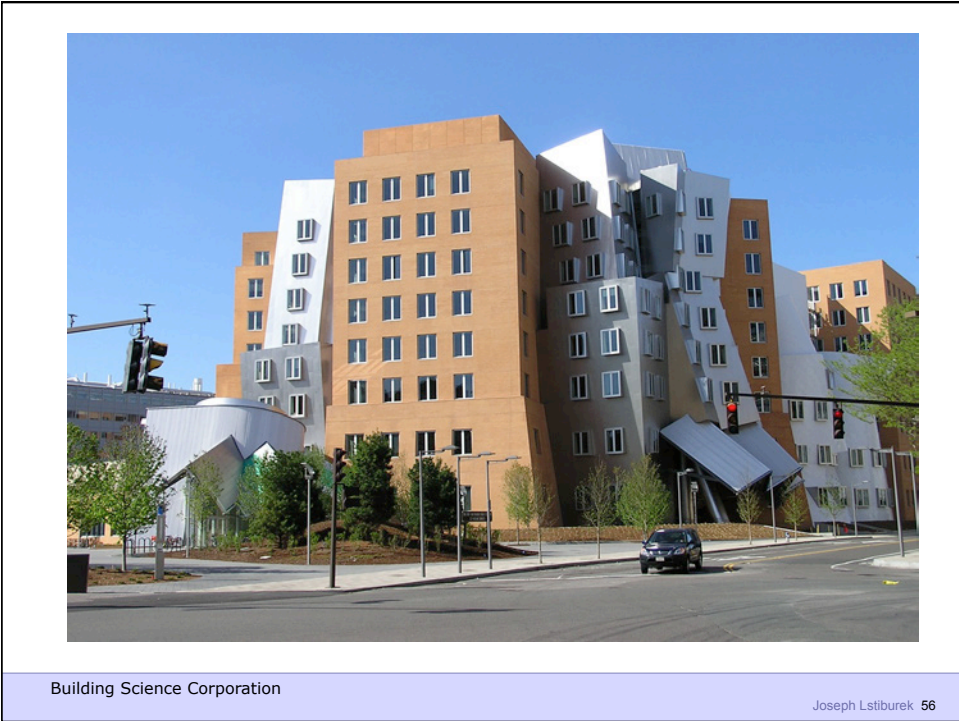

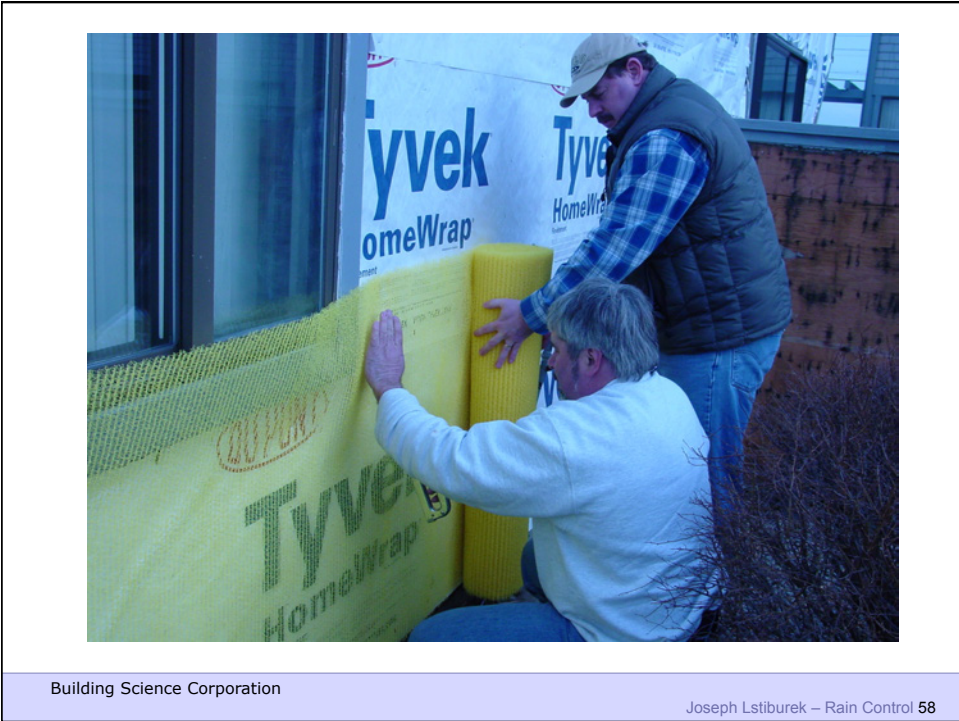
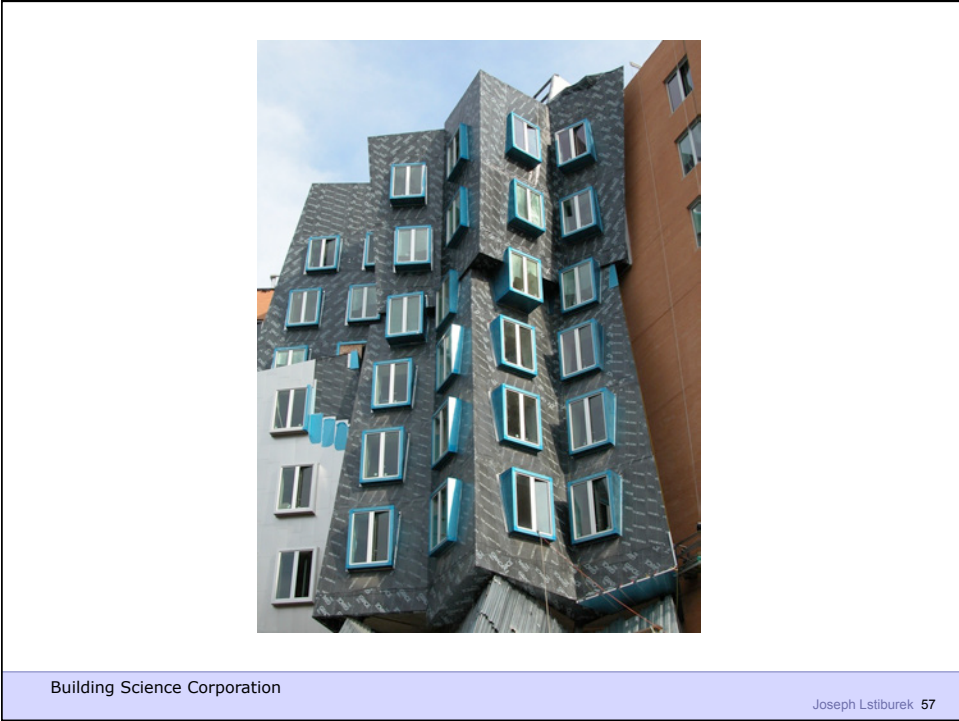



Building Science Corporation

Joseph Lstiburek – Rain Control 59

Rain enters cup
due to momentum
("kinetic energy")

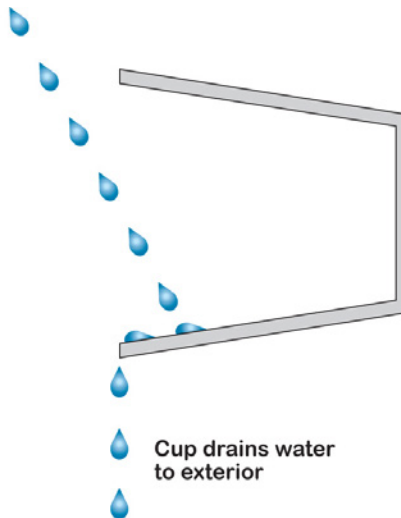

Cup drains water
to exterior

Building Science Corporation
2011

Joseph Lstiburek 60

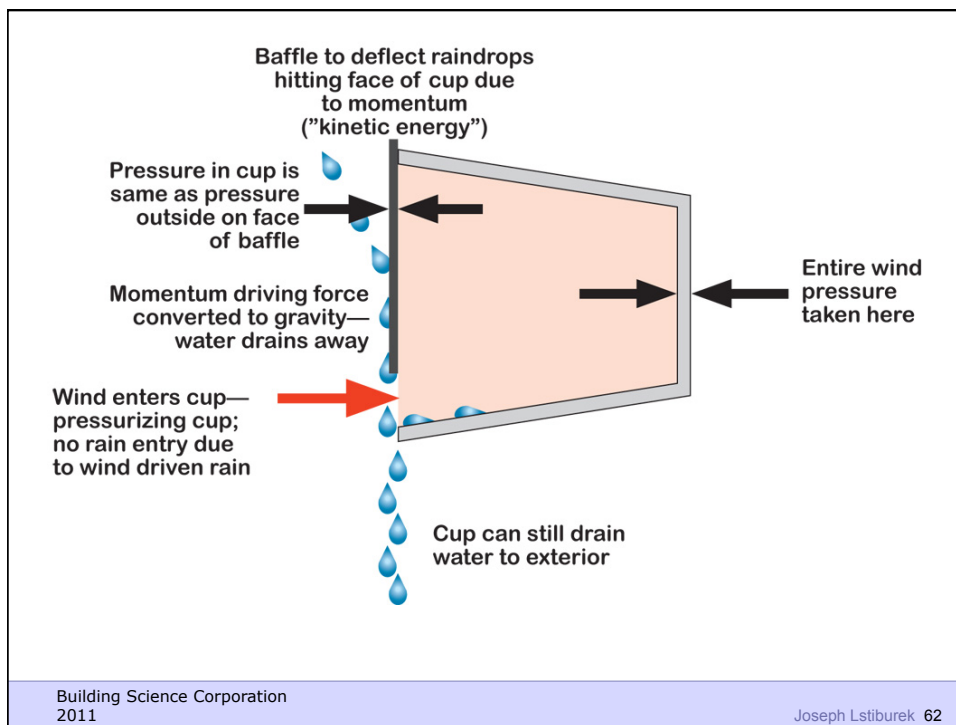
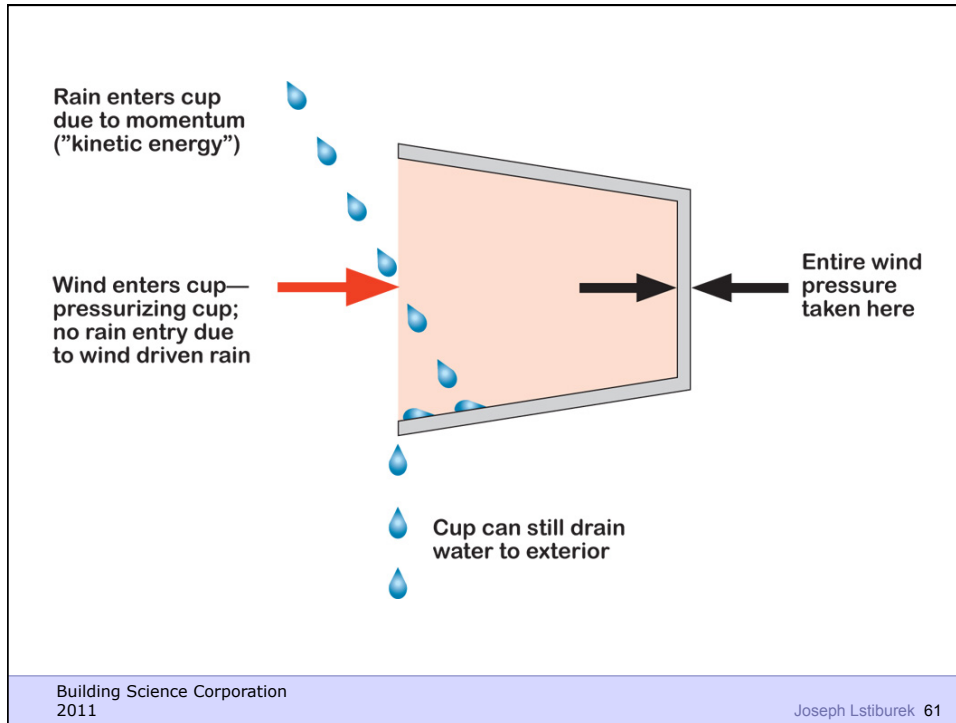

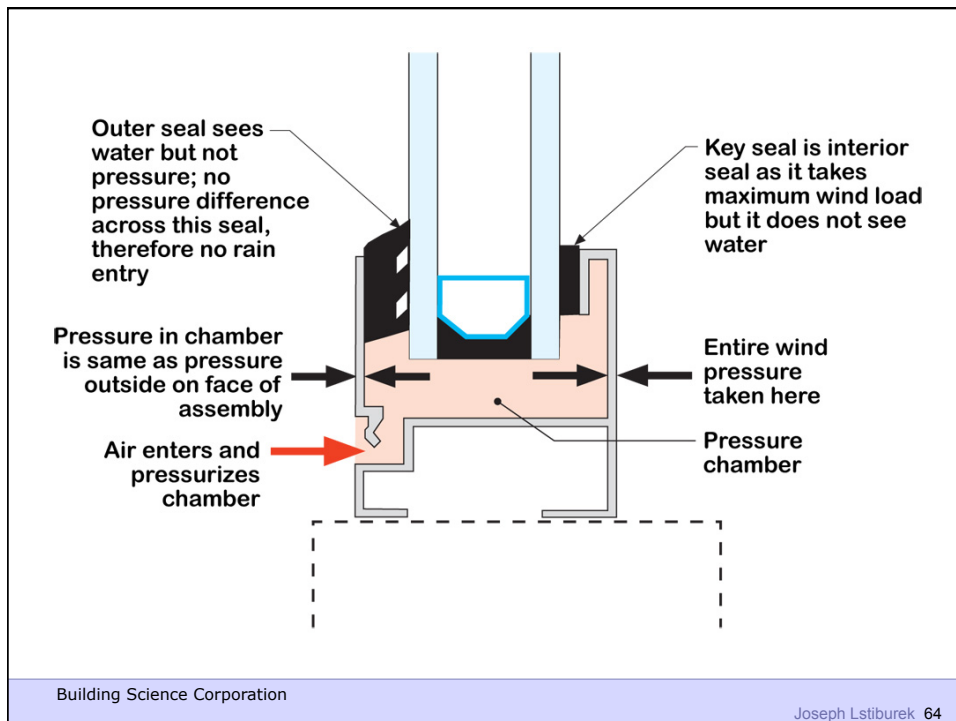
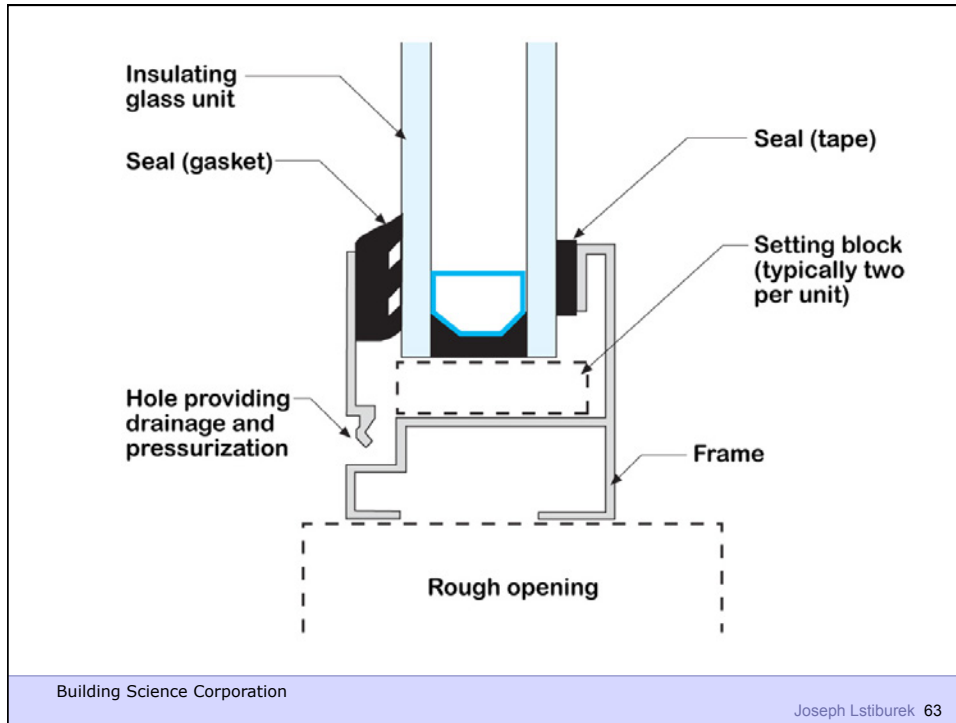

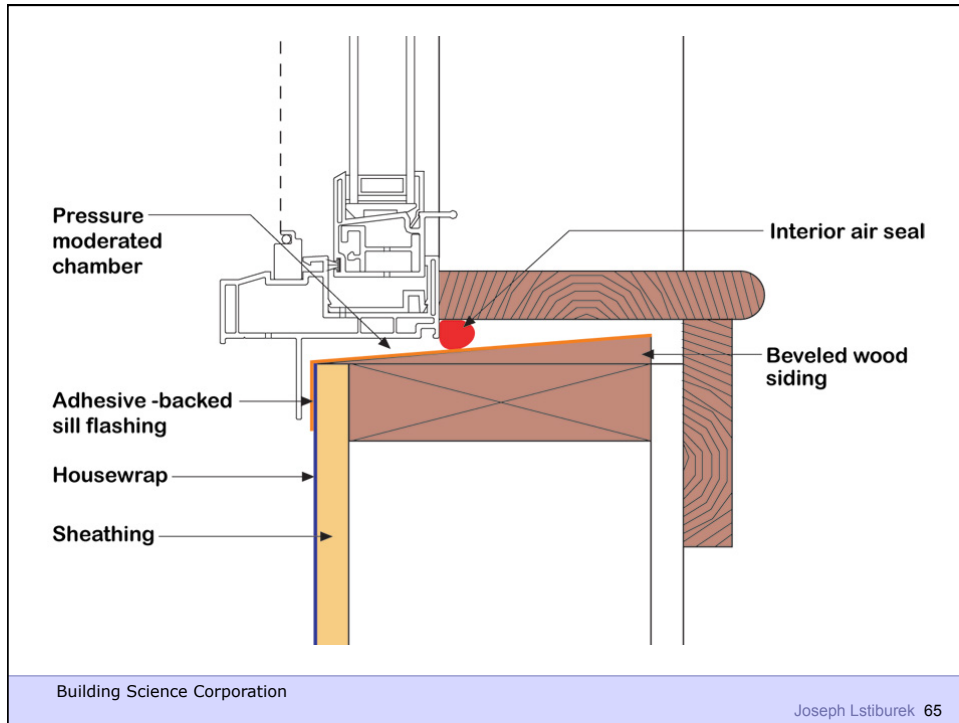



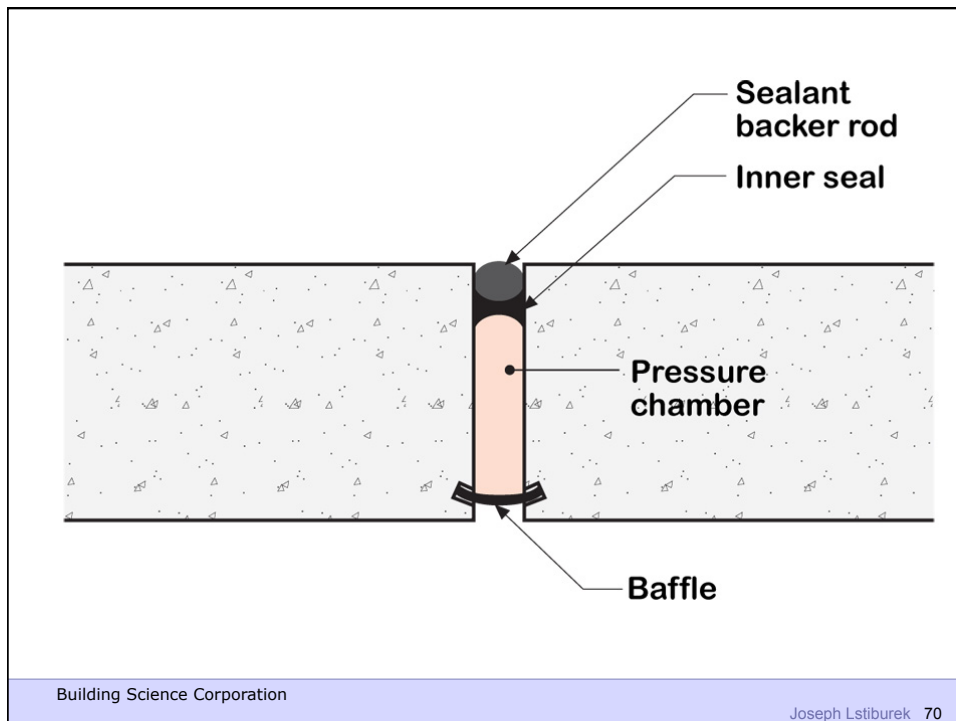
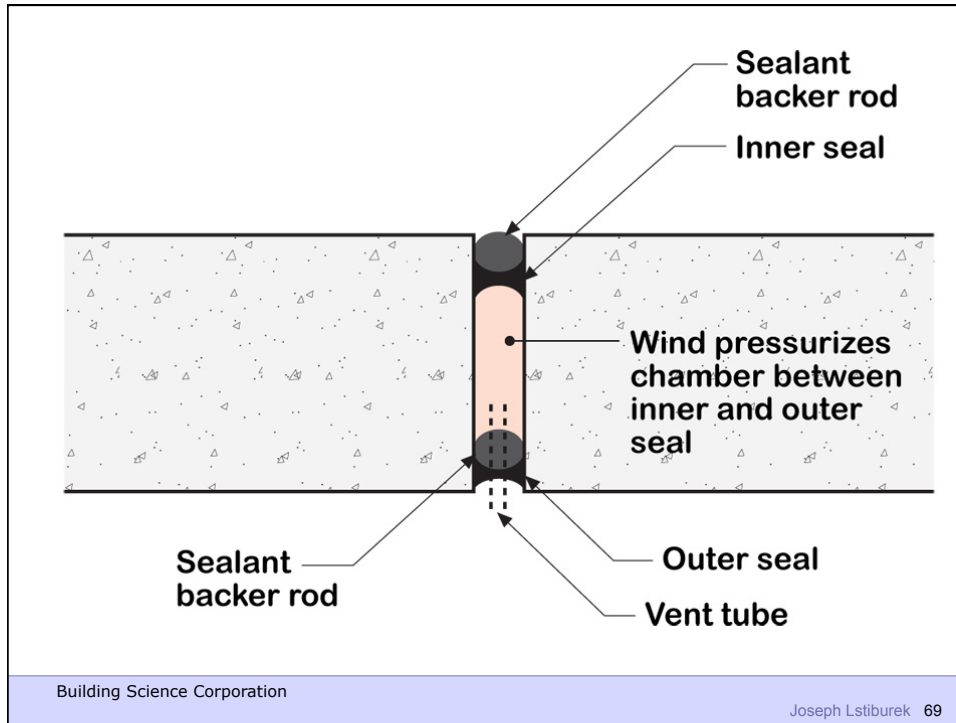

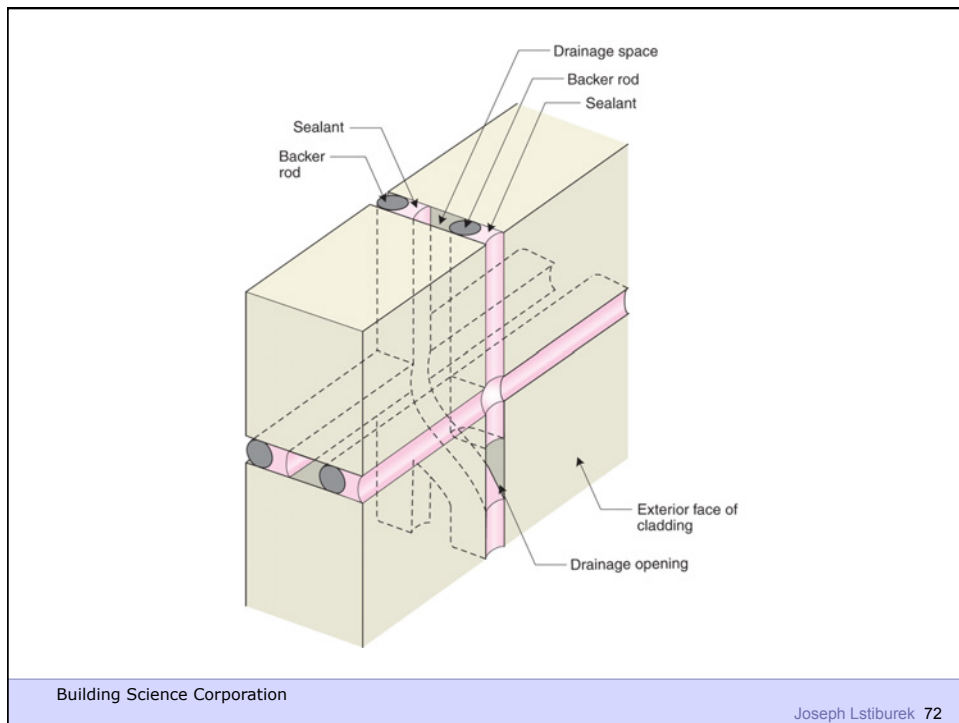
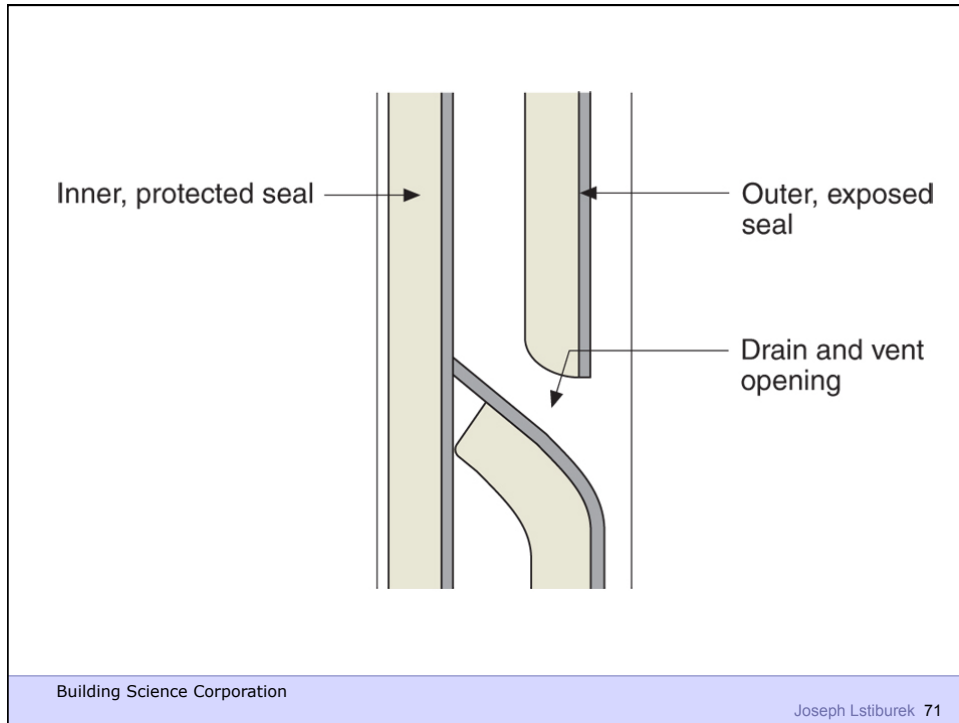









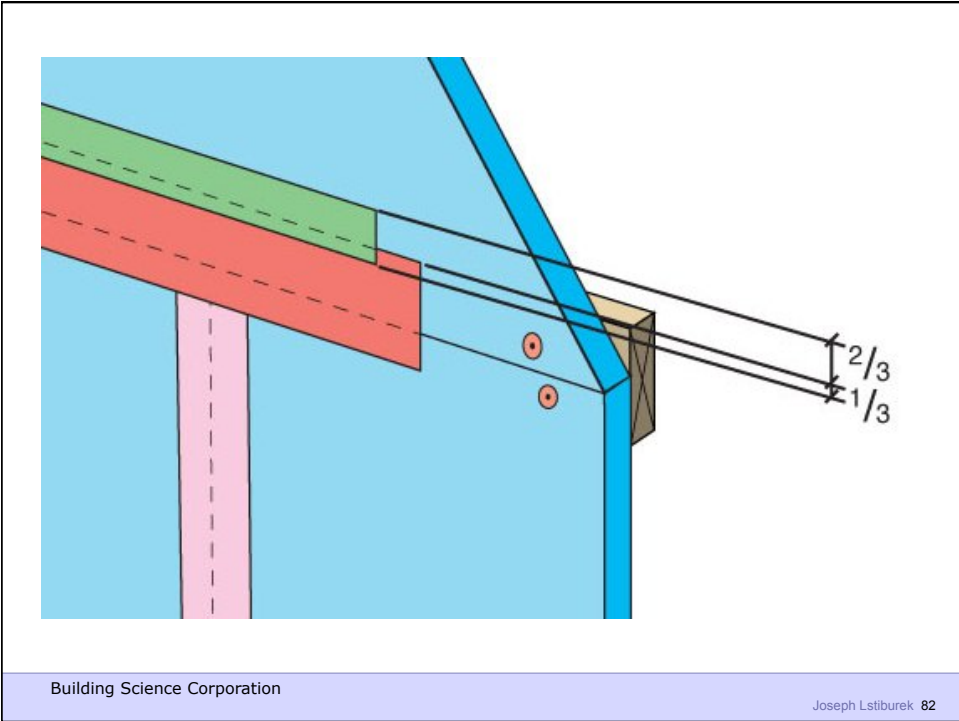
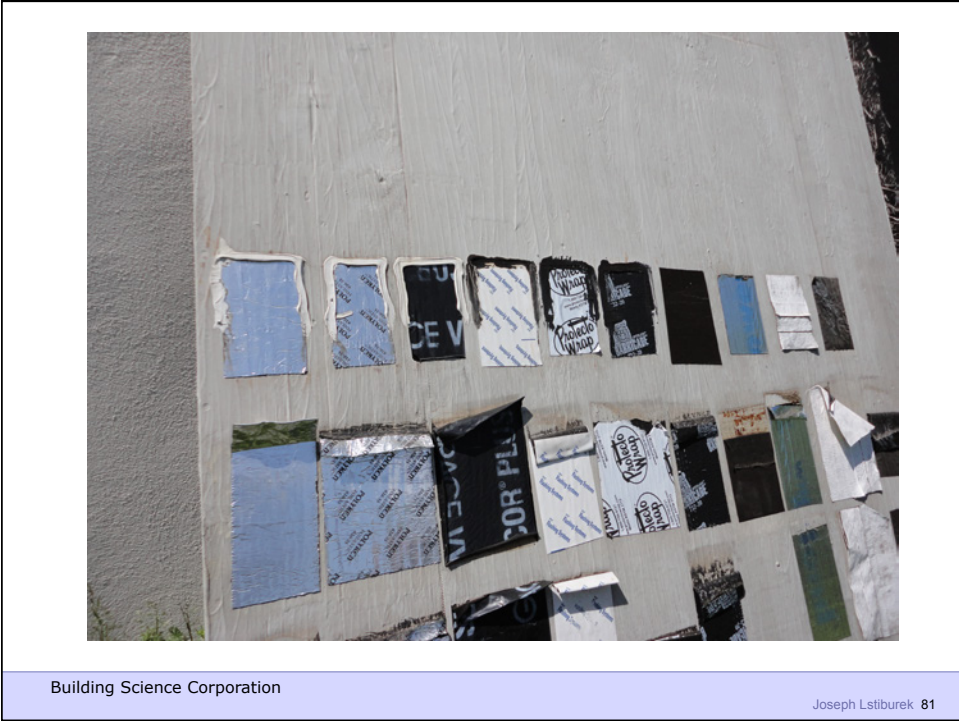

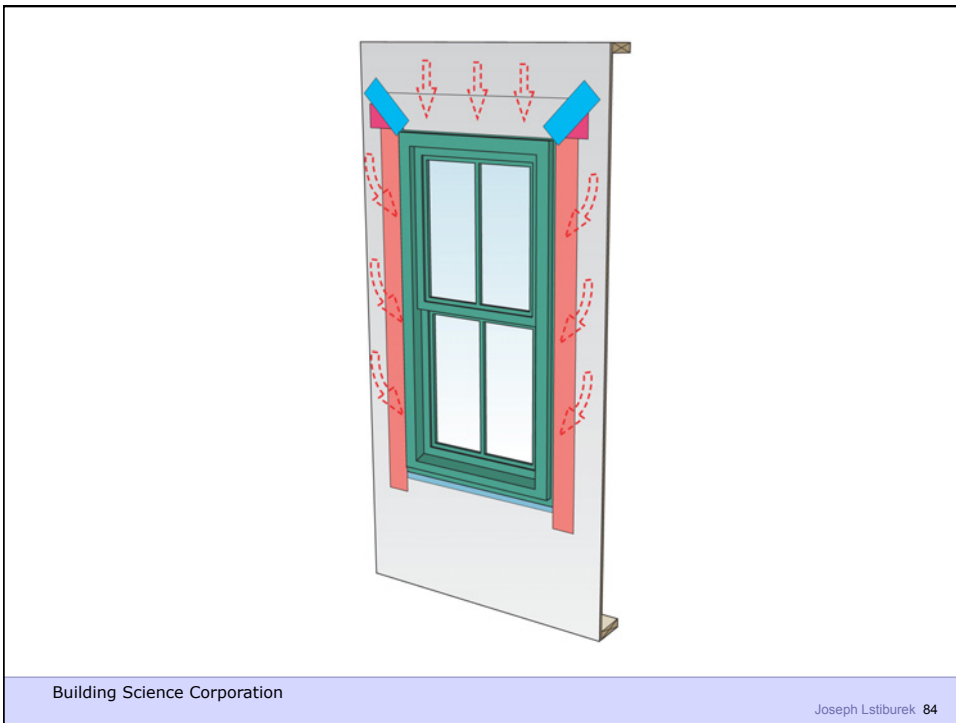

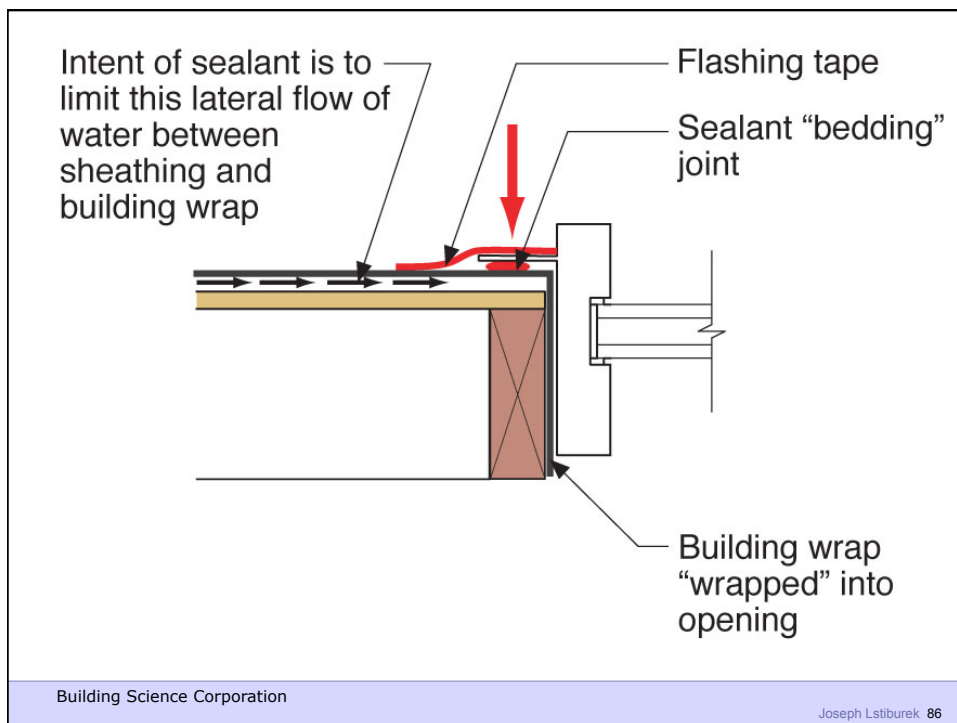

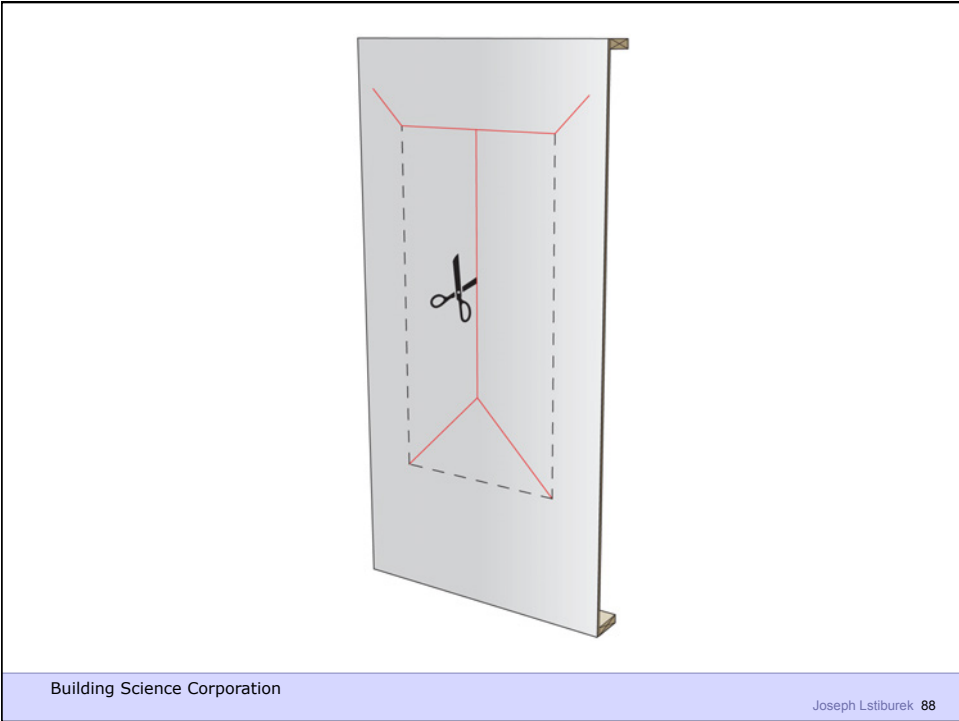
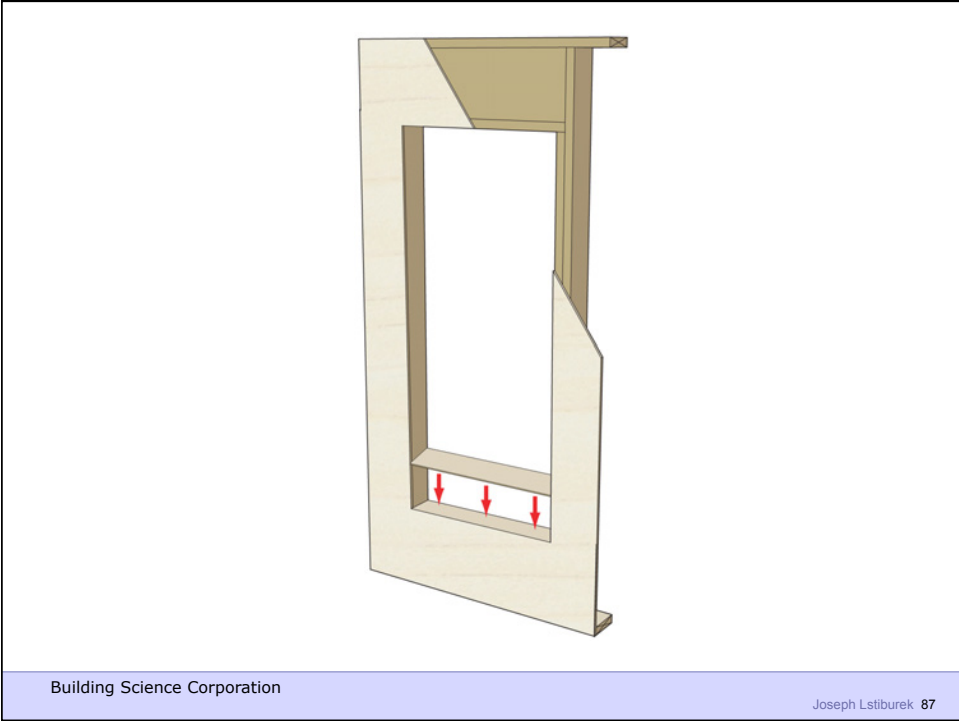

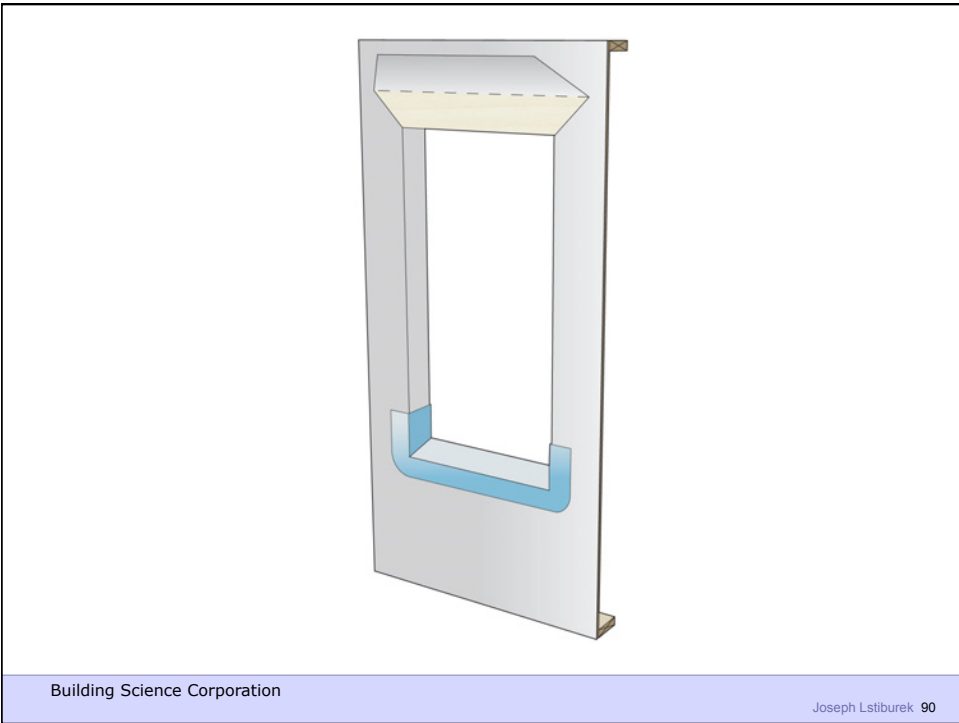
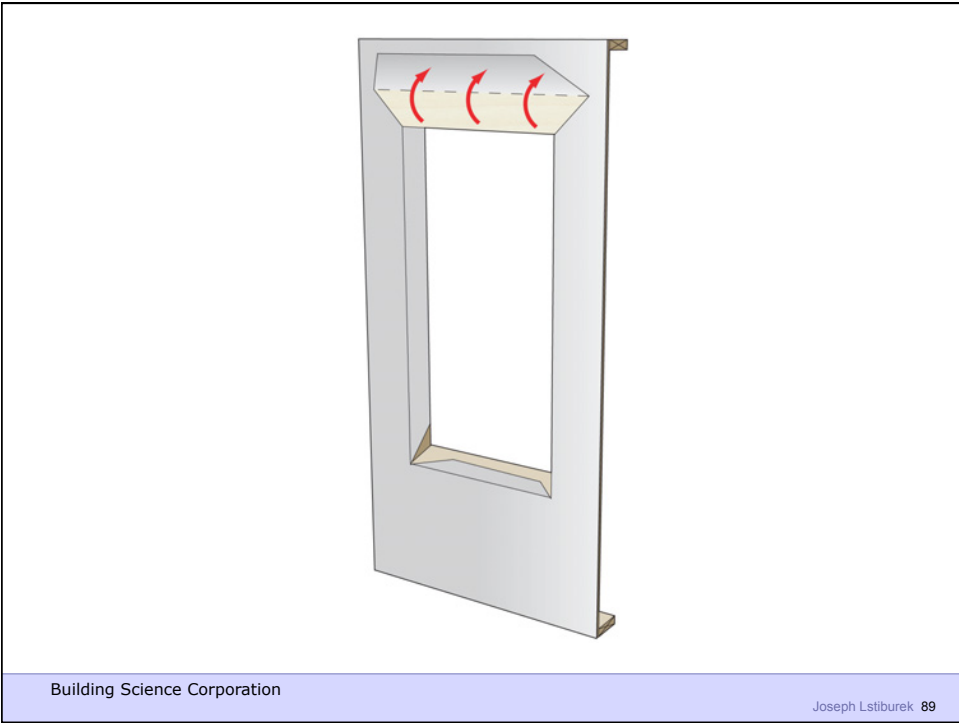

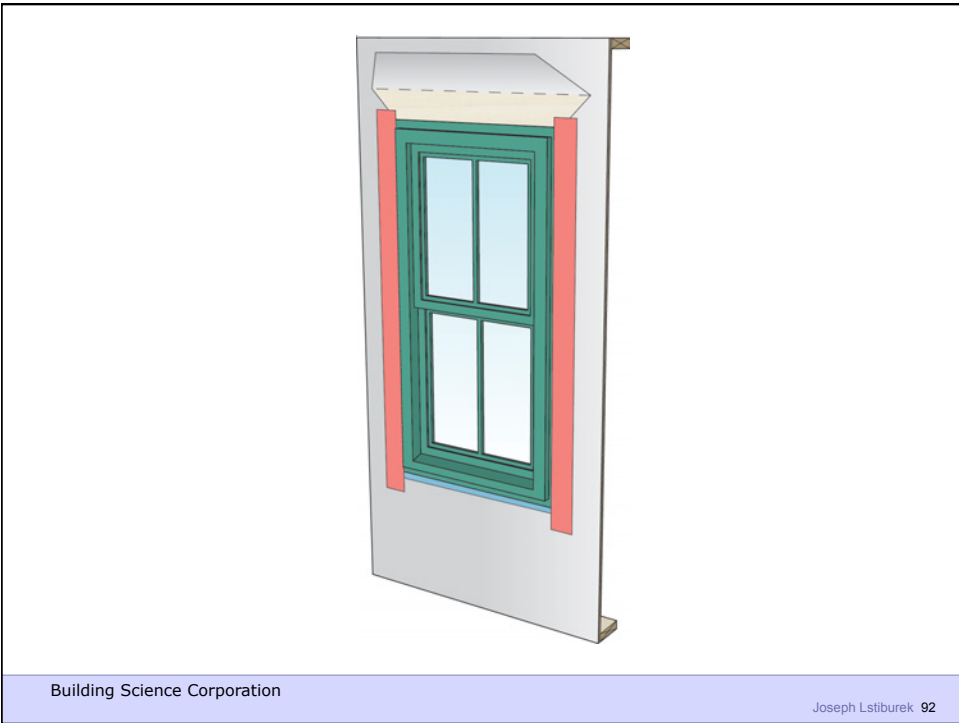
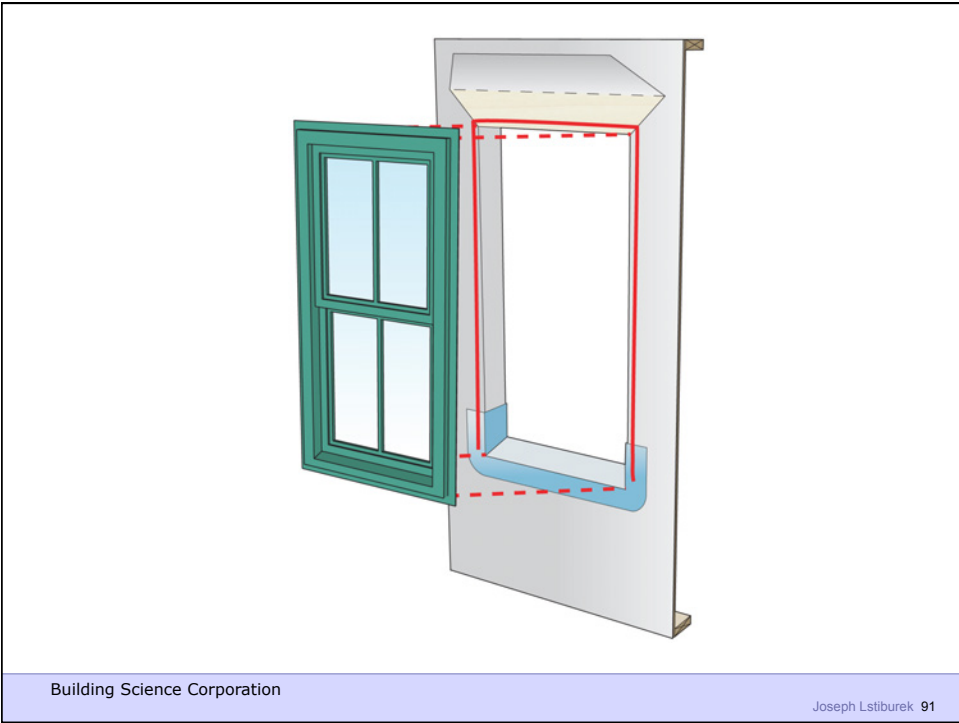





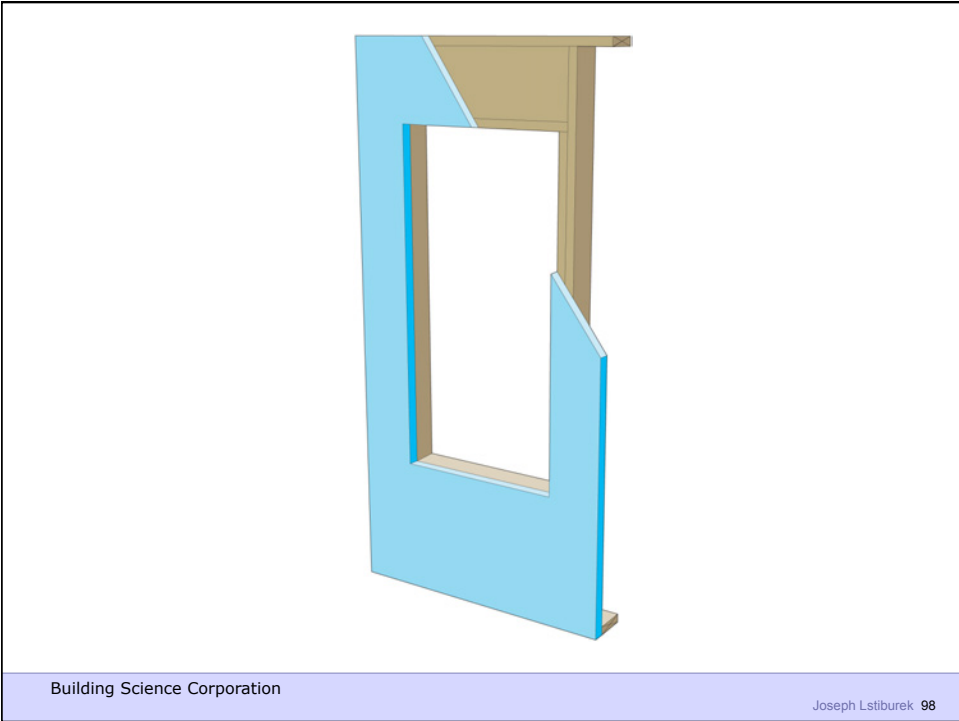

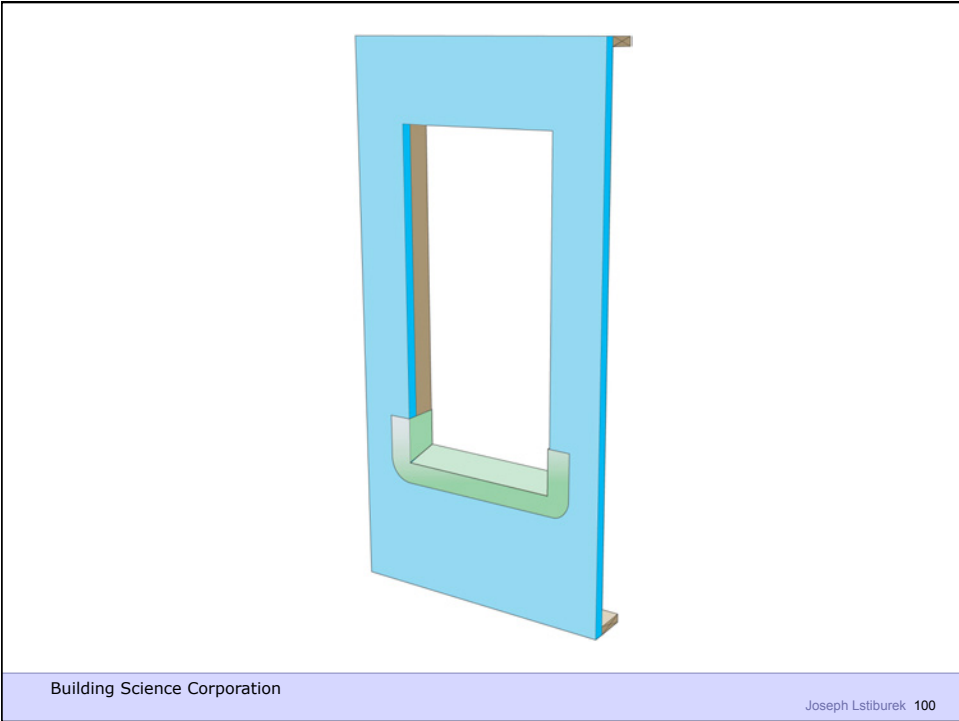
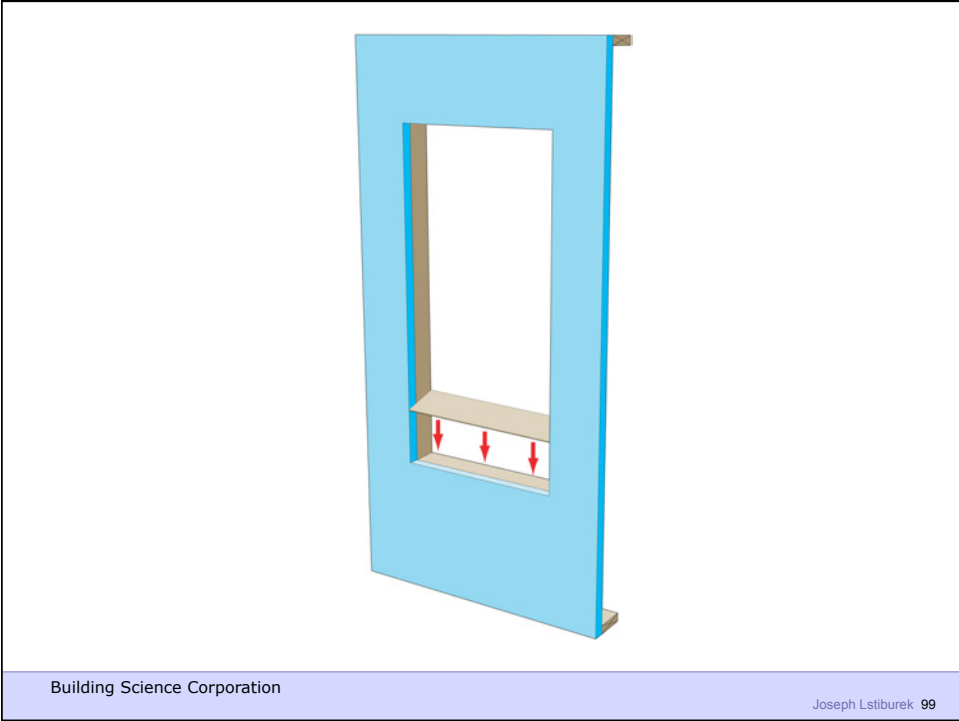

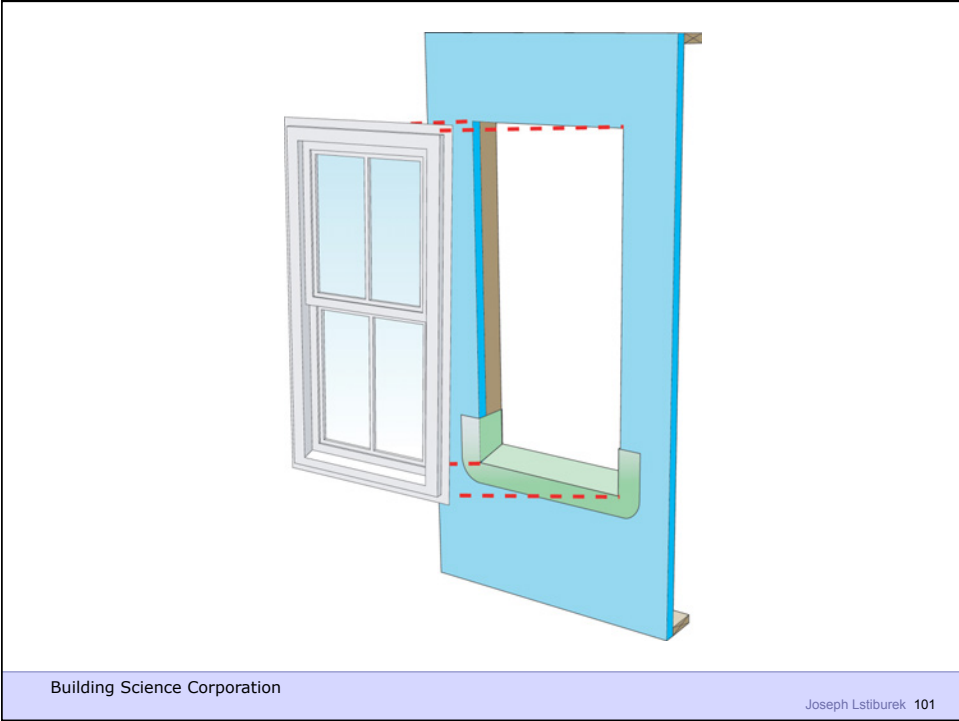



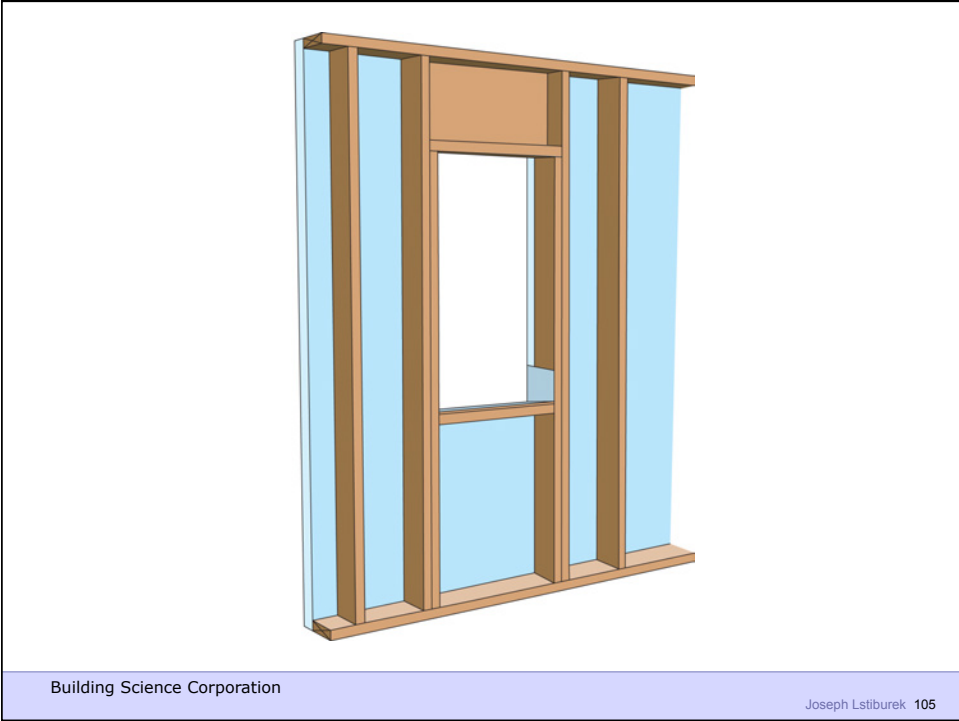

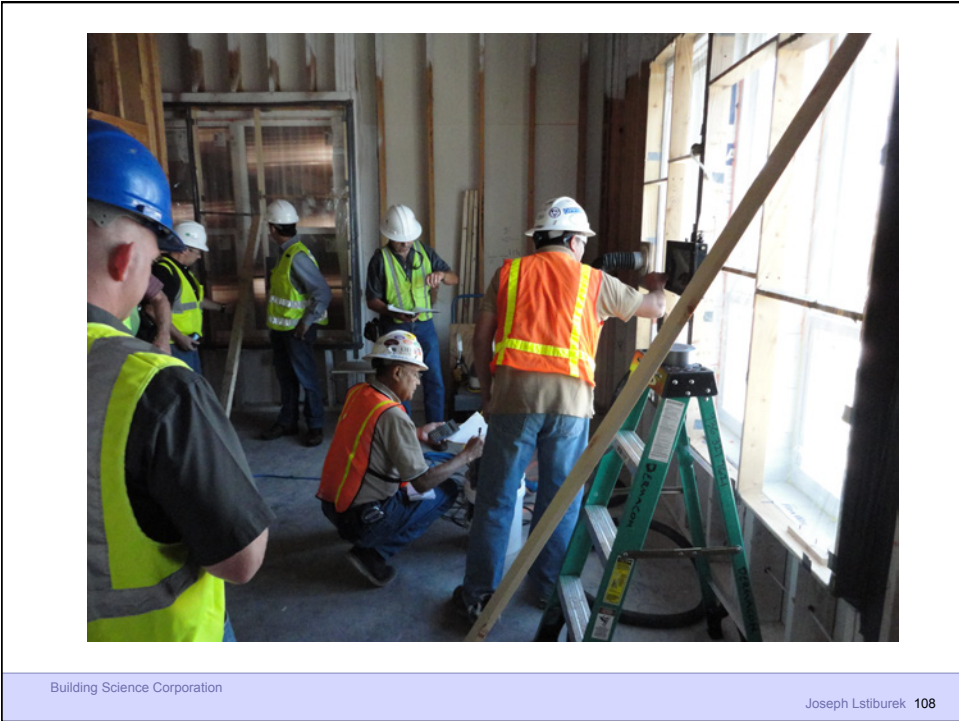



Building Science Corporation

Joseph Lstiburek 109