

Joseph Lstiburek, Ph.D., P.Eng, ASHRAE Fellow

Building Science

Adventures In Building Science

www.buildingscience.com

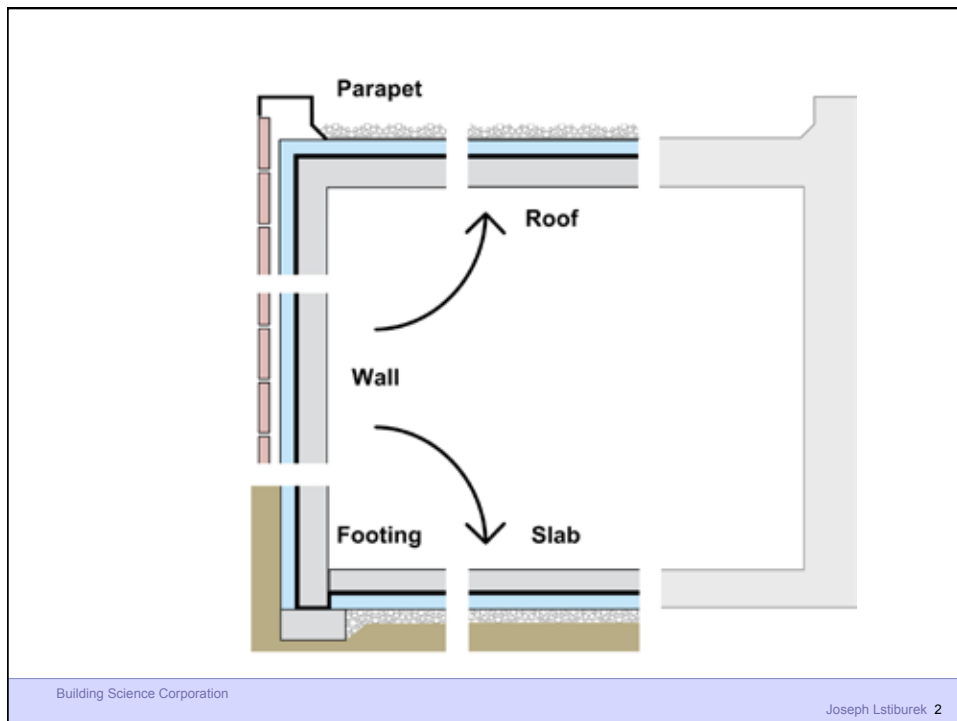

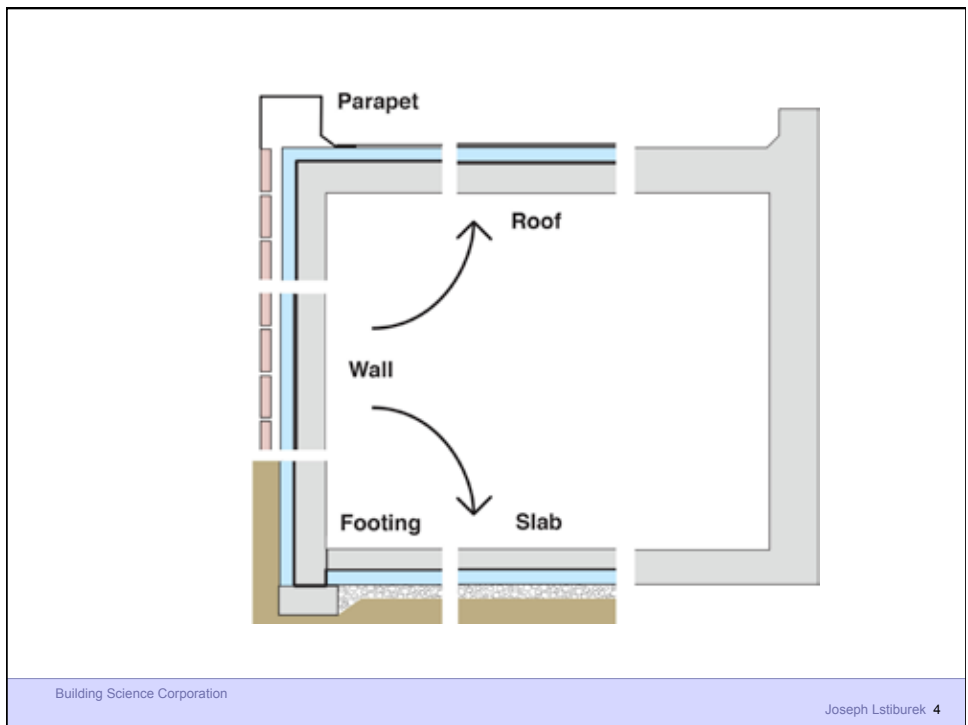
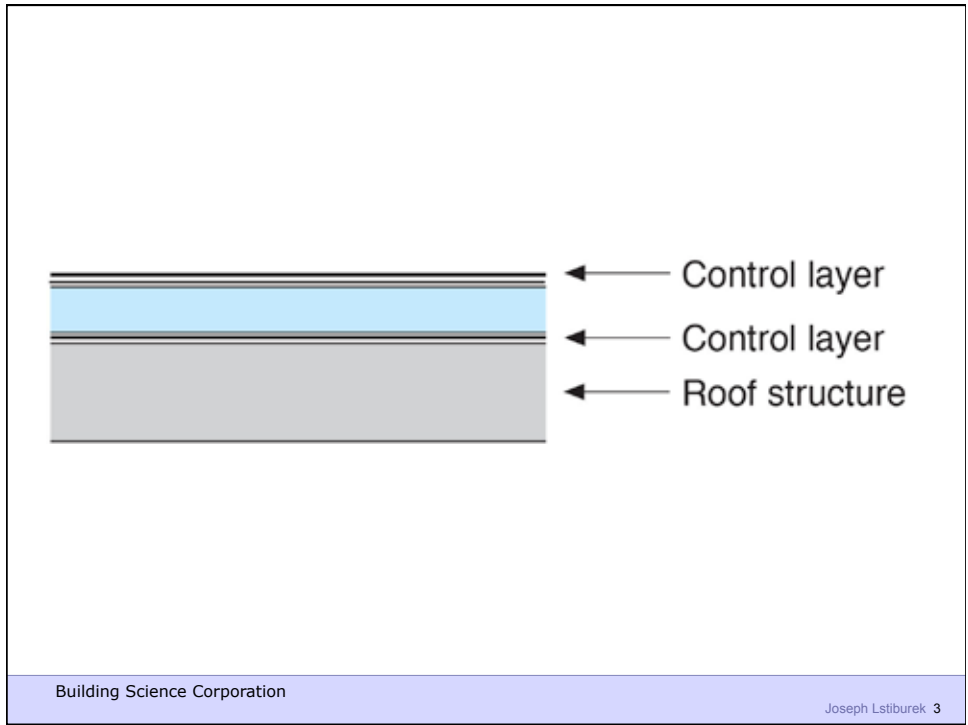

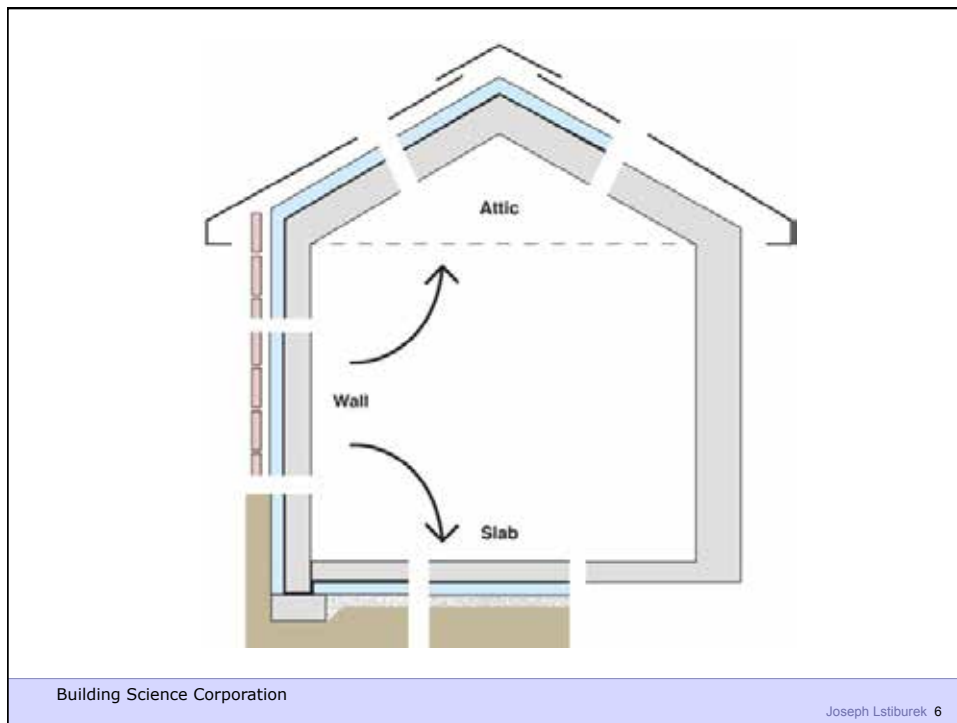
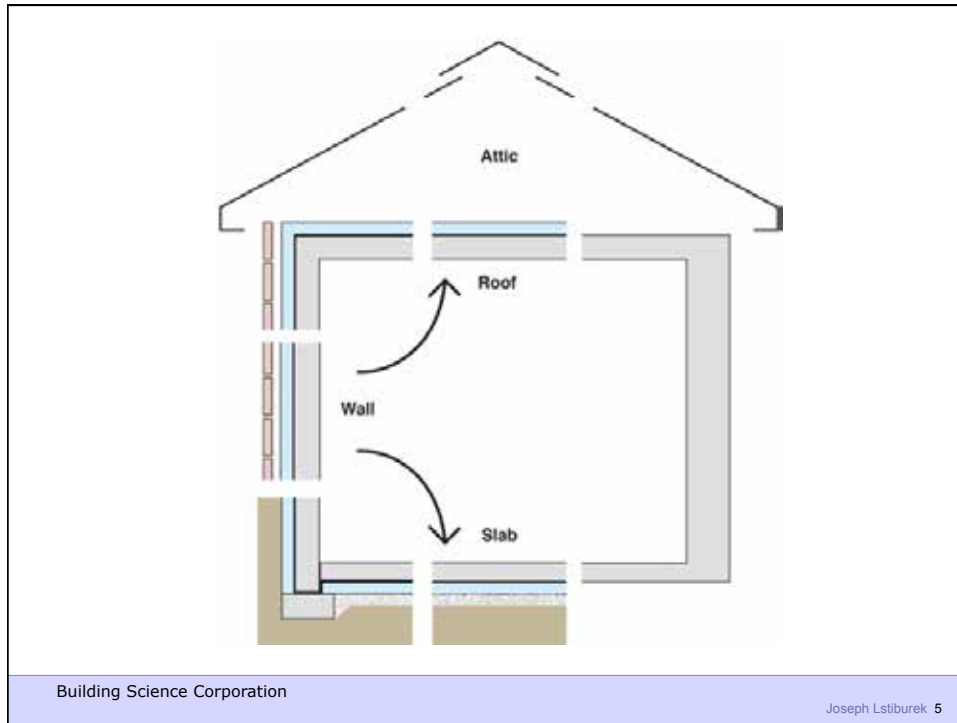

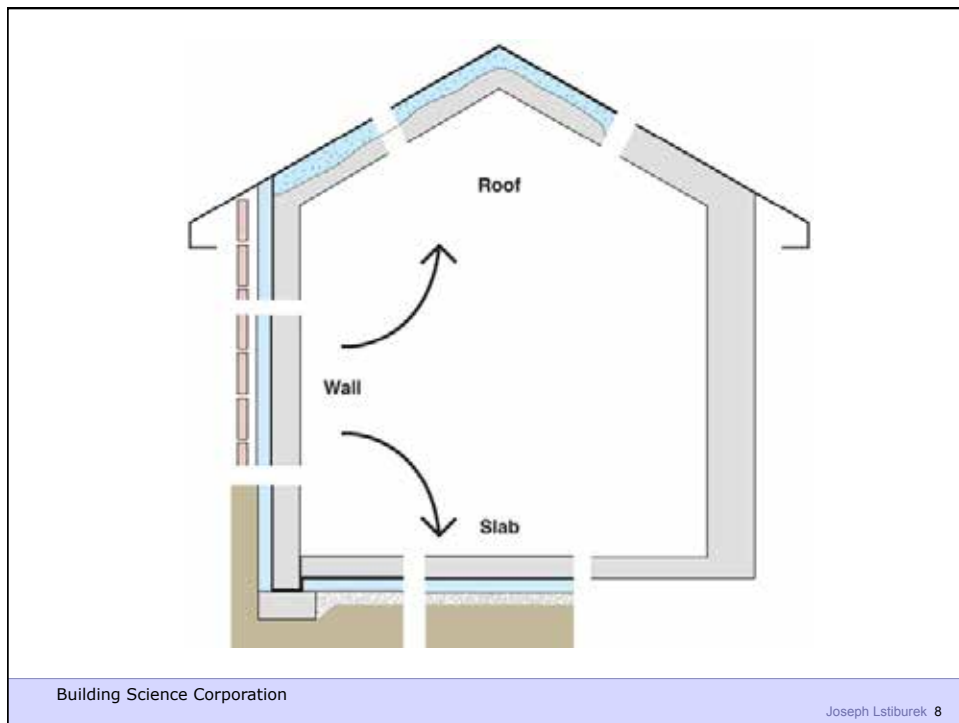
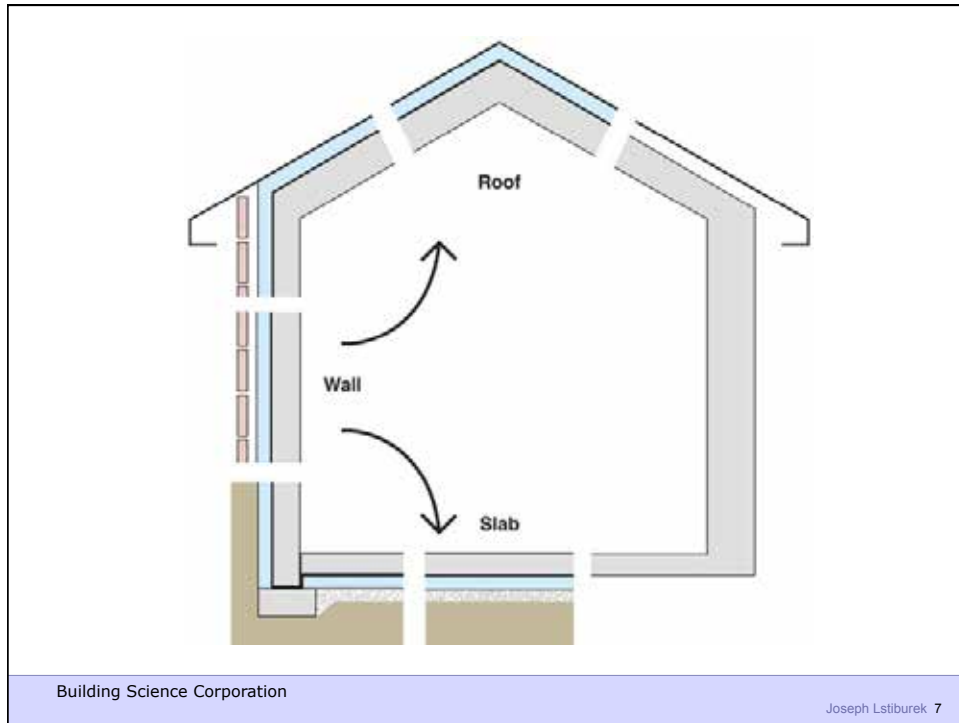

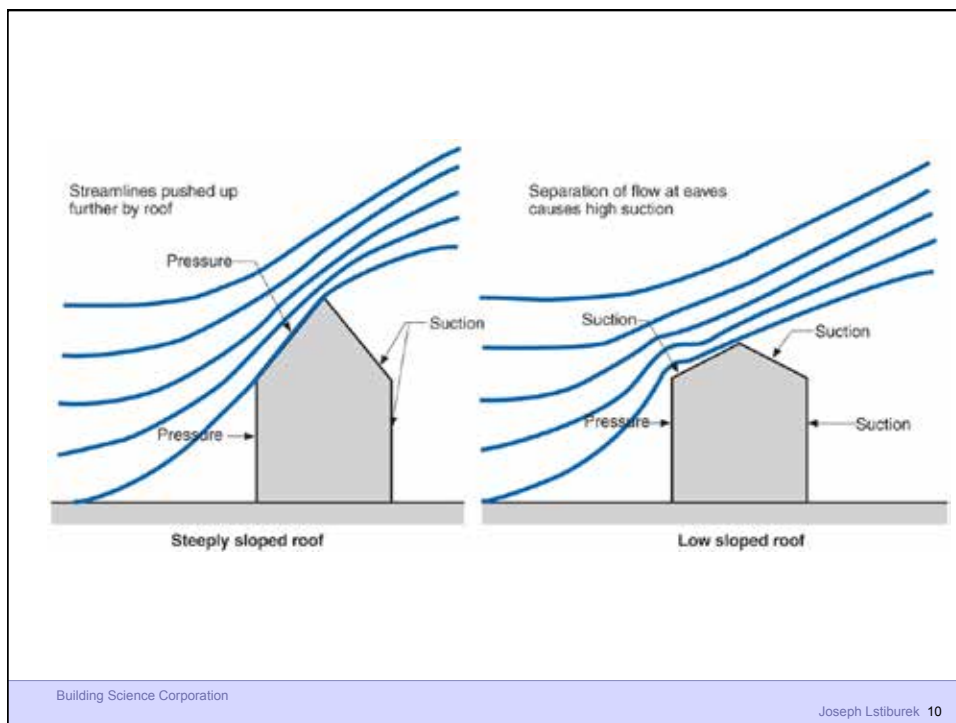
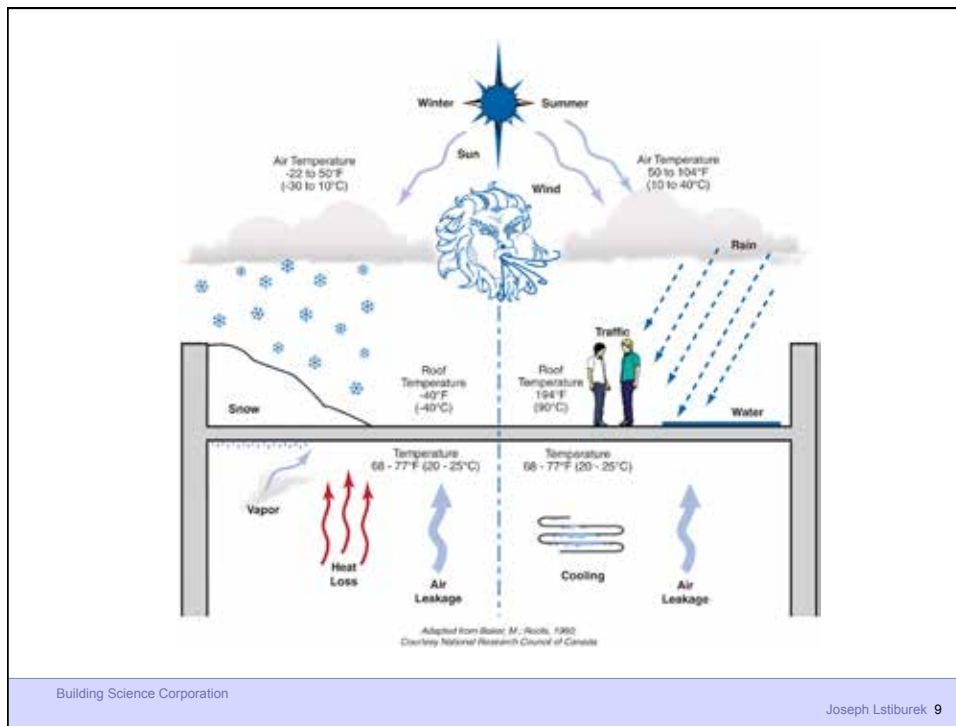

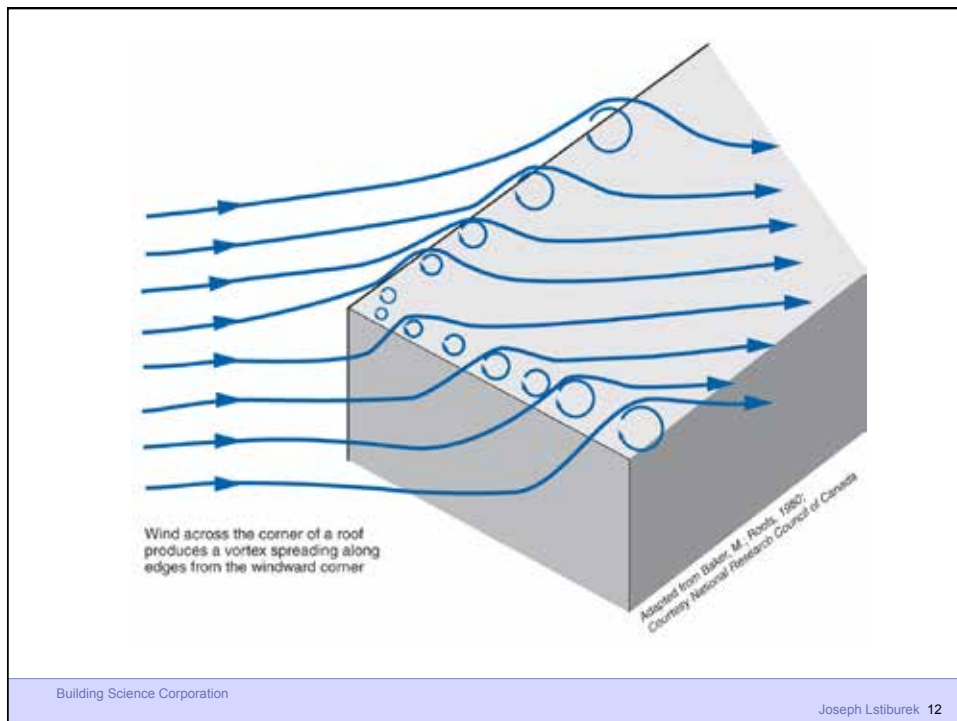
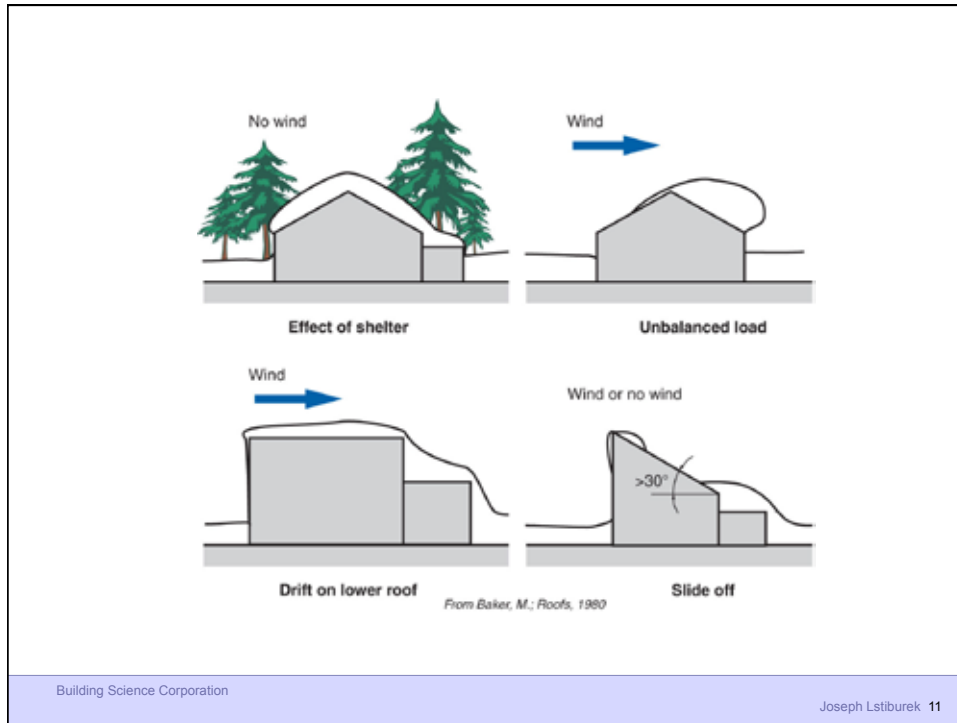

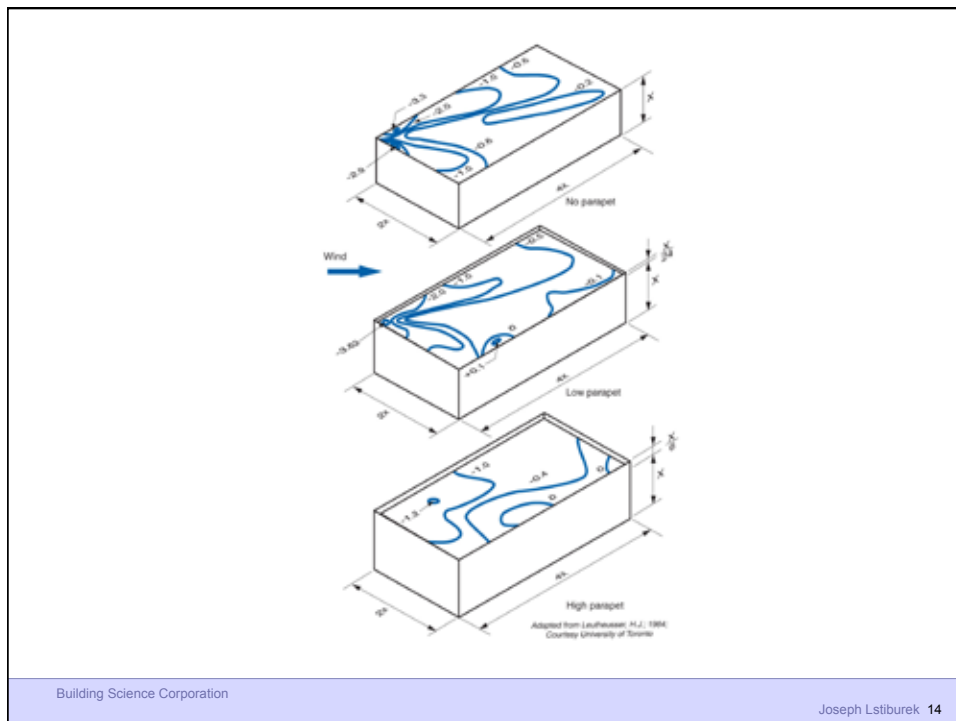
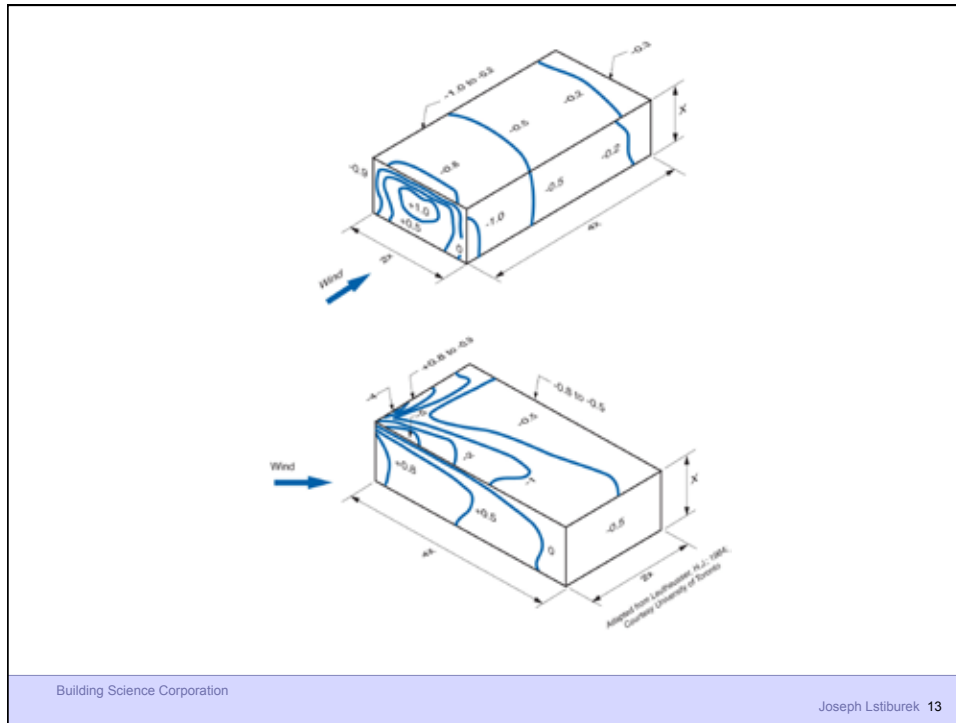

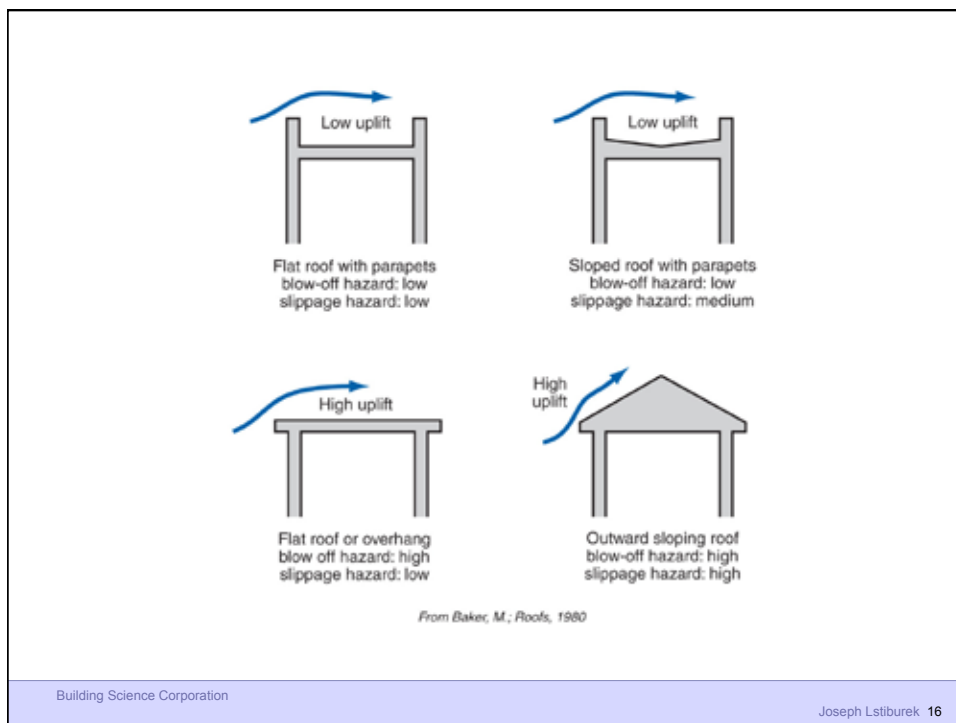
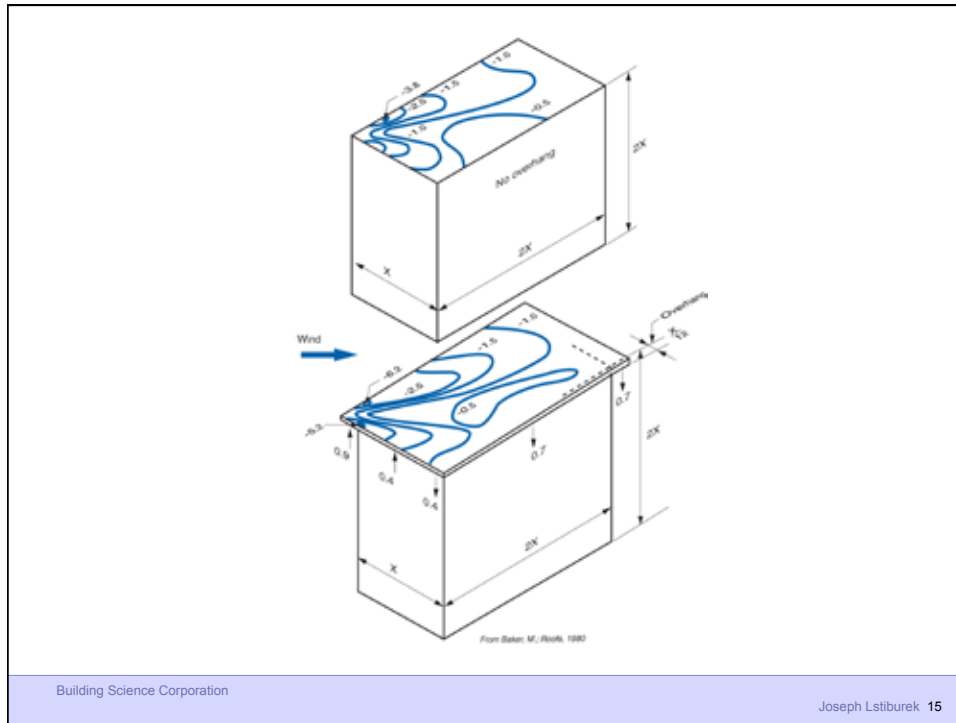

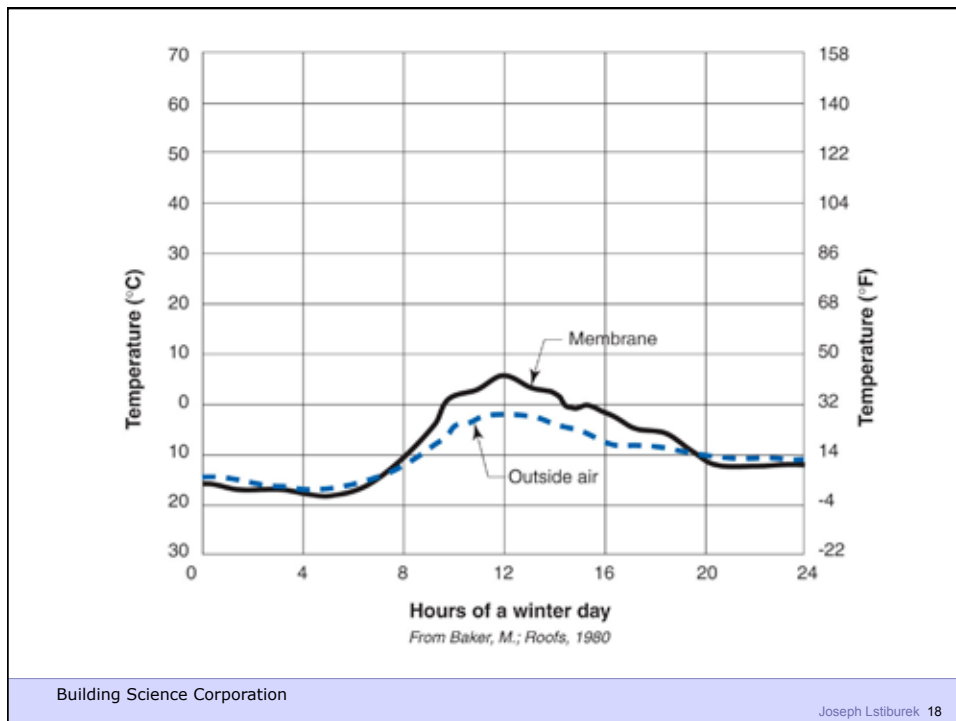
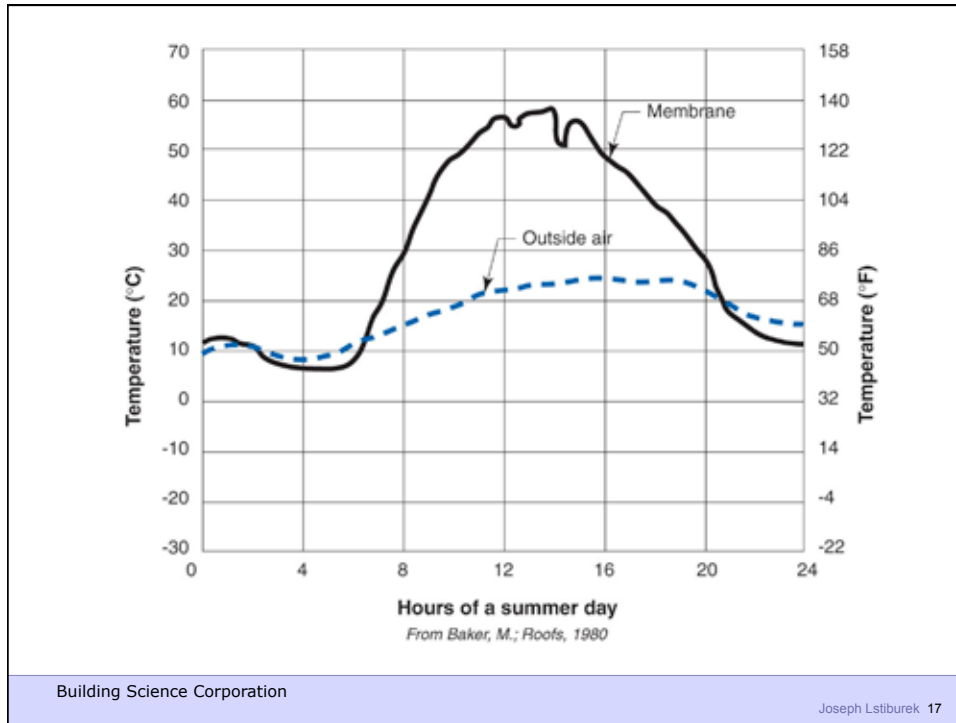

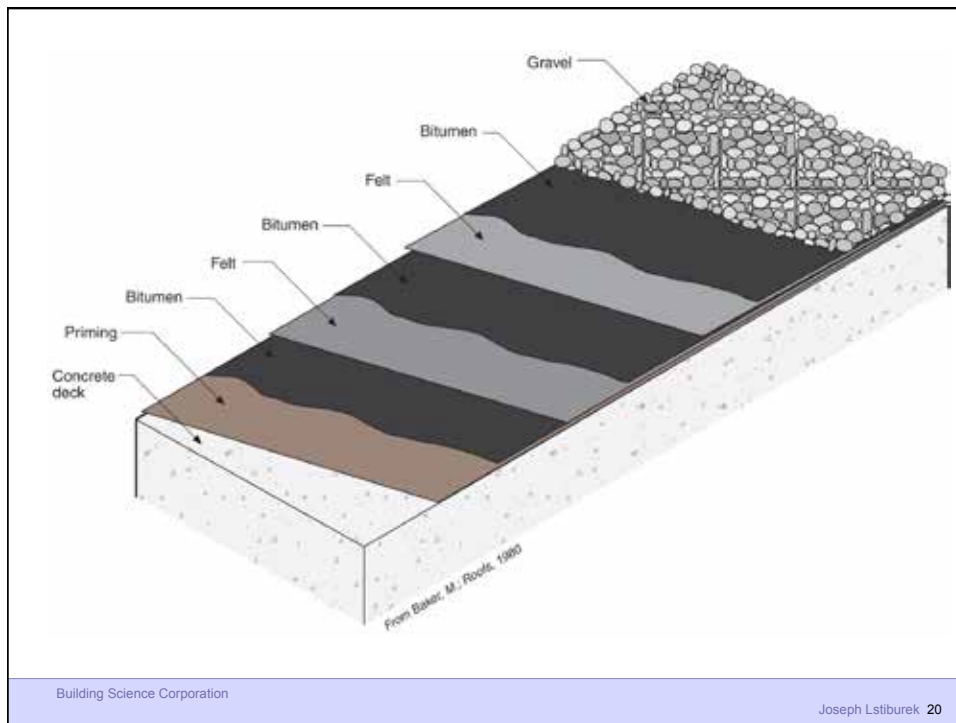
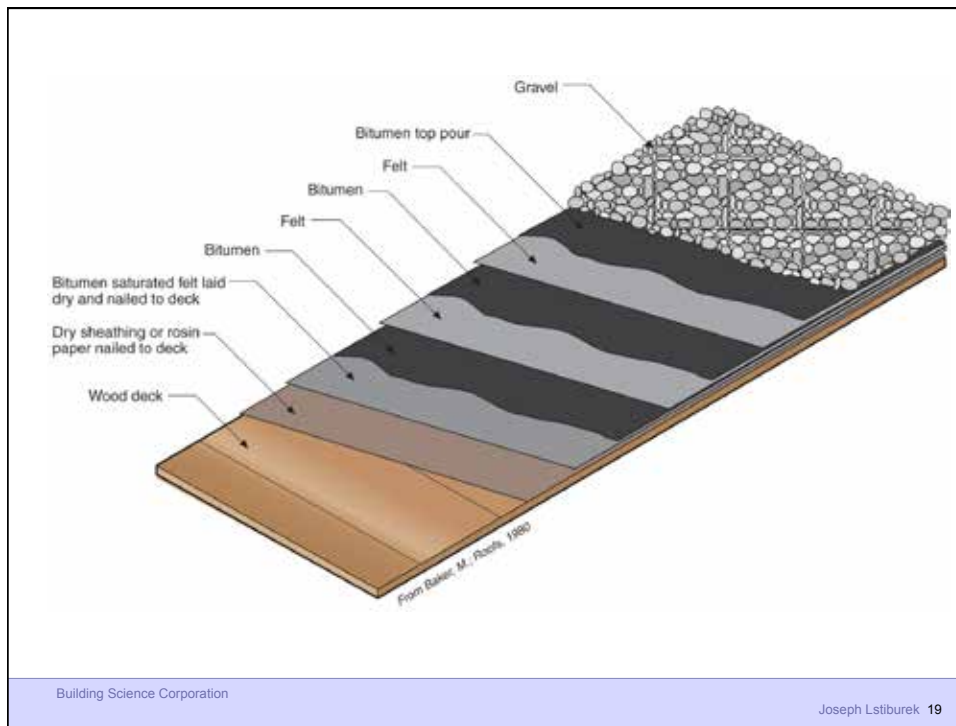

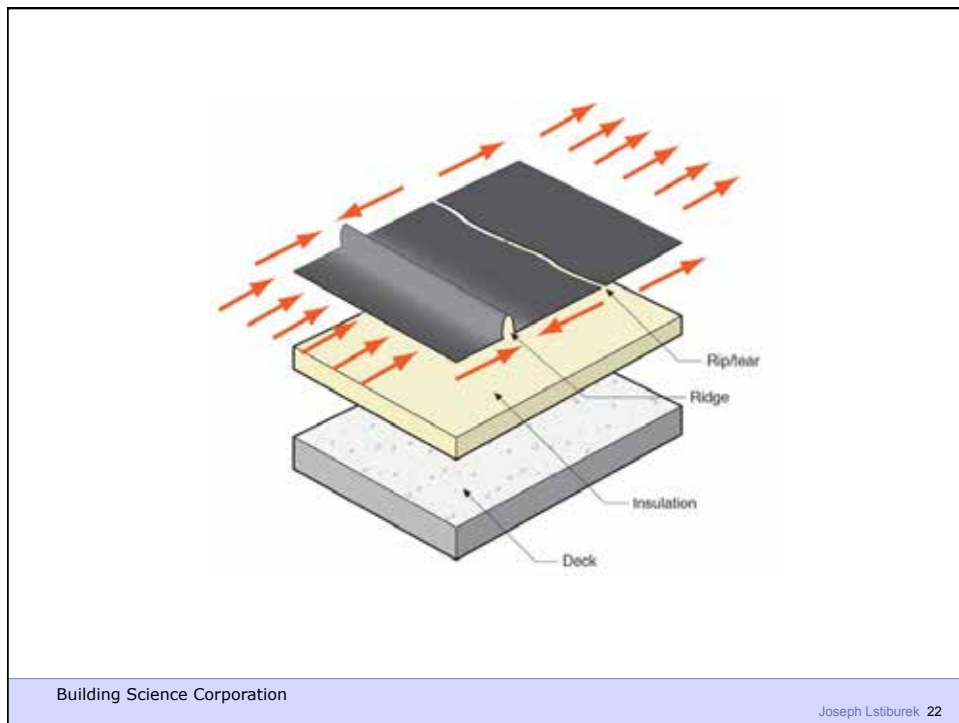
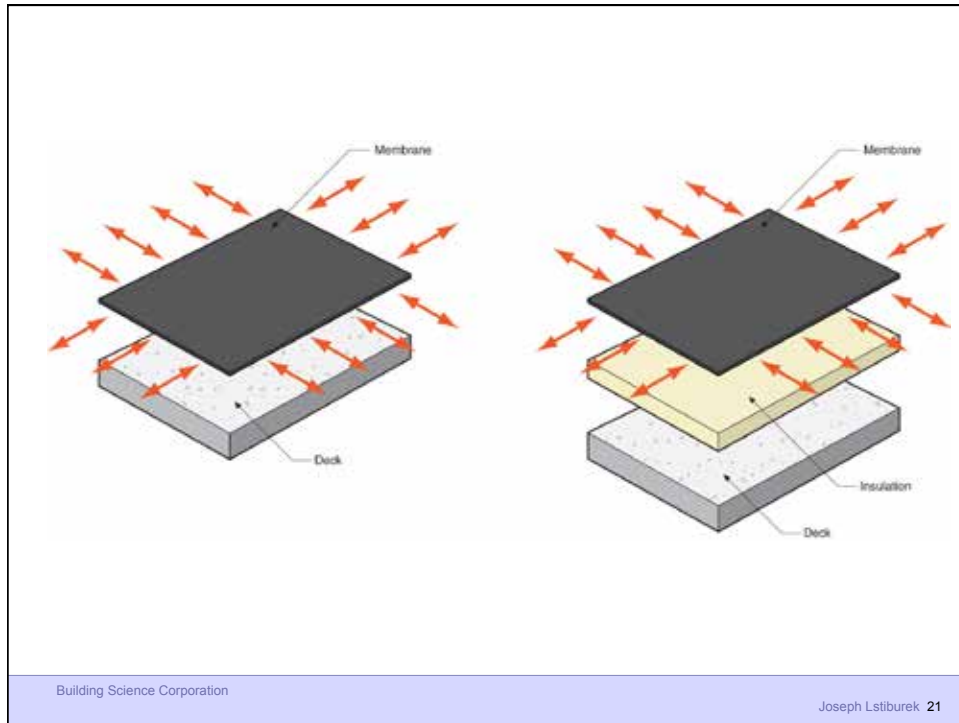

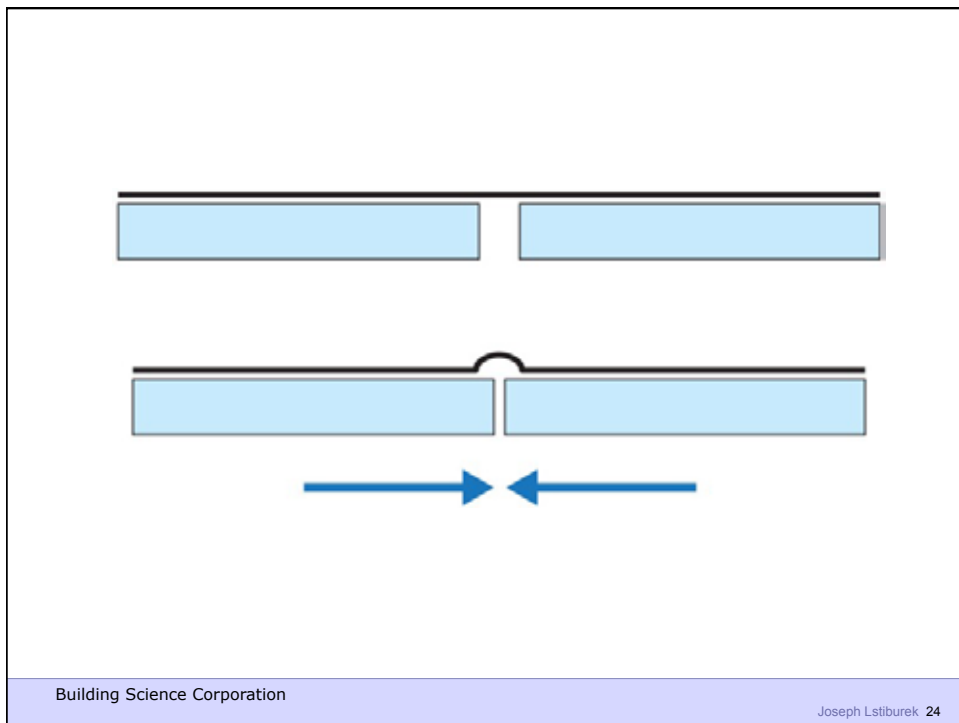



Building Science Corporation

Joseph Lstiburek 25

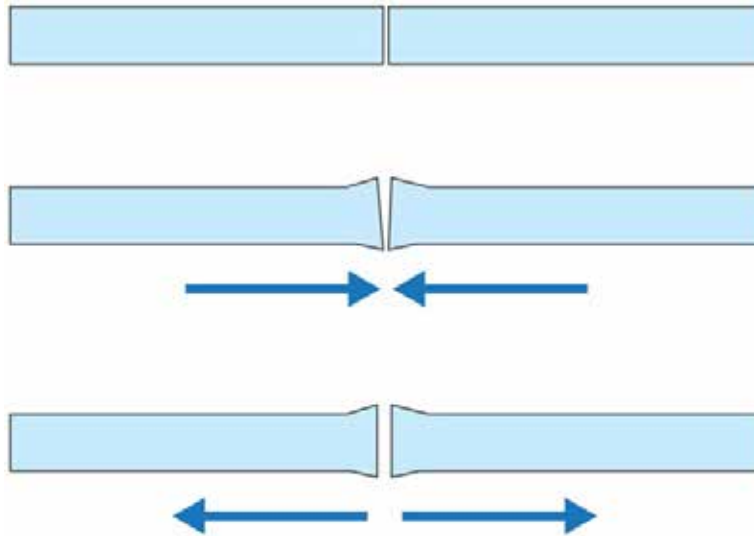

Building Science Corporation

Joseph Lstiburek 26

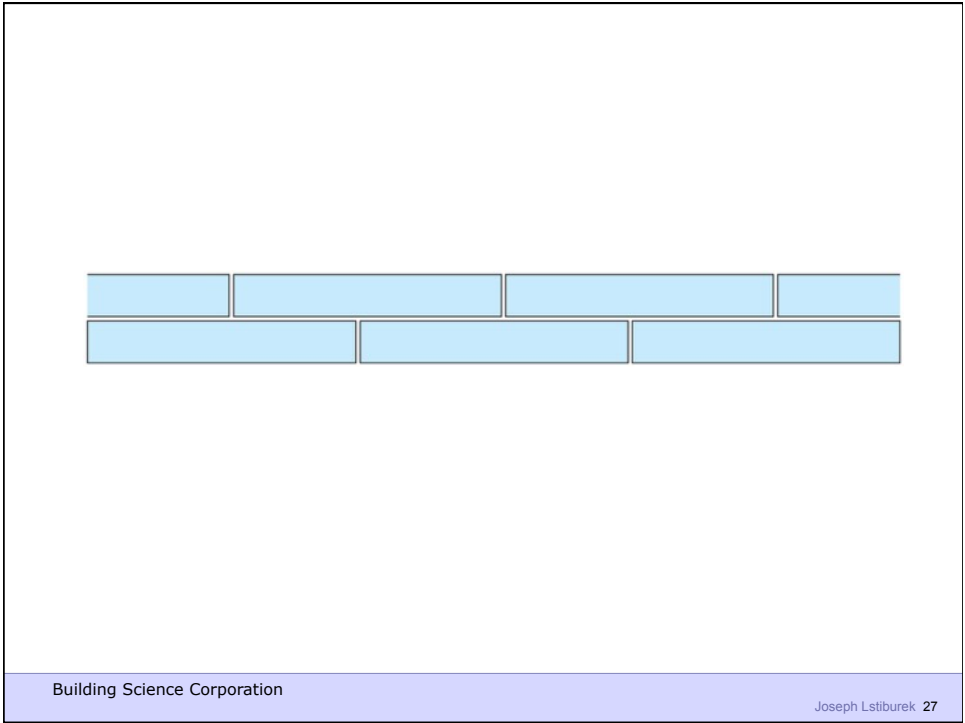

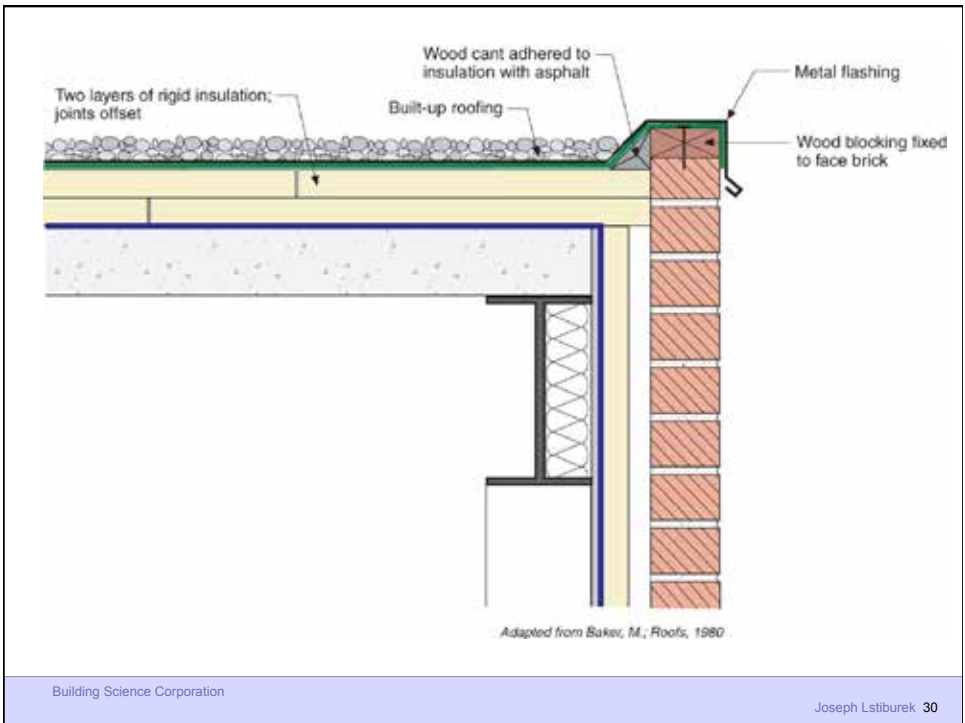
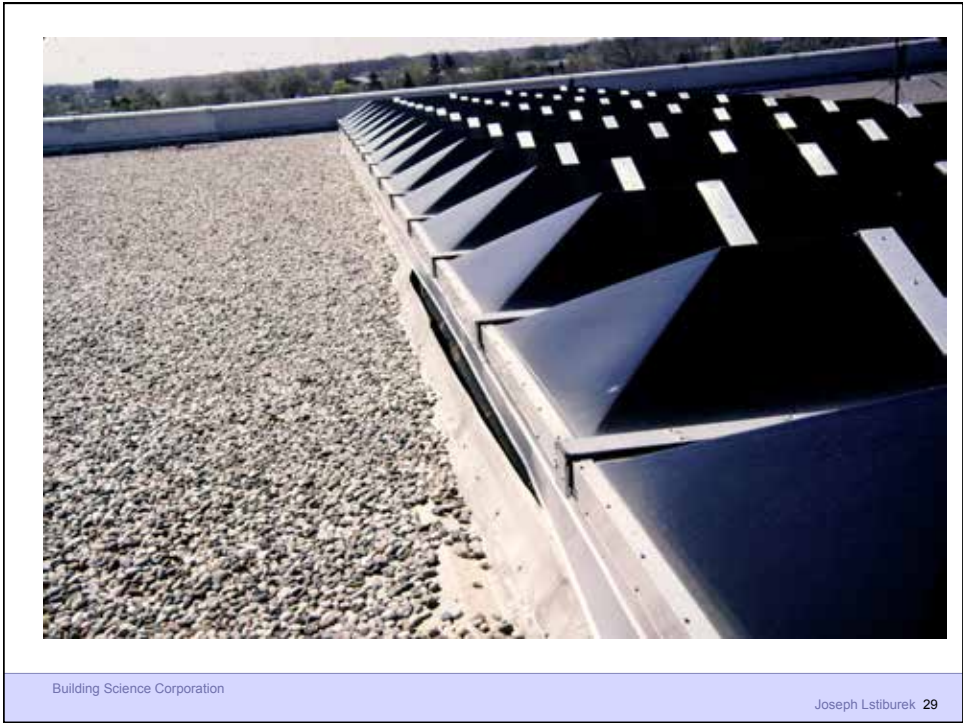

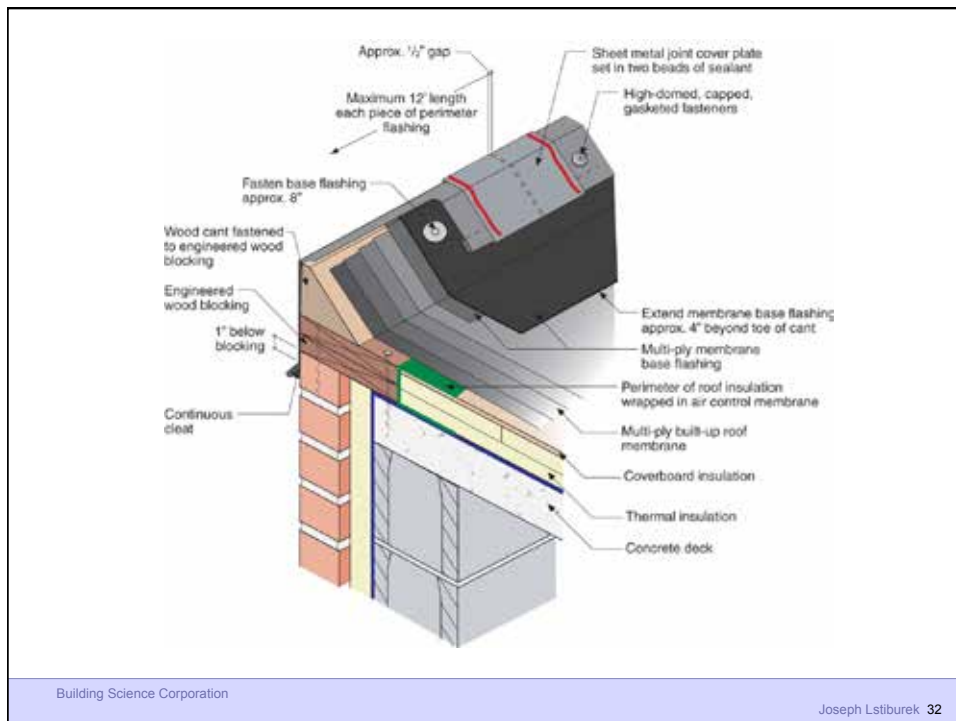
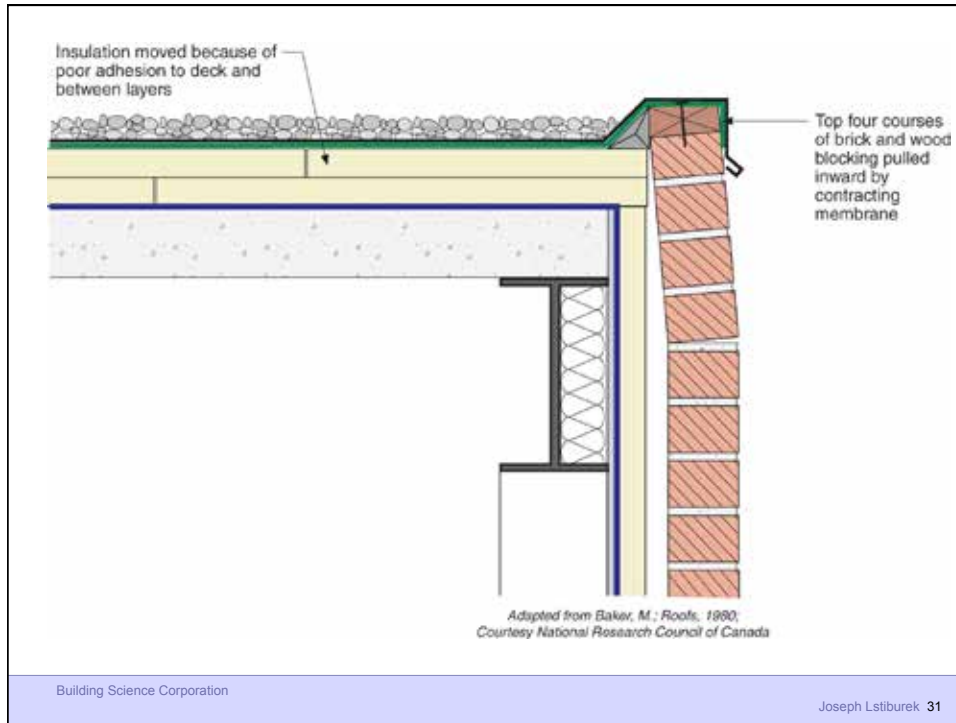

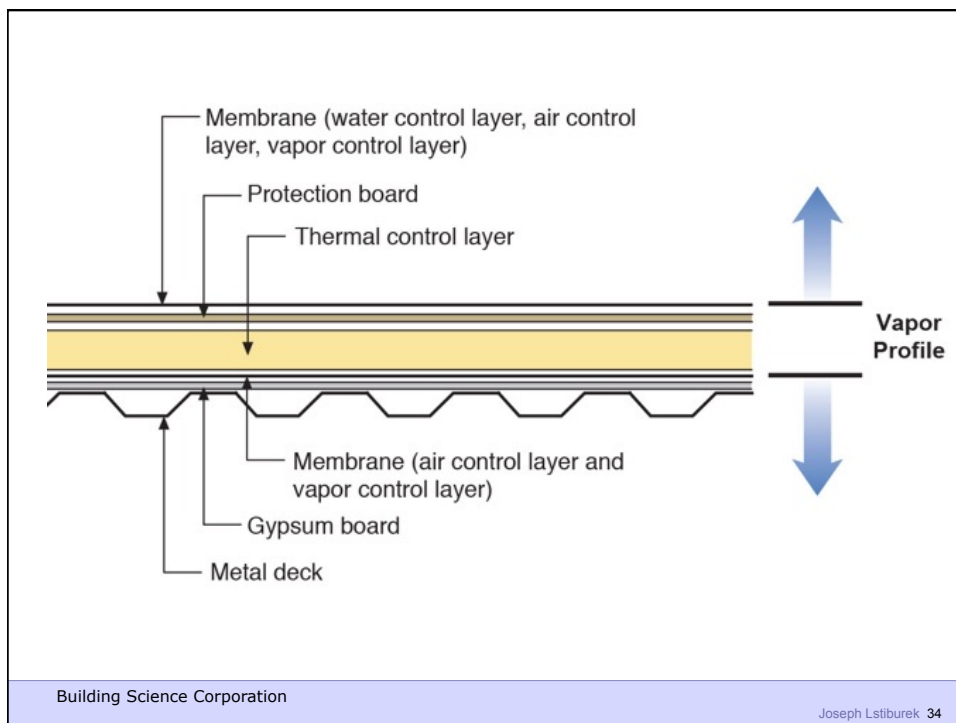
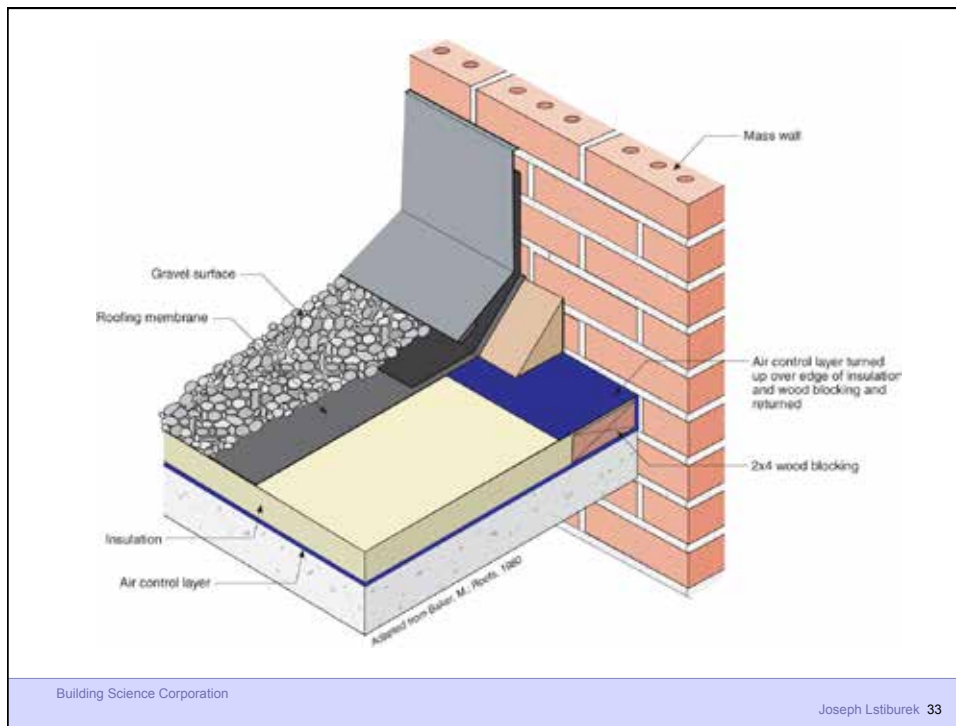

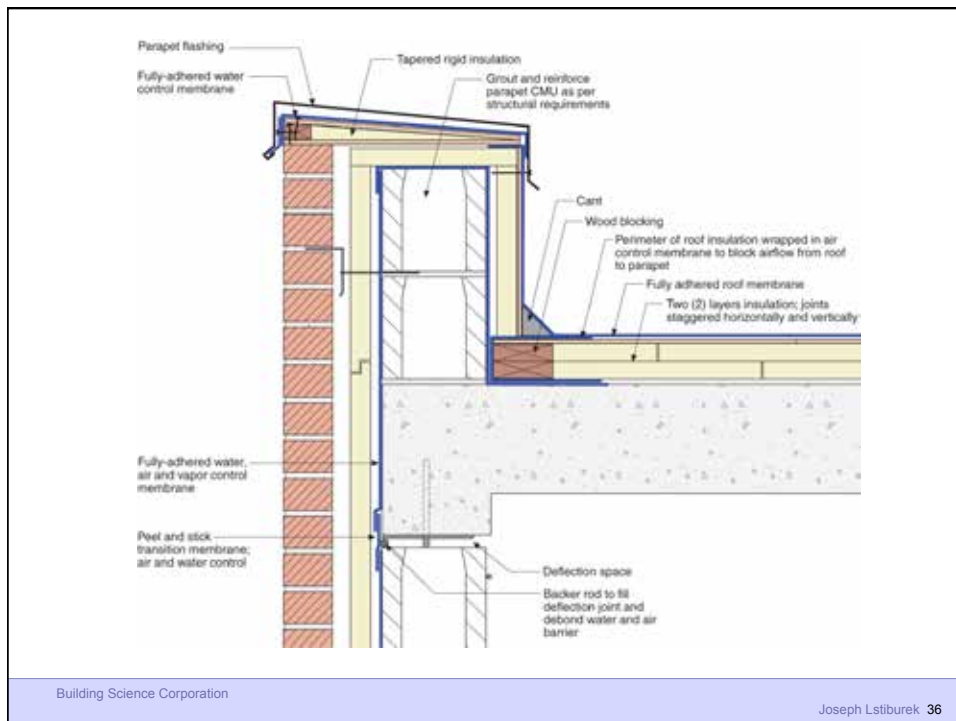
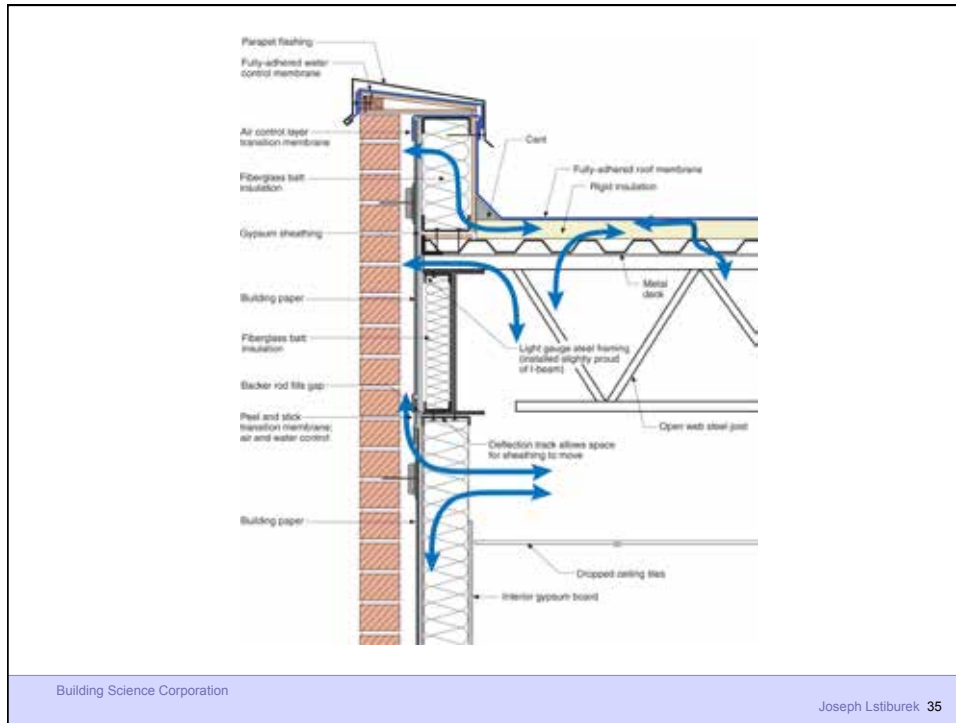

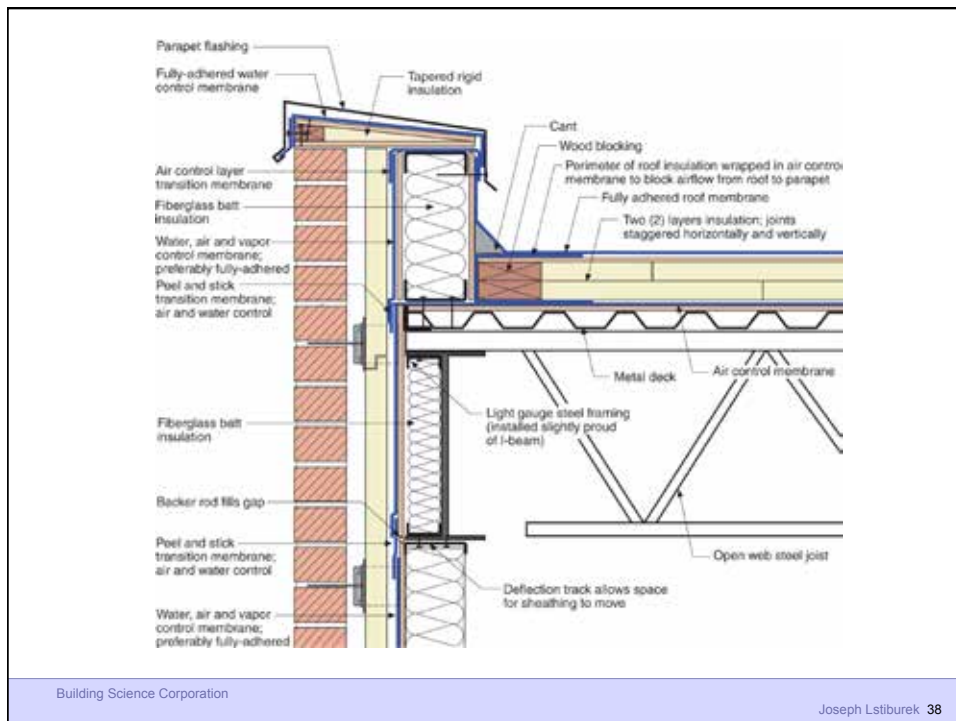
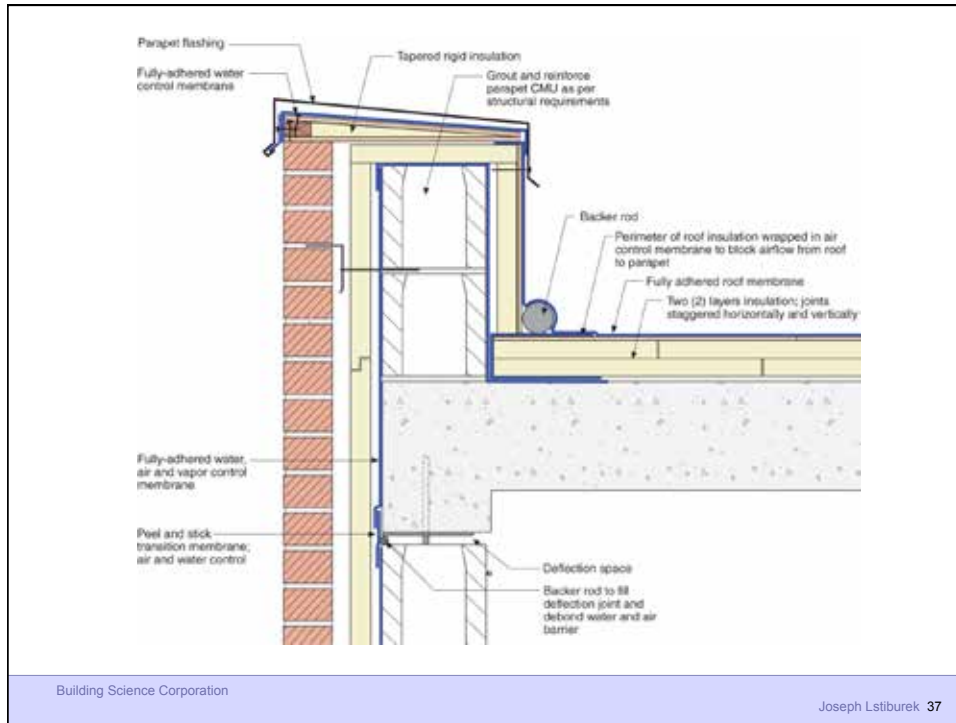

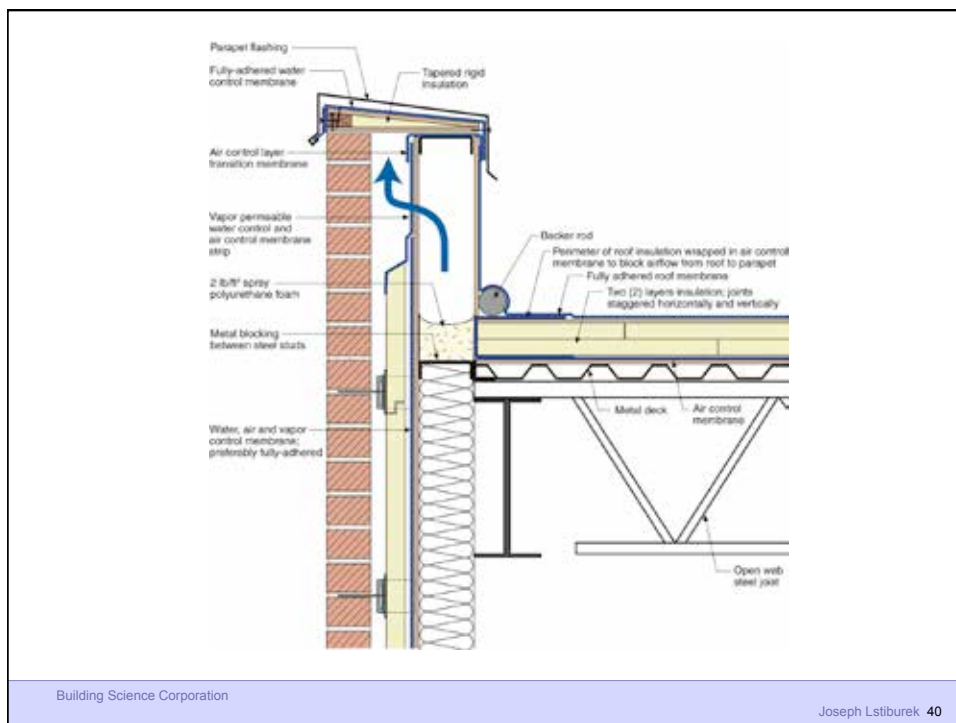
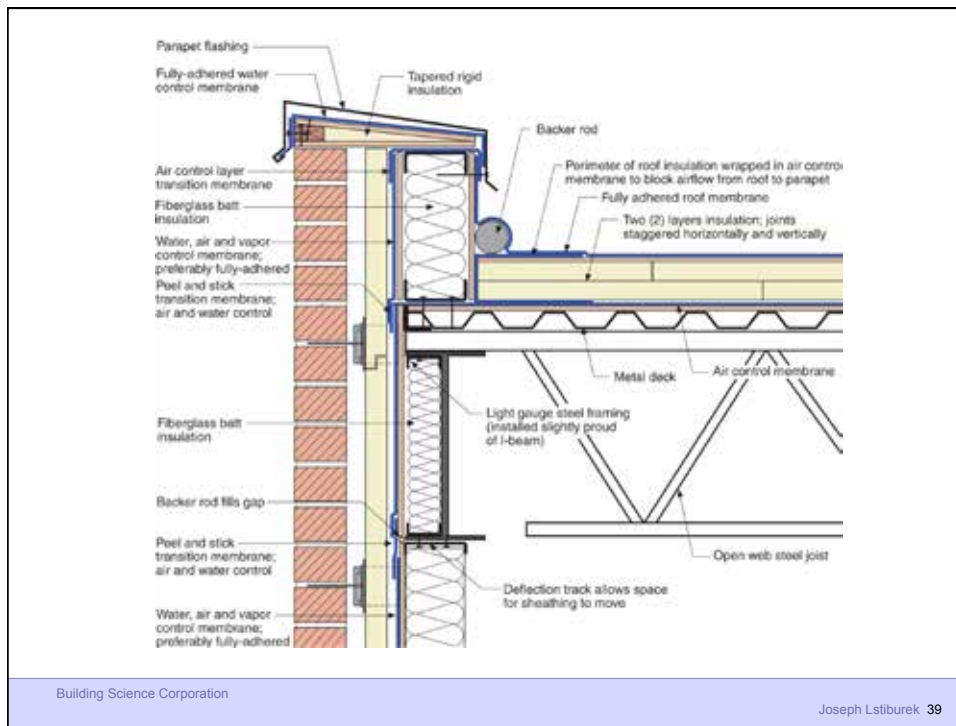

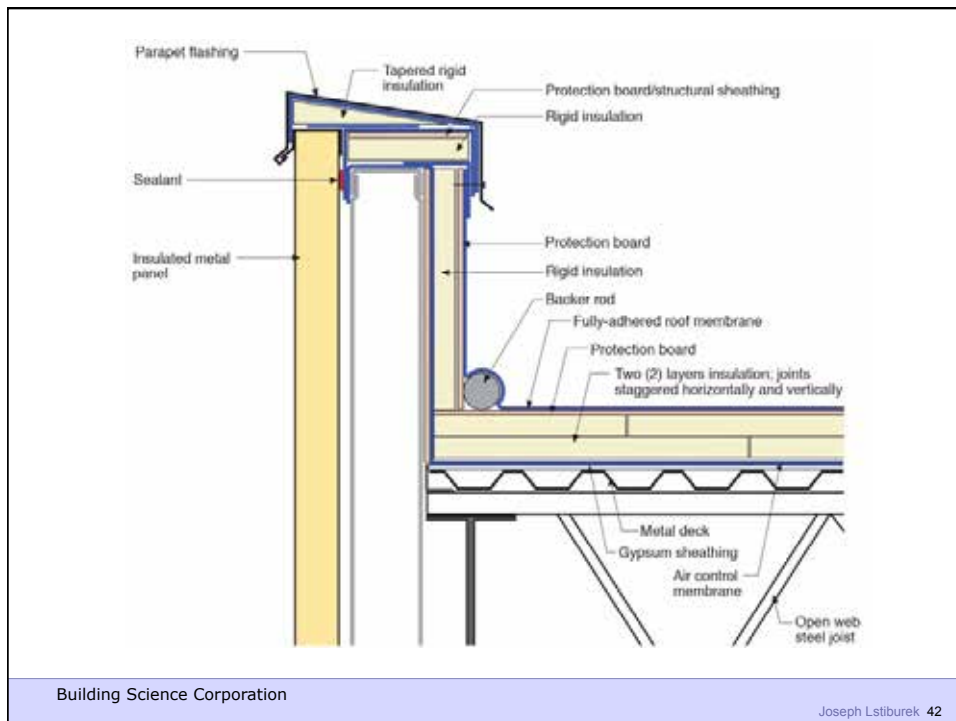
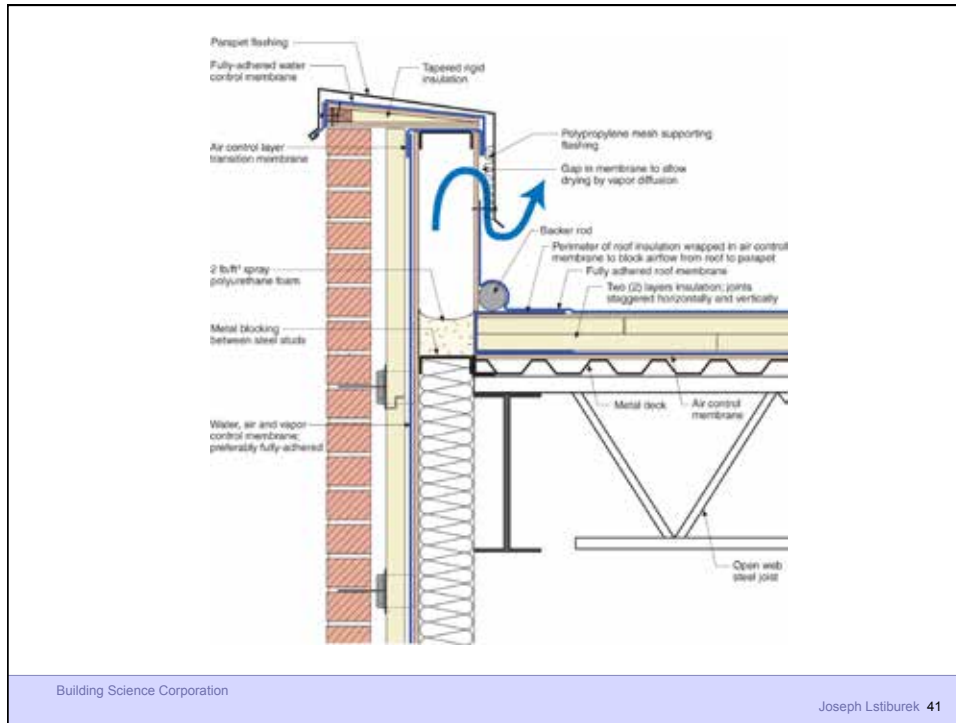

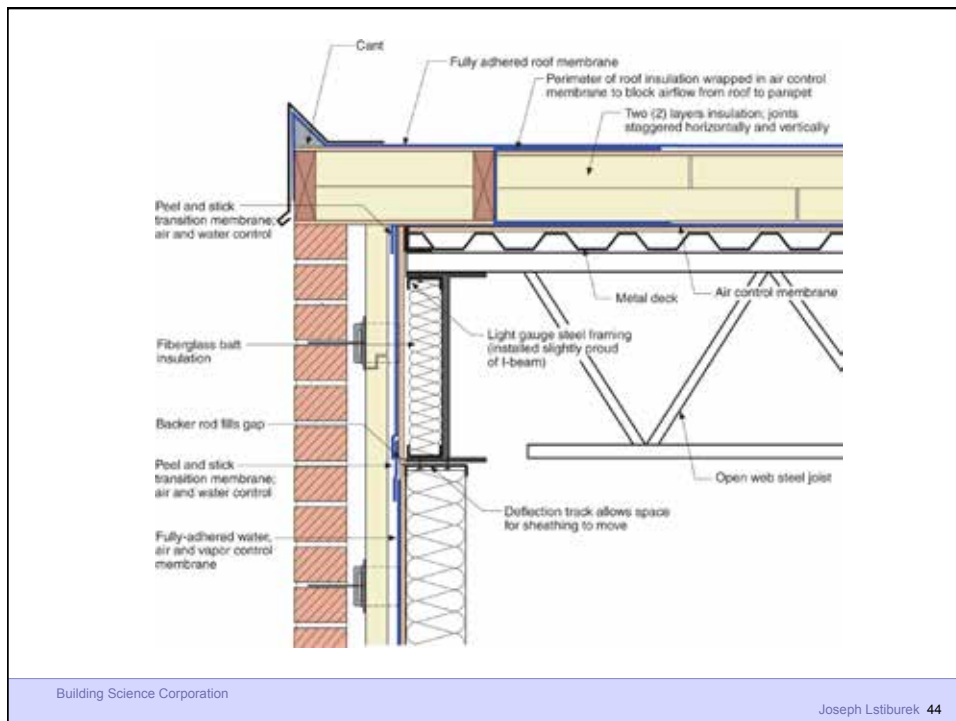
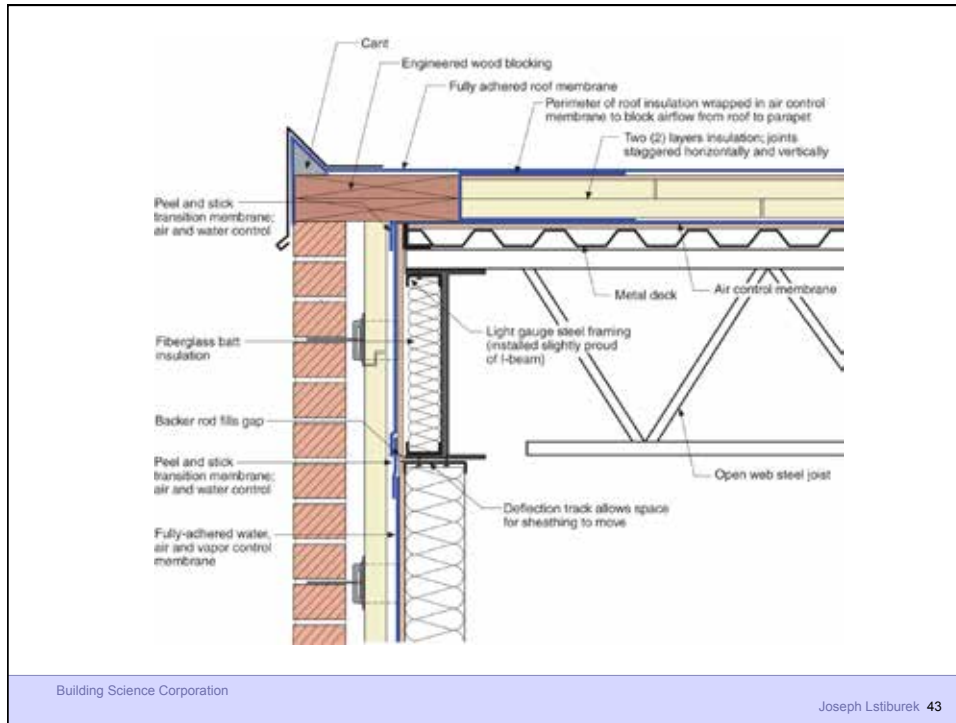

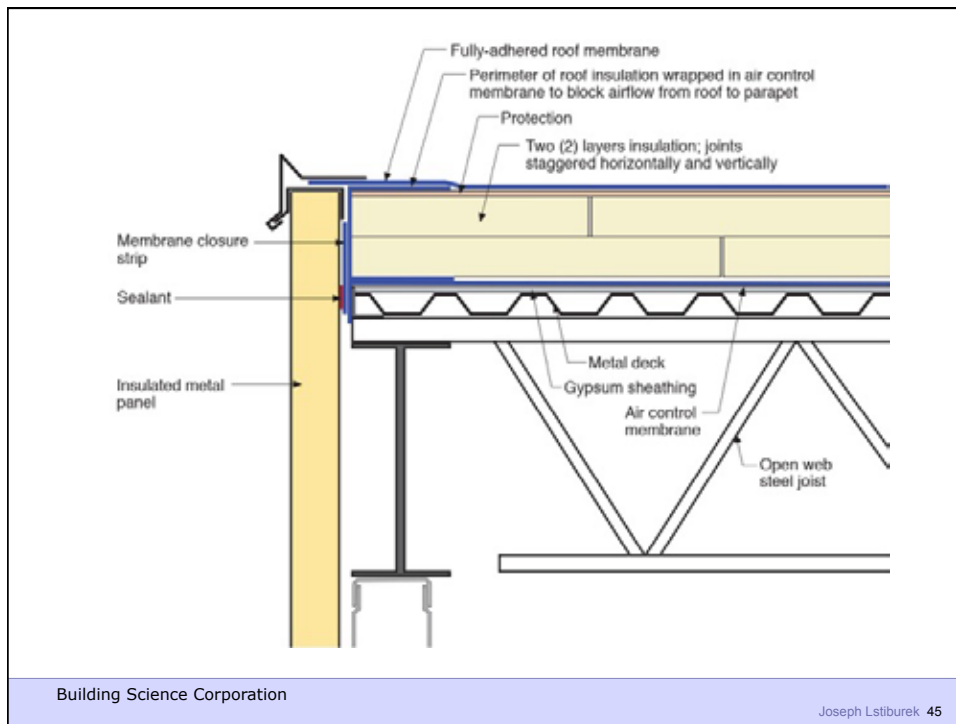

It's a Case of Black or White

It's a Case of Black or White Arrhenius

Building Science Corporation

Joseph Lstiburek 47

It's a Case of Black or White
Arrhenius
Every 10 degrees C – double the “badness”

Building Science Corporation

Joseph Lstiburek 48

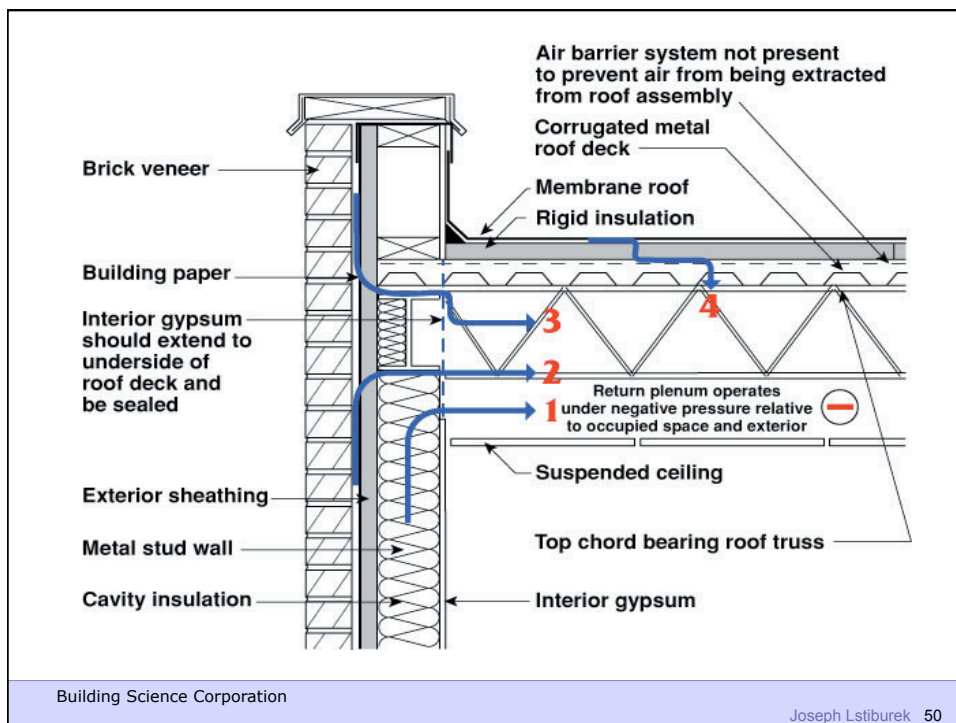
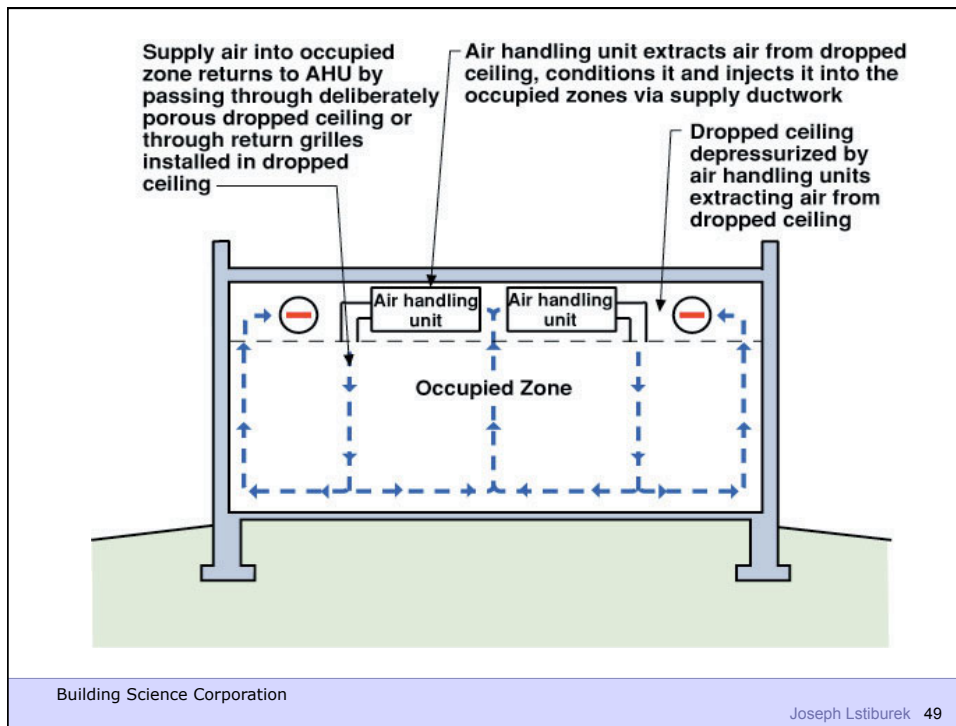

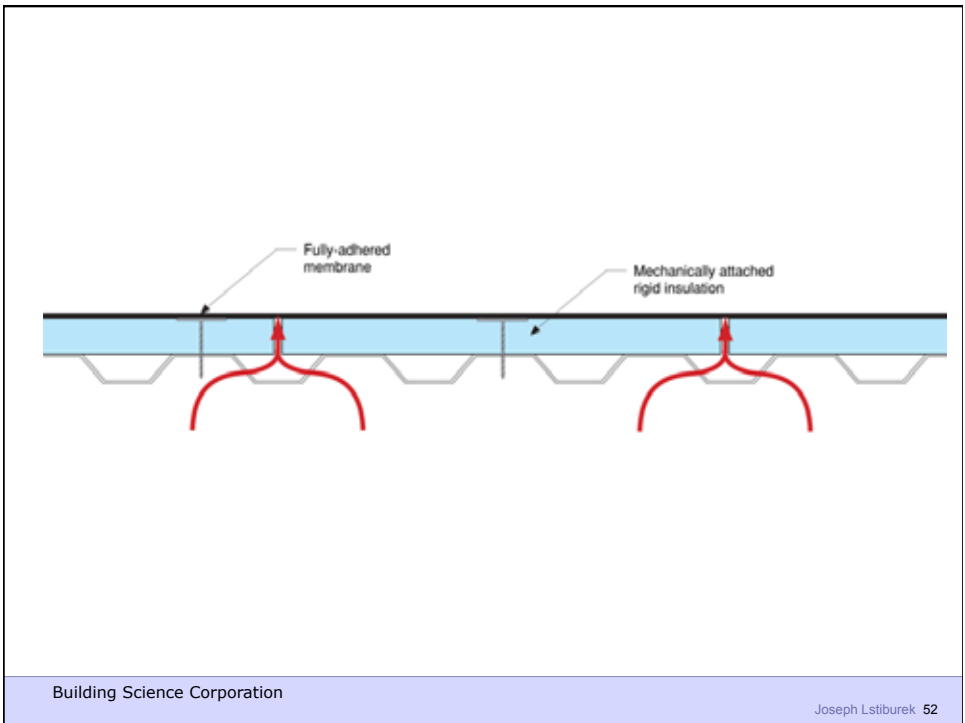
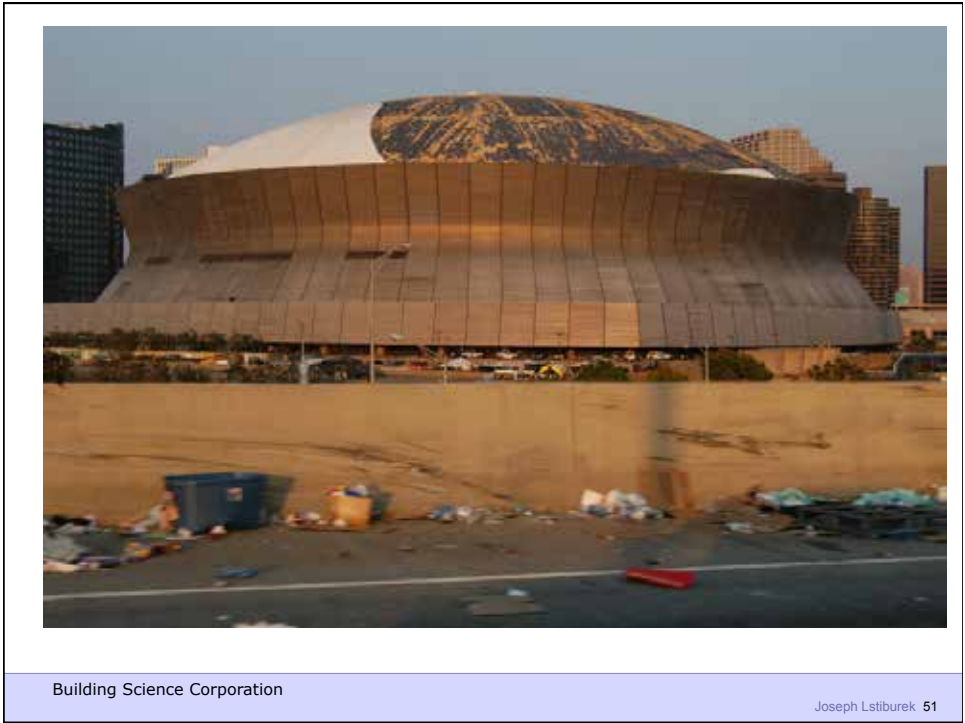



Building Science Corporation

Joseph Lstiburek 53

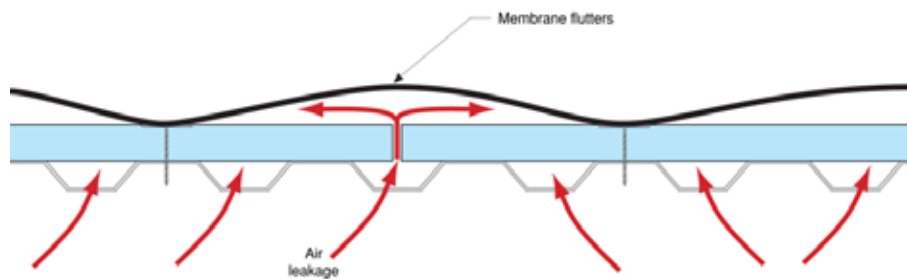

Building Science Corporation

Joseph Lstiburek 54





Building Science Corporation

Joseph Lstiburek 57



Building Science Corporation

Joseph Lstiburek 58

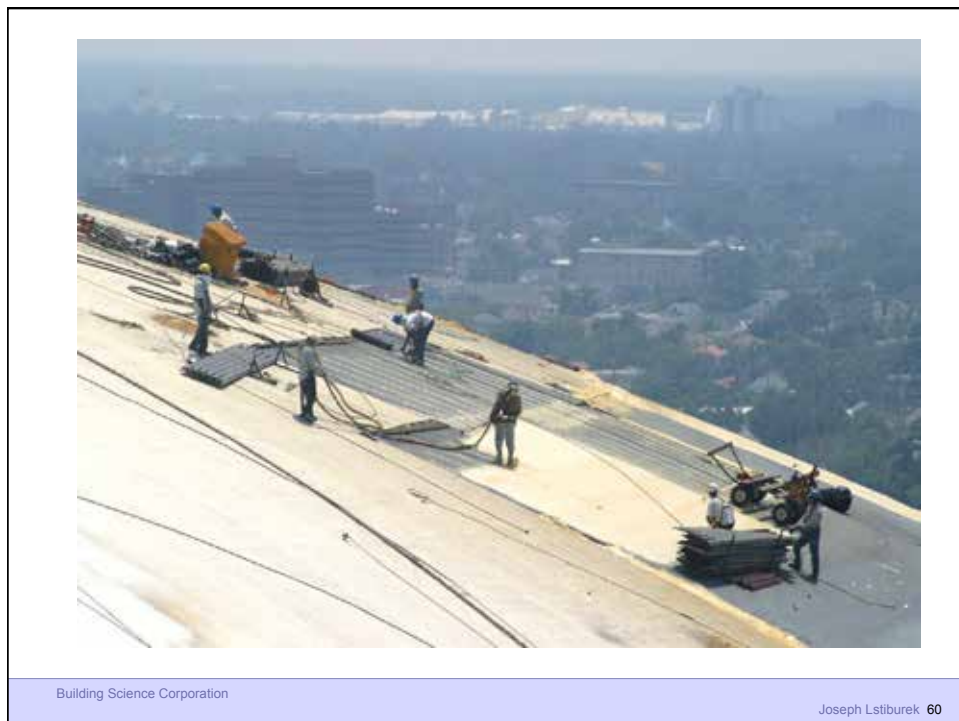
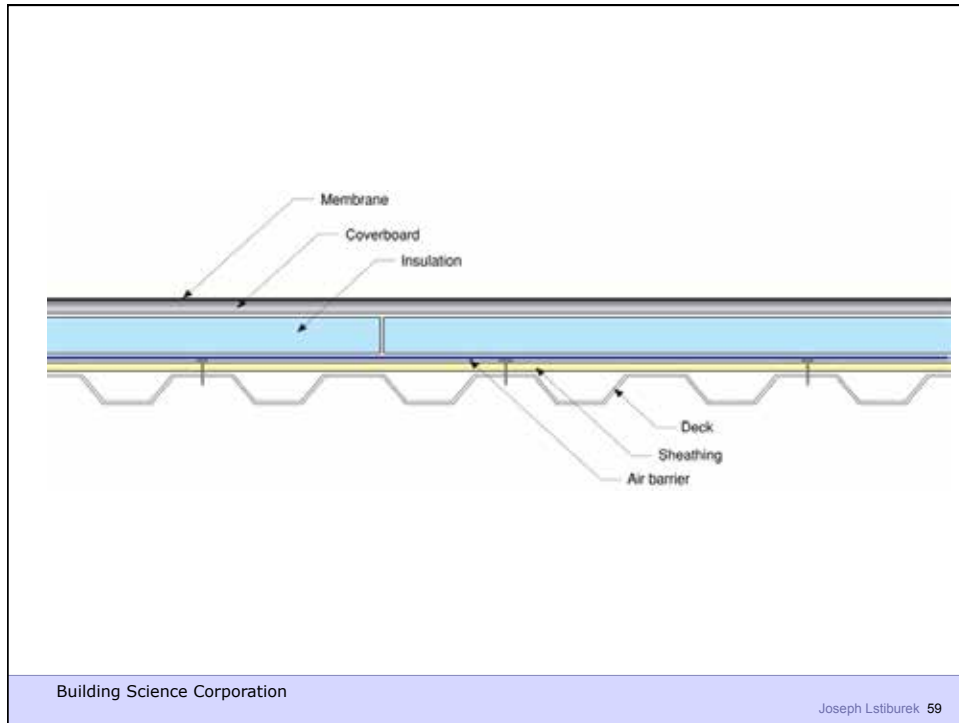

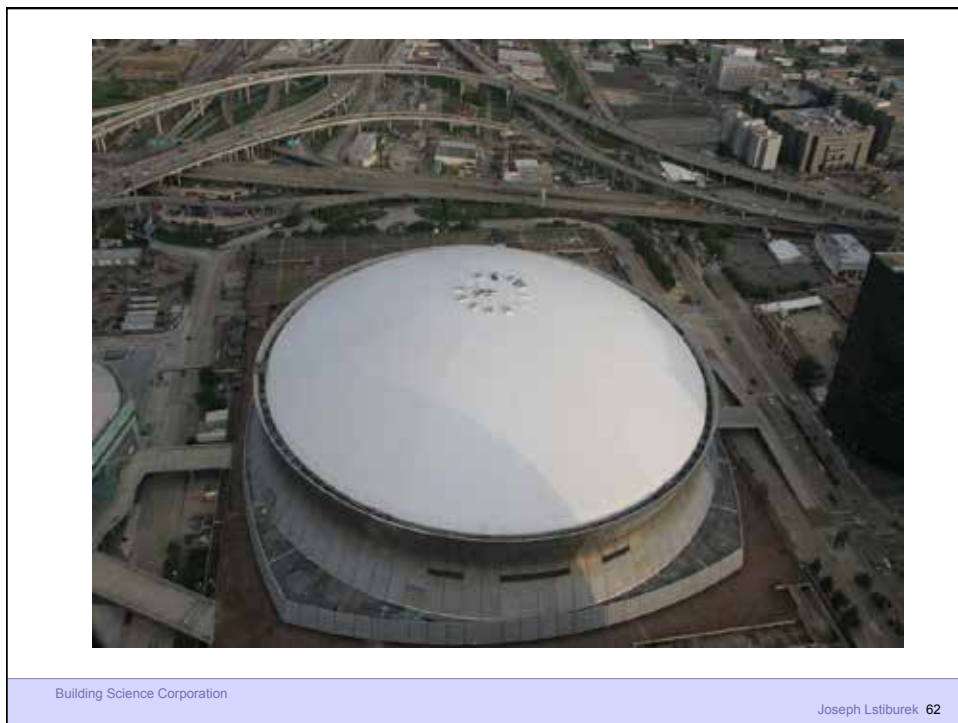
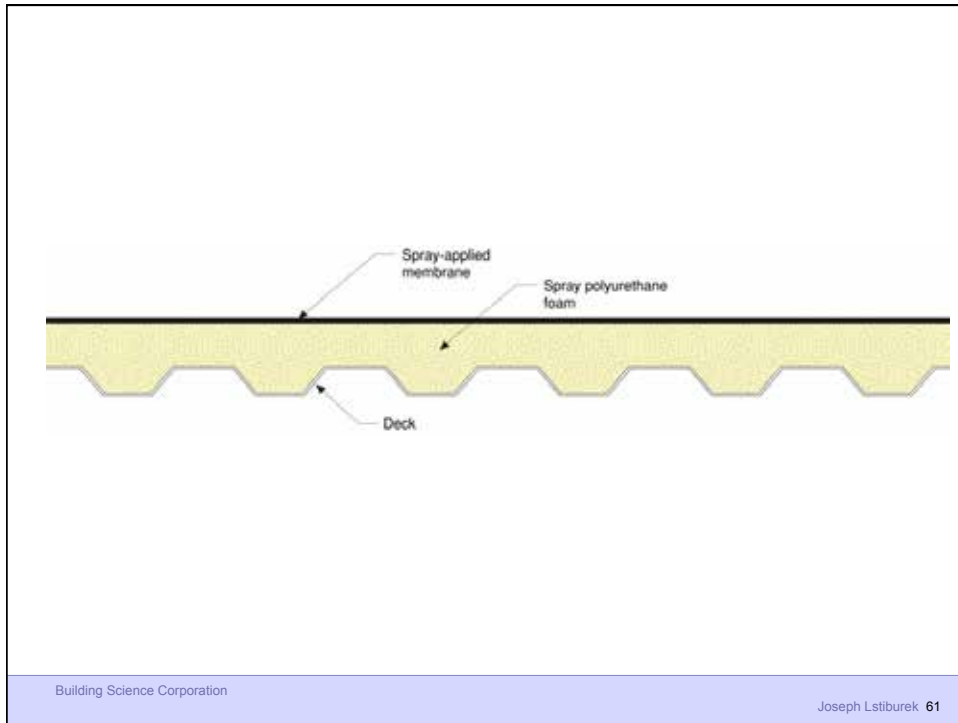

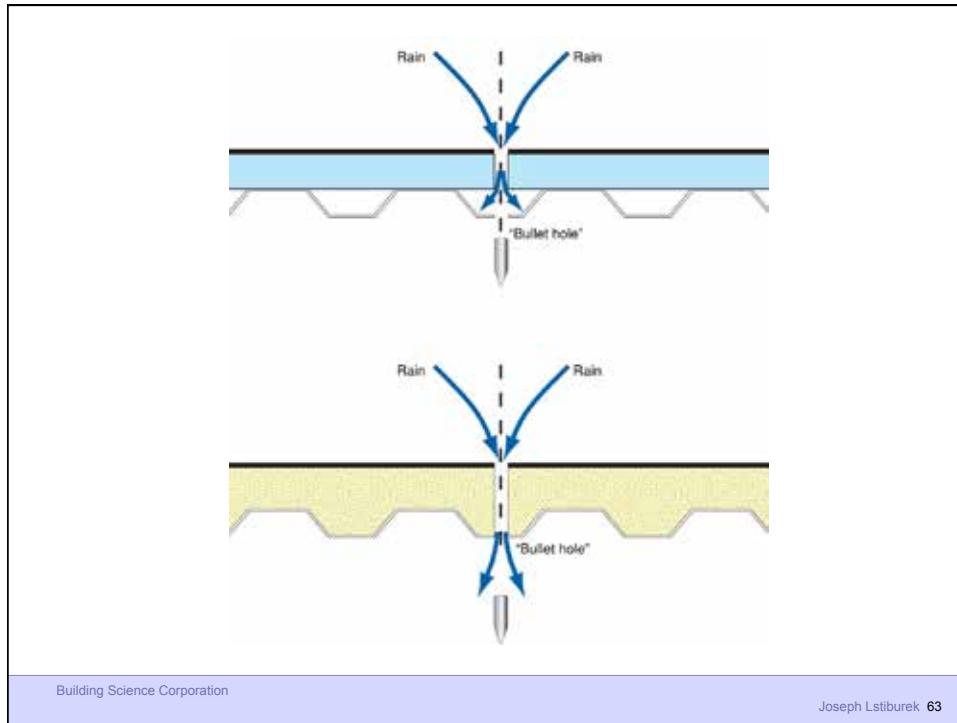



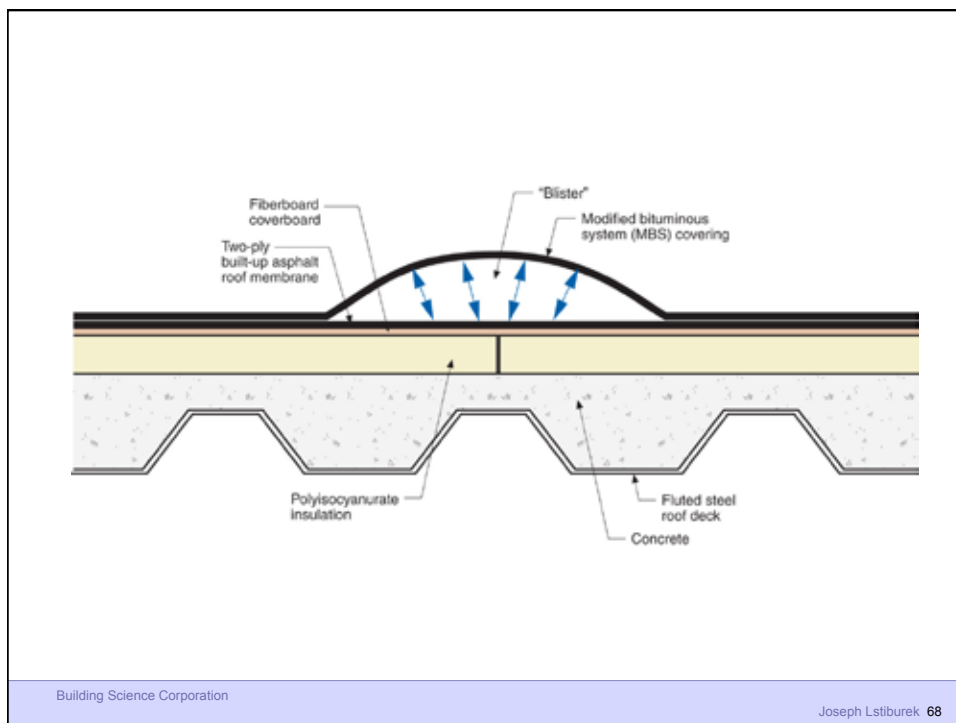
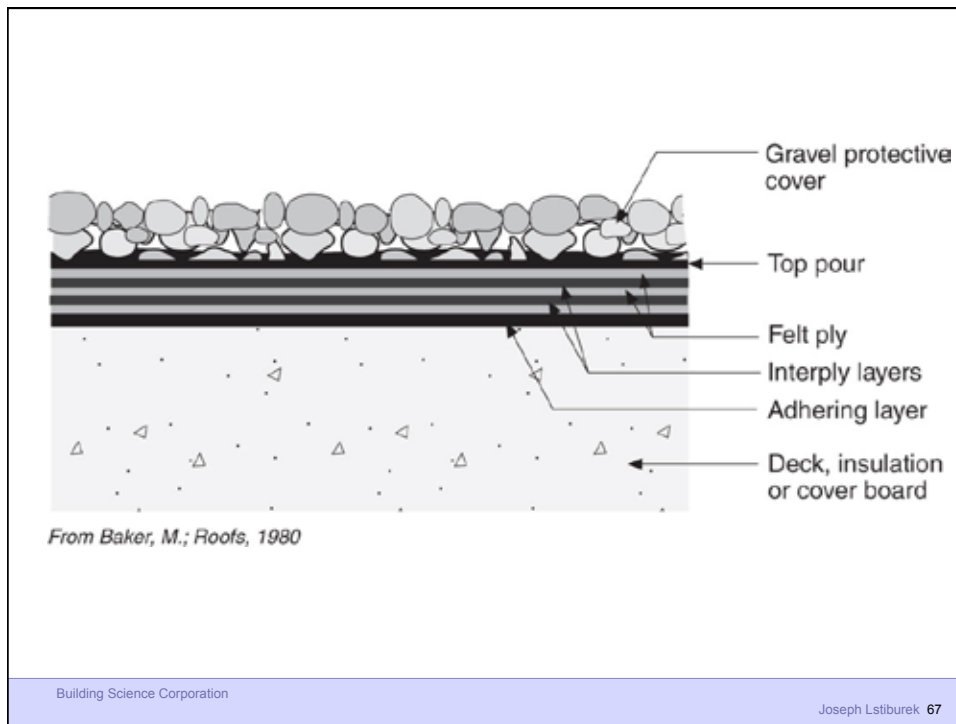

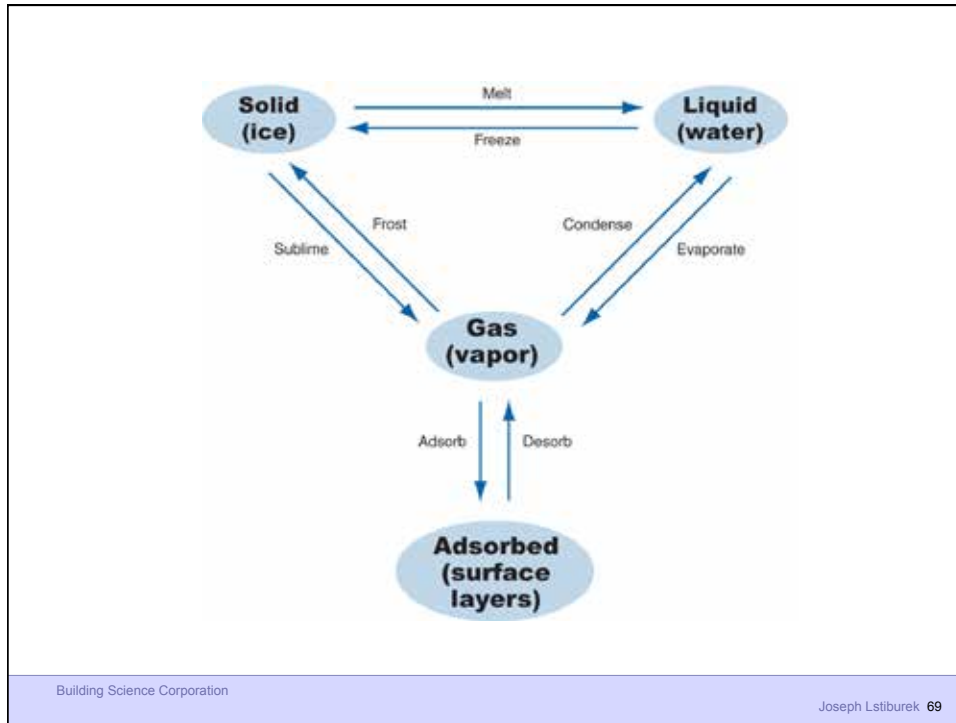

Moisture Transport in Porous Media

Phase	Transport Process	Driving Potential
Vapor	Diffusion	Vapor Concentration
Adsorbate	Surface Diffusion	Concentration
Liquid	Capillary Flow Osmosis	Suction Pressure Solute Concentration

Building Science Corporation Joseph Lstiburek 70

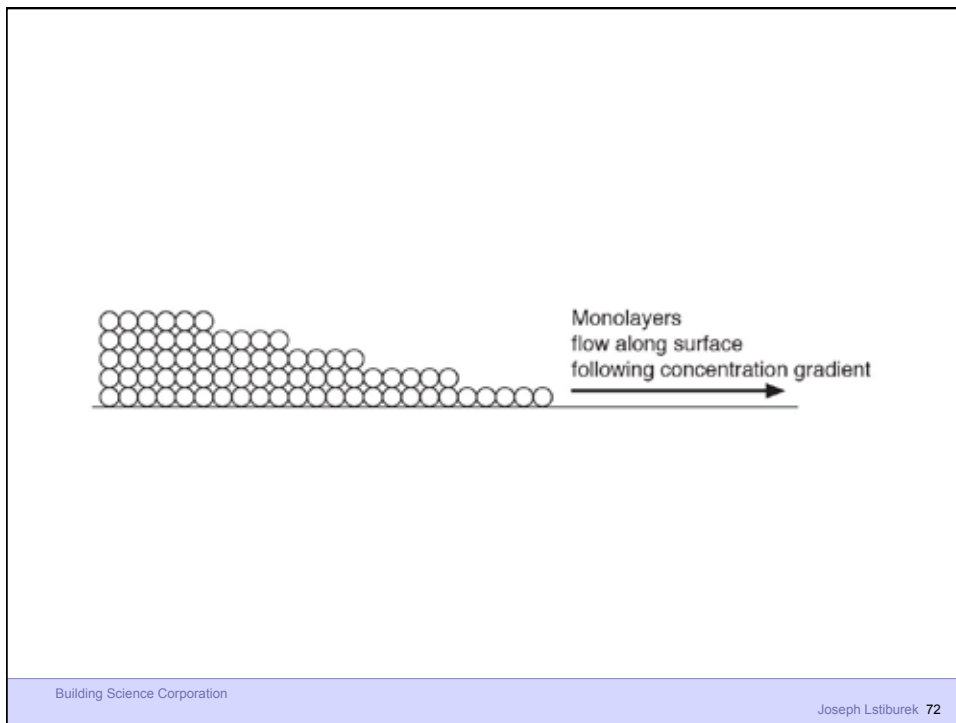
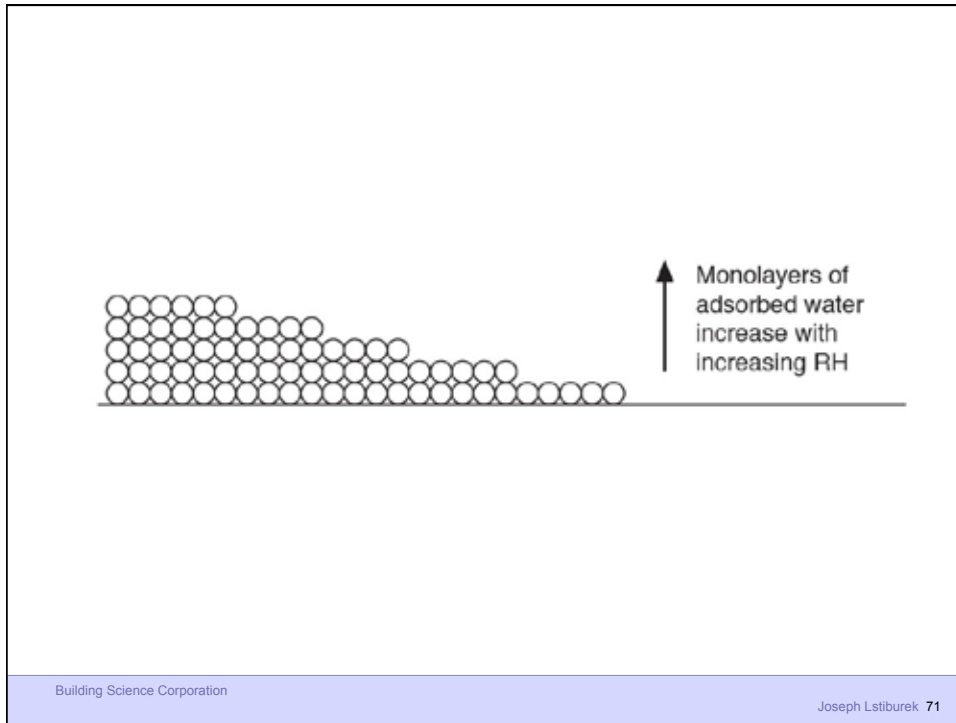

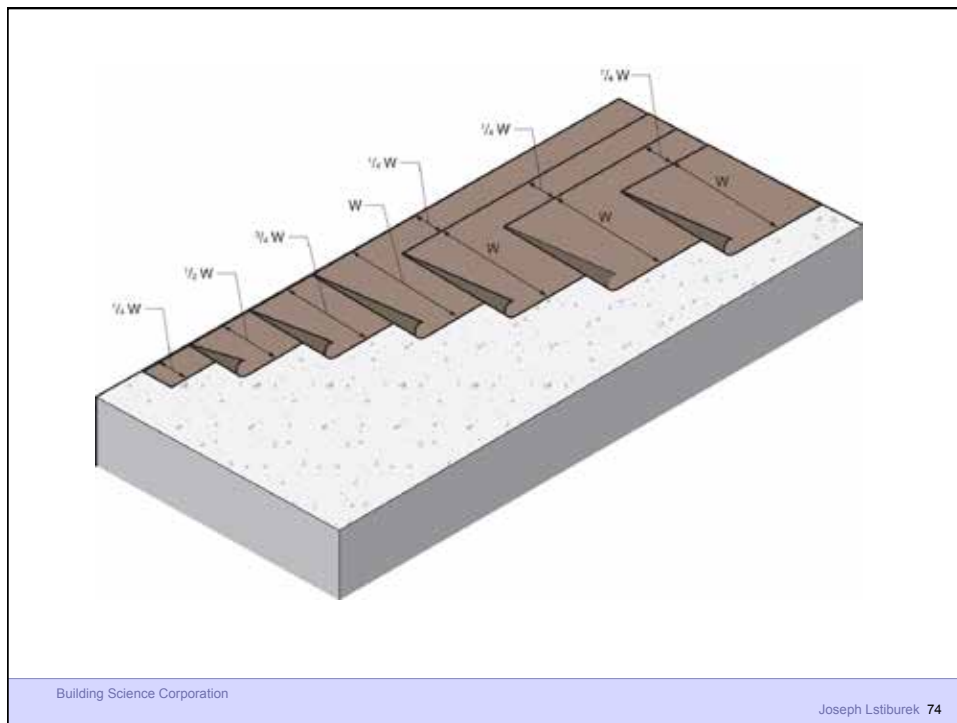
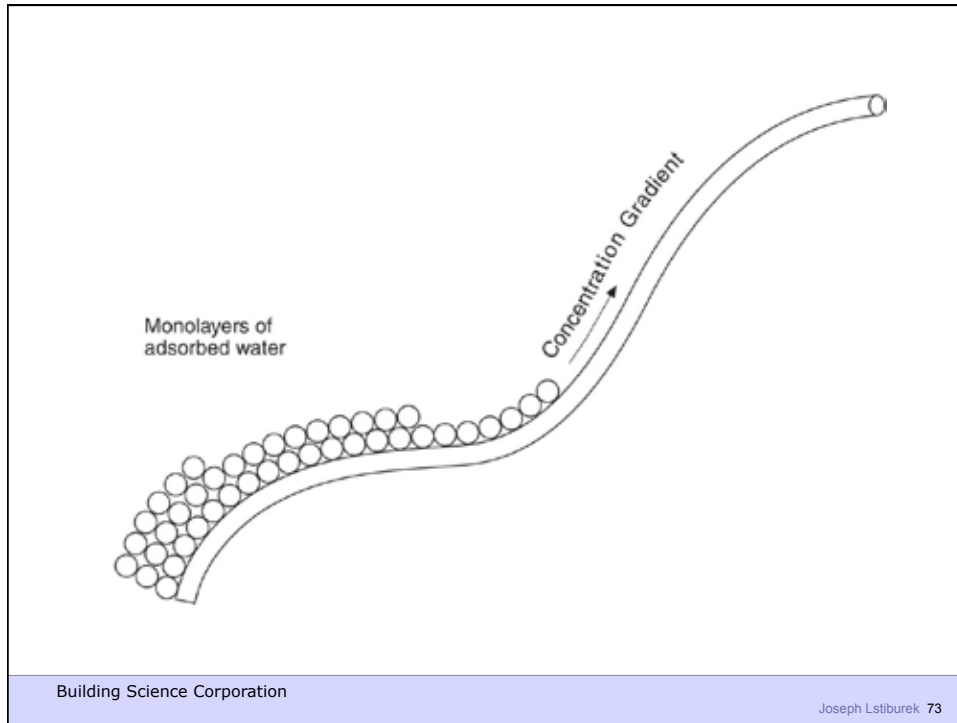

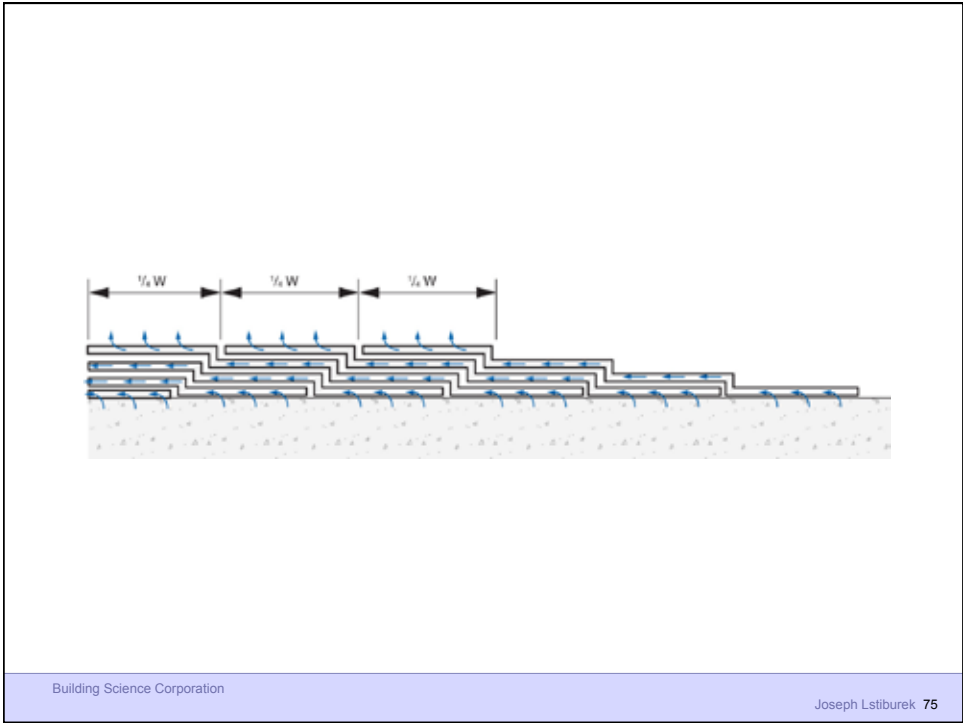



Building Science Corporation

Joseph Lstiburek 77



Building Science Corporation

Joseph Lstiburek 78

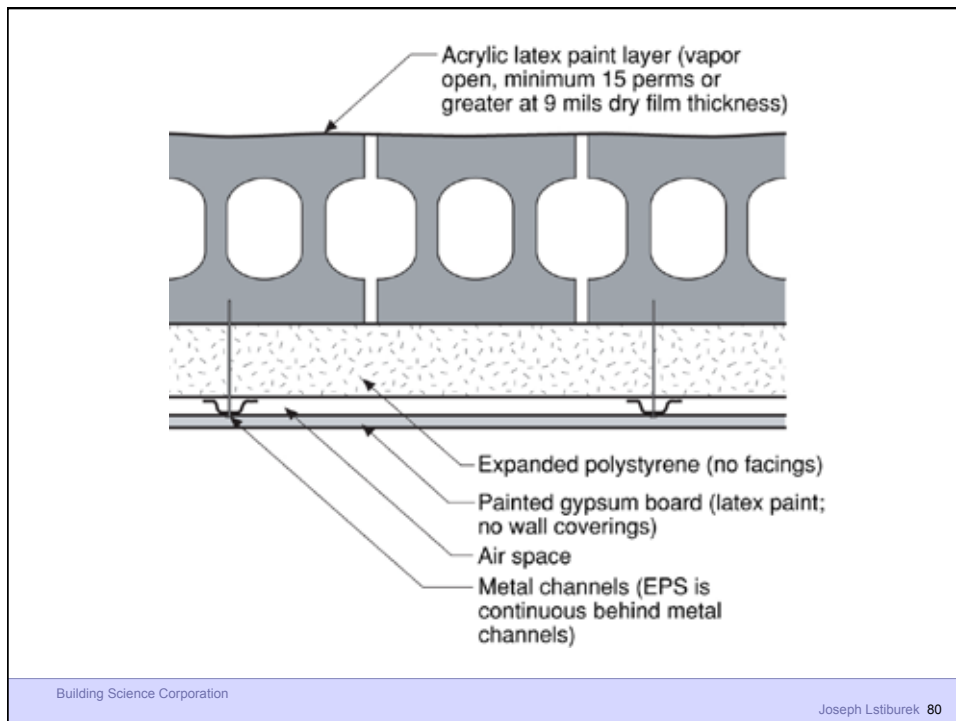
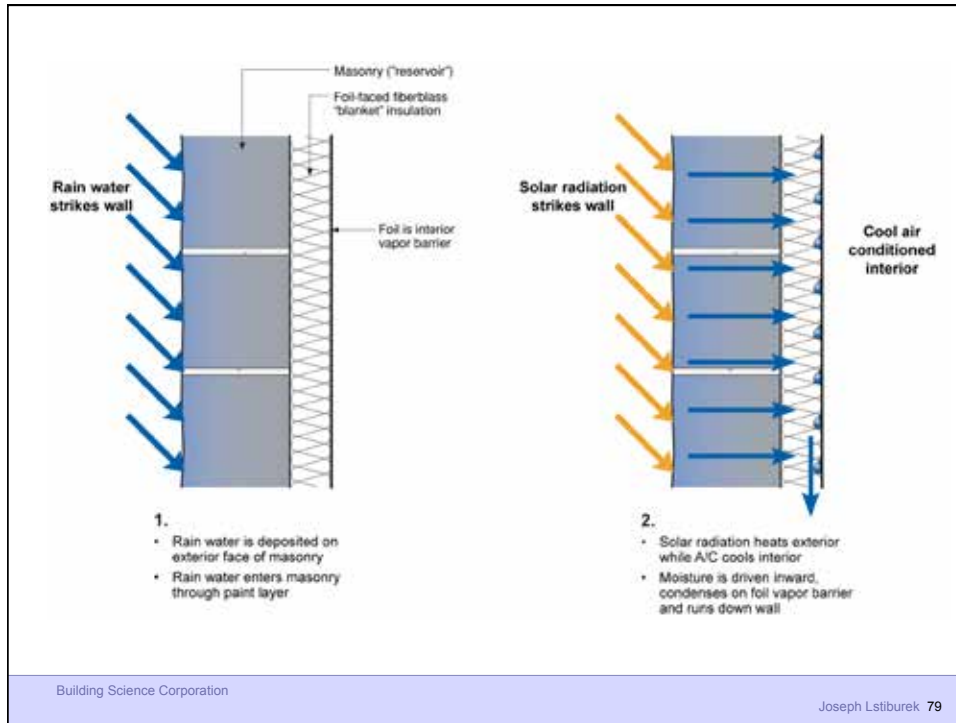

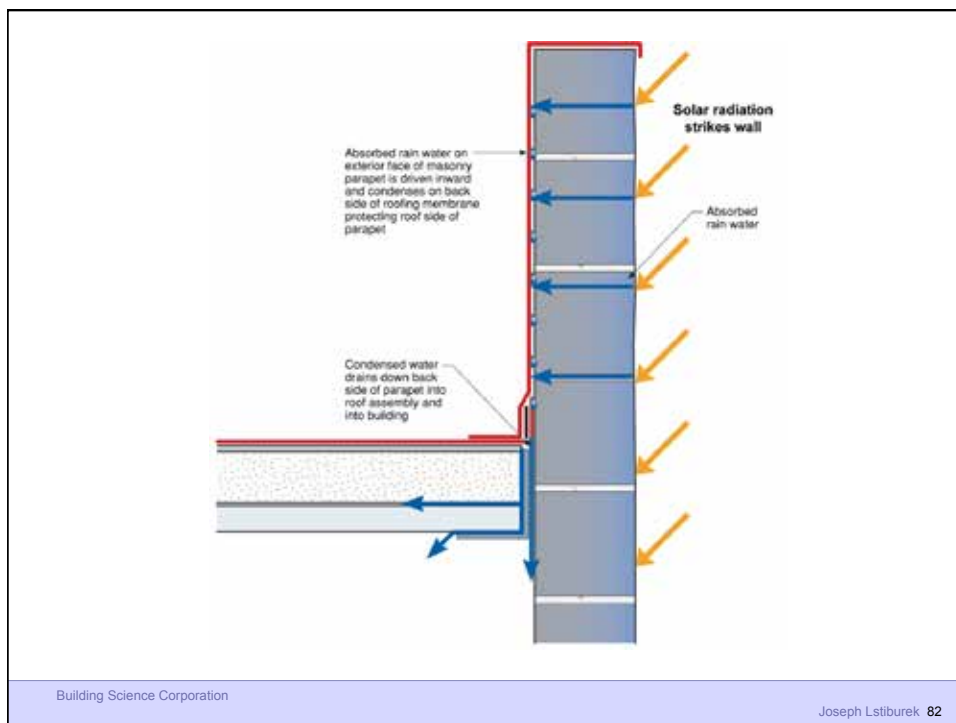
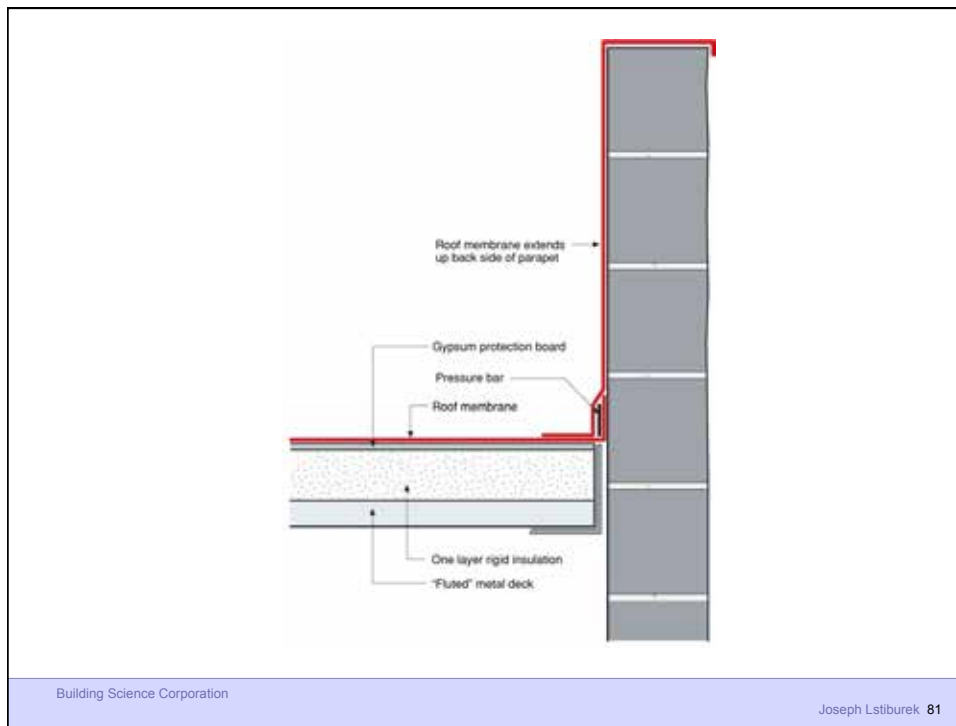

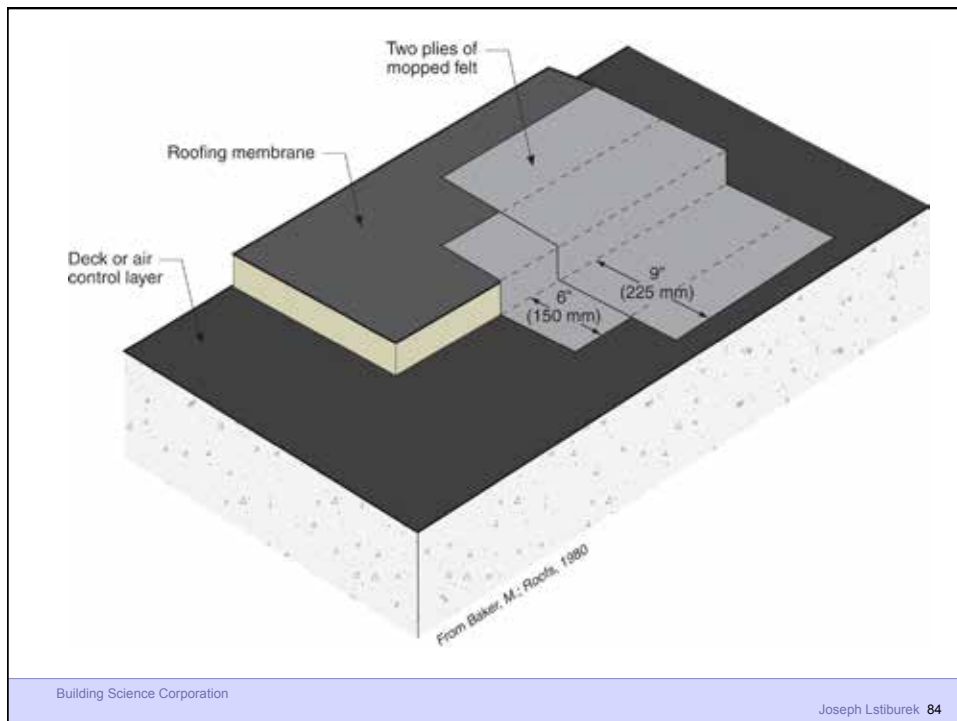
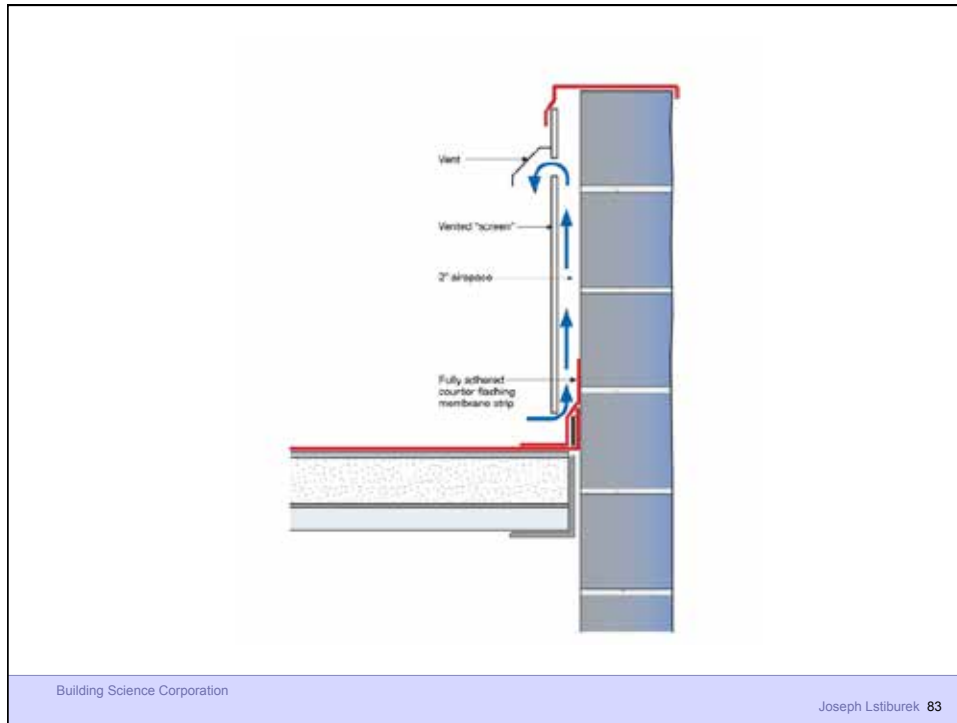

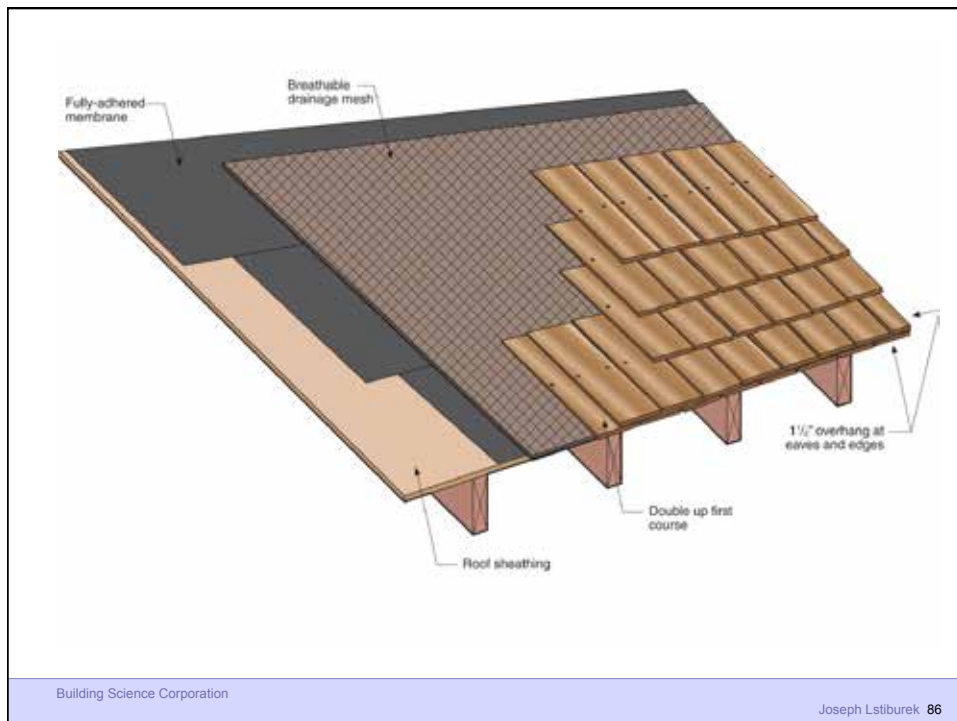
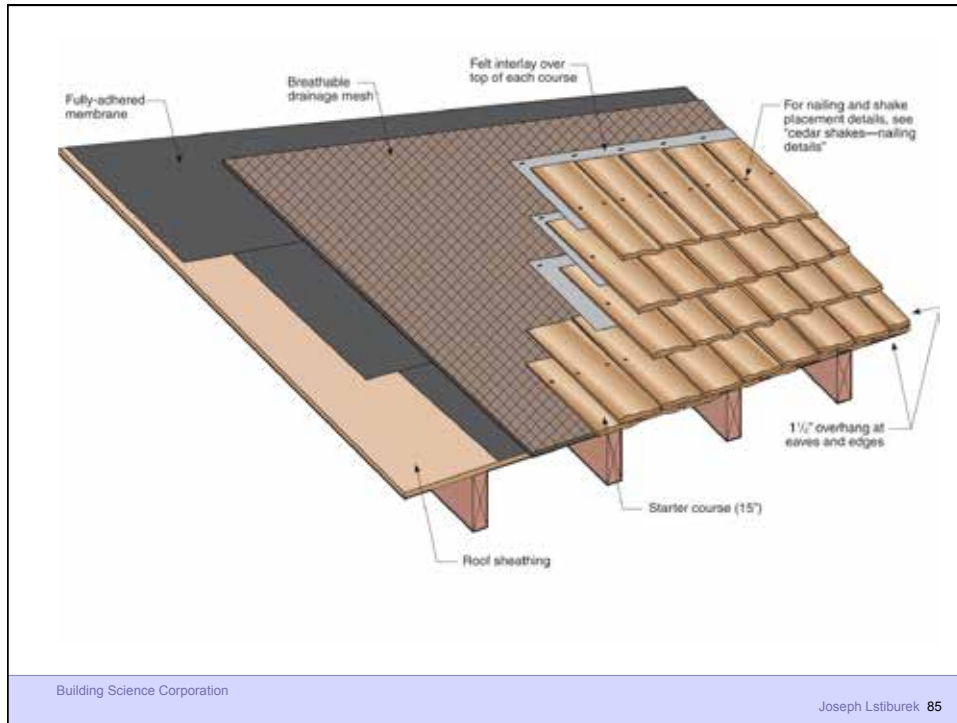

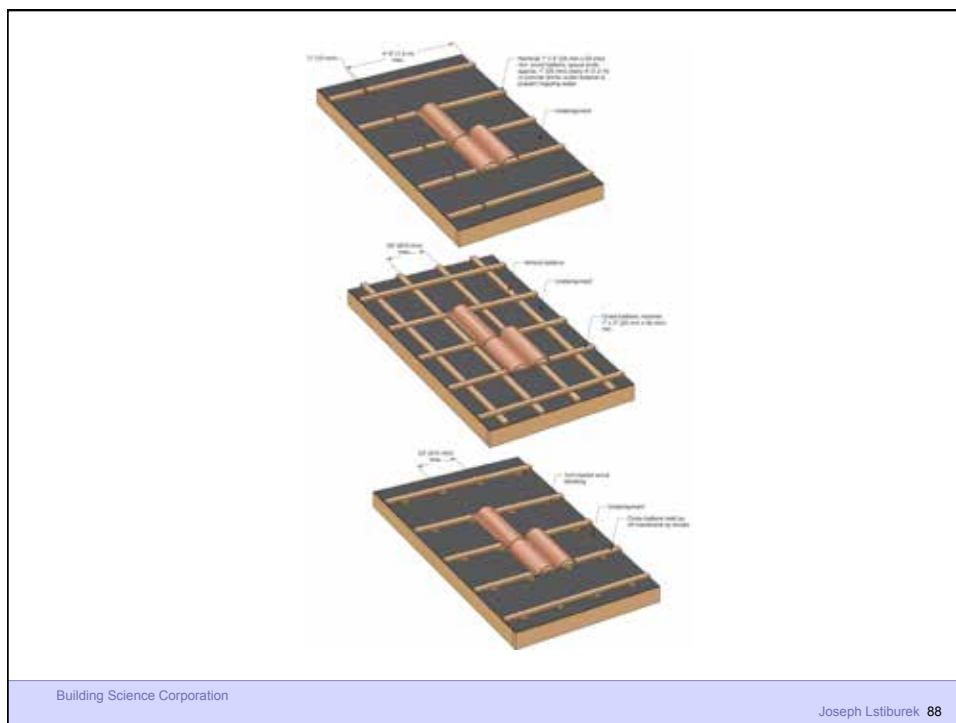
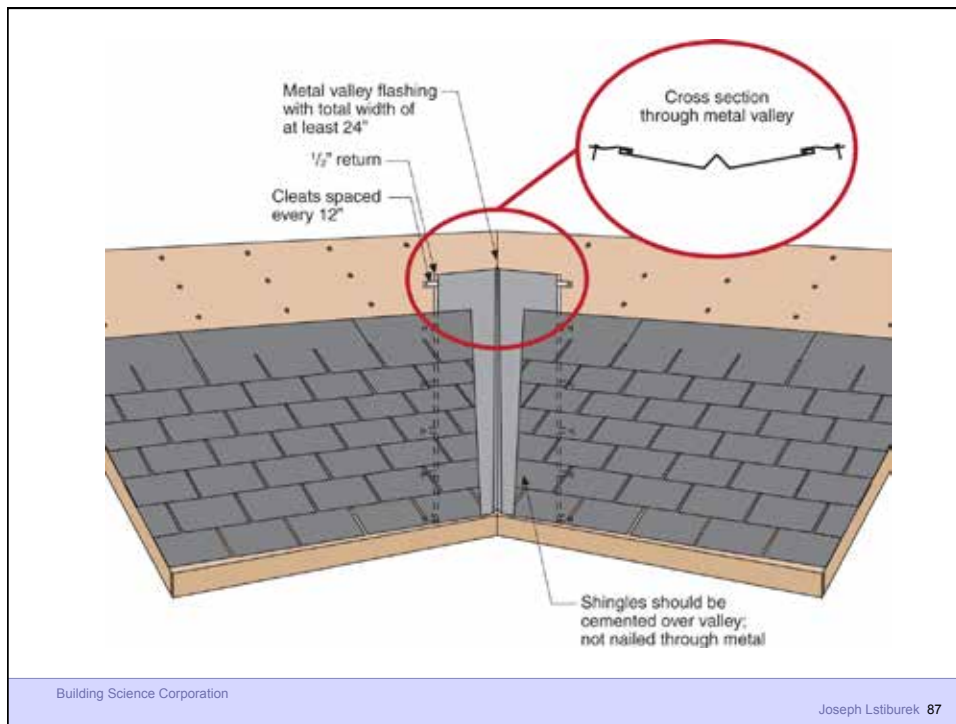

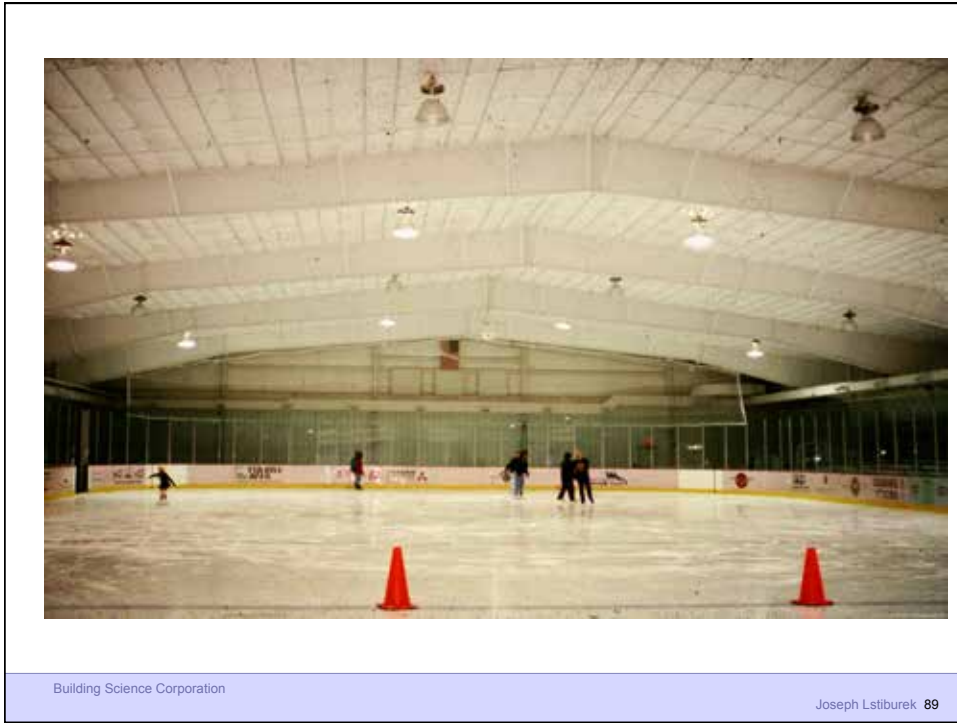

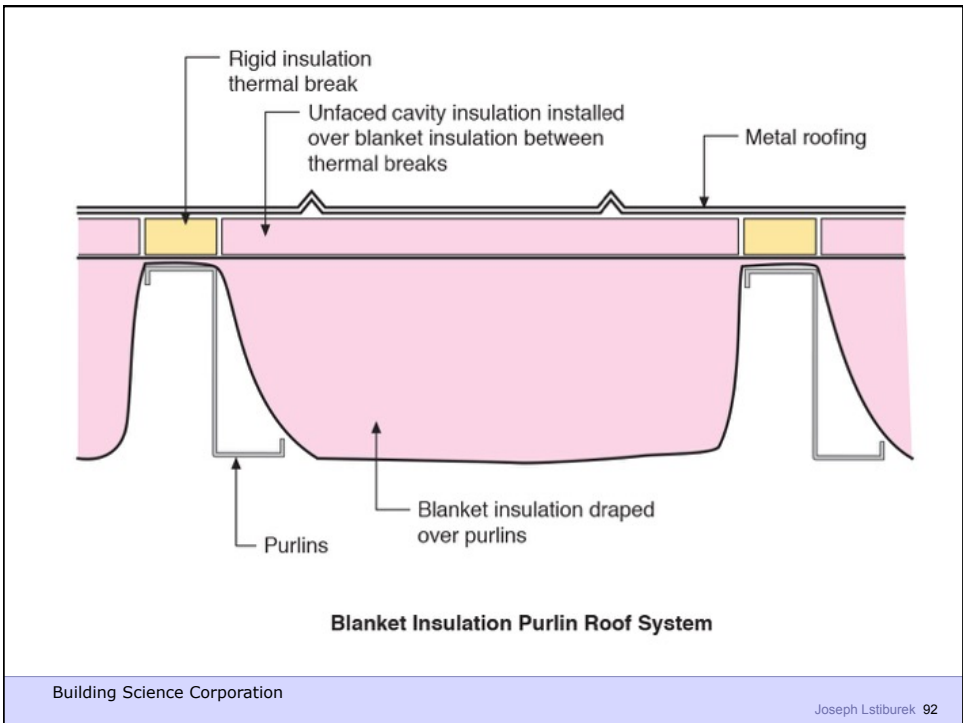





Building Science Corporation

Joseph Lstiburek 95



Building Science Corporation

Joseph Lstiburek 96

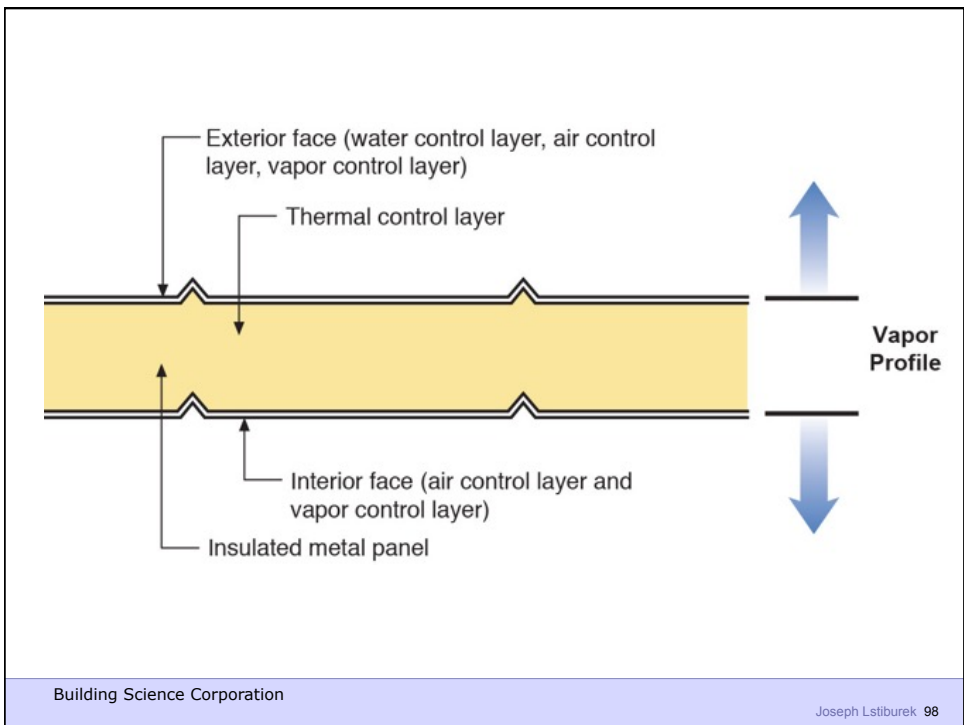

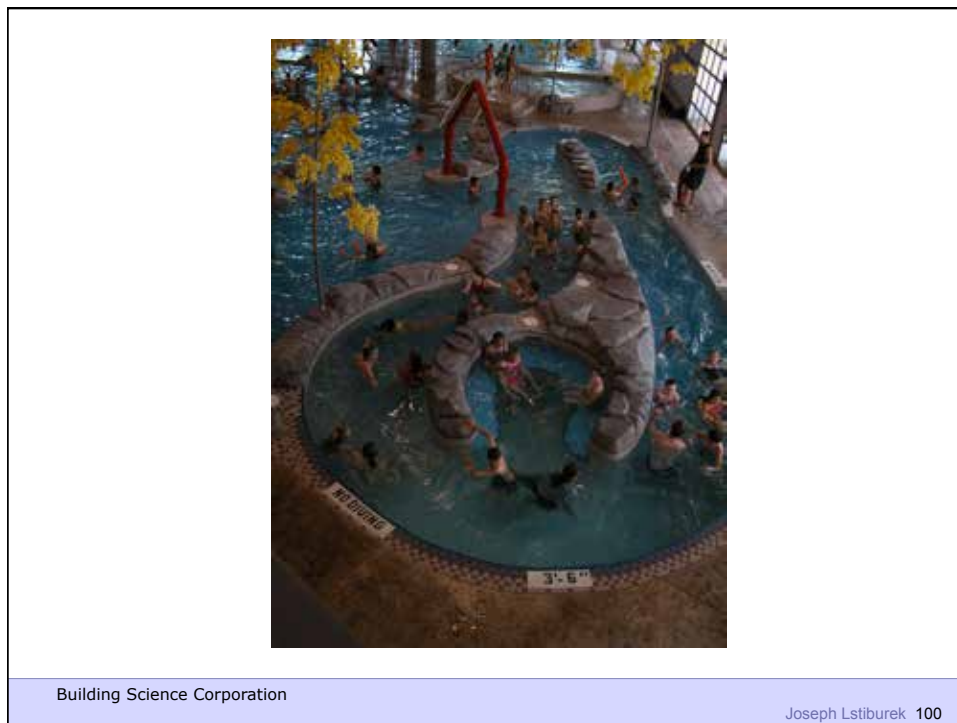
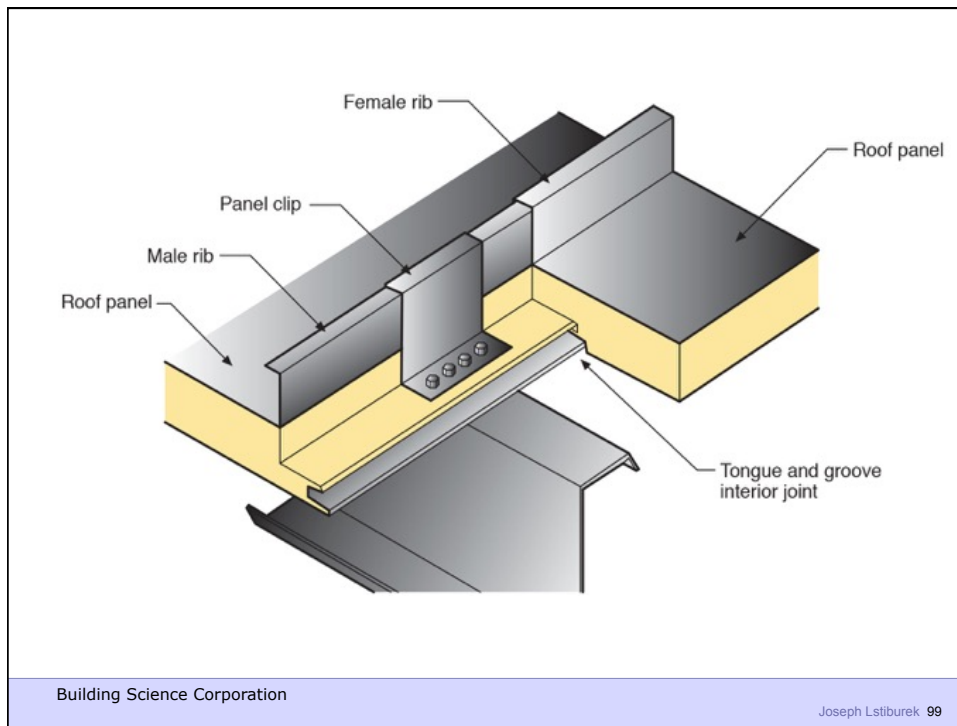

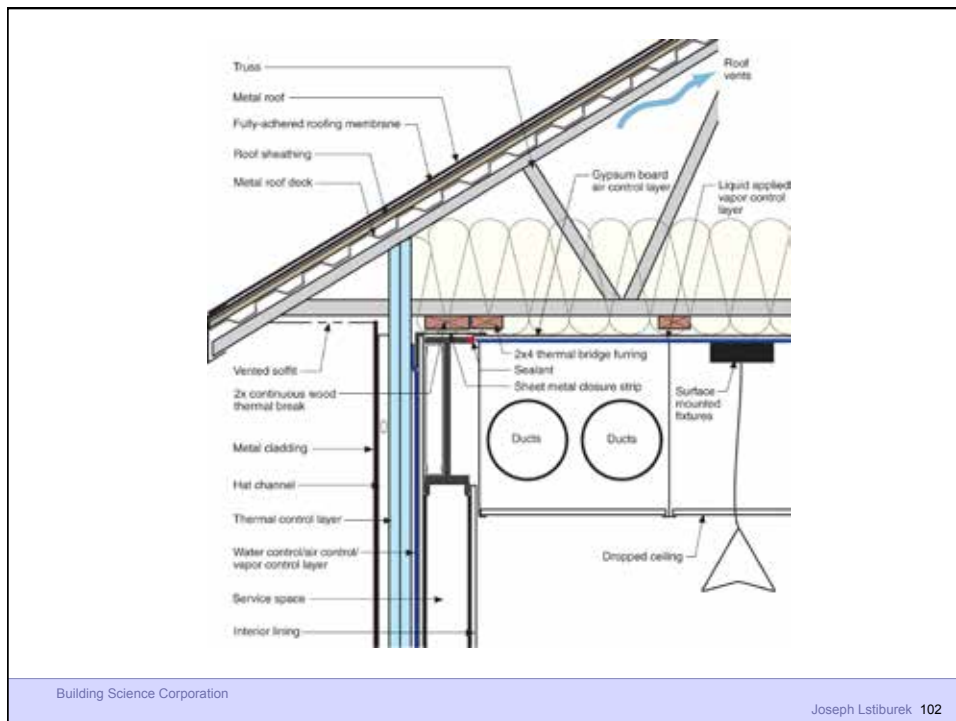
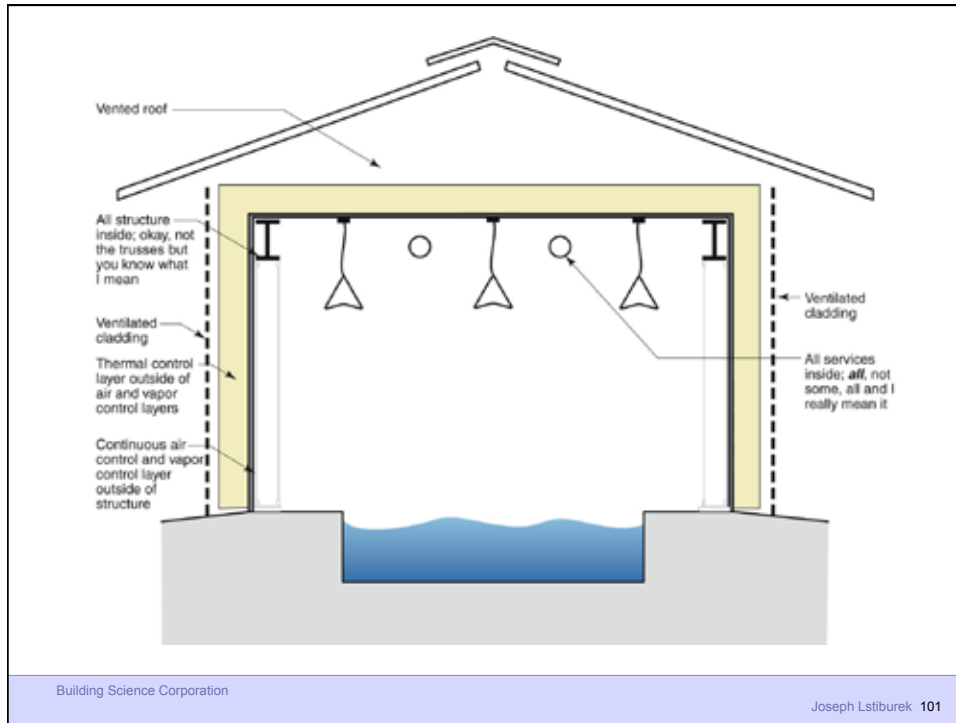

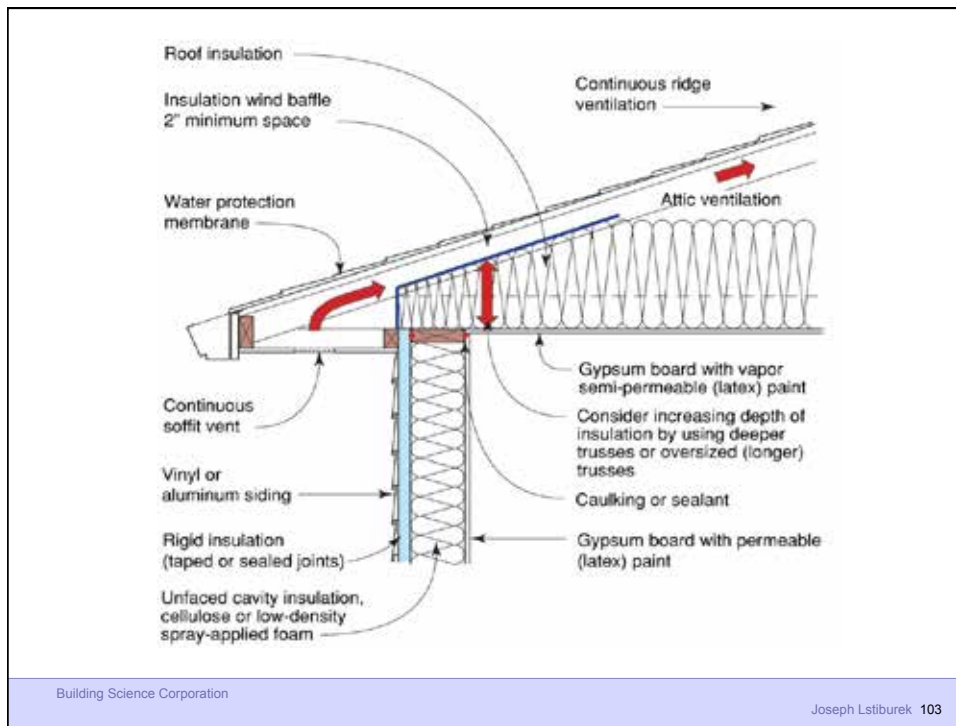

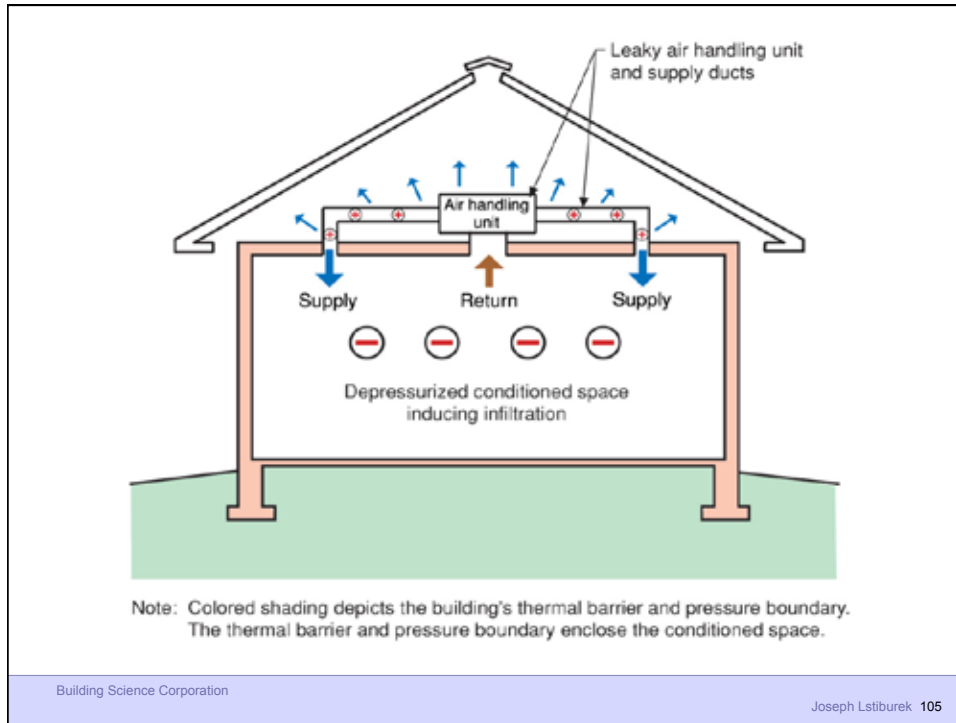



Building Science Corporation

Joseph Lstiburek 107



Building Science Corporation

Joseph Lstiburek 108



Building Science Corporation

Joseph Lstiburek 109



Building Science Corporation

Joseph Lstiburek 110

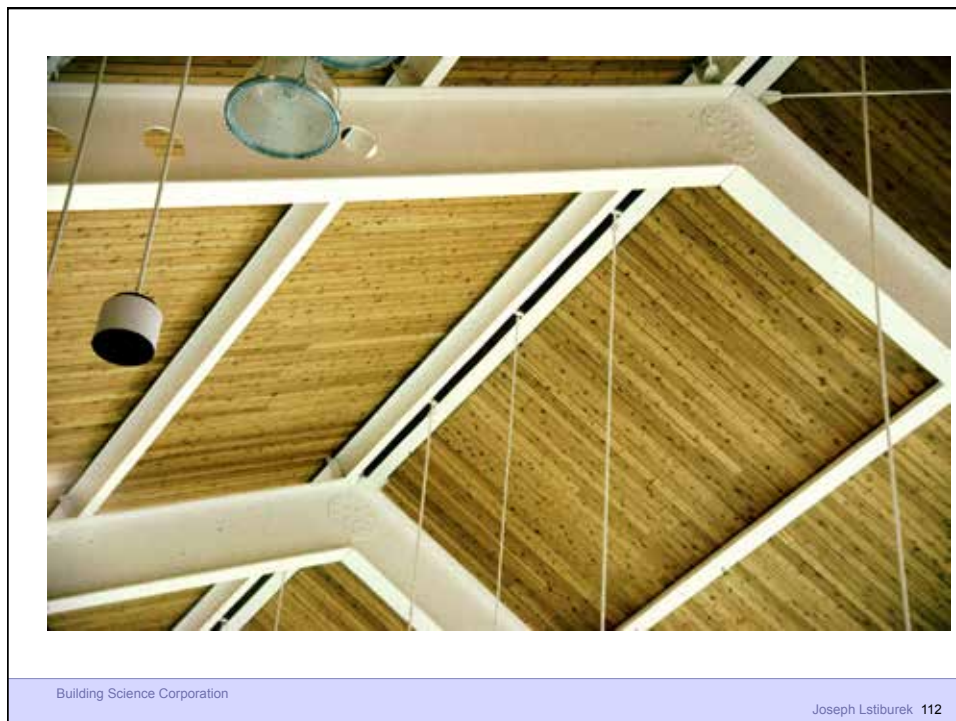
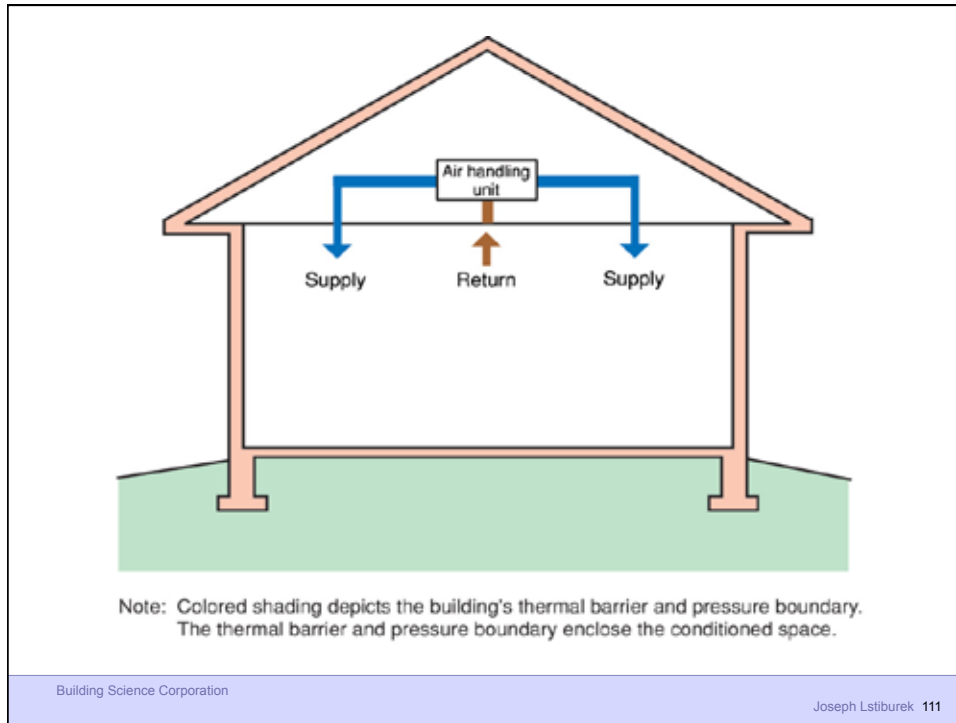

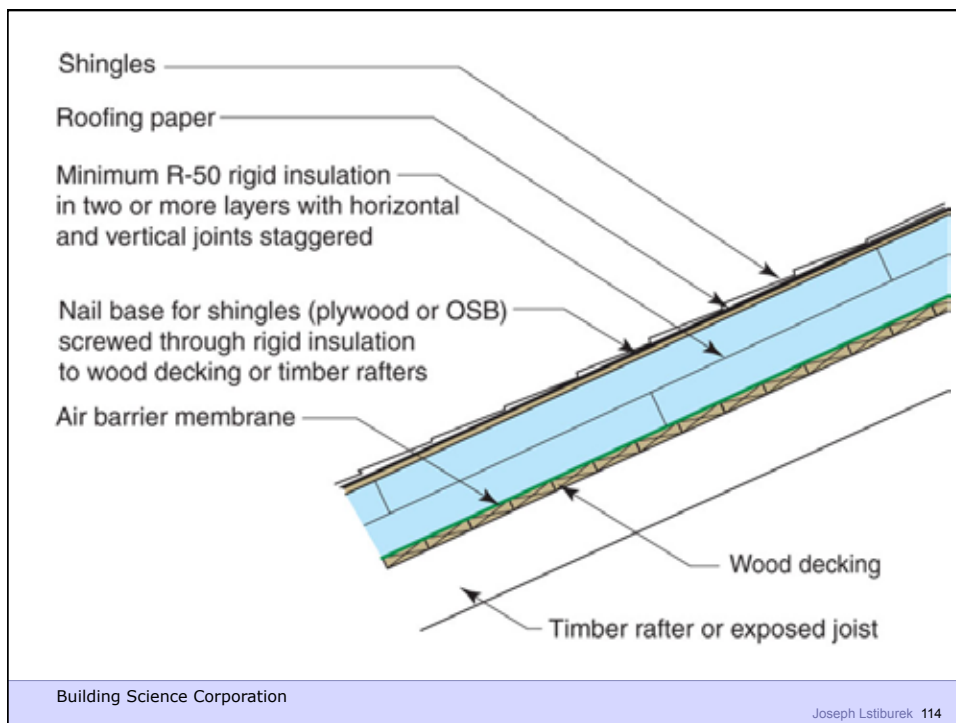
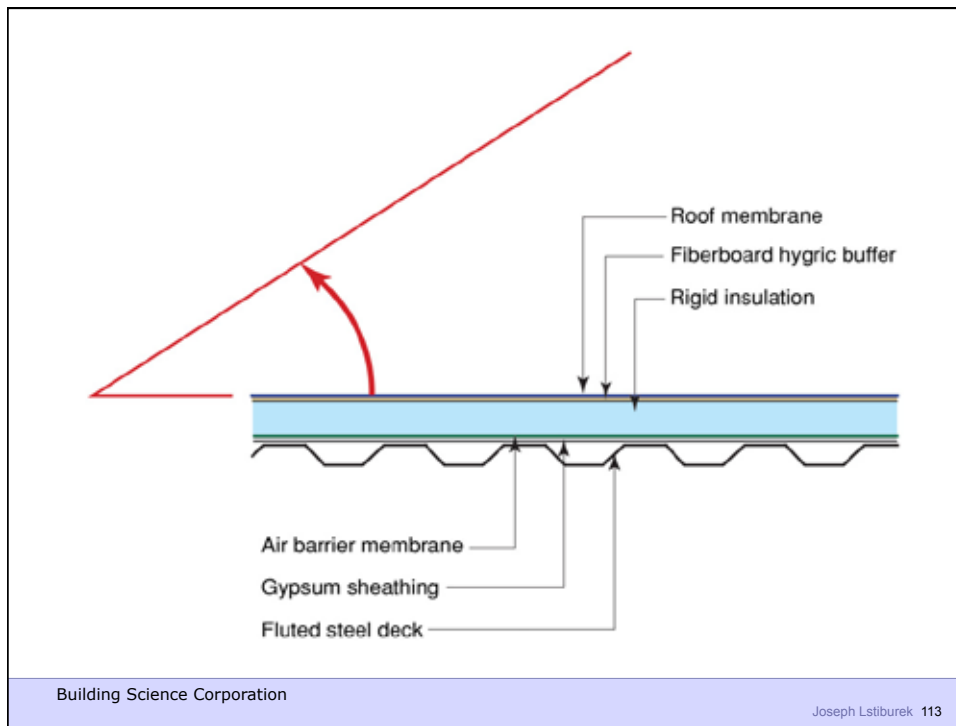

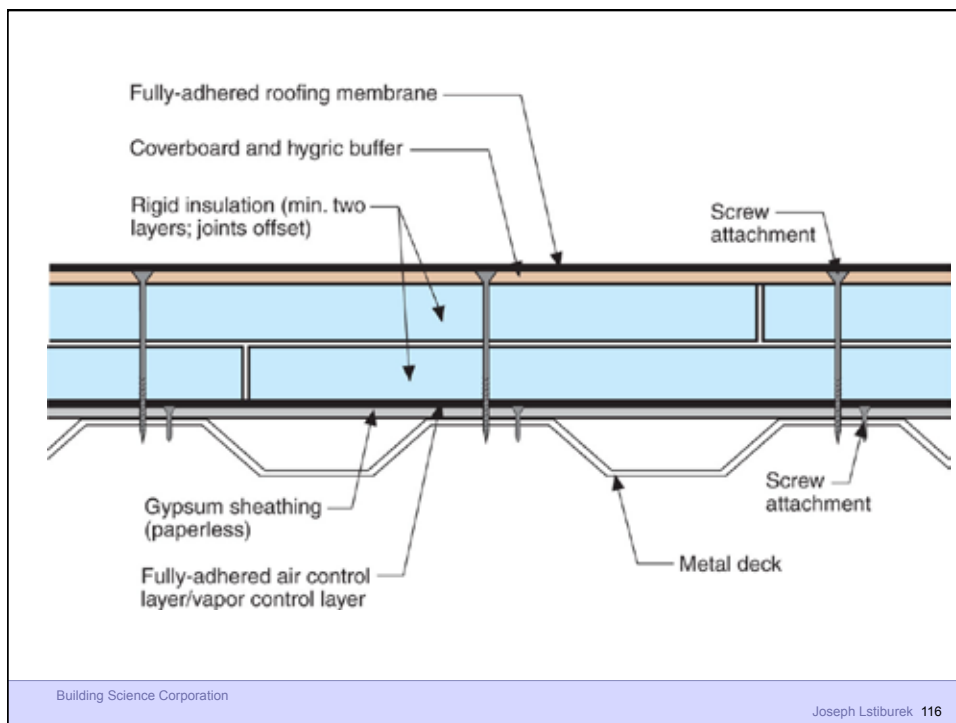
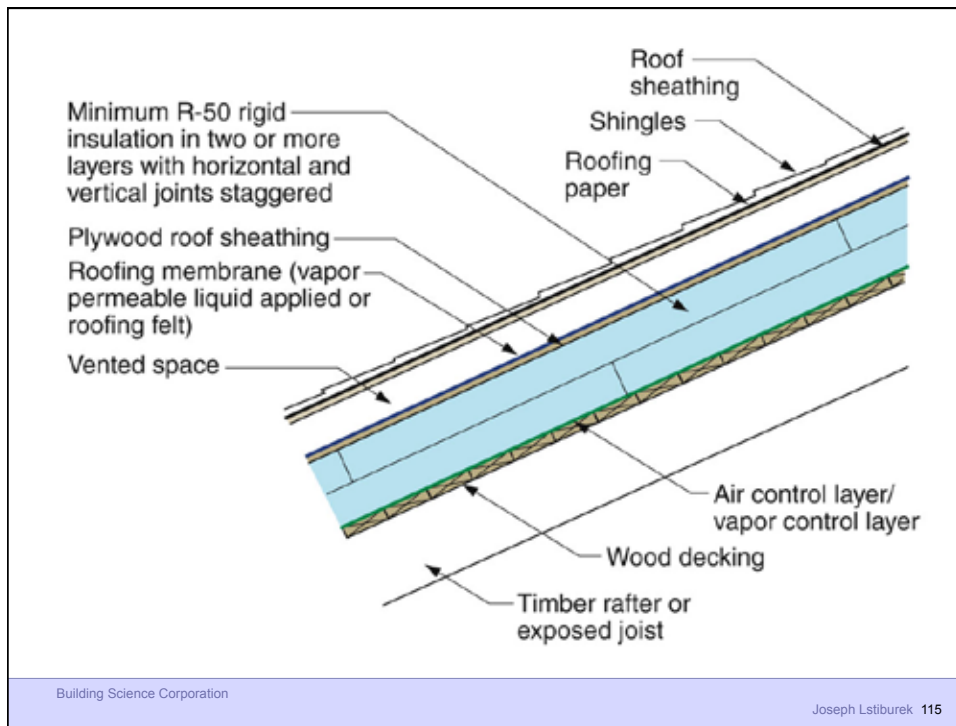

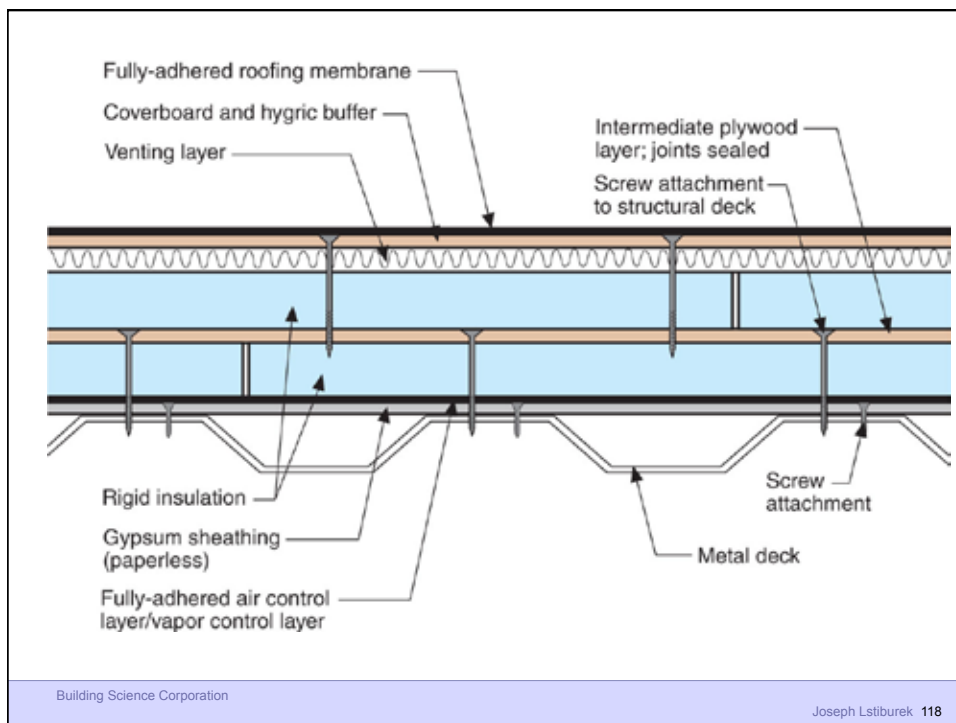
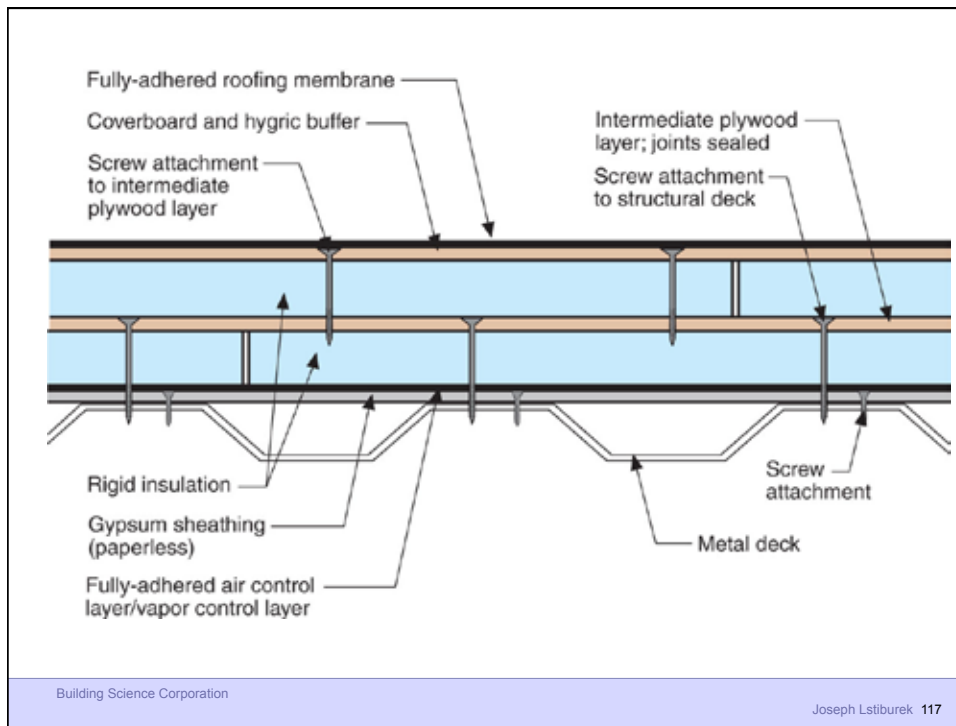



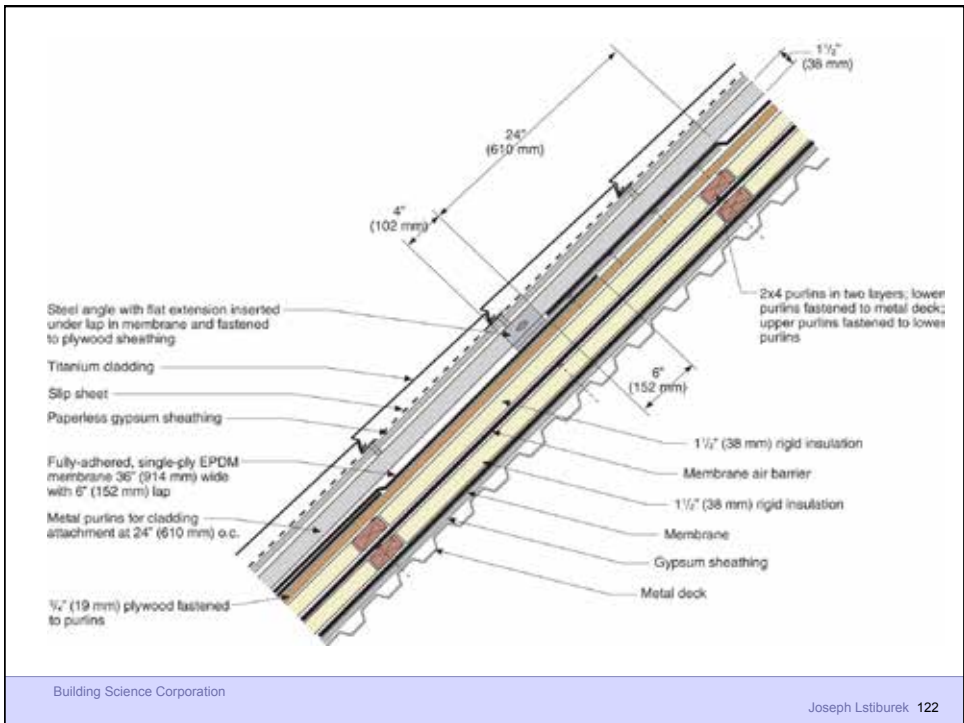

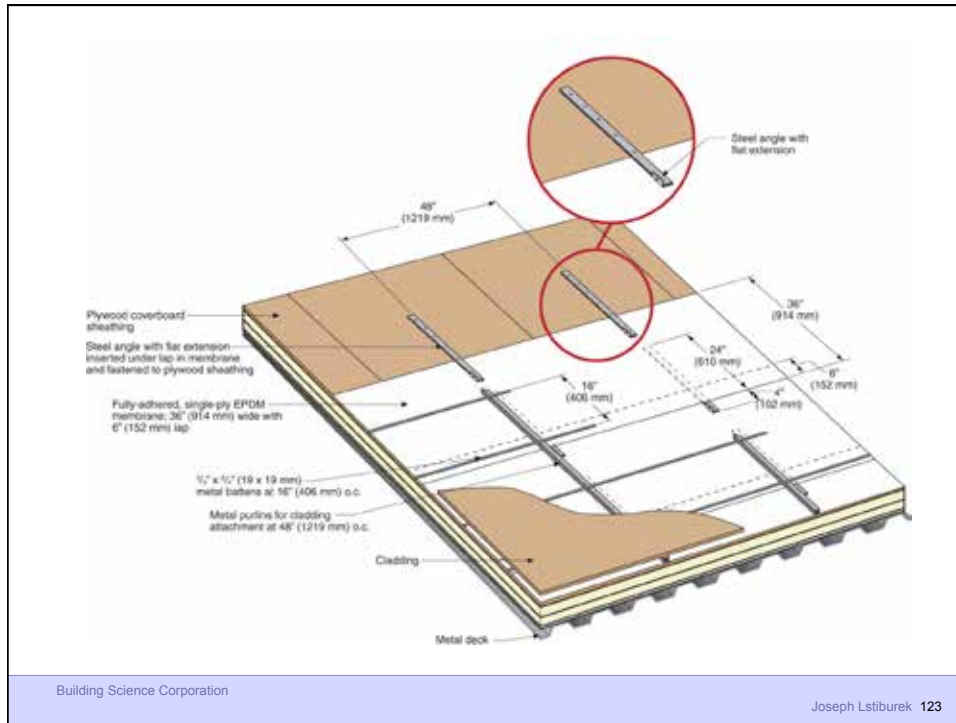

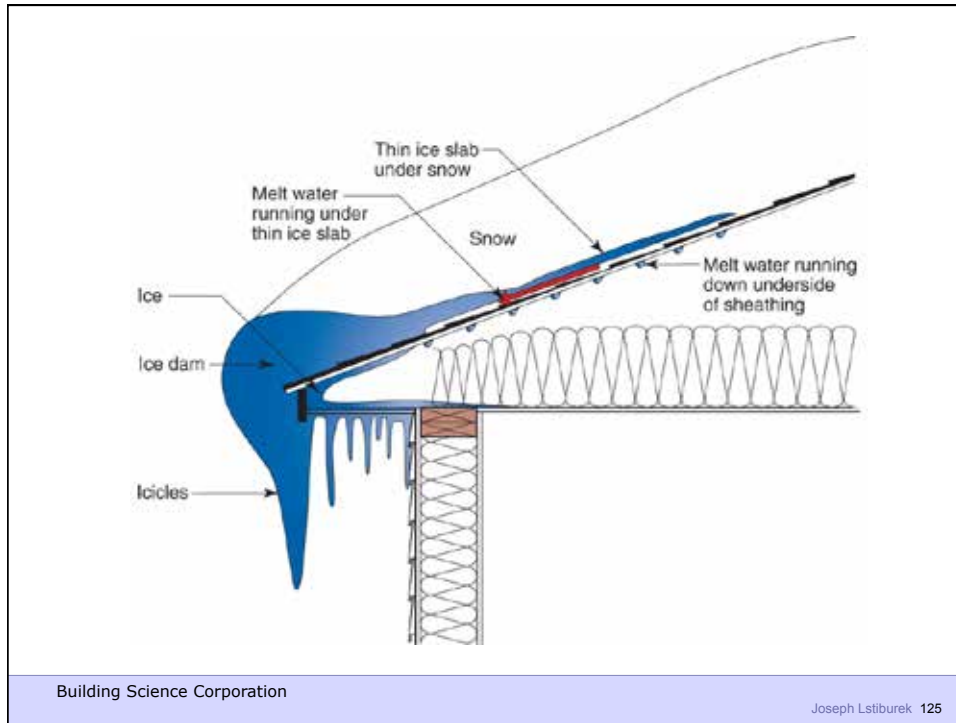



Building Science Corporation

Joseph Lstiburek 127



Building Science Corporation

Joseph Lstiburek 128

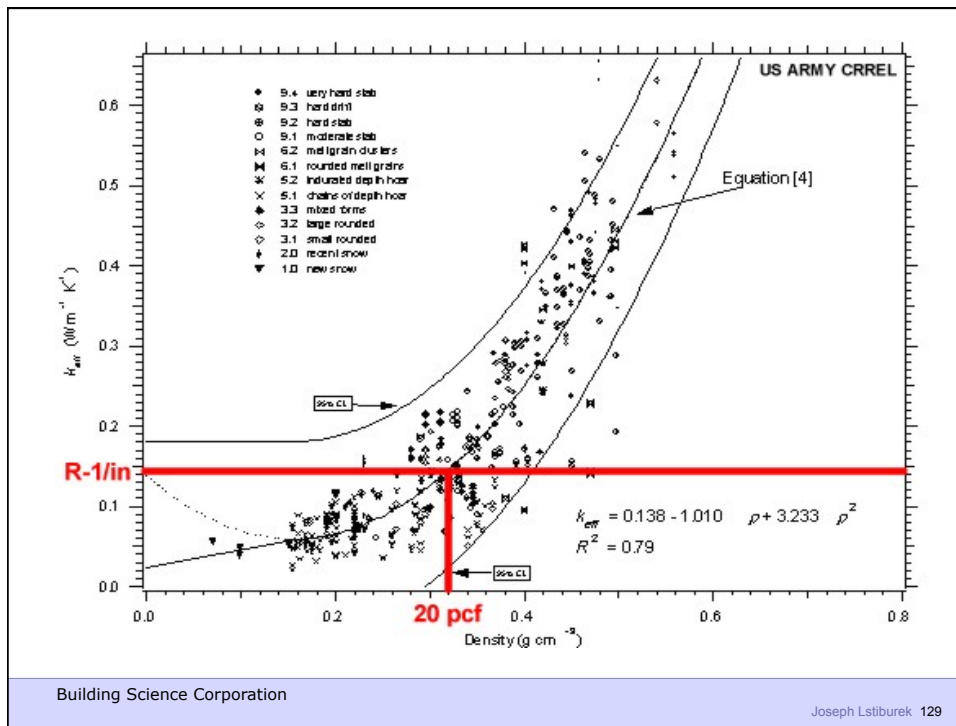



Building Science Corporation

Joseph Lstiburek 131

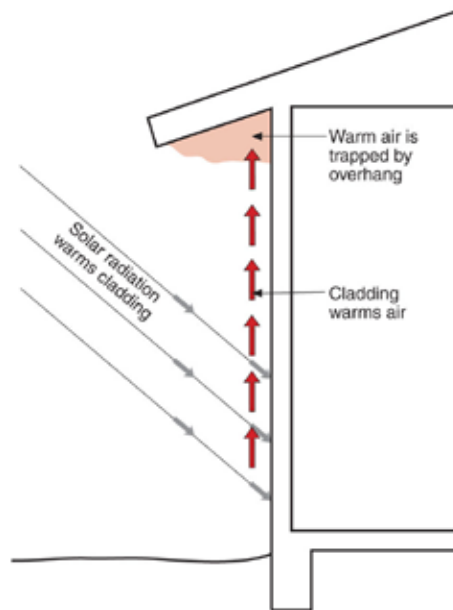

Building Science Corporation

Joseph Lstiburek 132



Building Science Corporation

Joseph Lstiburek 133



Building Science Corporation

Joseph Lstiburek 134



Building Science Corporation

Joseph Lstiburek 135



Building Science Corporation

Joseph Lstiburek 136



Building Science Corporation

Joseph Lstiburek 137



Building Science Corporation

Joseph Lstiburek 138

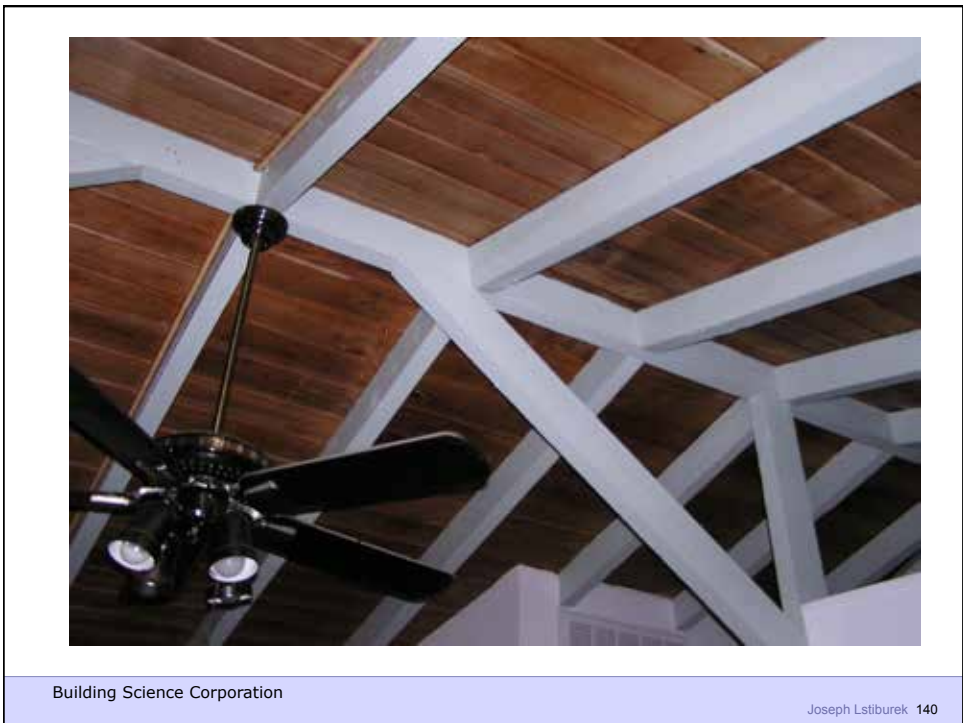
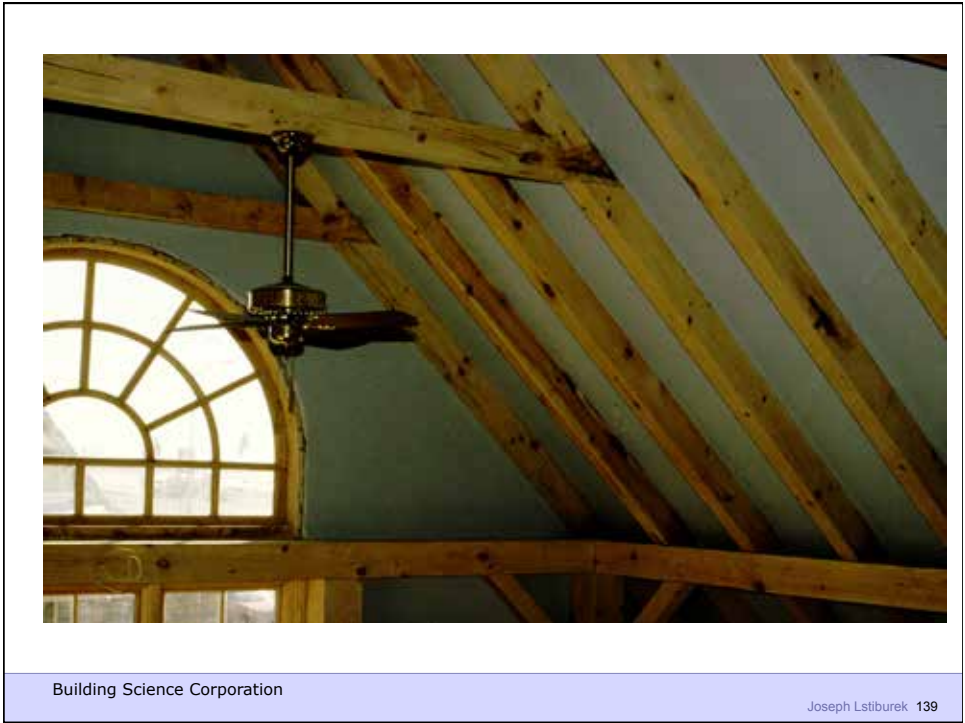



Building Science Corporation

Joseph Lstiburek 141



Building Science Corporation

Joseph Lstiburek 142





Building Science Corporation

Joseph Lstiburek 145



Building Science Corporation

Joseph Lstiburek 146



Building Science Corporation

Joseph Lstiburek 147



Building Science Corporation

Joseph Lstiburek 148

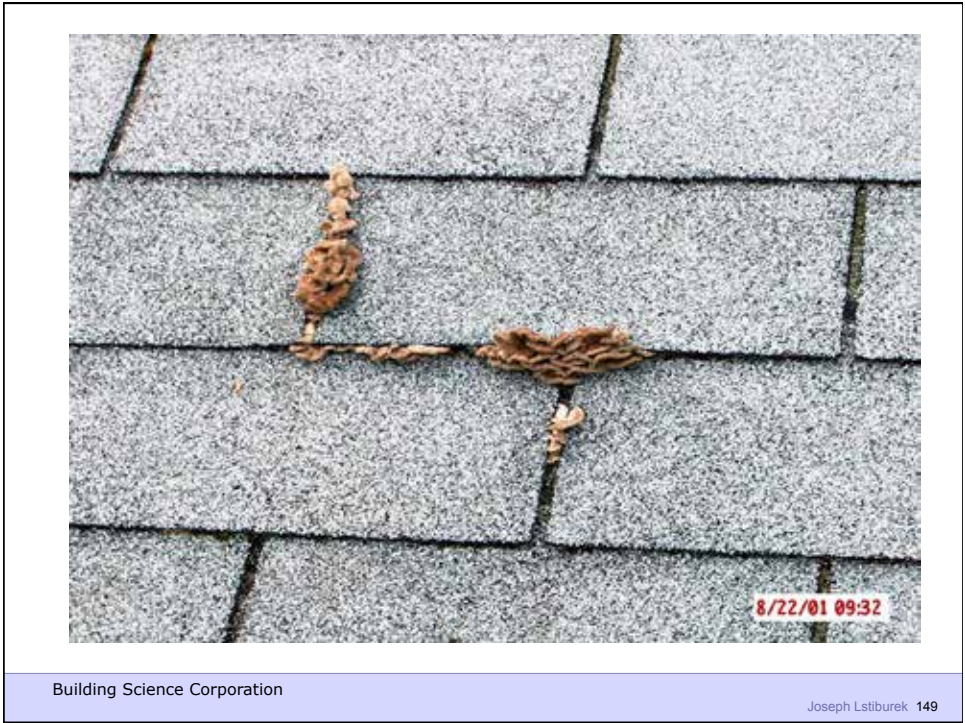



Building Science Corporation

Joseph Lstiburek 151

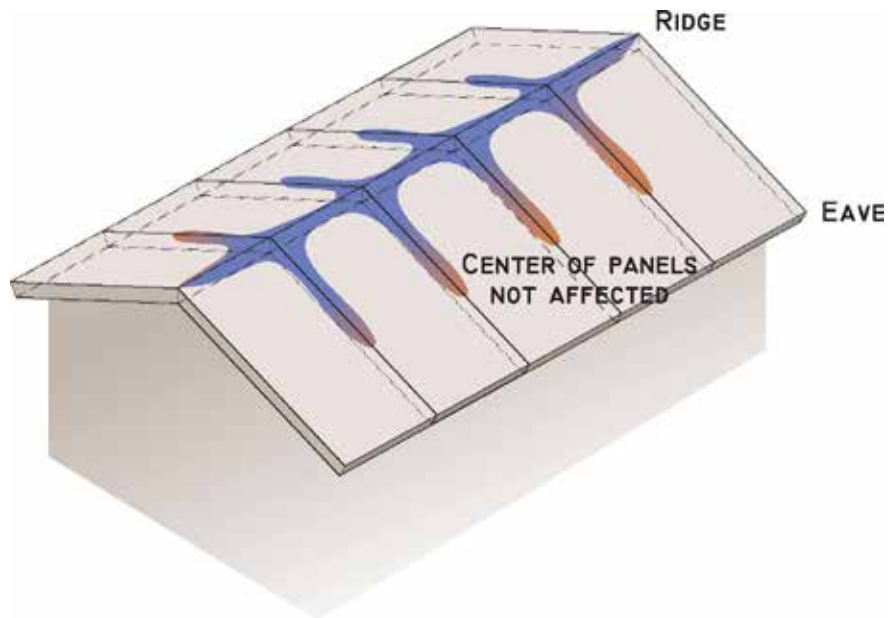

Building Science Corporation

Joseph Lstiburek 152

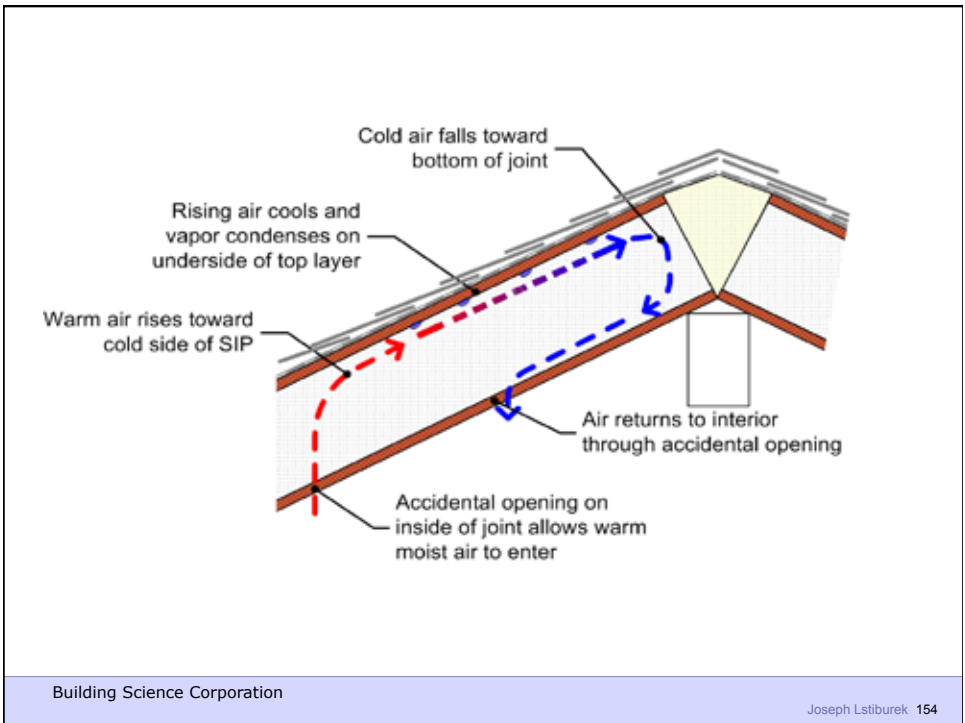

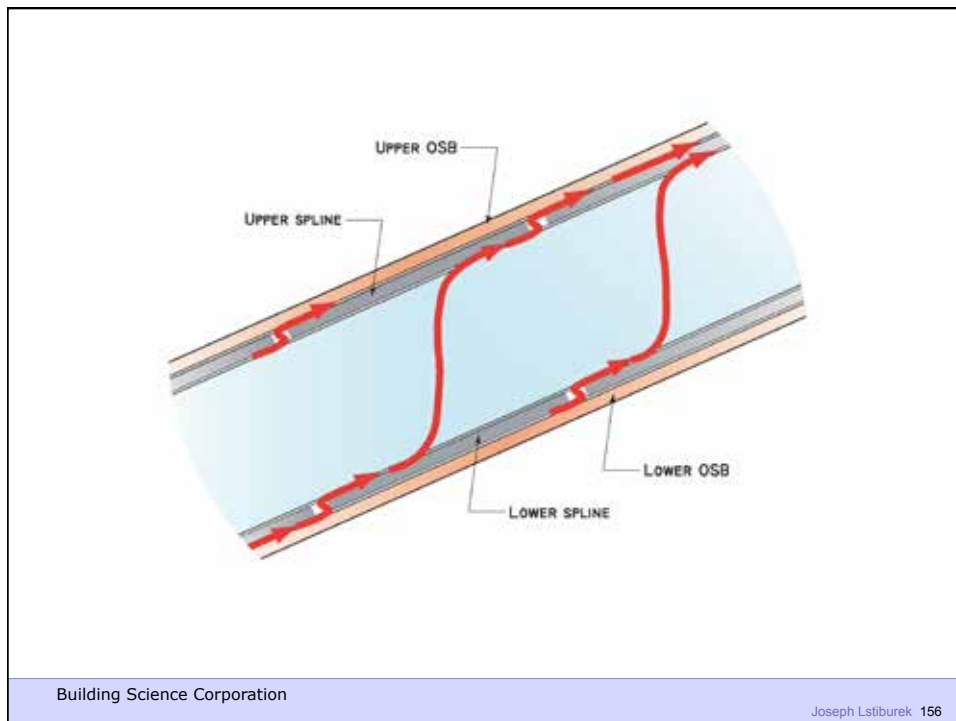
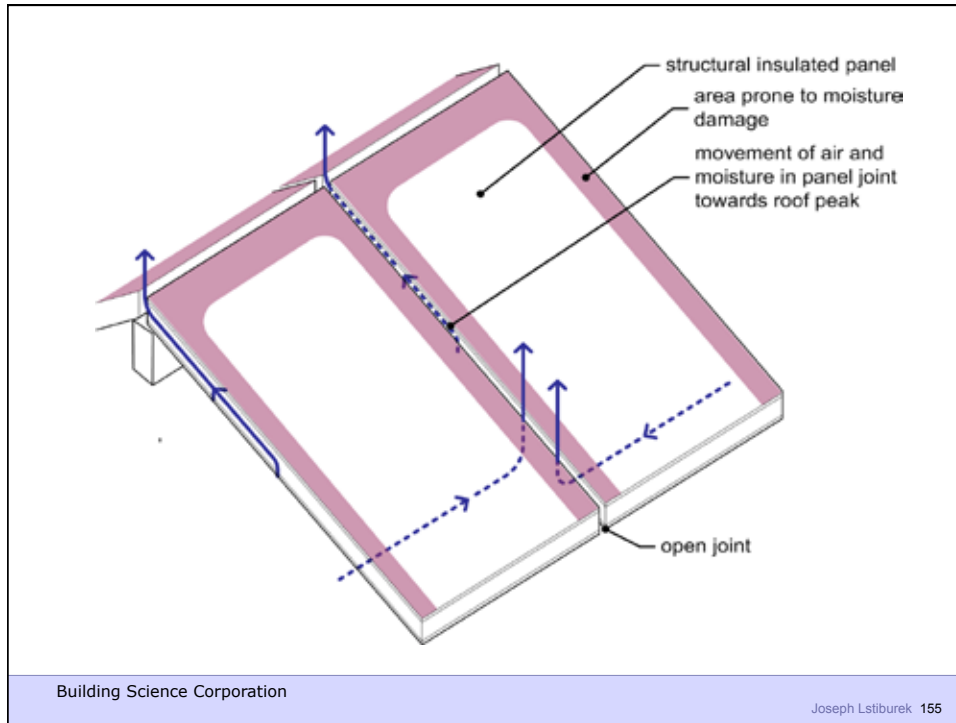



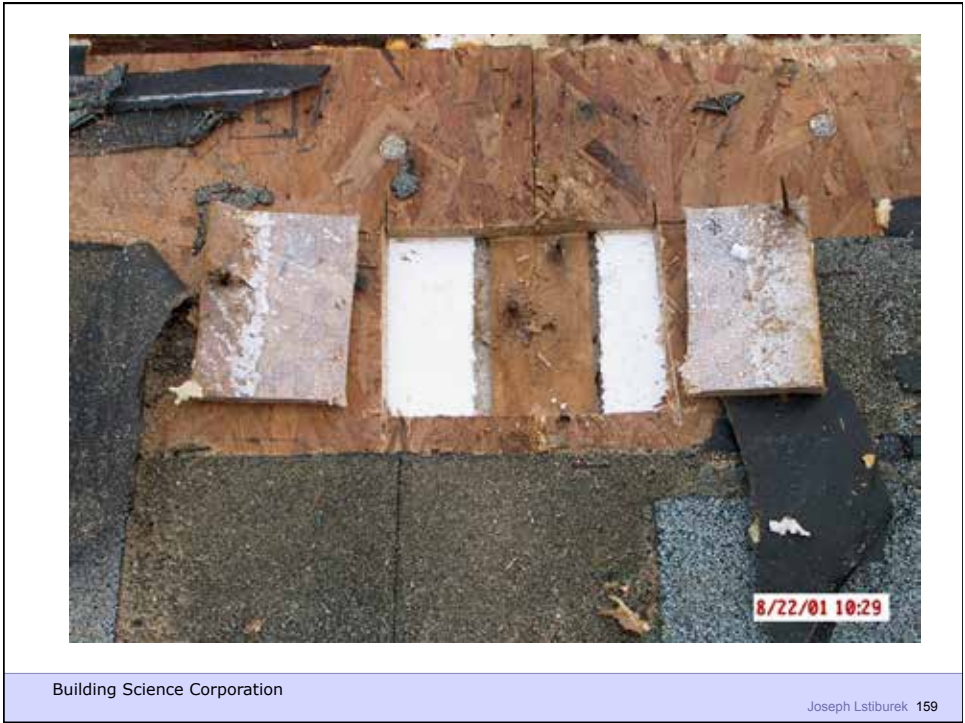



Building Science Corporation

Joseph Lstiburek 161



Building Science Corporation

Joseph Lstiburek 162



Building Science Corporation

Joseph Lstiburek 163



Building Science Corporation

Joseph Lstiburek 164

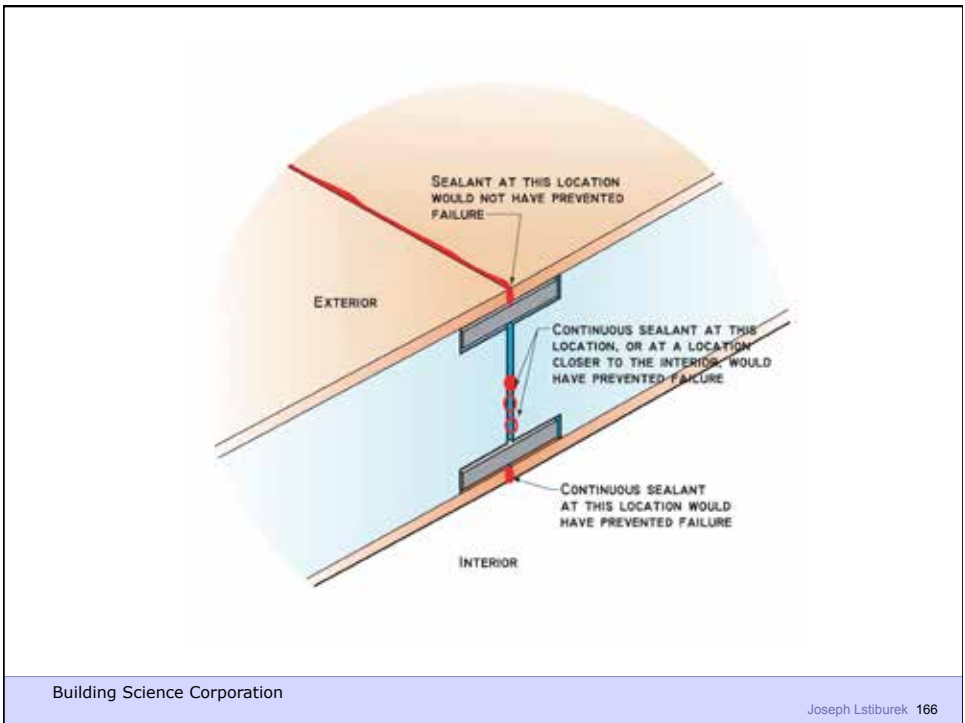

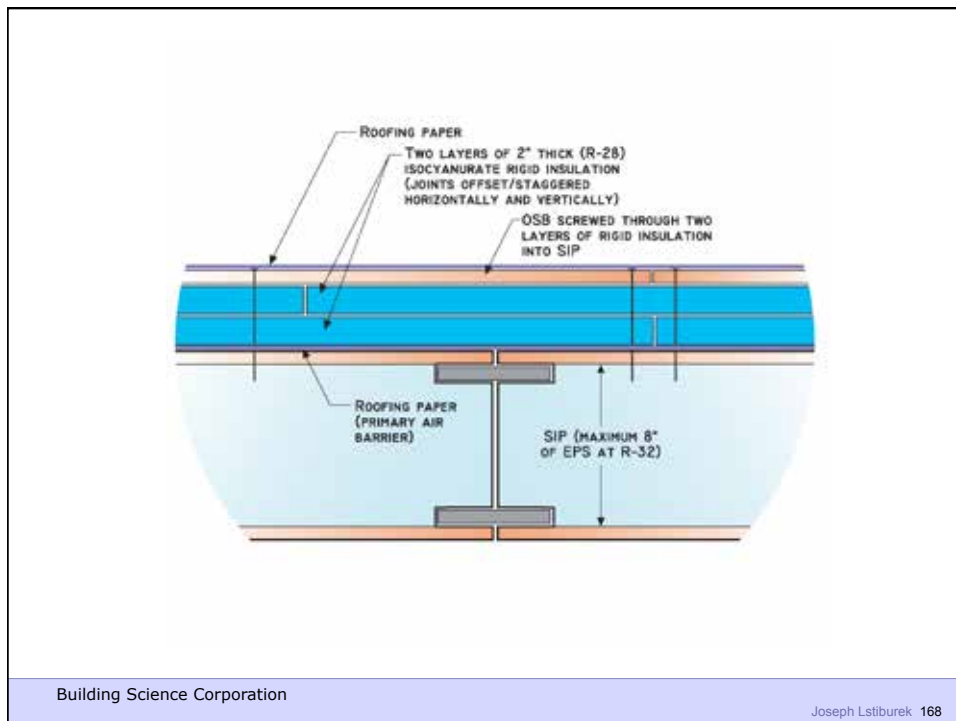
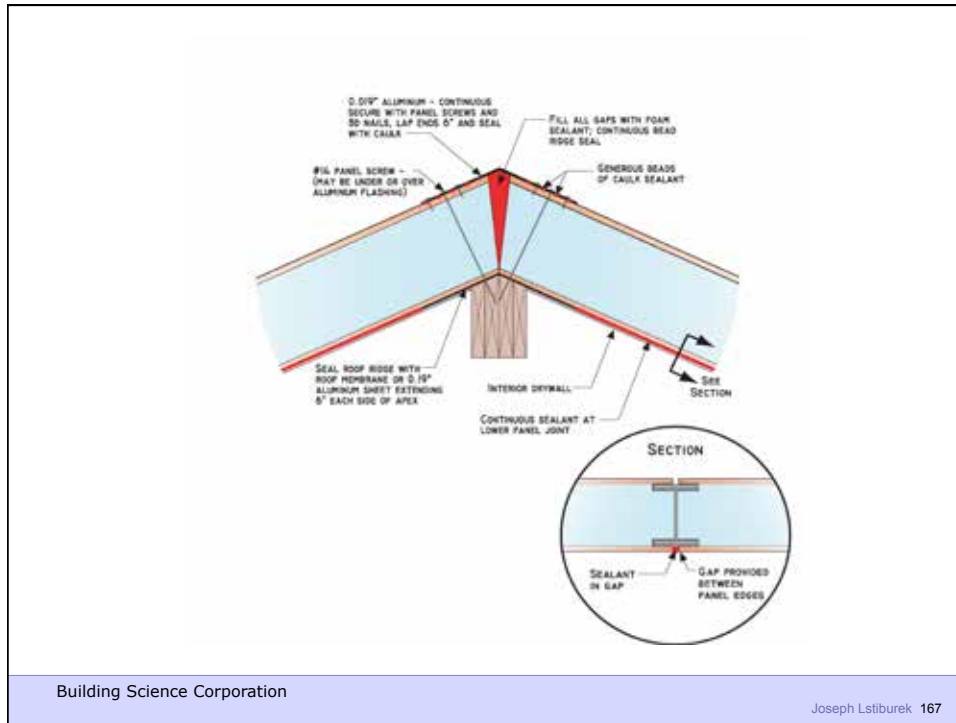

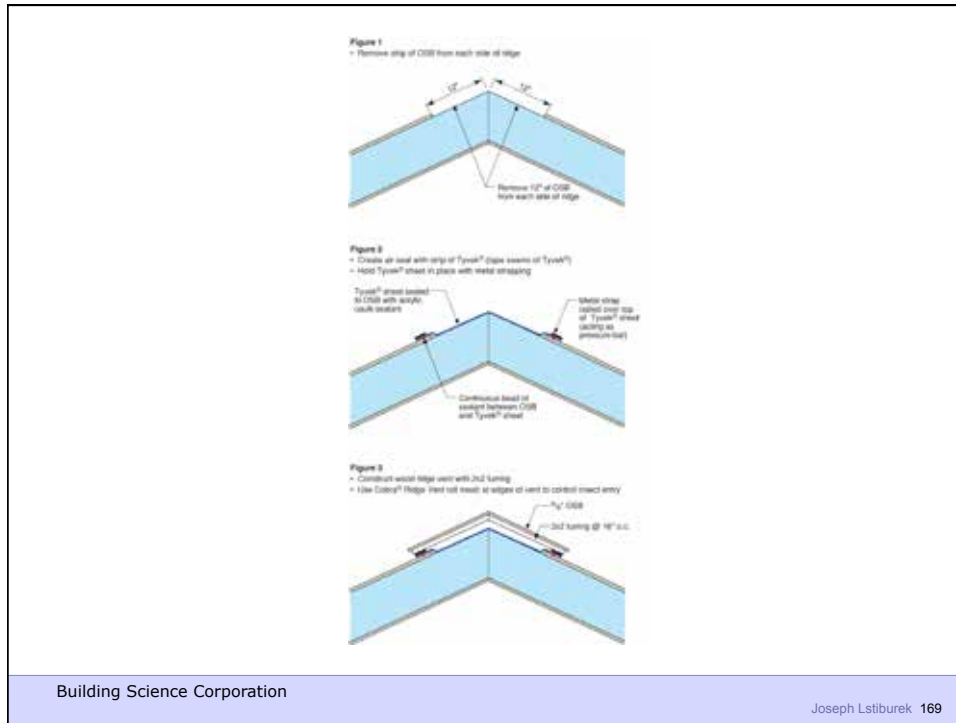



Building Science Corporation

Joseph Lstiburek 171



Building Science Corporation

Joseph Lstiburek 172



Building Science Corporation

Joseph Lstiburek 173



Building Science Corporation

Joseph Lstiburek 174



Building Science Corporation

Joseph Lstiburek 175



Building Science Corporation

Joseph Lstiburek 176



Building Science Corporation

Joseph Lstiburek 177



Building Science Corporation

Joseph Lstiburek 178



Building Science Corporation

Joseph Lstiburek 179



Building Science Corporation

Joseph Lstiburek 180



Building Science Corporation

Joseph Lstiburek 181



Building Science Corporation

Joseph Lstiburek 182



Building Science Corporation

Joseph Lstiburek 183

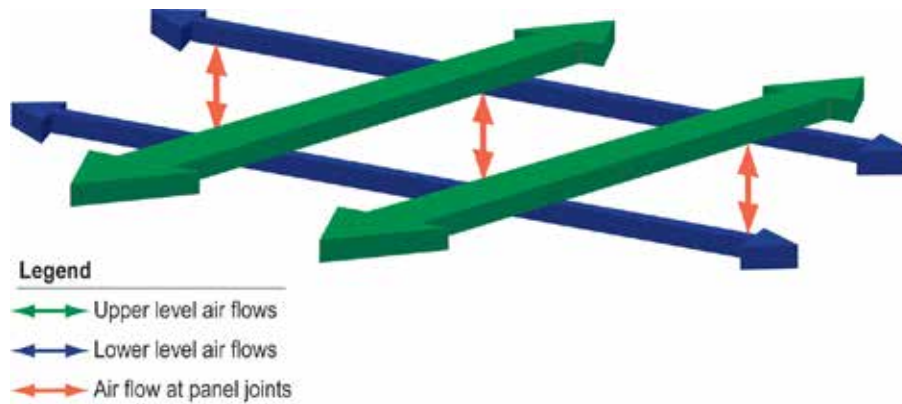

Legend

- ←→ Upper level air flows
- ←→ Lower level air flows
- ↕ Air flow at panel joints

Building Science Corporation

Joseph Lstiburek 184

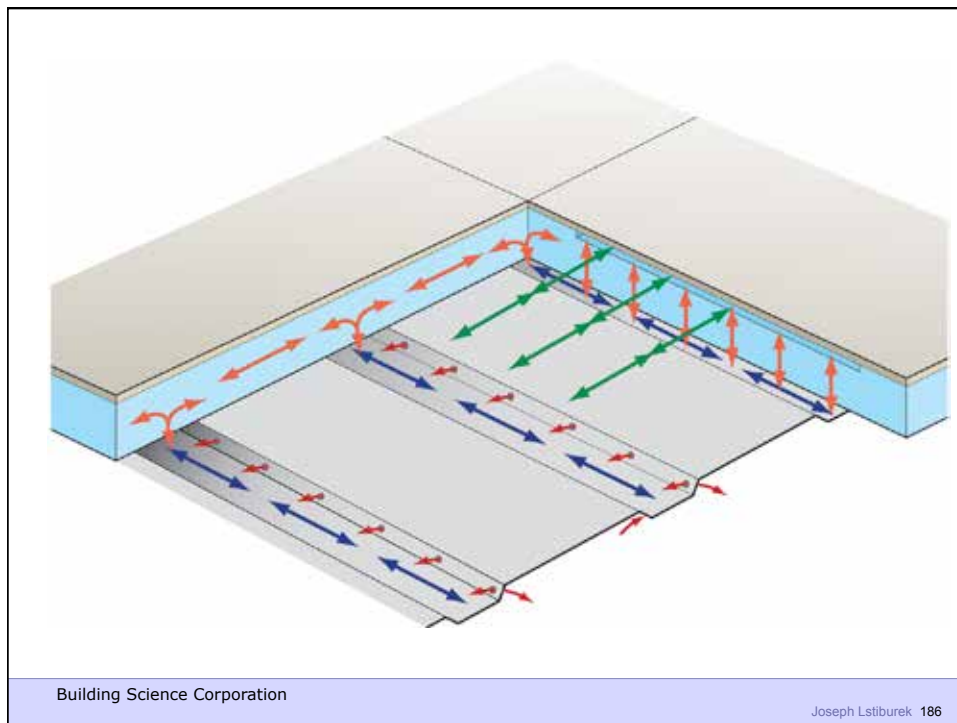
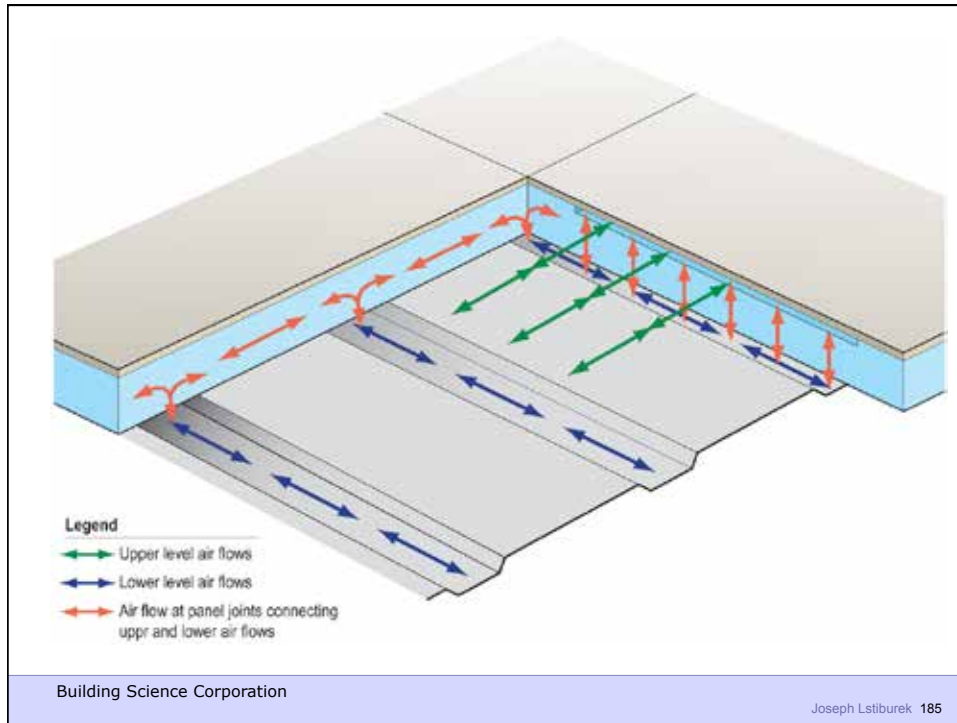



Building Science Corporation

Joseph Lstiburek 187

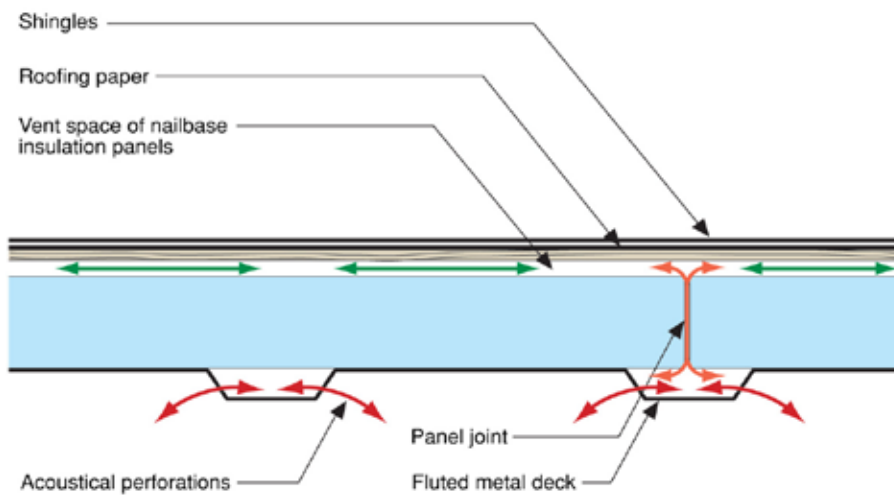

Building Science Corporation

Joseph Lstiburek 188

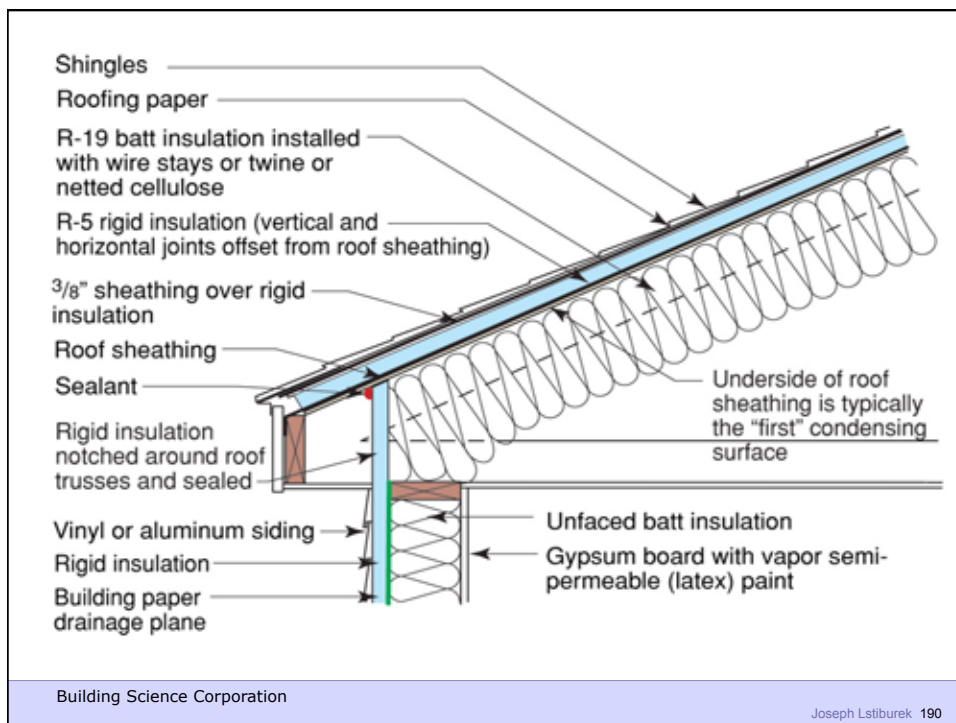
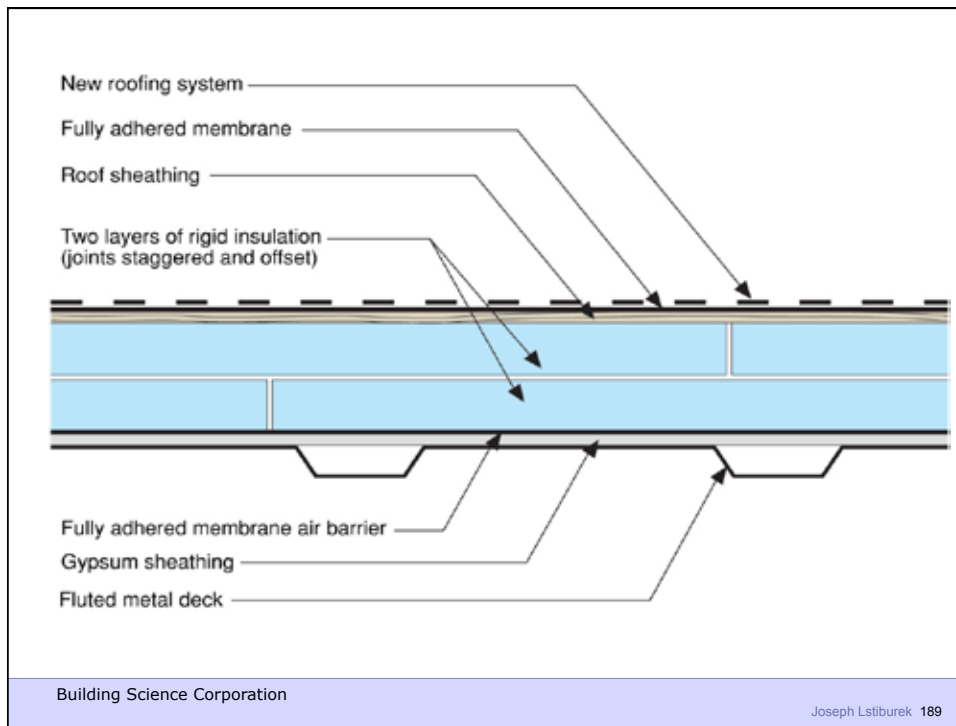

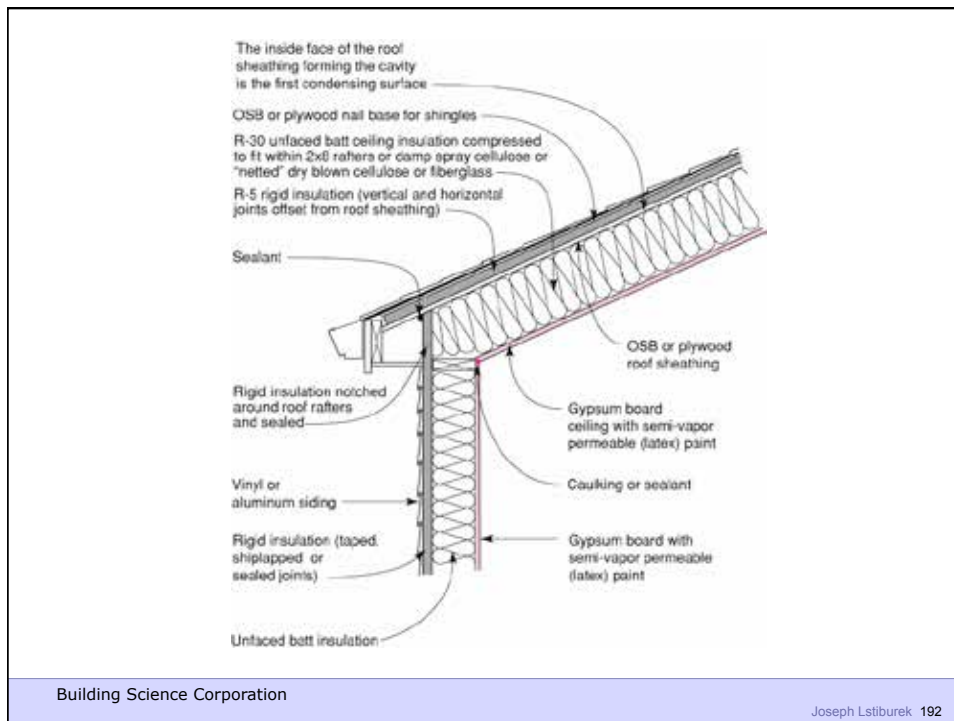
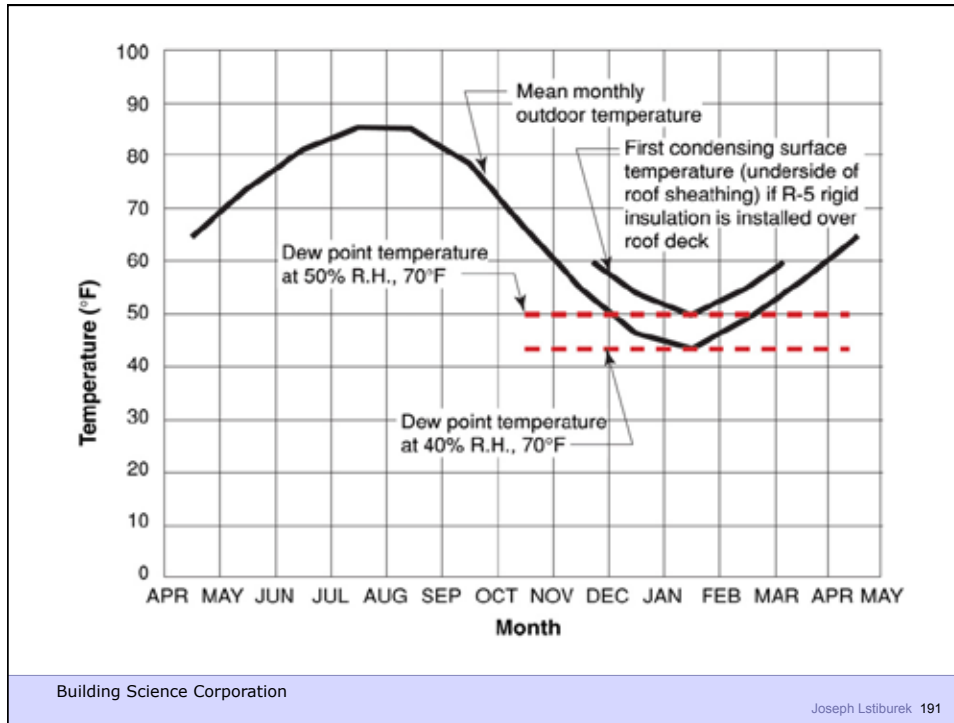

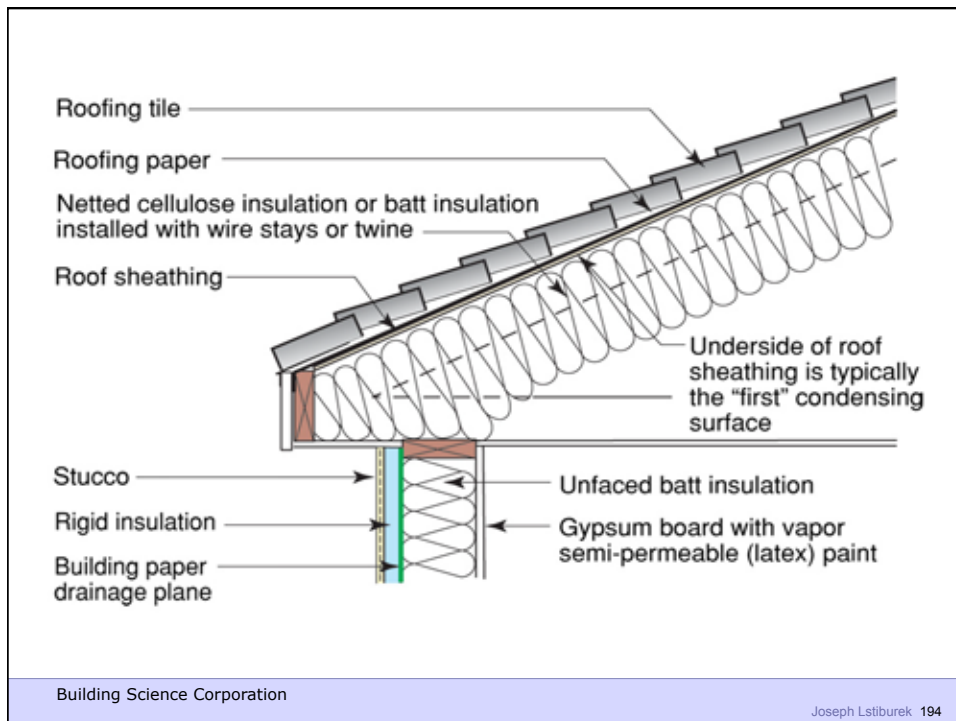
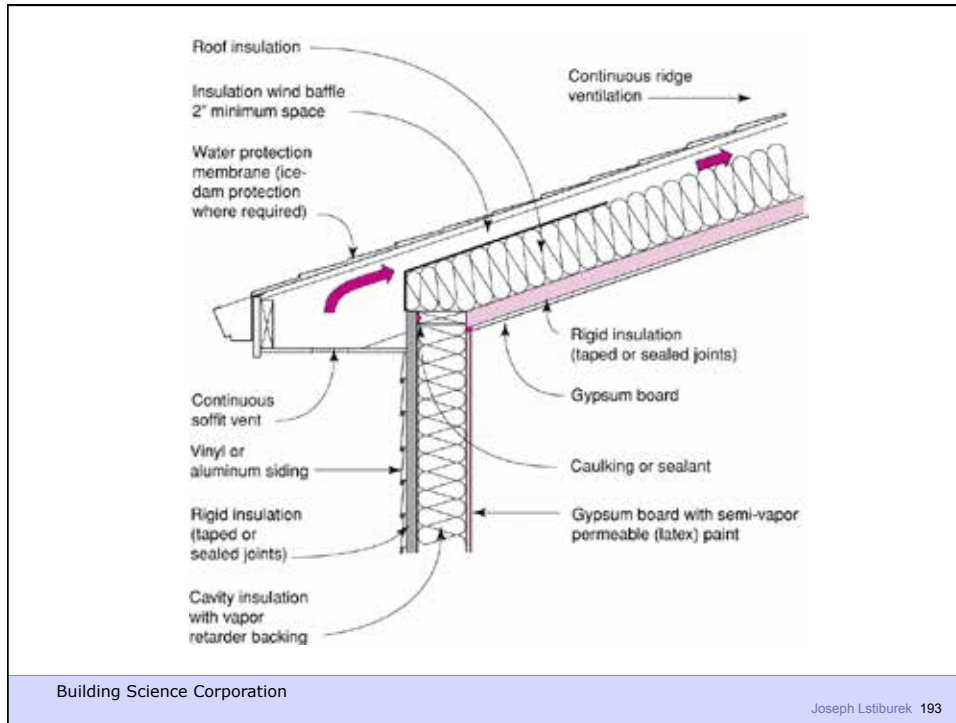

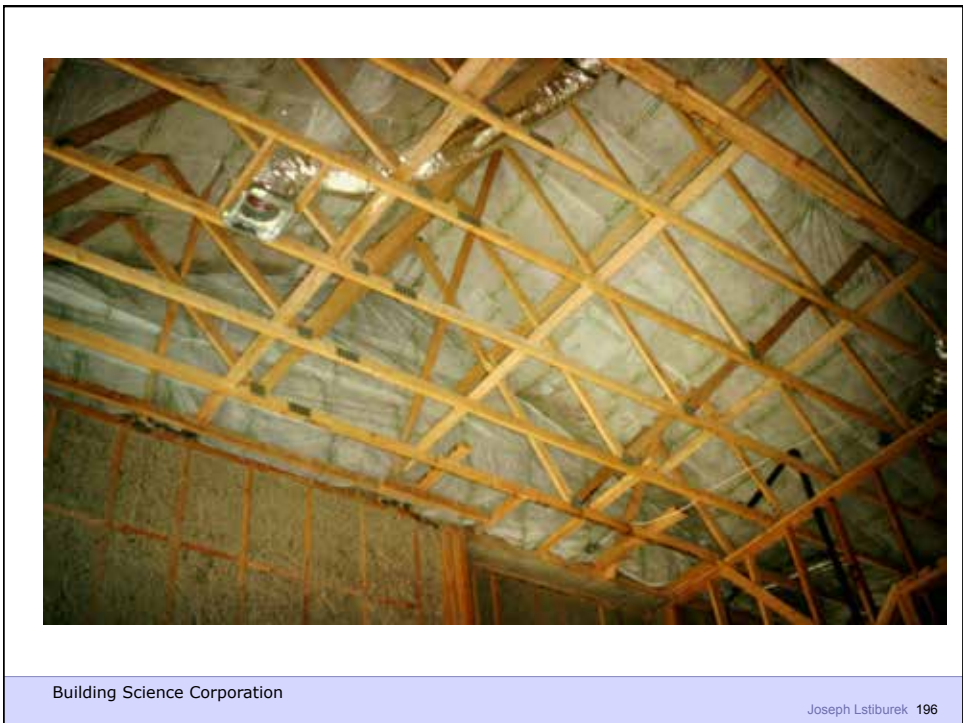



Building Science Corporation

Joseph Lstiburek 197

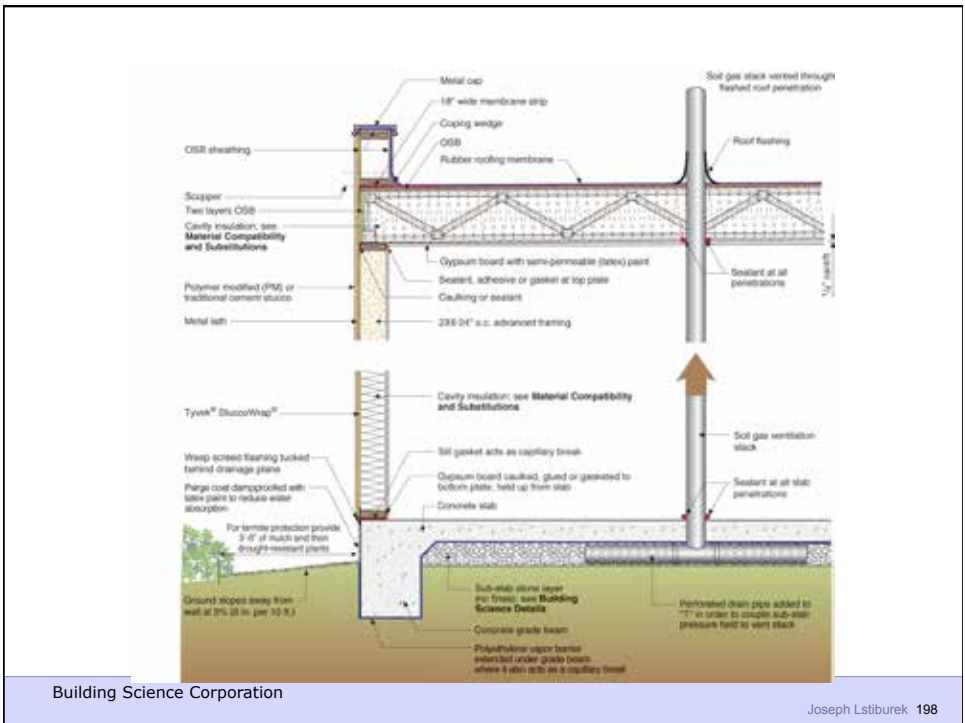

Building Science Corporation

Joseph Lstiburek 198

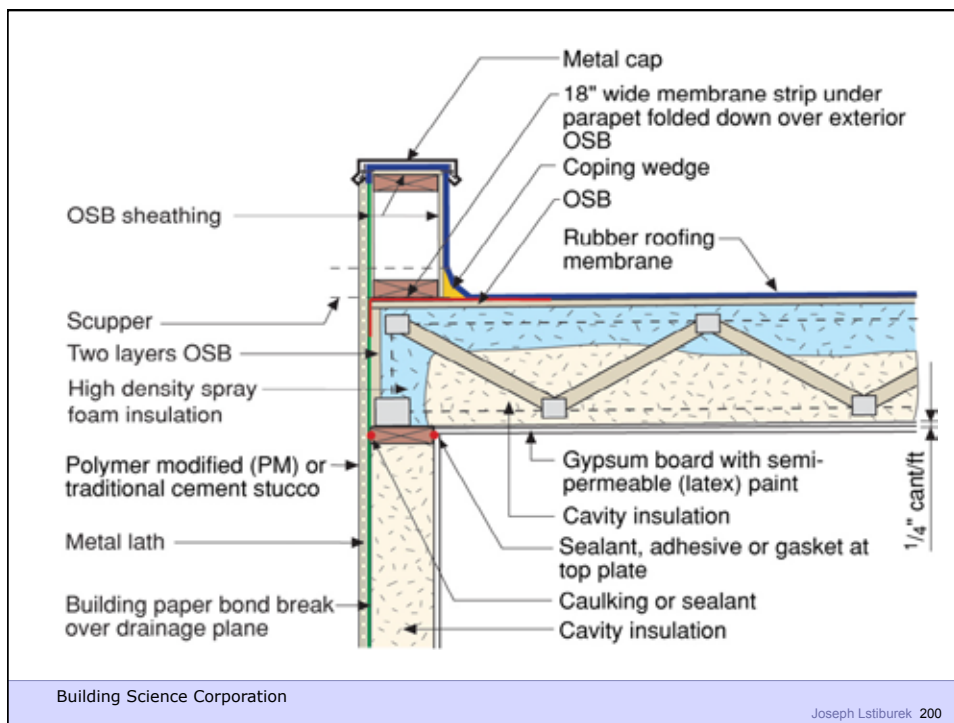
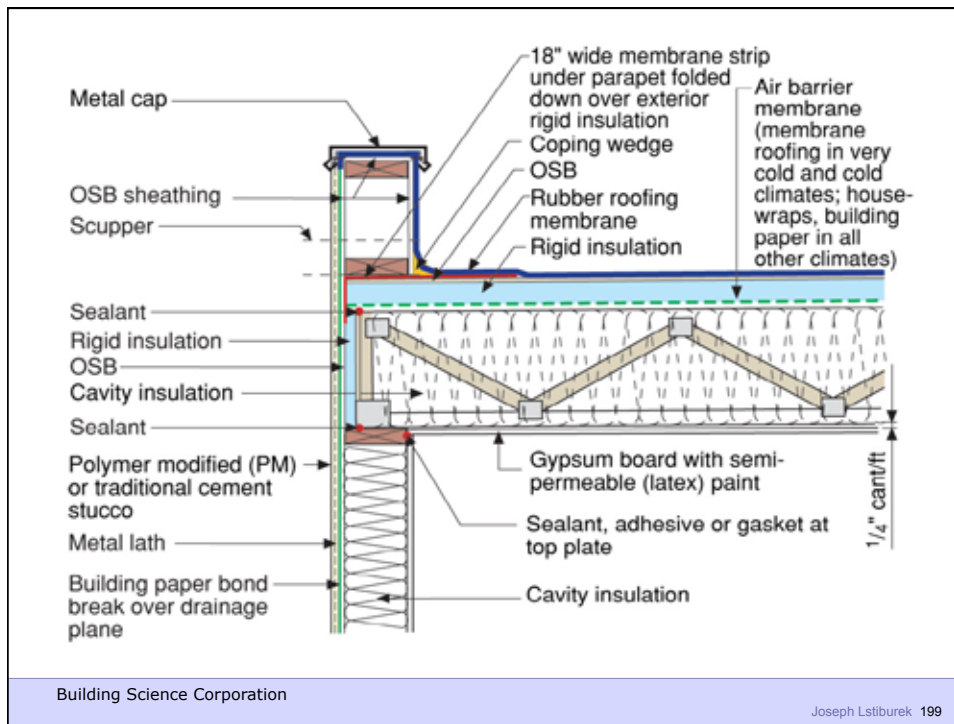

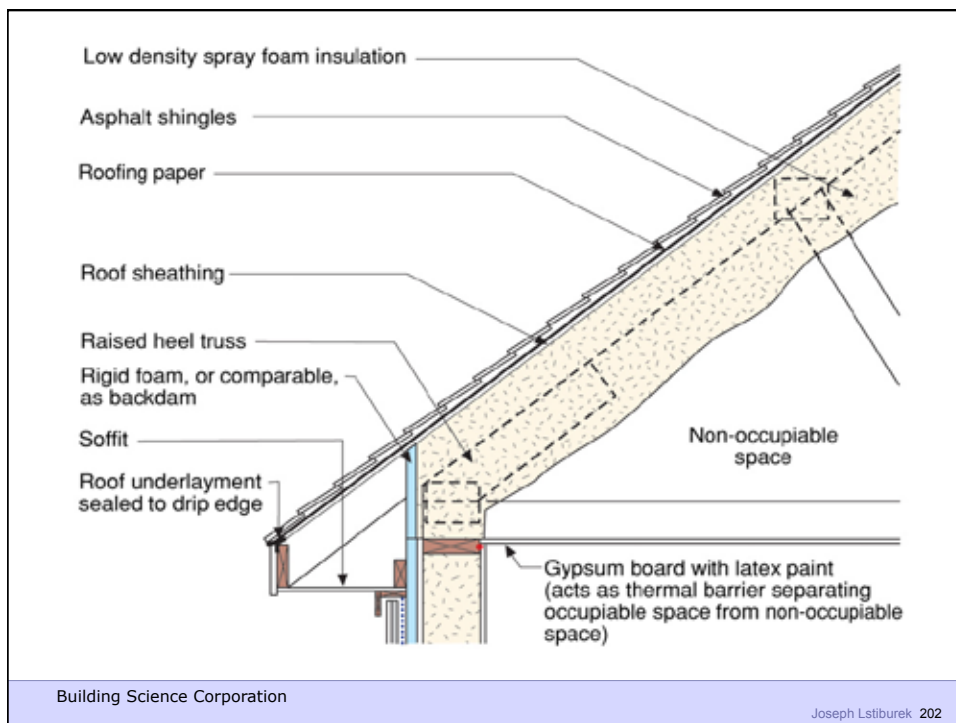
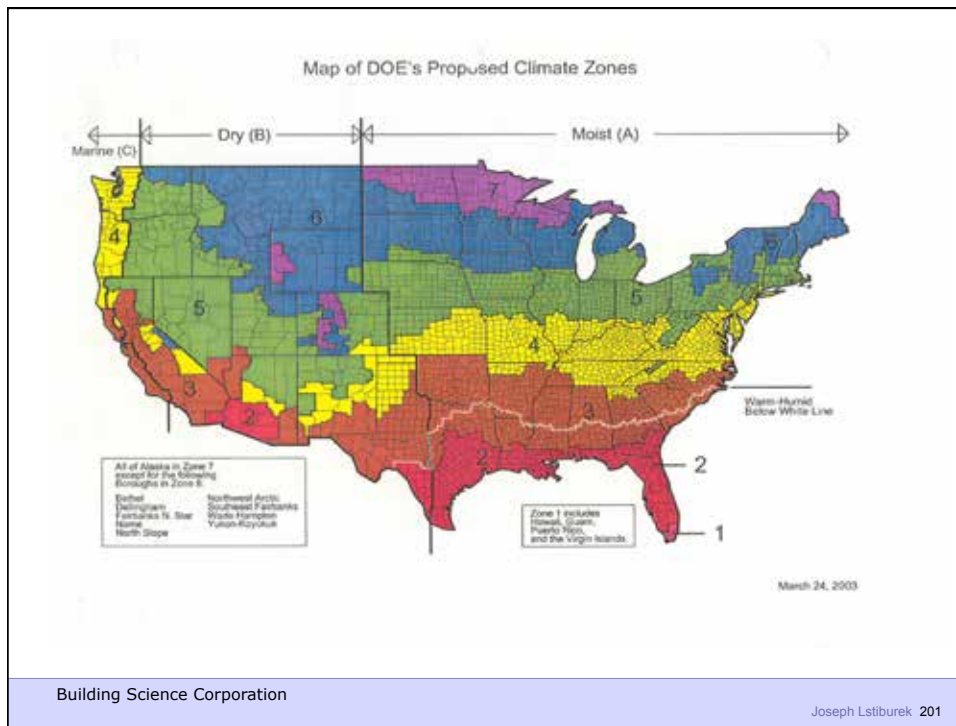



Building Science Corporation

Joseph Lstiburek 203



Building Science Corporation

Joseph Lstiburek 204

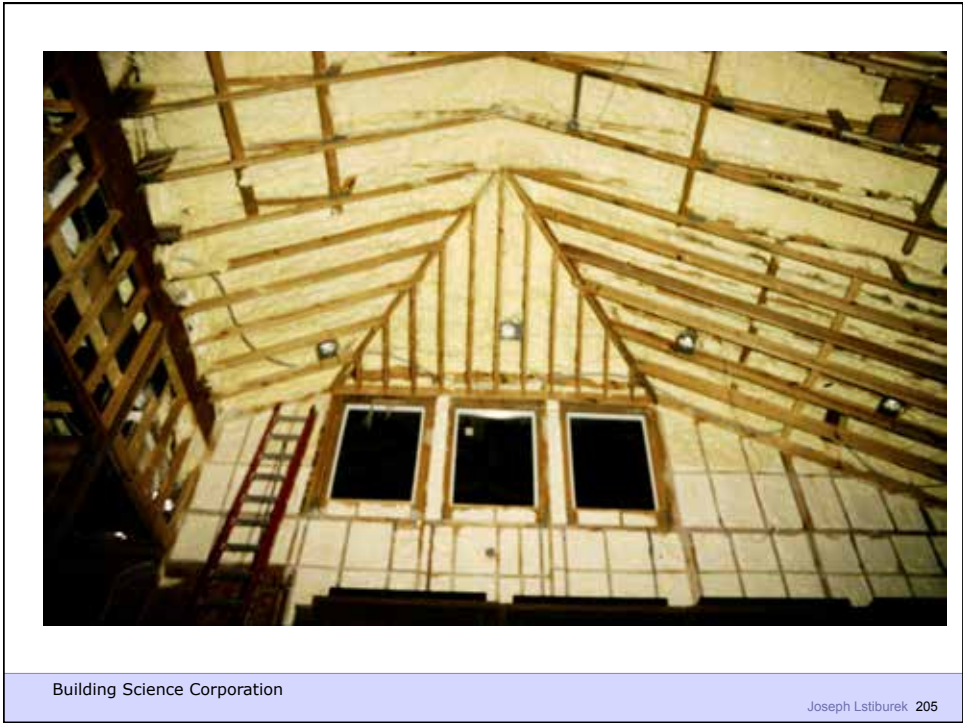

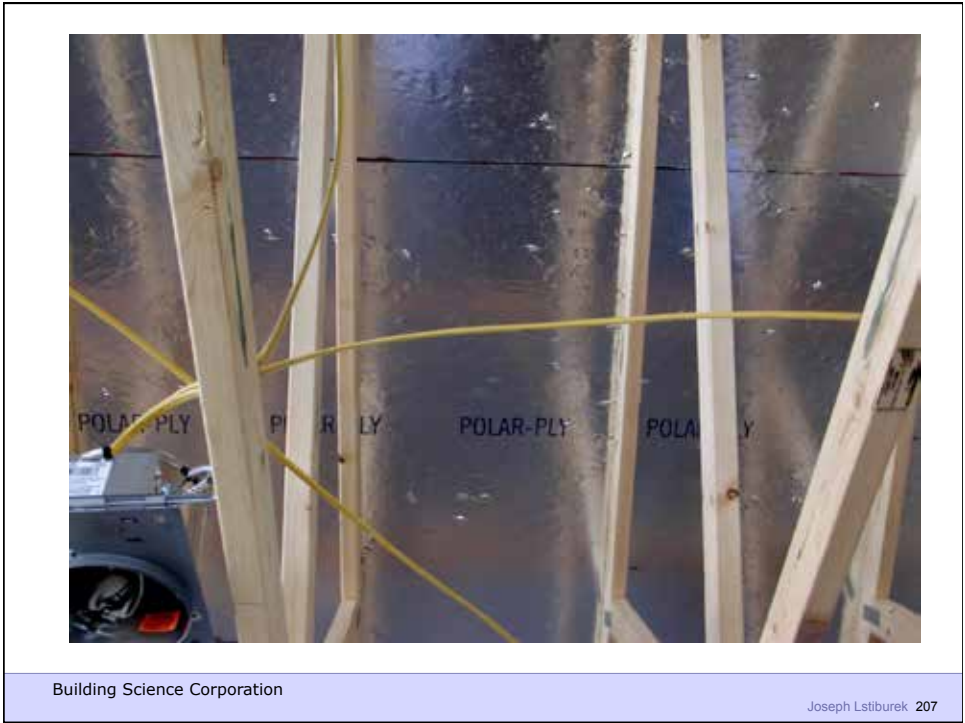



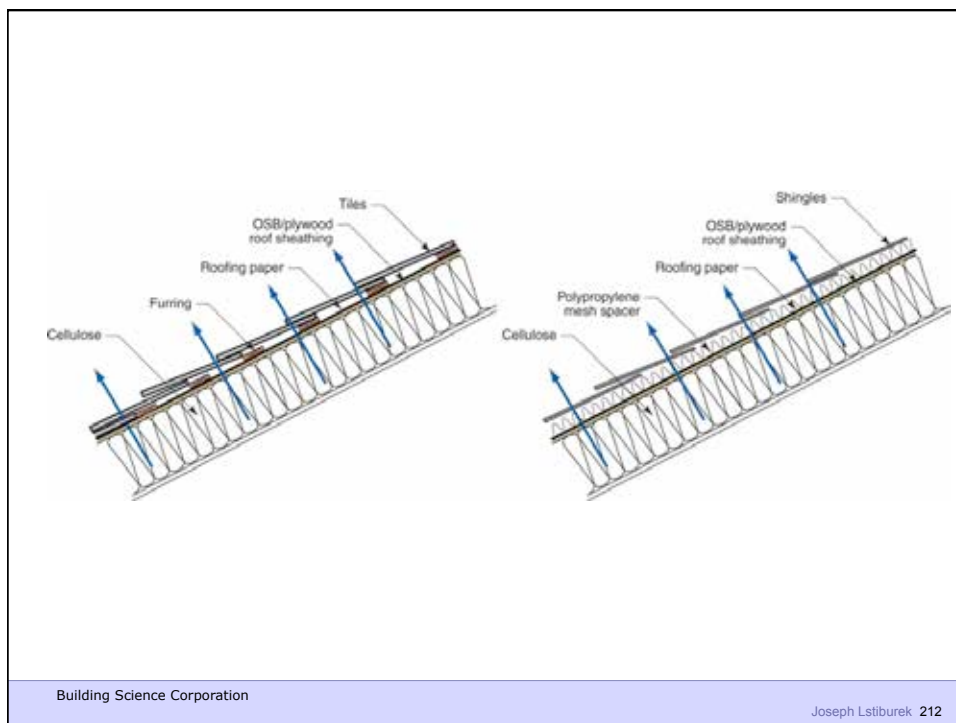
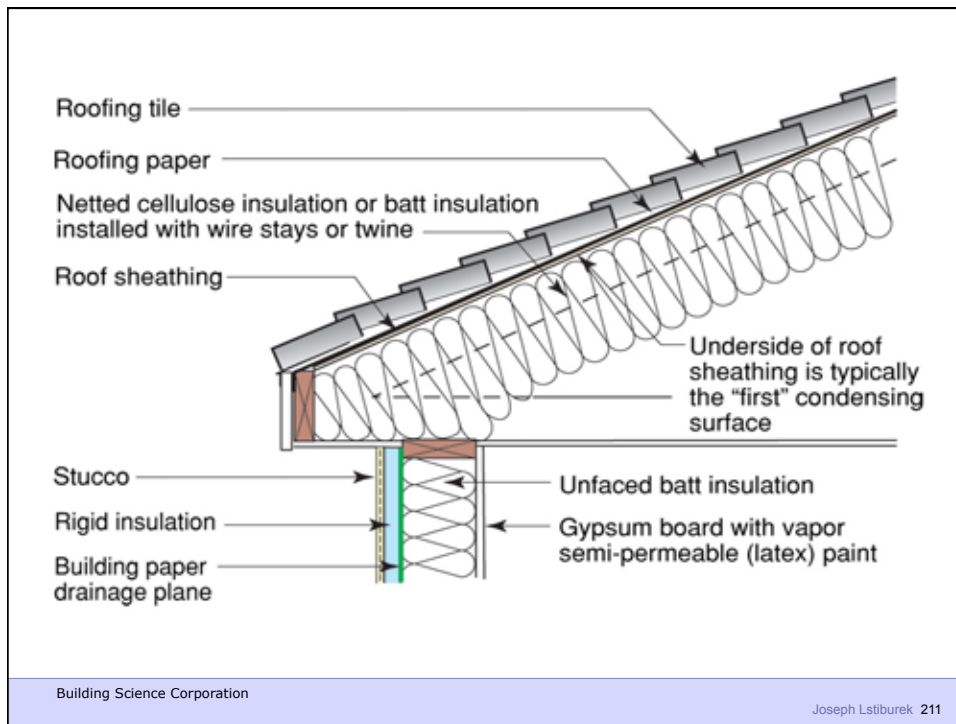

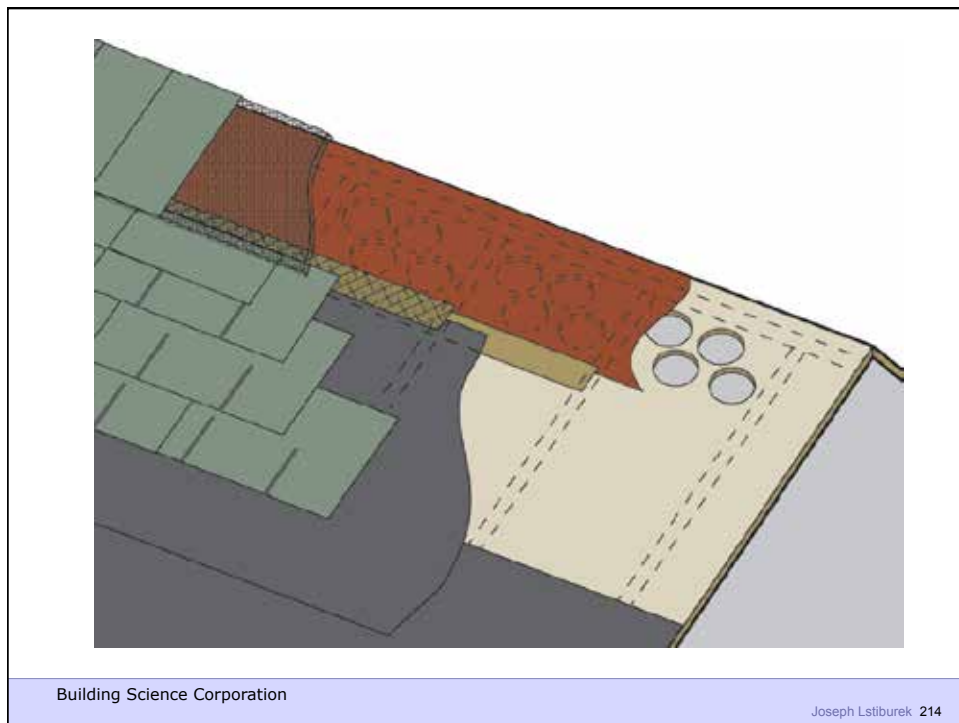
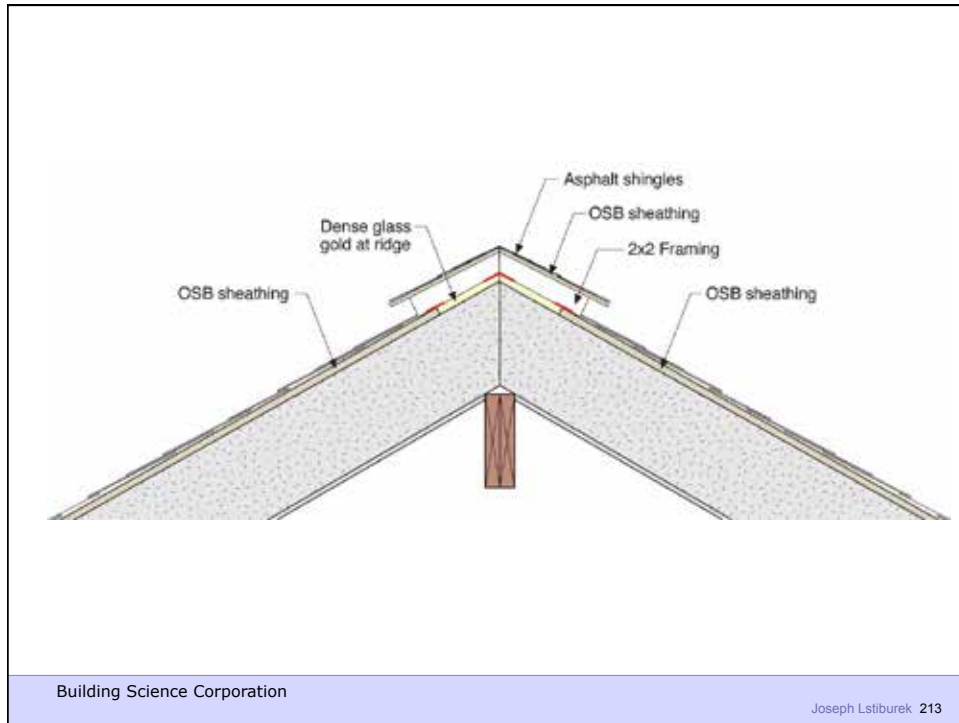

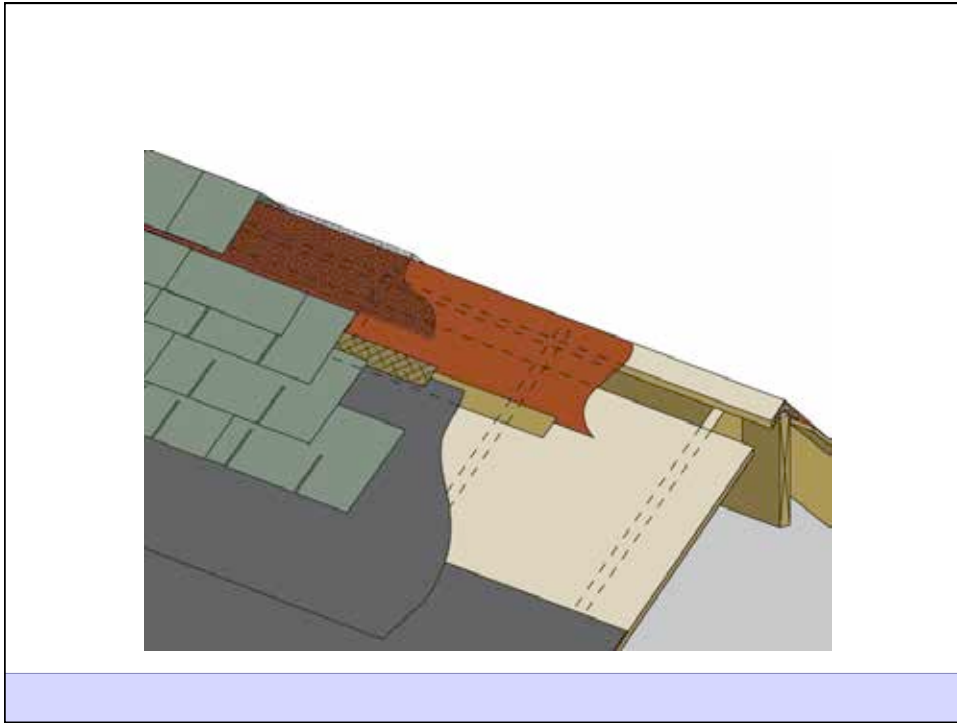



Building Science Corporation

Joseph Lstiburek 217



Building Science Corporation

Joseph Lstiburek 218



Building Science Corporation

Joseph Lstiburek 219

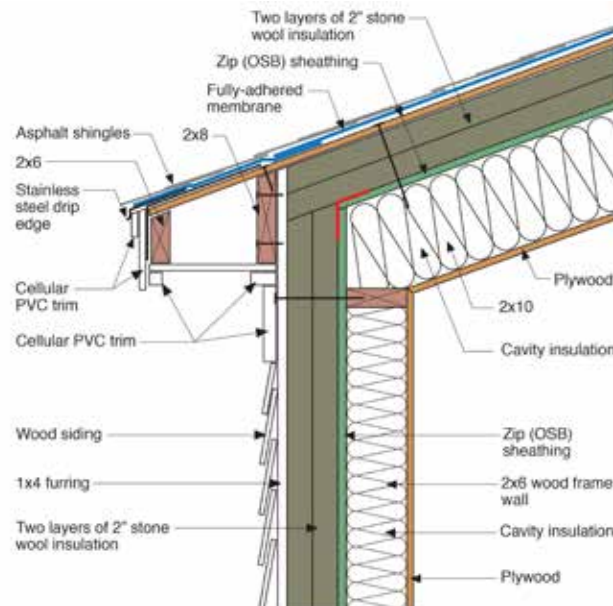

Building Science Corporation

Joseph Lstiburek 220

