

Joseph Lstiburek, Ph.D., P.Eng, ASHRAE Fellow

Building Science

Adventures In Building Science

www.buildingscience.com

Order of Magnitude

1 to 10

10 to 100

100 to 1000

1000 to 10000

First Order Effects, Second Order Effects....

Building Science Corporation

Joseph Lstiburek 2

Arrhenius Equation

Building Science Corporation

Joseph Lstiburek 3

For Every 10 Degree K Rise
Activation Energy Doubles

$$k = Ae^{-E_a/(RT)}$$

Building Science Corporation

Joseph Lstiburek 4

Damage Functions
Water
Heat
Ultra-violet Radiation

Vapor Pressure and Relative Humidity

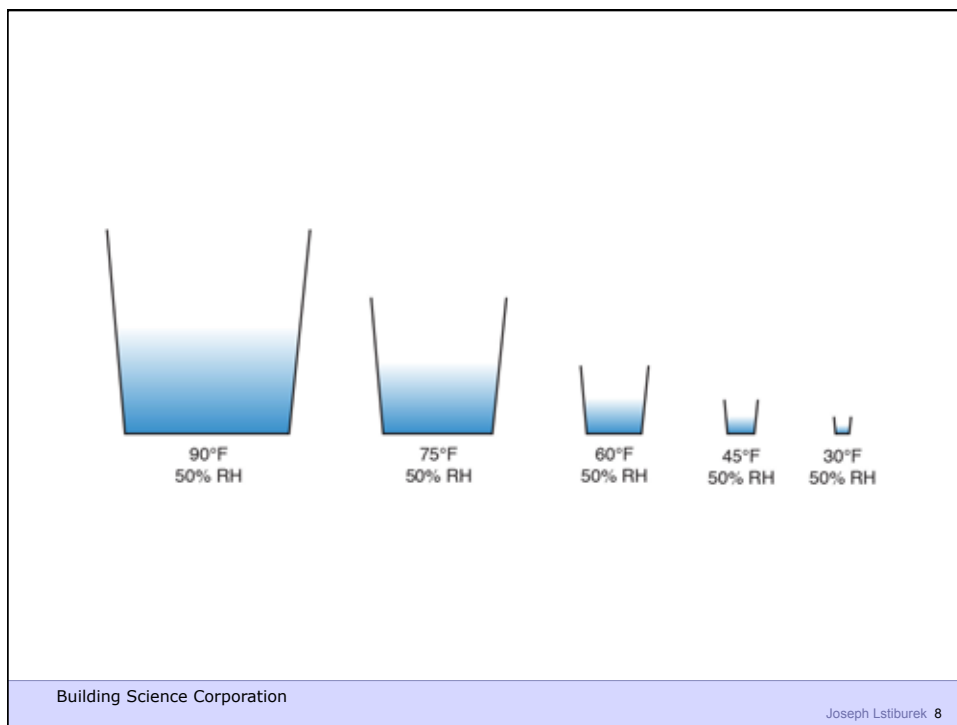
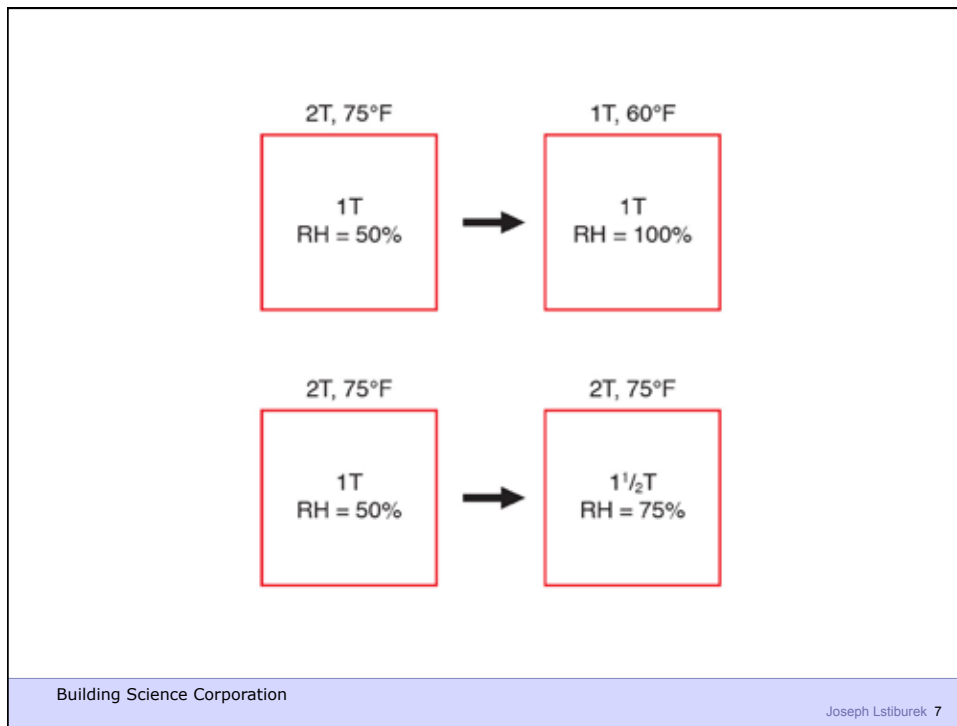

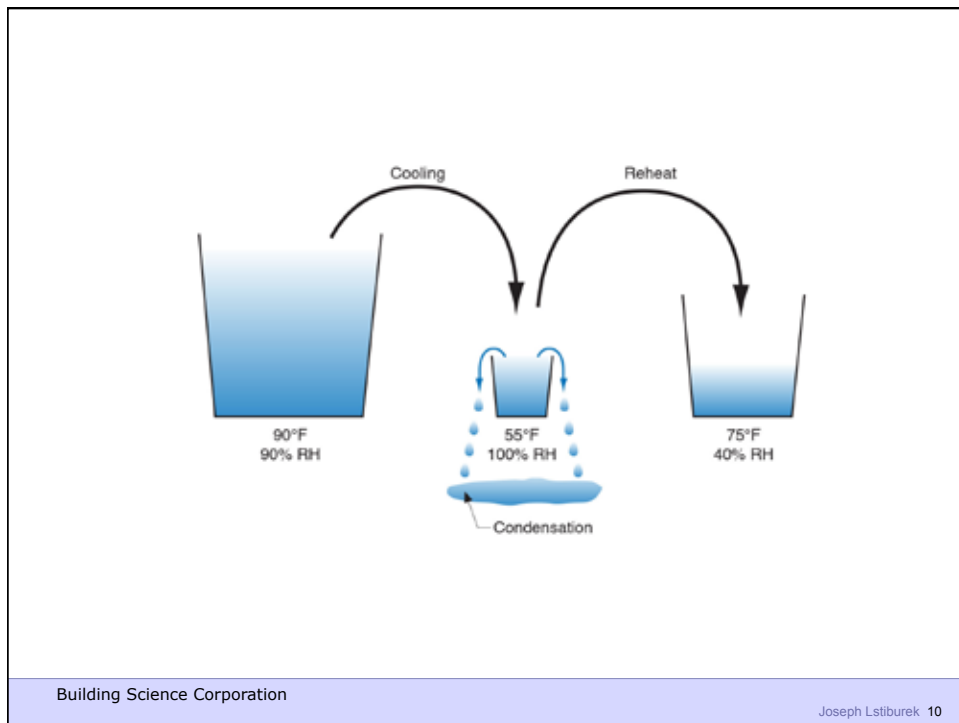
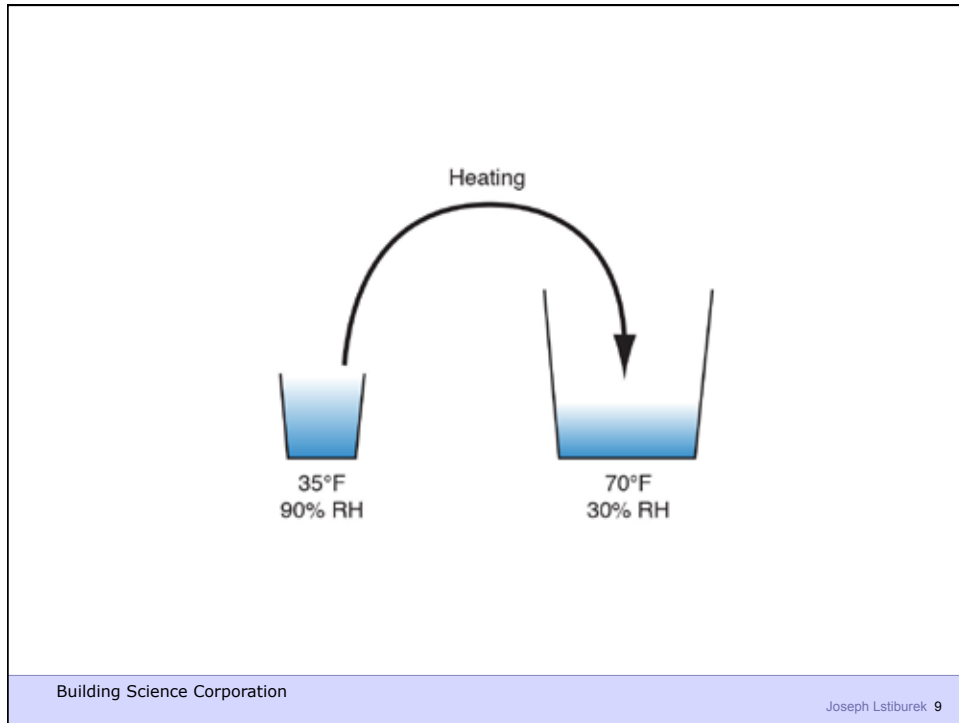

Laws of Thermodynamics

Zeroth Law – $A=B$ and $B=C$ therefore $A=C$

First Law - Conservation of Energy

Second Law - Entropy

Third Law – Absolute Zero

2nd Law of Thermodynamics

Building Science Corporation

Joseph Lstiburek 13

In an isolated system, a process can occur only if it increases the total entropy of the system

Rudolf Clausius

Building Science Corporation

Joseph Lstiburek 14

Heat Flow Is From Warm To Cold
Moisture Flow Is From Warm To Cold
Moisture Flow Is From More To Less
Air Flow Is From A Higher Pressure to a
Lower Pressure
Gravity Acts Down

Moisture Flow Is From Warm To Cold
Moisture Flow Is From More To Less

Moisture Flow Is From Warm To Cold
Moisture Flow Is From More To Less

Thermal Gradient – Thermal Diffusion
Concentration Gradient – Molecular Diffusion

Moisture Flow Is From Warm To Cold
Moisture Flow Is From More To Less

Thermal Gradient – Thermal Diffusion
Concentration Gradient – Molecular Diffusion

Vapor Diffusion

Thermodynamic Potential

Building Science Corporation

Joseph Lstiburek 19

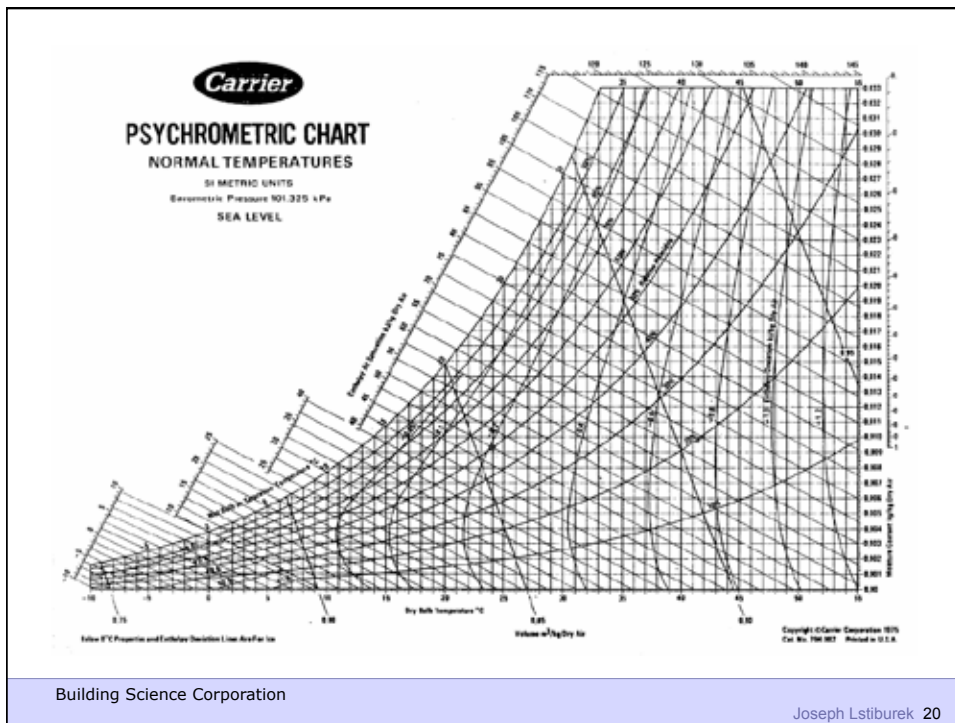

Building Science Corporation

Joseph Lstiburek 20

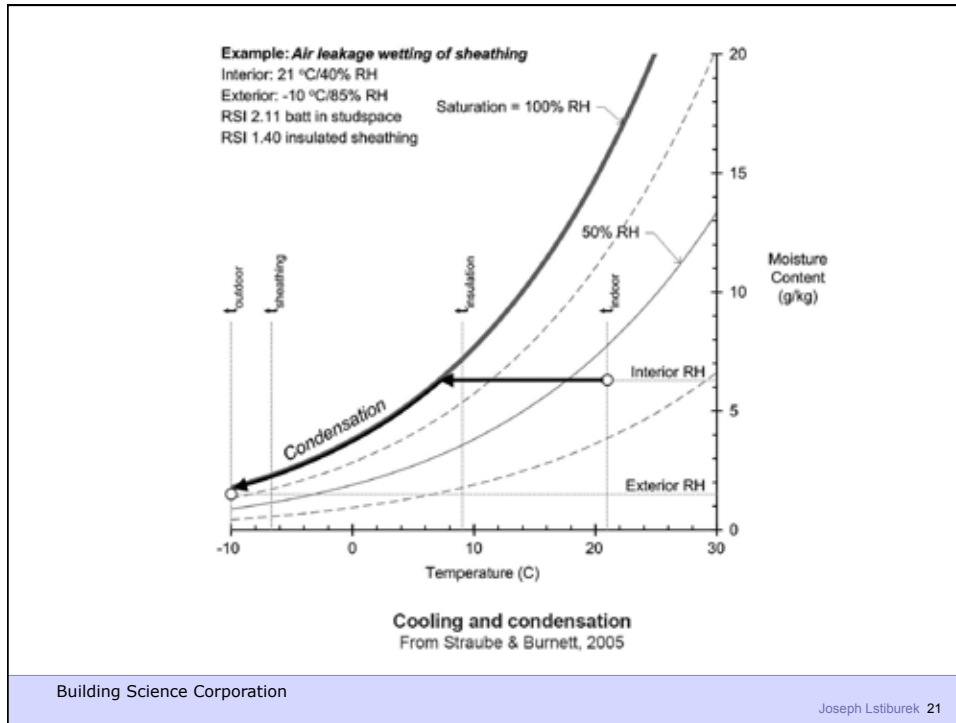

Sorption Isotherms

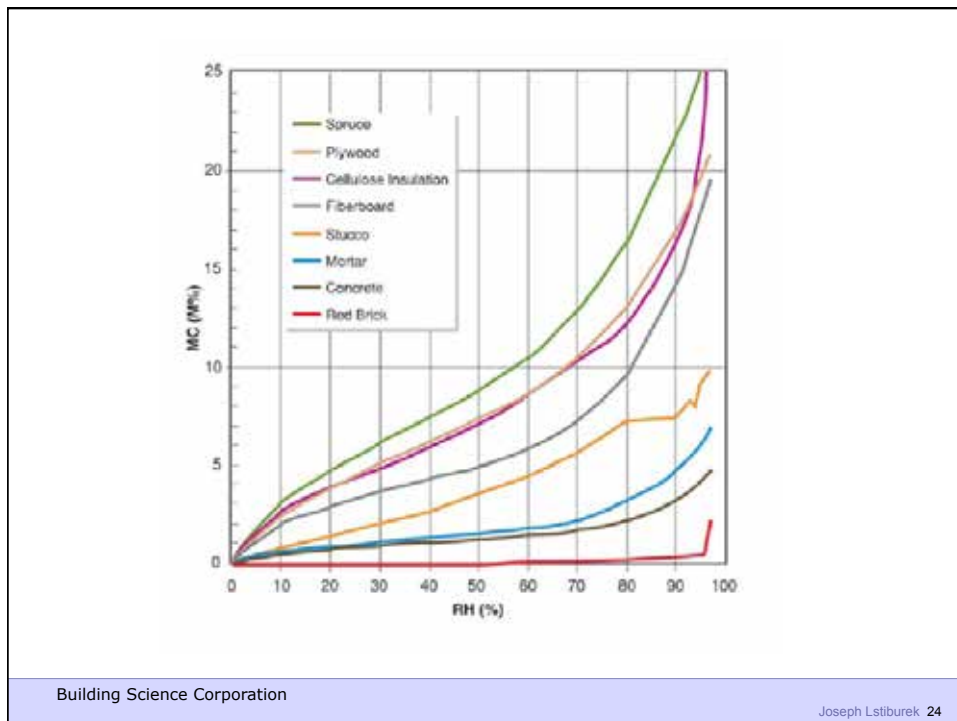
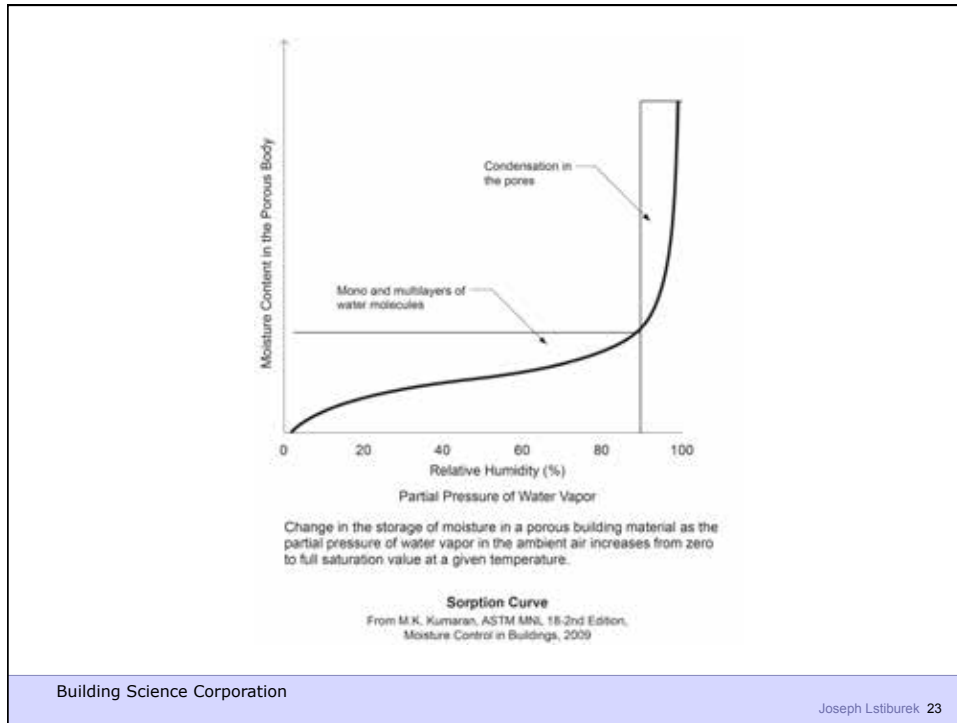

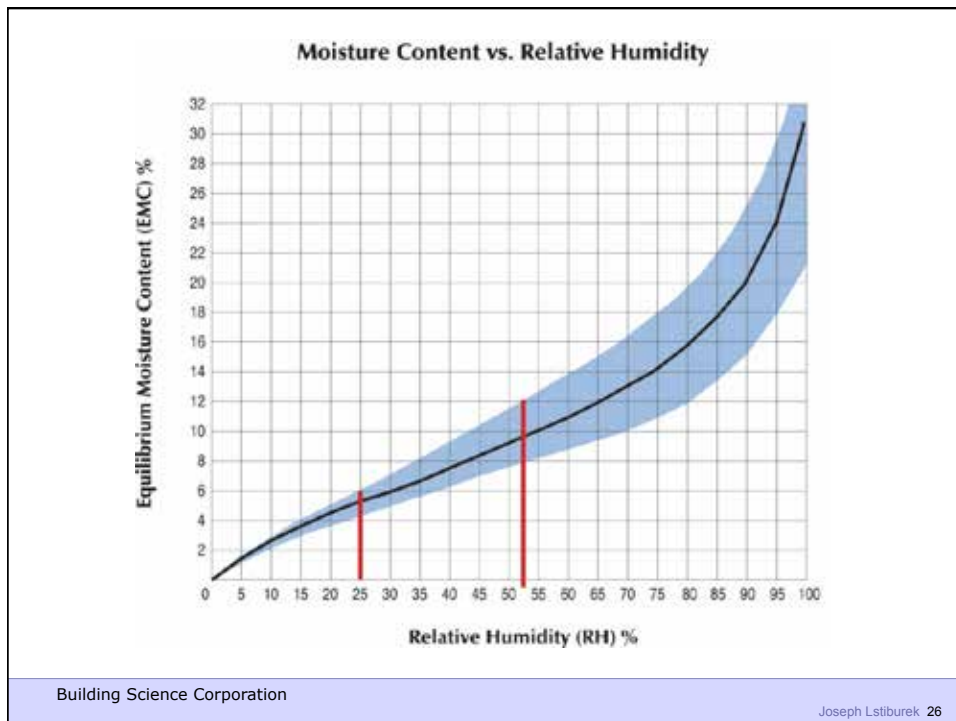
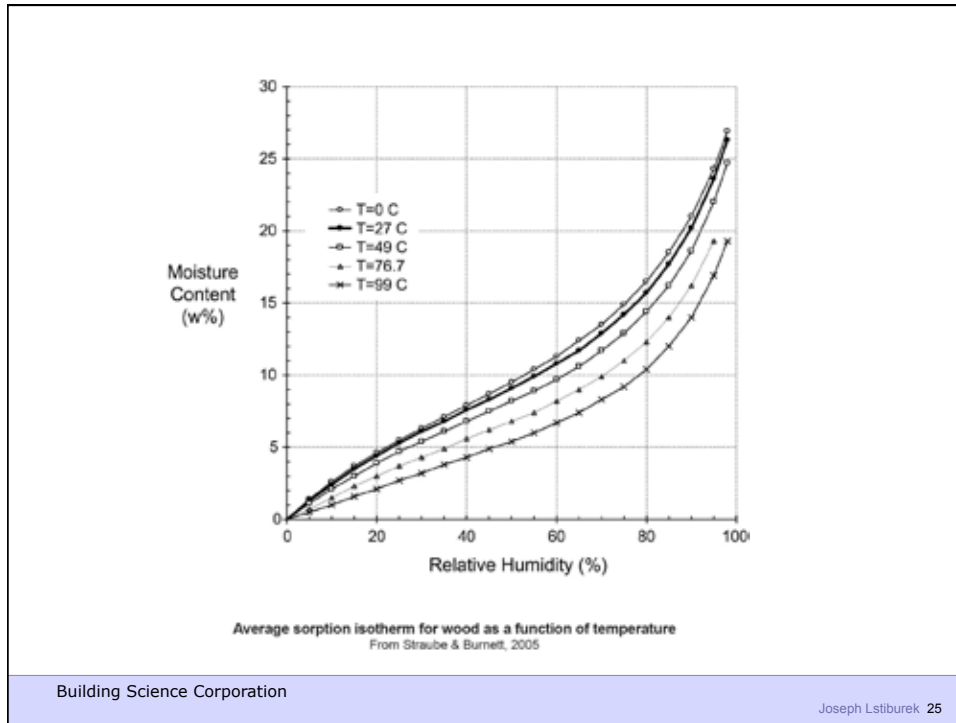

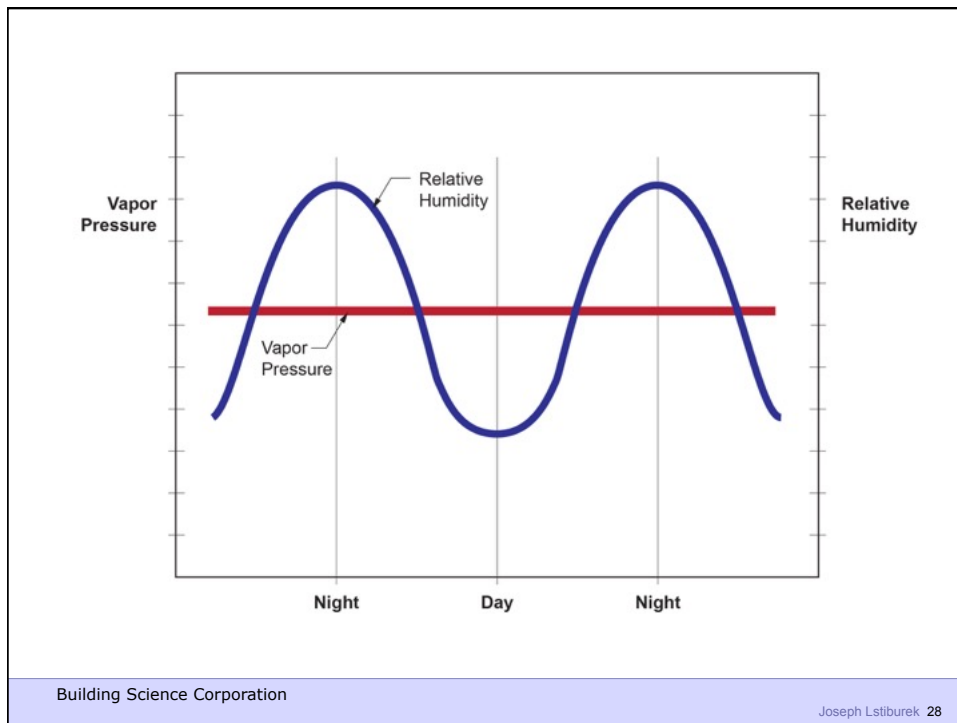
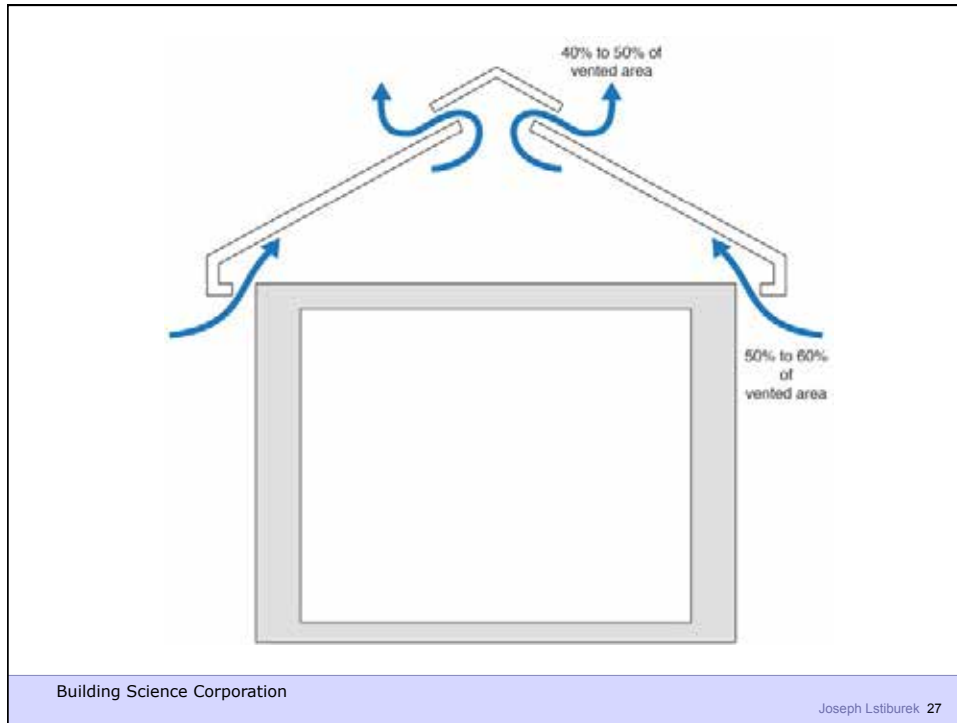

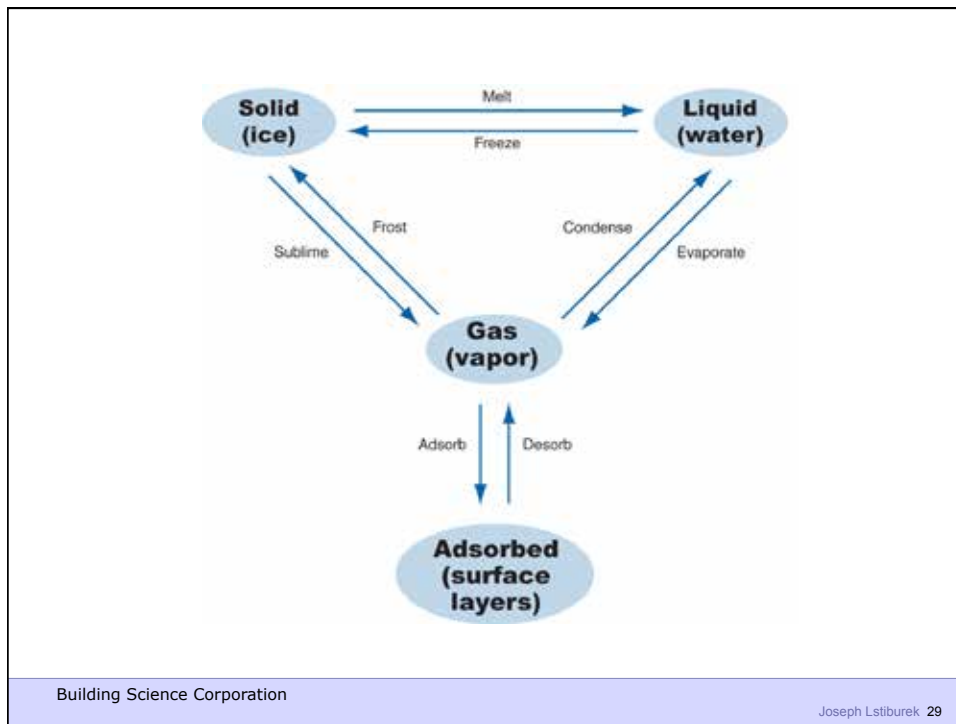

Moisture Transport in Porous Media

Phase	Transport Process	Driving Potential
Vapor	Diffusion	Vapor Concentration
Adsorbate	Surface Diffusion	Concentration
Liquid	Capillary Flow Osmosis	Suction Pressure Solute Concentration

Building Science Corporation Joseph Lstiburek 30

Moisture Transport in Assemblies		
Phase	Transport Process	Driving Potential
Vapor	Diffusion	Vapor Concentration
	Convective Flow	Air Pressure
Adsorbate	Surface Diffusion	Concentration
Liquid	Capillary Flow	Suction Pressure
	Osmosis	Solute Concentration
	Gravitational Flow	Height
	Surface Tension	Surface Energy
	Momentum	Kinetic Energy
	Convective Flow	Air Pressure

Building Science Corporation Joseph Lstiburek 31

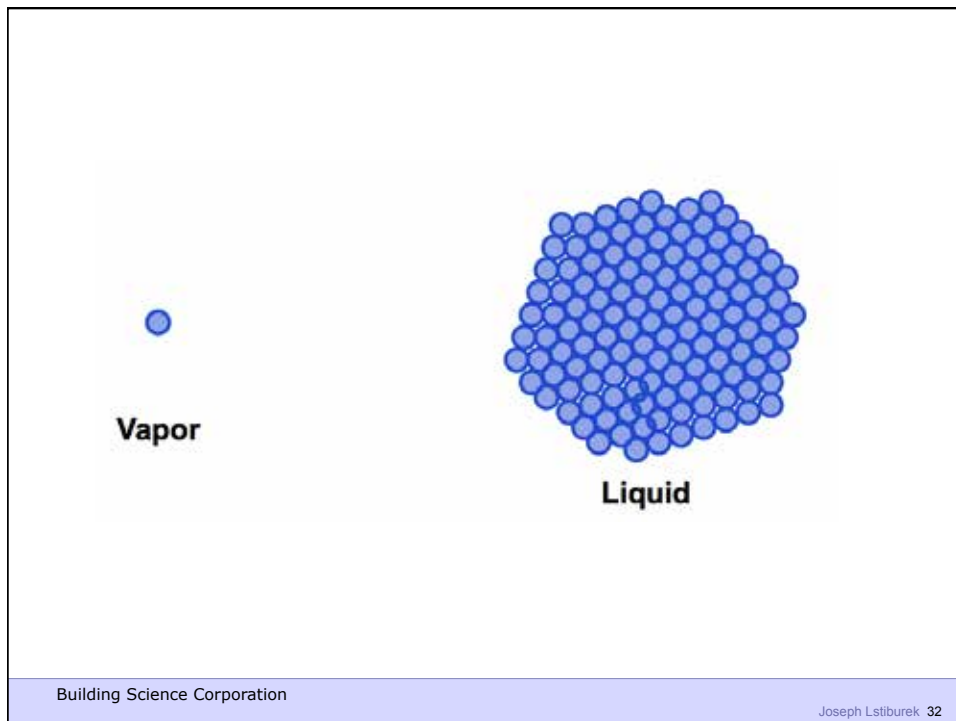

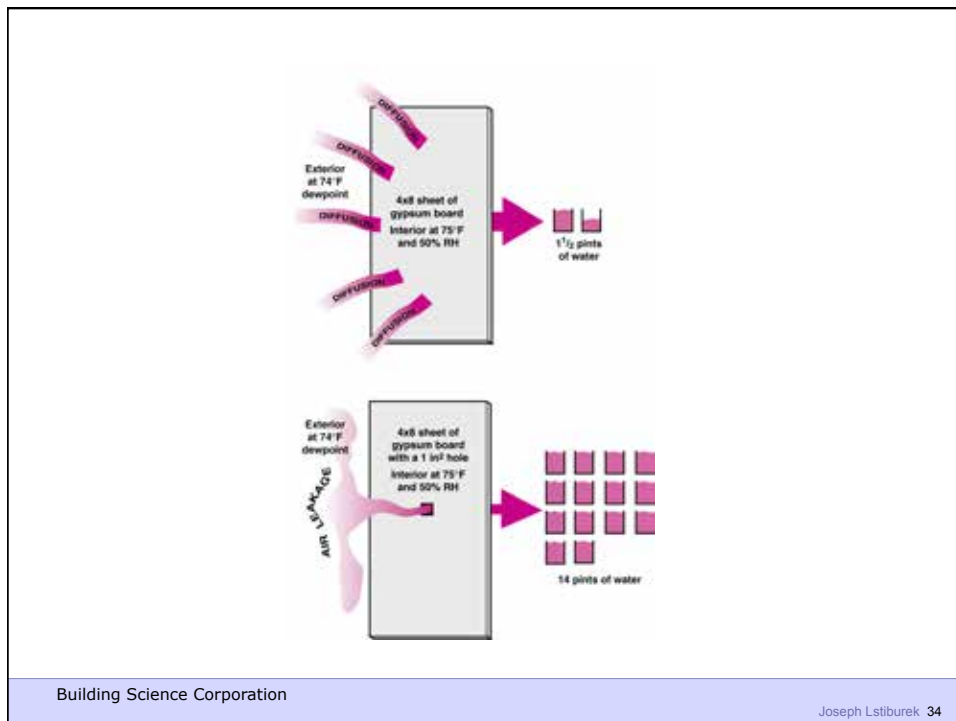
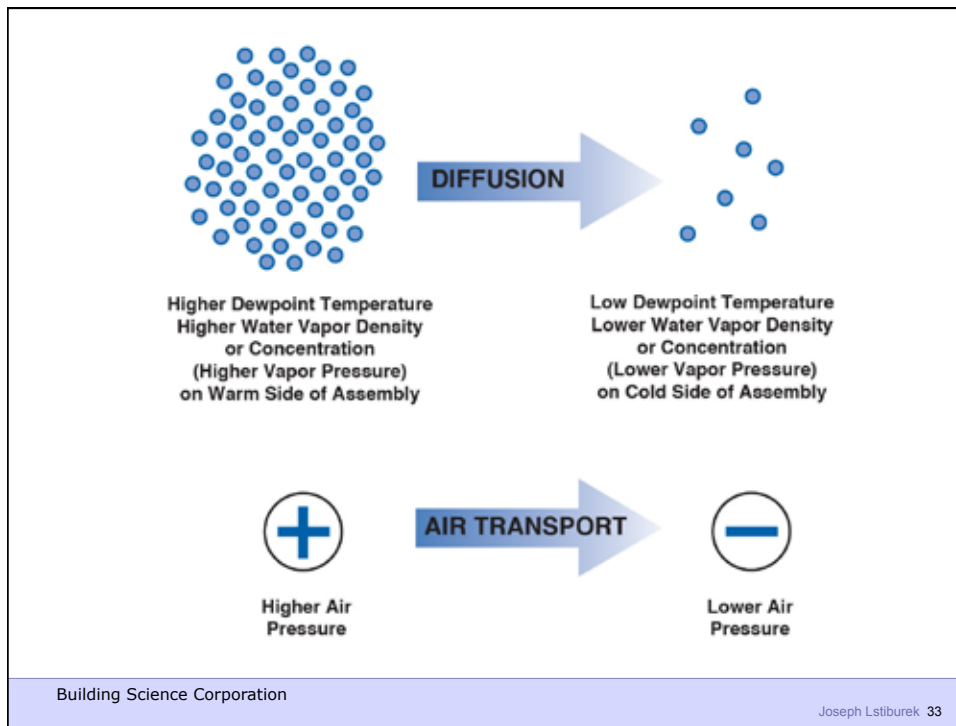

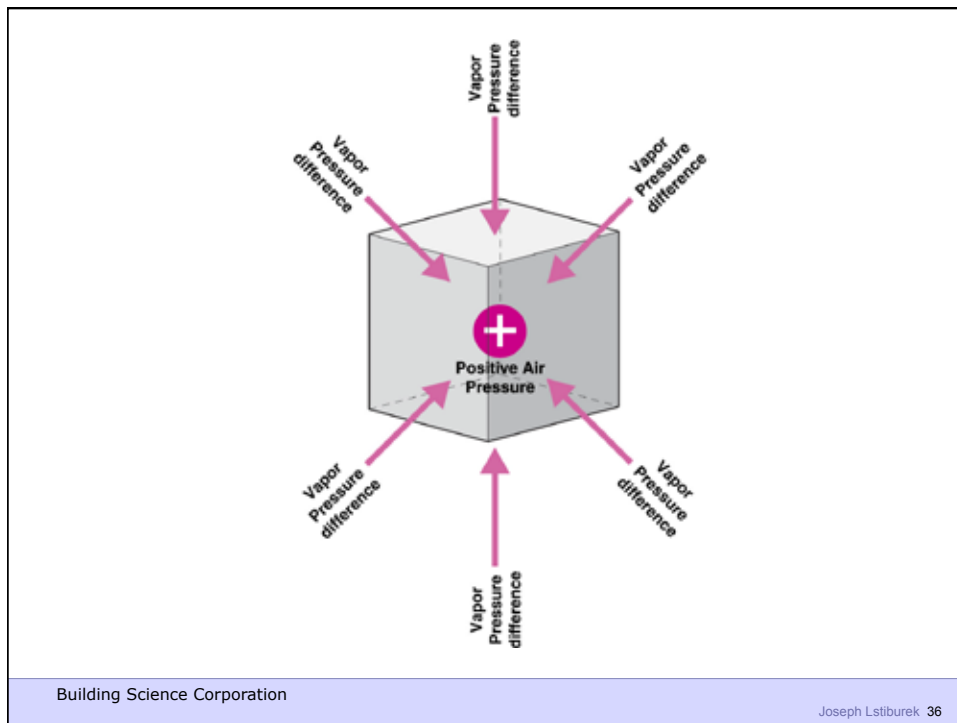
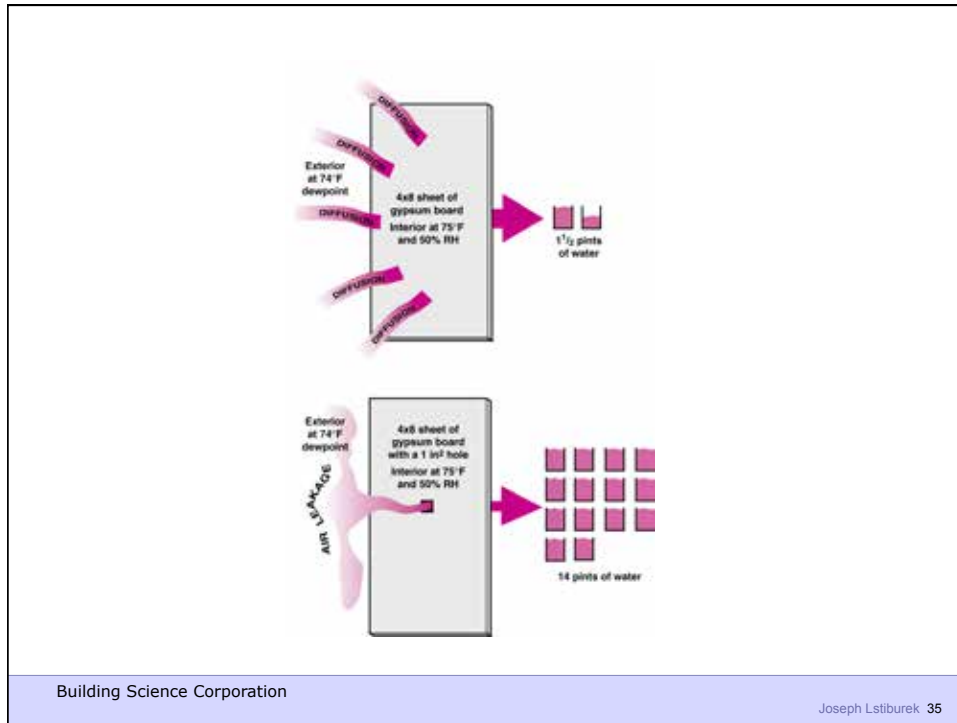

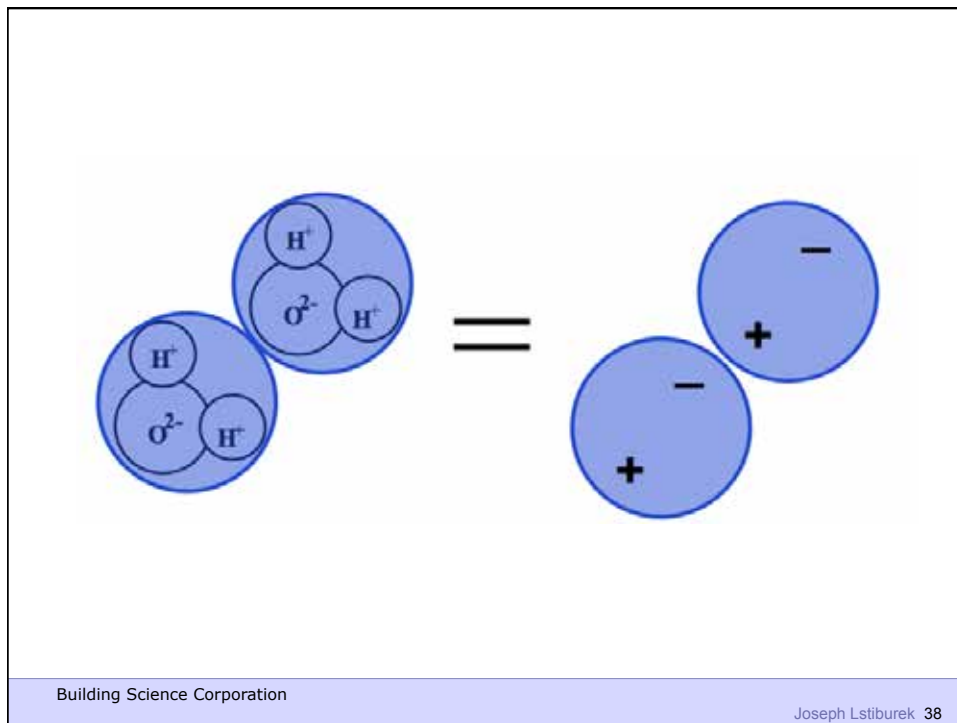
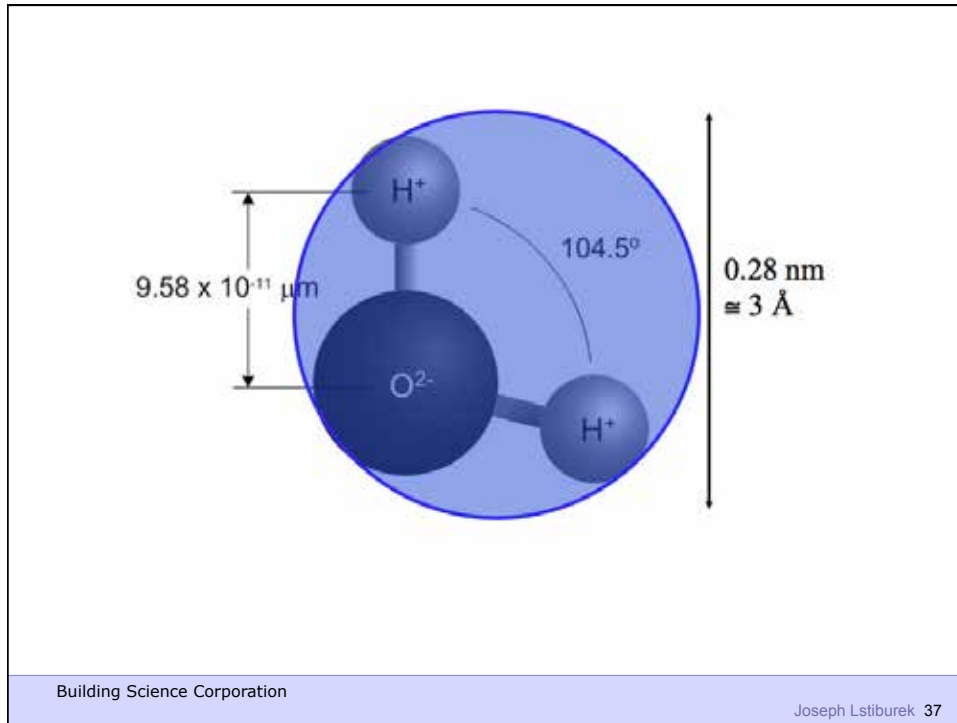

A diagram showing a network of water molecules. Each water molecule is represented by a large black sphere (oxygen) and two smaller grey spheres (hydrogen) bonded to it. Dashed lines connect the oxygen atoms of adjacent water molecules, forming a hexagonal lattice. A double-headed arrow indicates the distance between two oxygen atoms, labeled as $4.5 \times 10^{-10} \mu\text{m}$.

Building Science Corporation Joseph Lstiburek 39

Two diagrams illustrating contact angles. The left diagram shows a blue water droplet on a horizontal surface, with a large contact angle θ indicated by a red arc. The right diagram shows a blue water droplet on a horizontal surface, with a small contact angle θ indicated by a red arc.

<ul style="list-style-type: none"> • "non-wettable" surface • water repellent surface • hydrophobic surface • water more attracted to itself than to surface • surface energy of water greater than surface energy of surface • water "beads up" • "greasy" surface • high contact angle "θ" 	<ul style="list-style-type: none"> • "wettable" surface • non-water repellent surface • hydroscopic surface • water more attracted to surface than itself • surface energy of surface greater than surface energy of water • water "spreads out" • "non-greasy" surface • low contact angle "θ"
--	---

Building Science Corporation Joseph Lstiburek 40

Calculating capillary rise

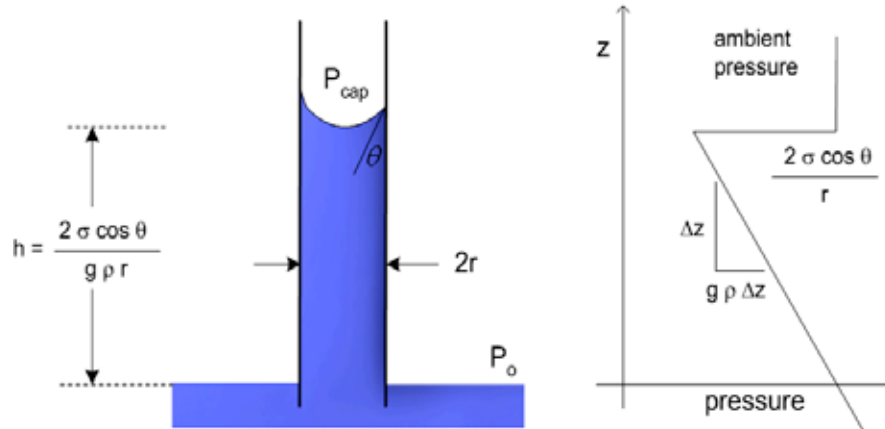

Building Science Corporation

Capillary rise versus diameter

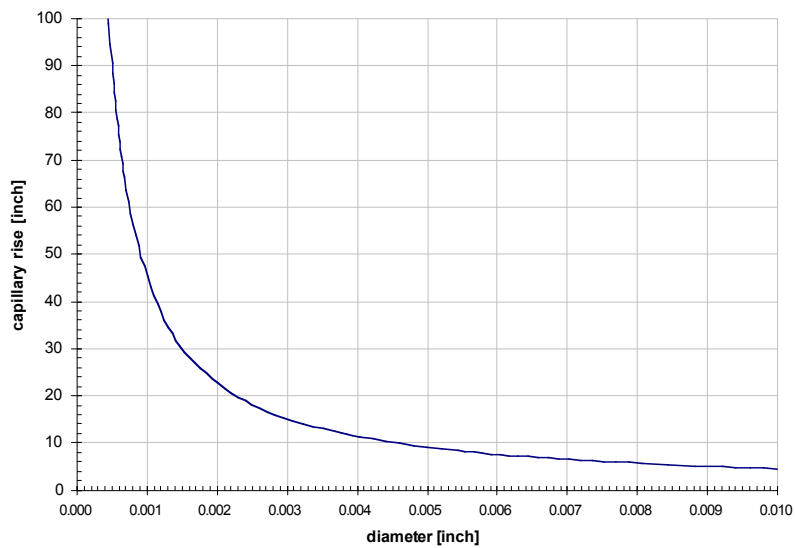

Building Science Corporation

Heat
Air
Moisture

HAM

Hygrothermal Analysis

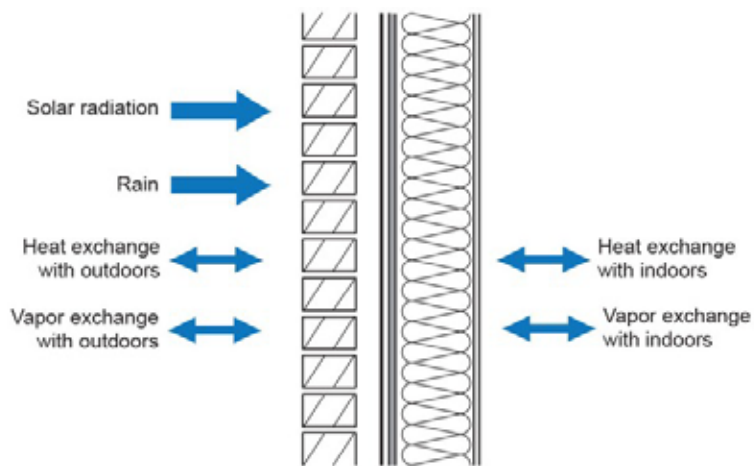

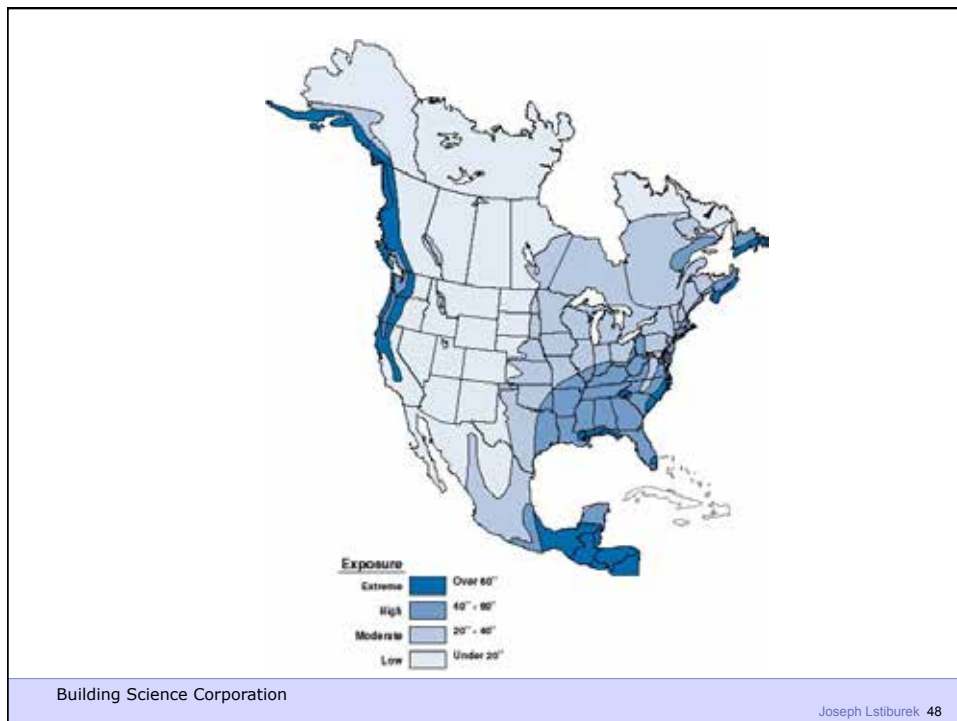
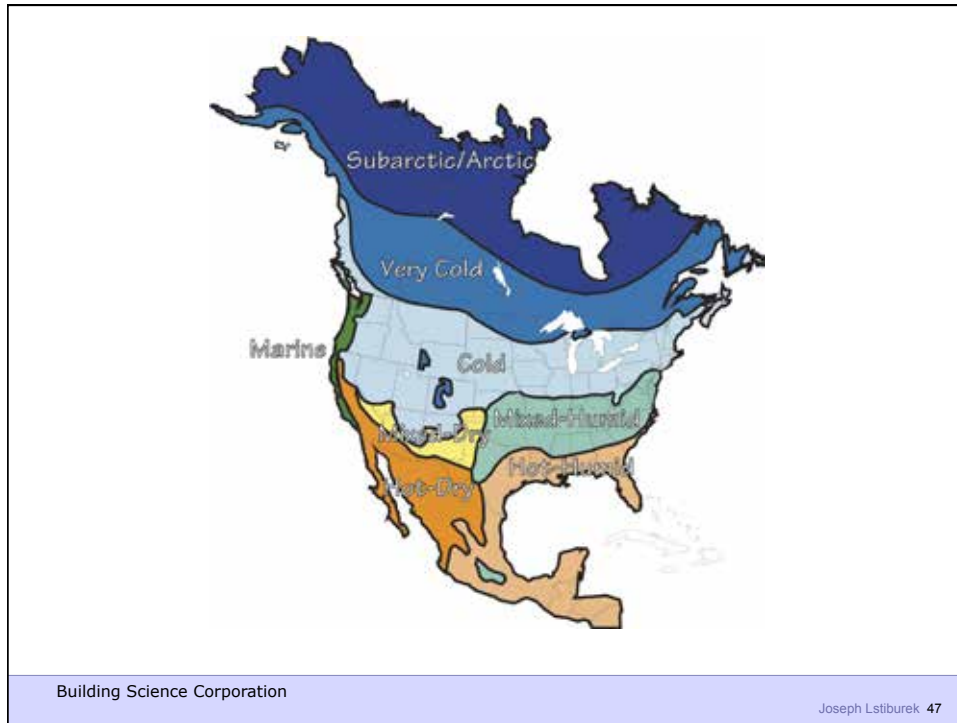

Don't Do Stupid Things

Building Science Corporation

Joseph Lstiburek 49



Building Science Corporation

Joseph Lstiburek 50



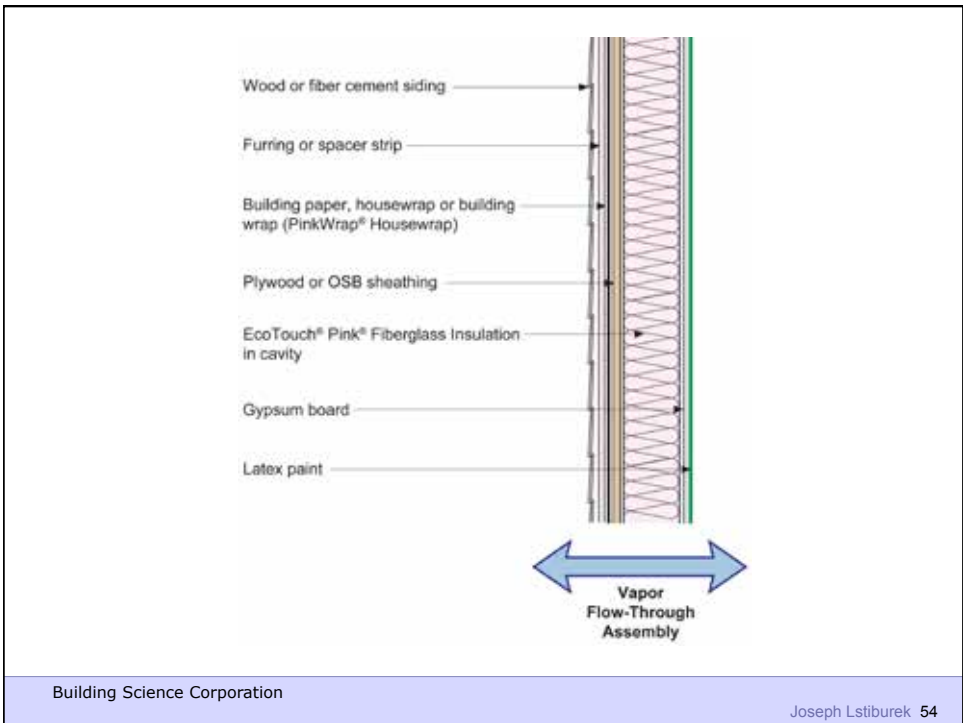

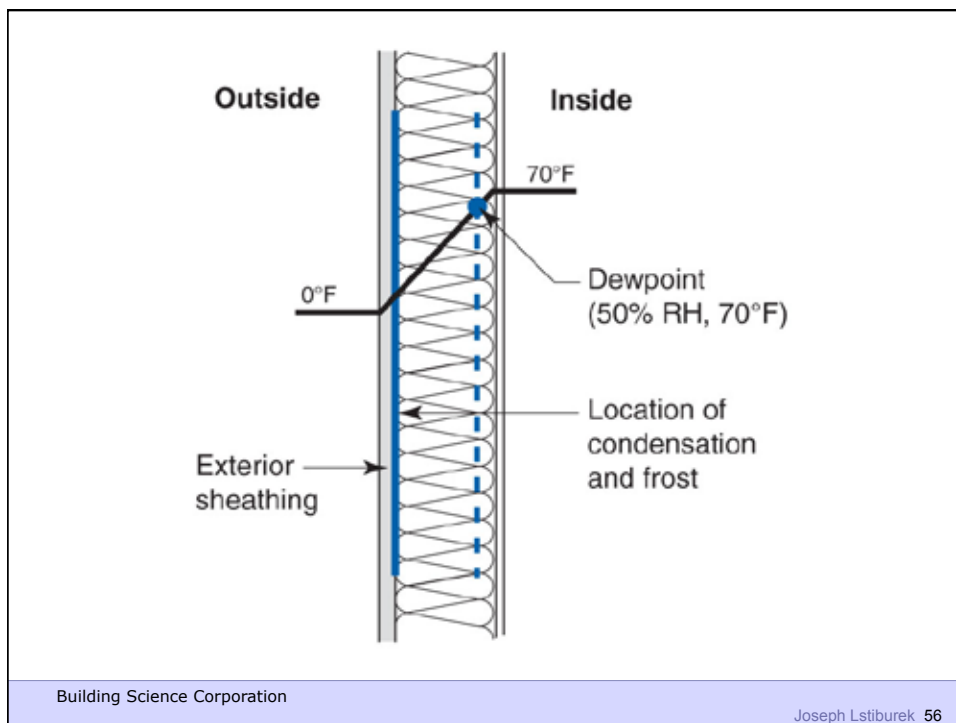
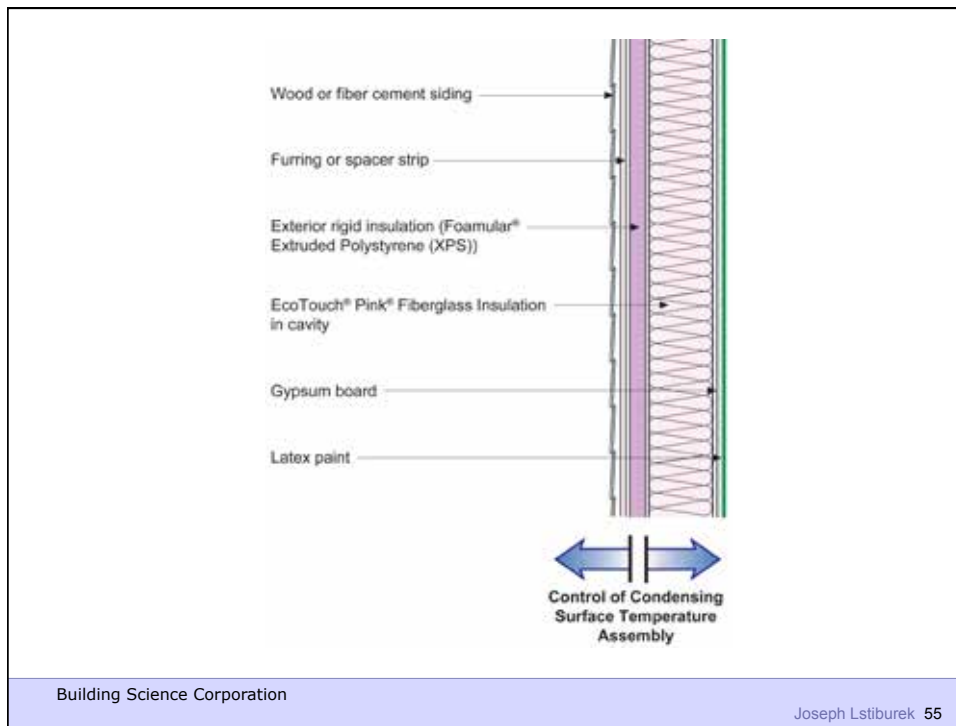



Building Science Corporation

Joseph Lstiburek 57



Building Science Corporation

Joseph Lstiburek 58

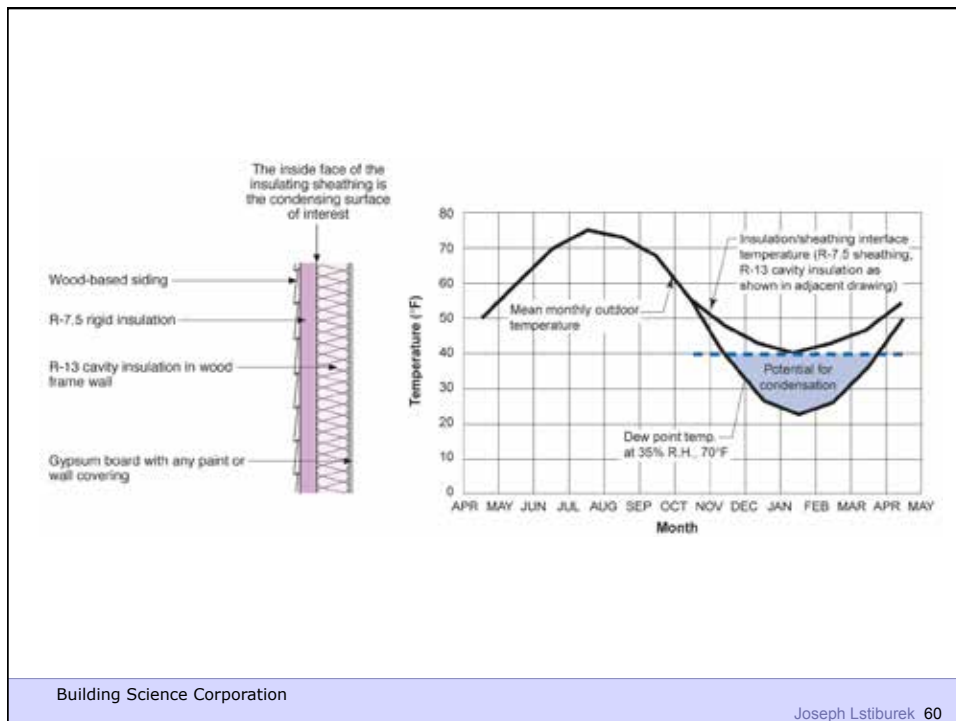
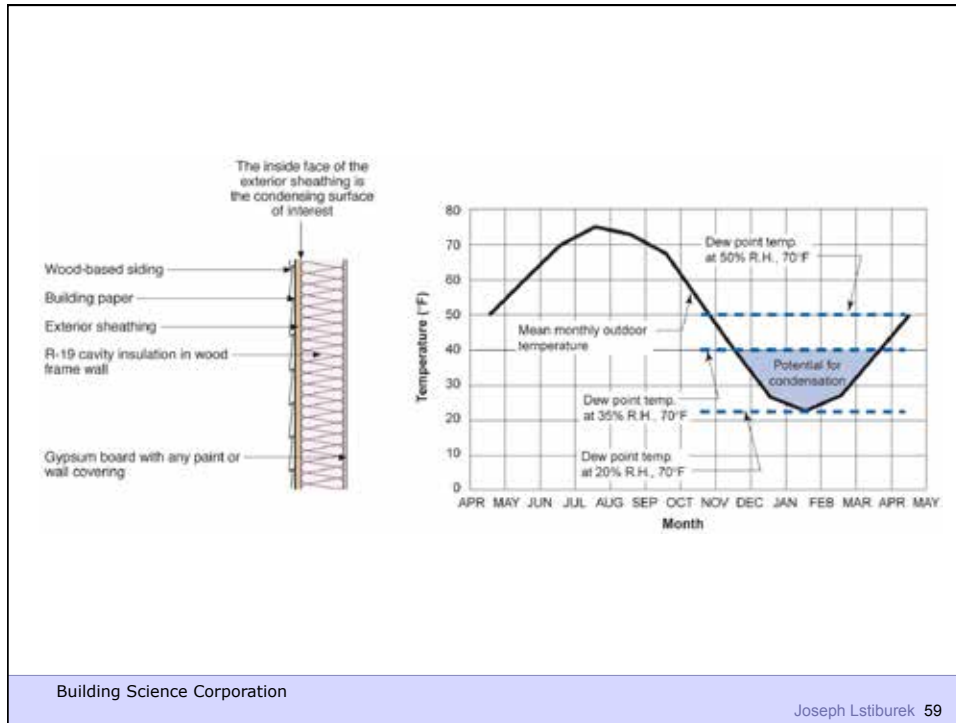

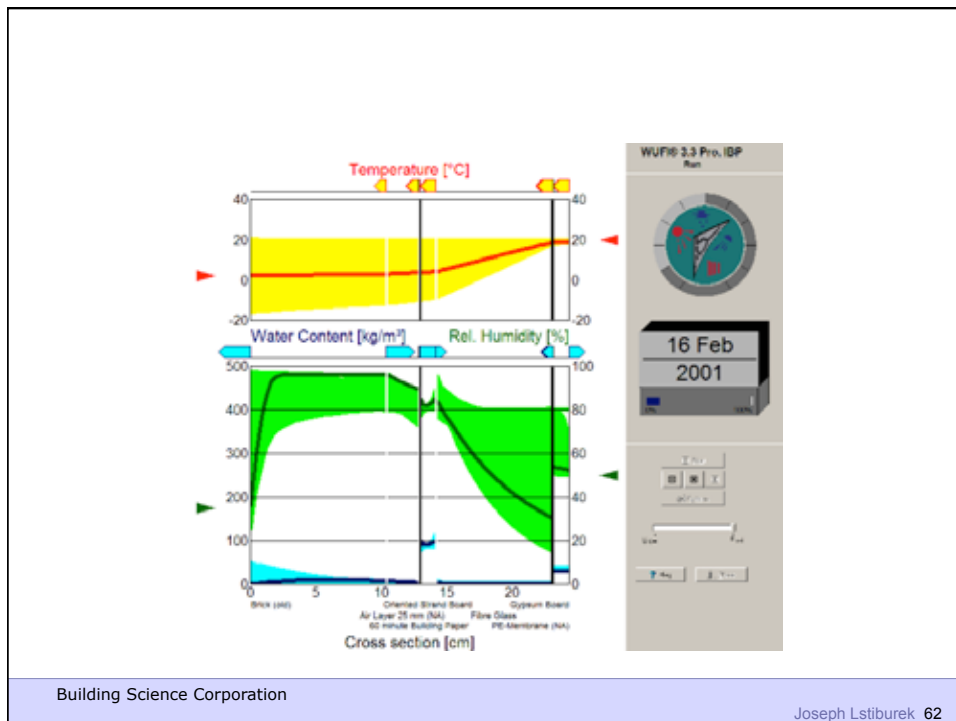
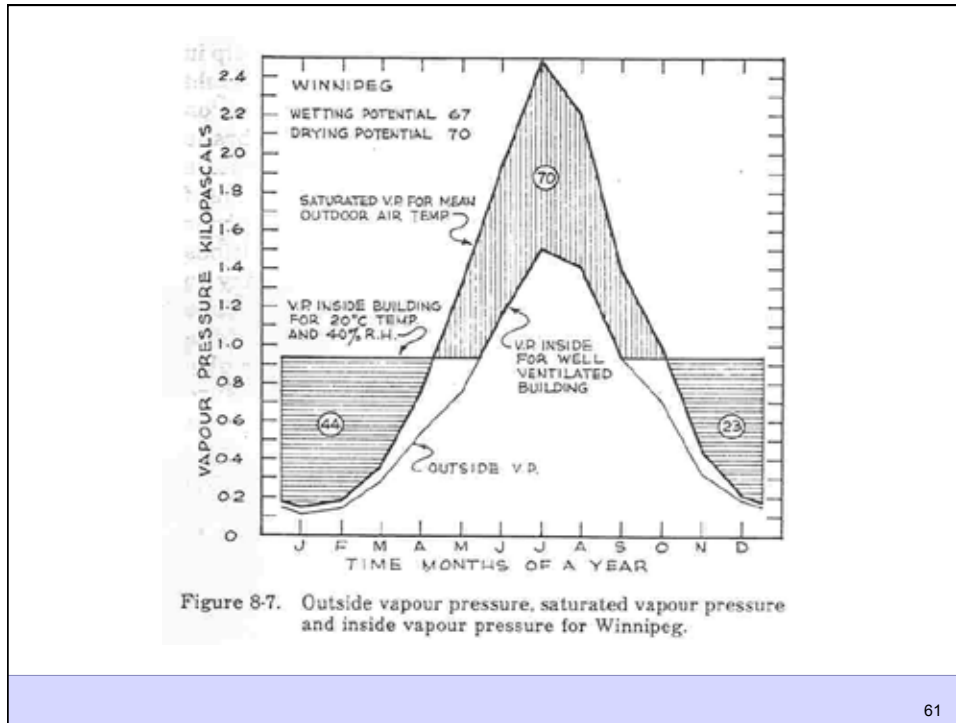

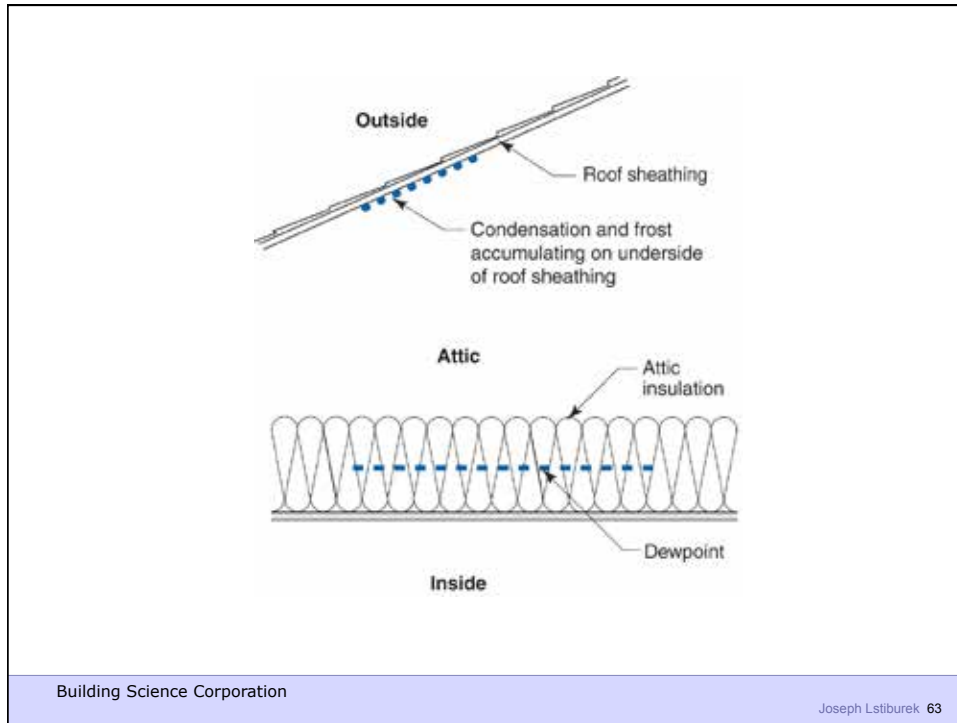

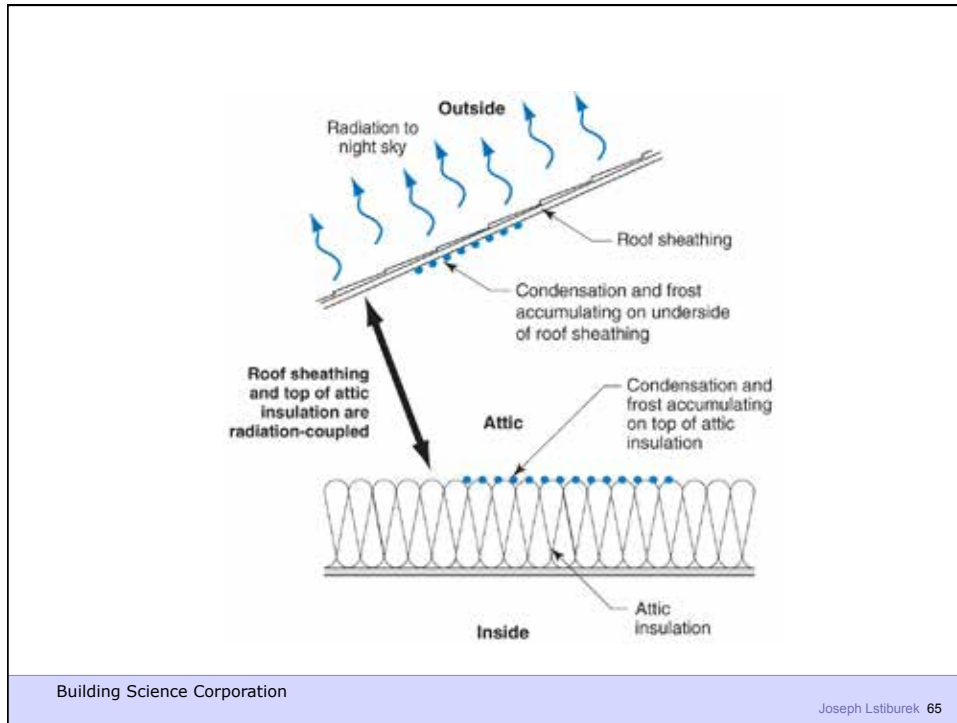

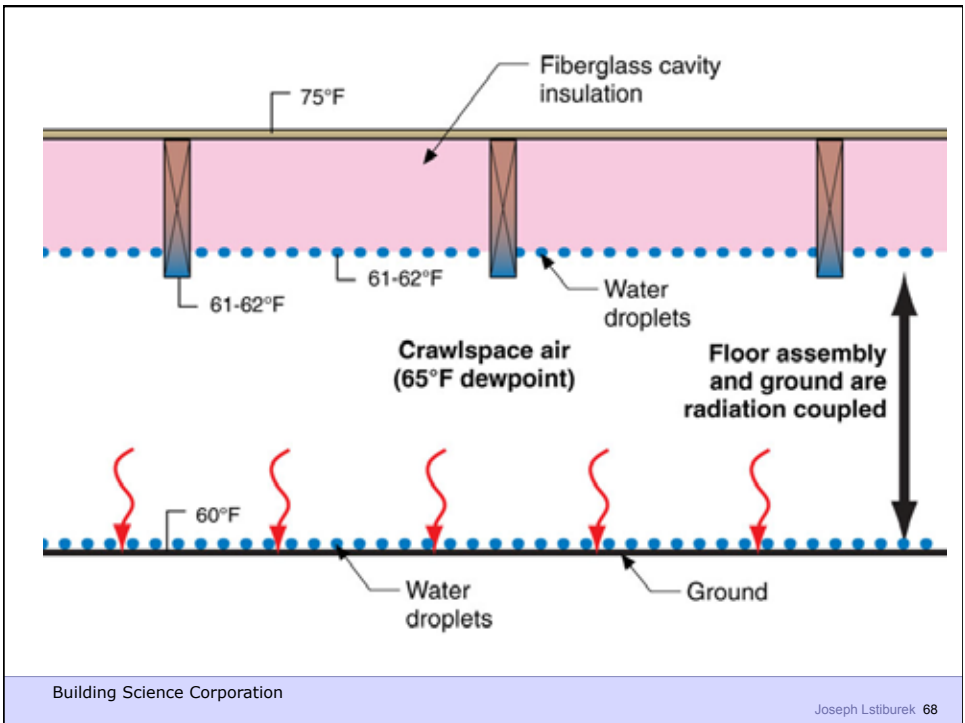

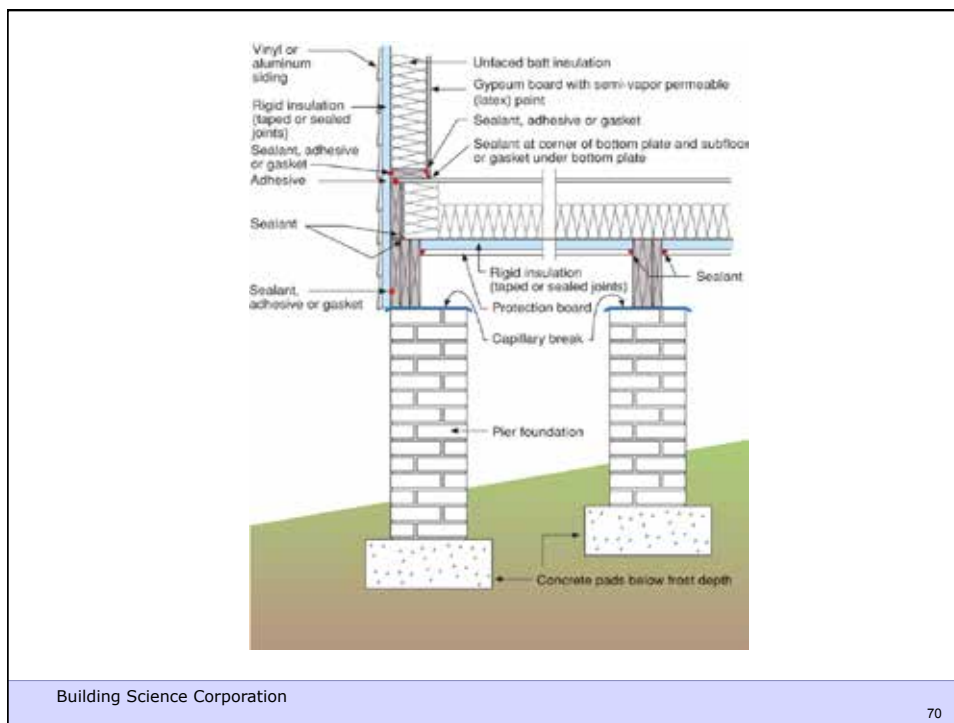
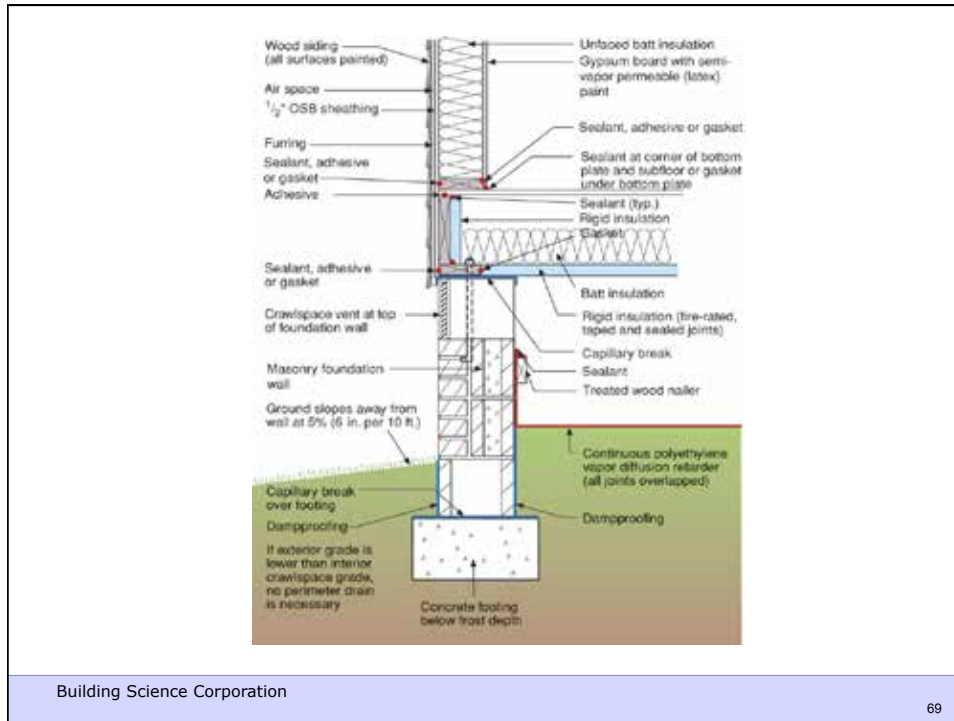

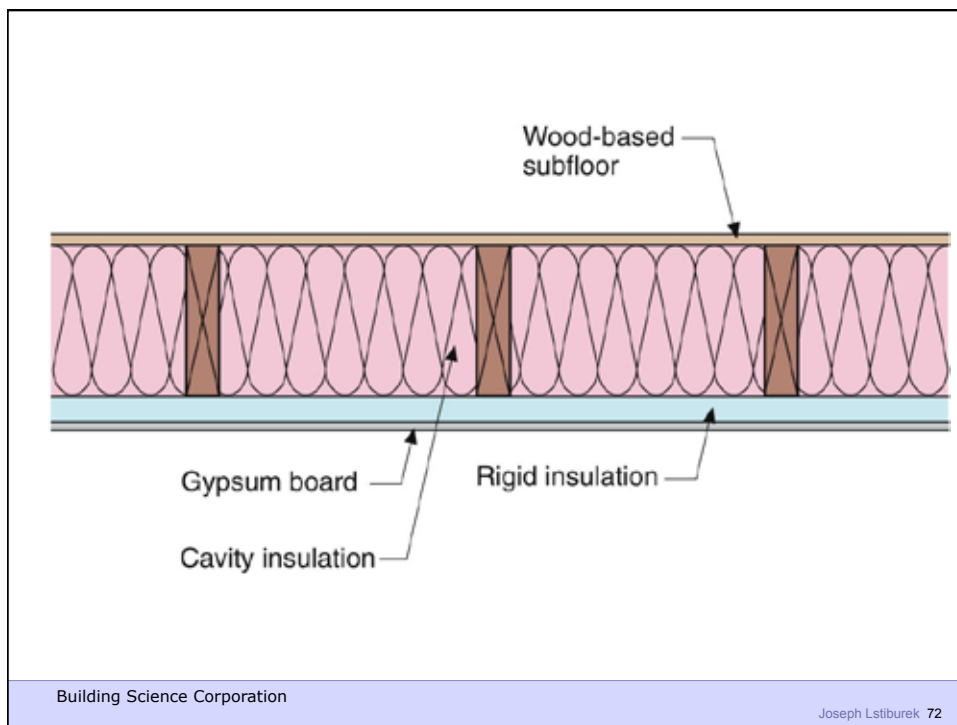
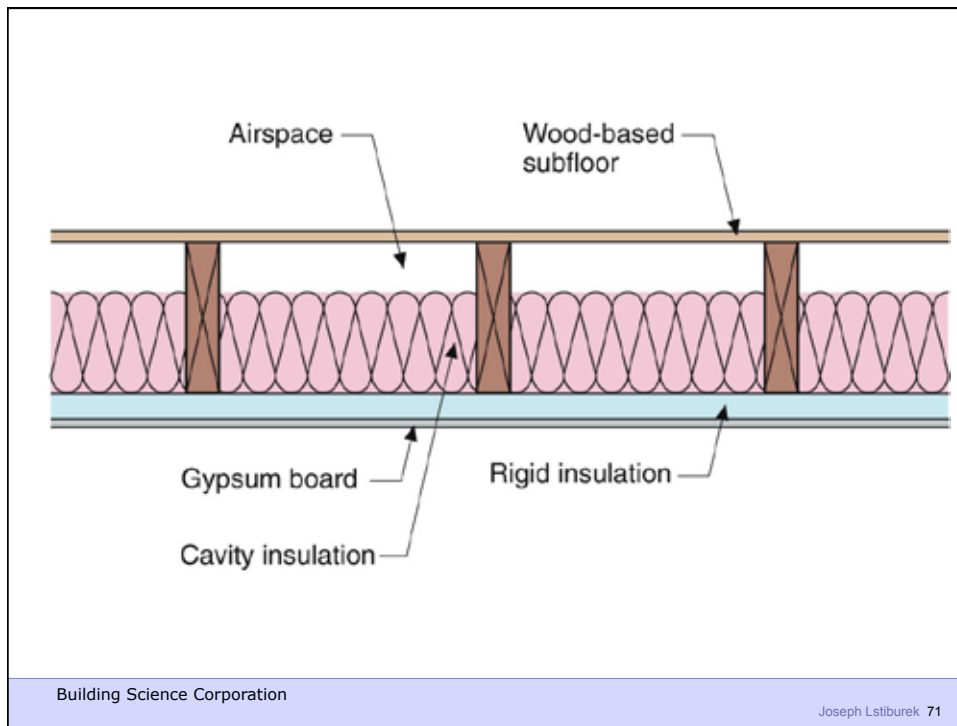

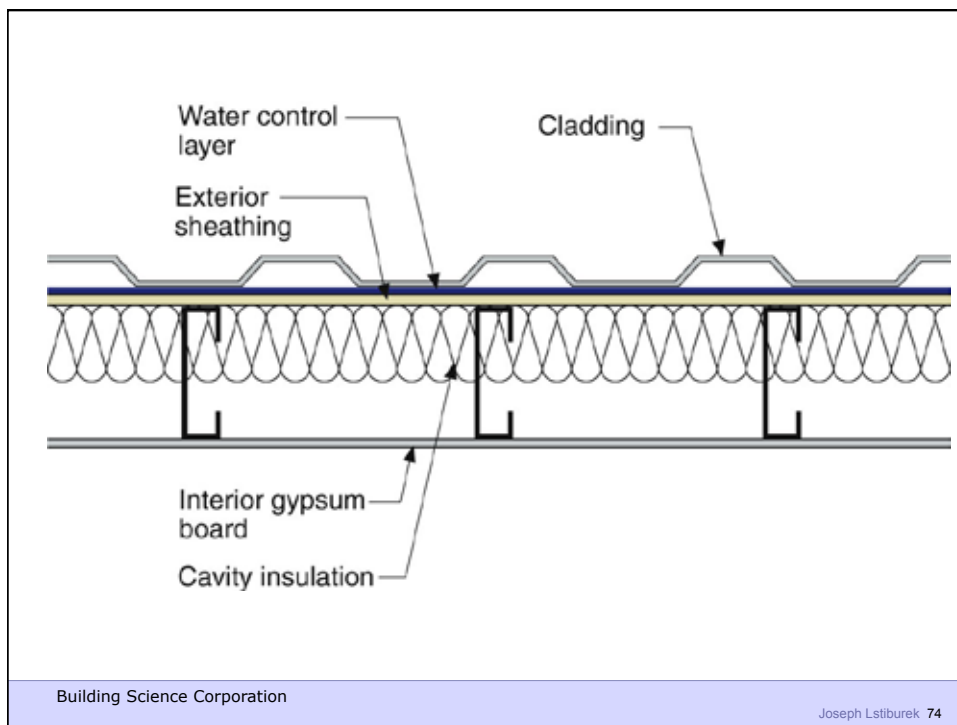
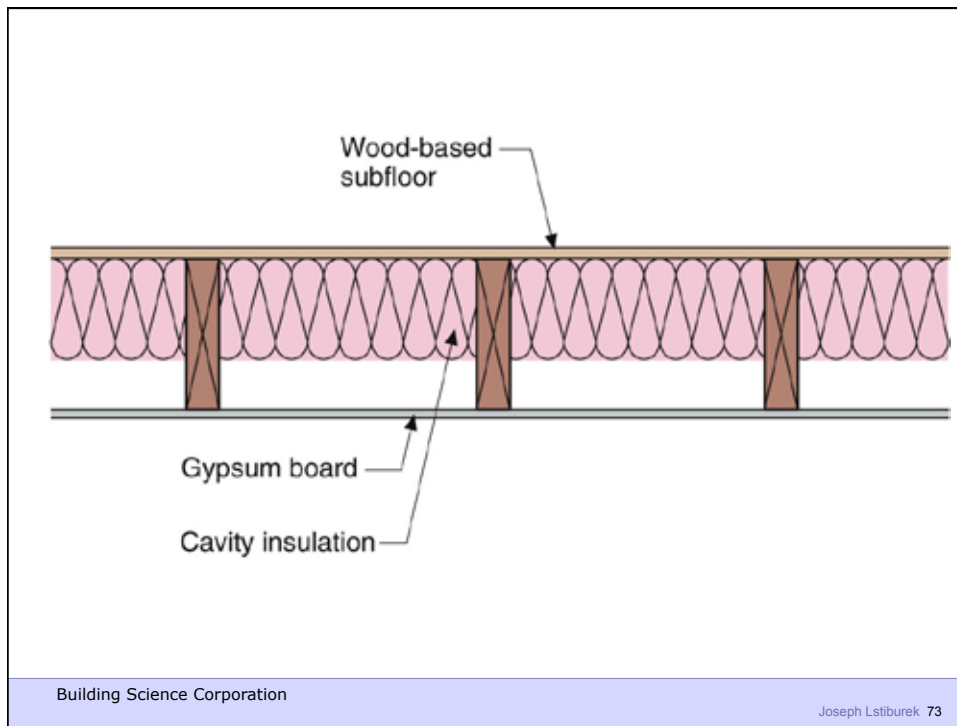

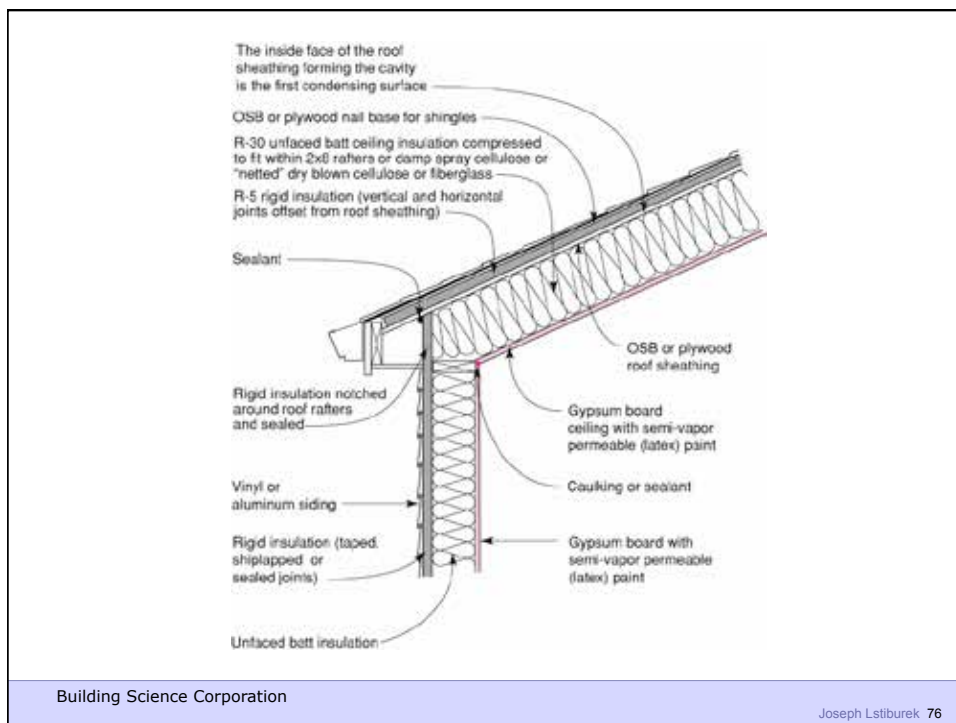
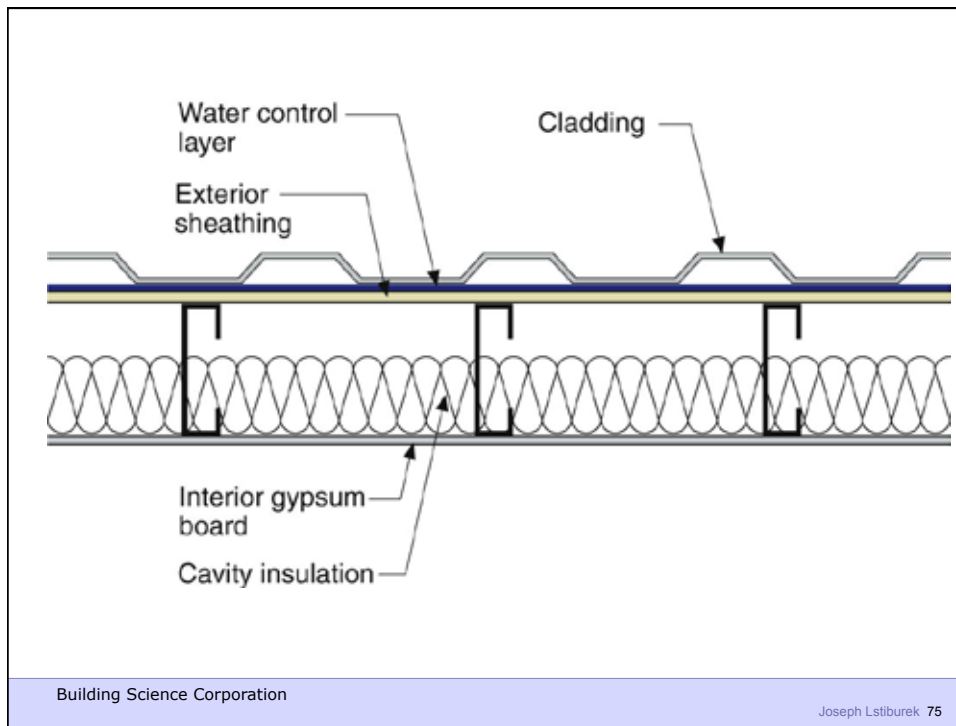

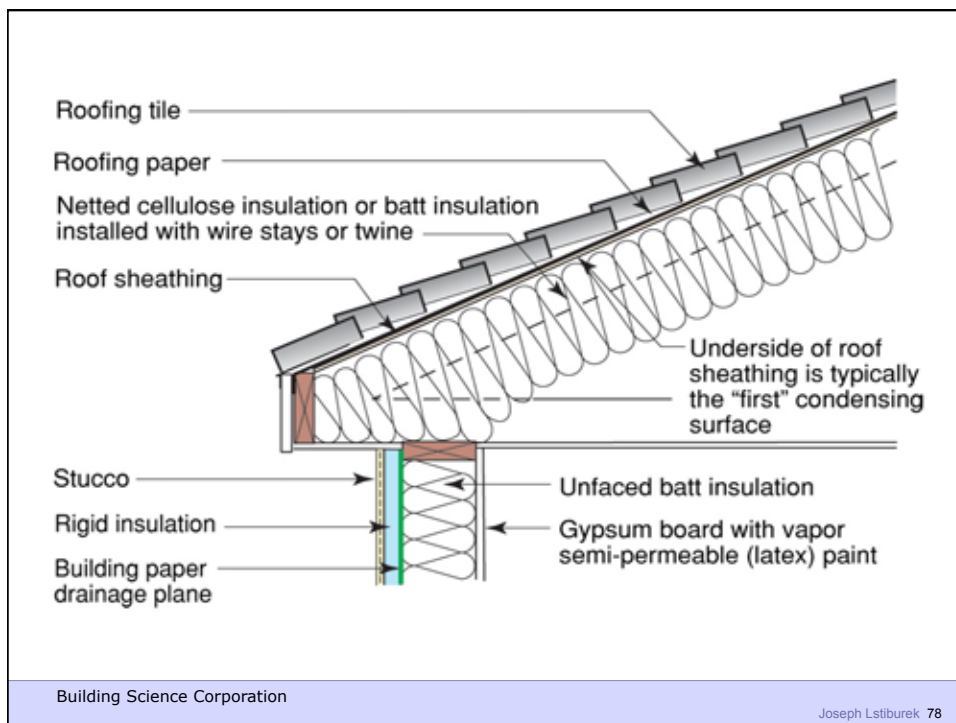
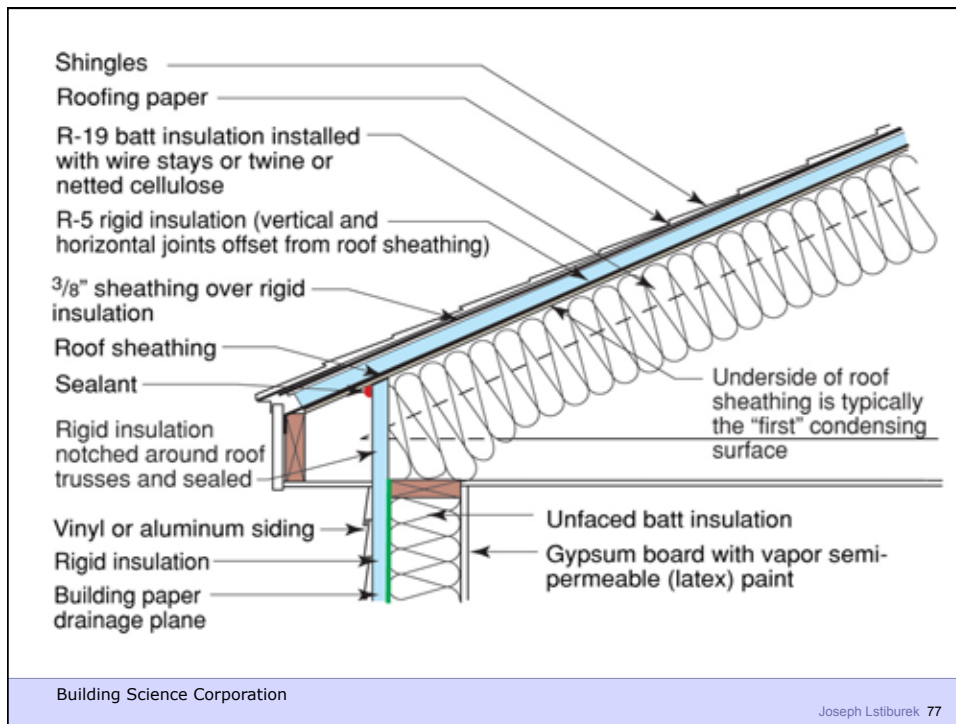

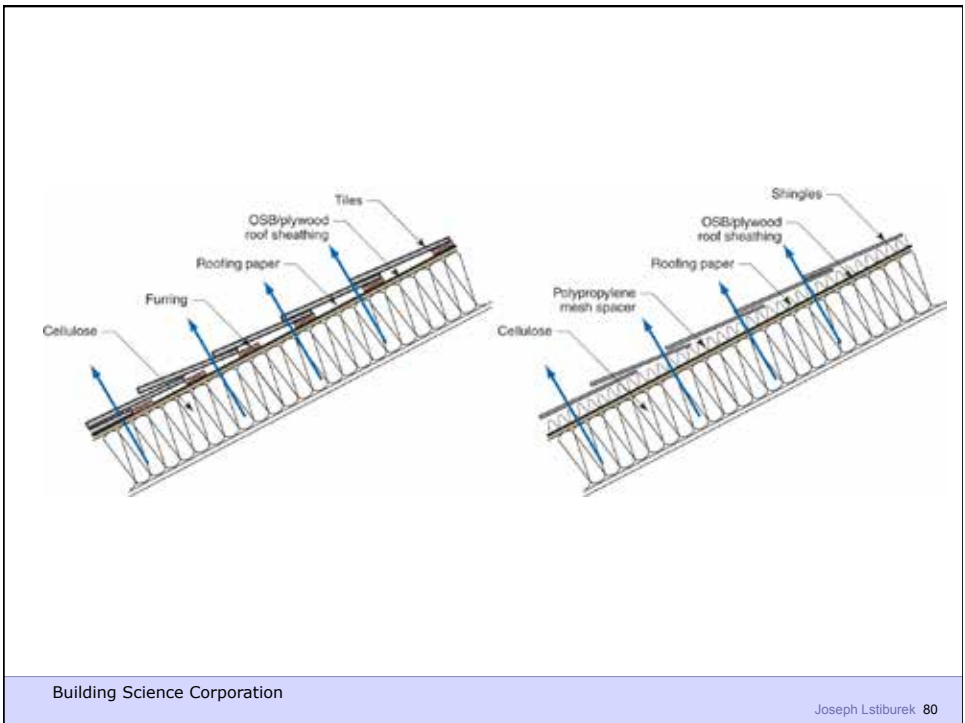

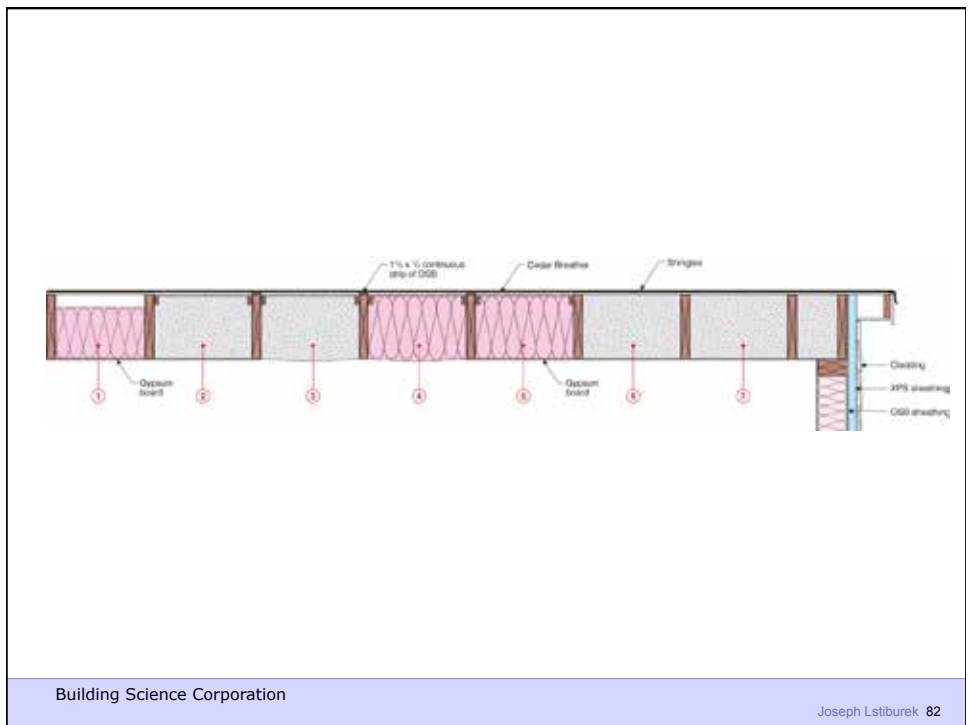
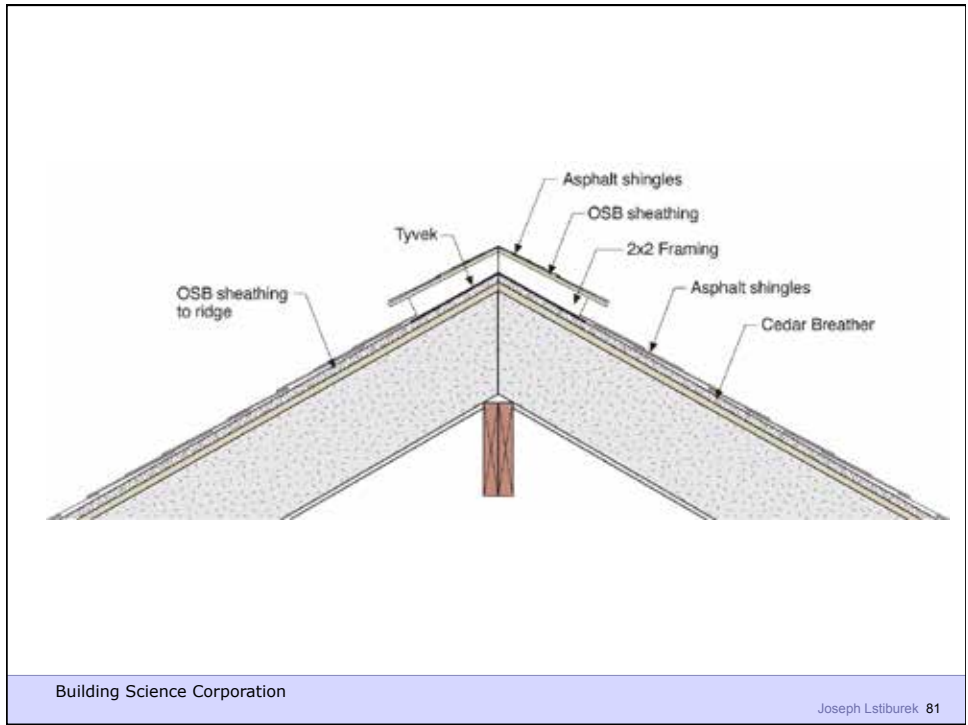



Building Science Corporation

Joseph Lstiburek 83



Building Science Corporation

Joseph Lstiburek 84



Building Science Corporation

Joseph Lstiburek 85



Building Science Corporation

Joseph Lstiburek 86



Building Science Corporation

Joseph Lstiburek 87



Building Science Corporation

Joseph Lstiburek 88

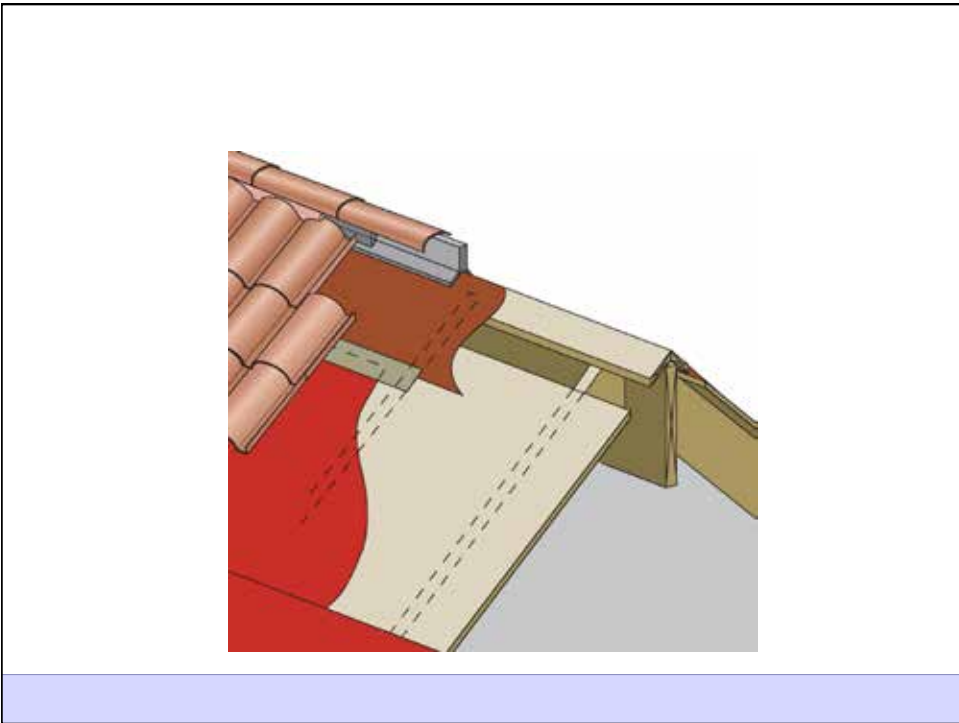
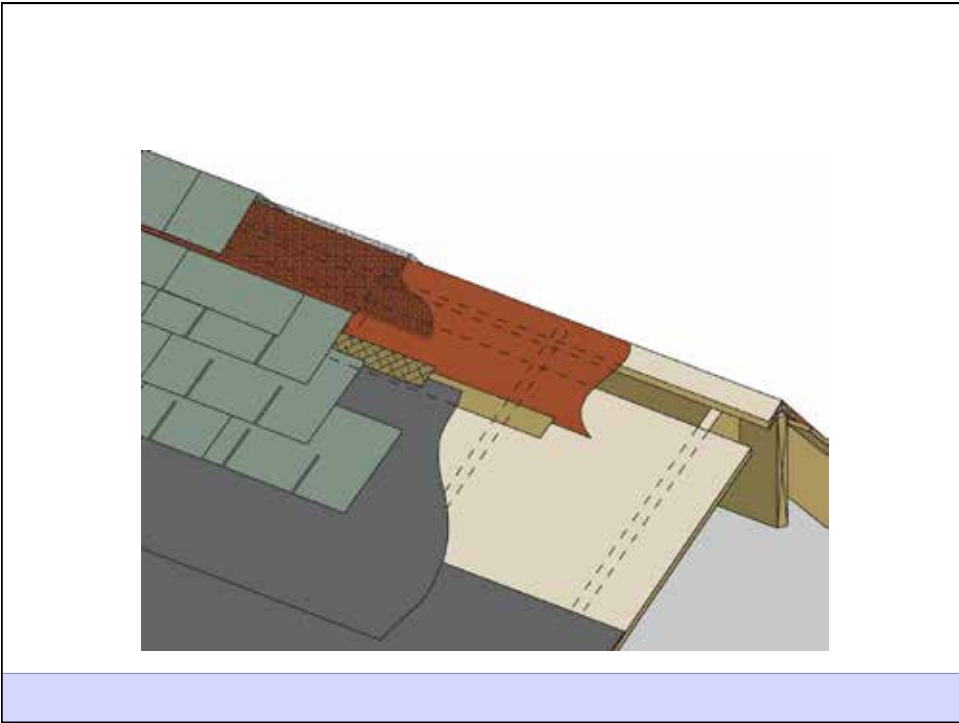



Building Science Corporation

Joseph Lstiburek 91

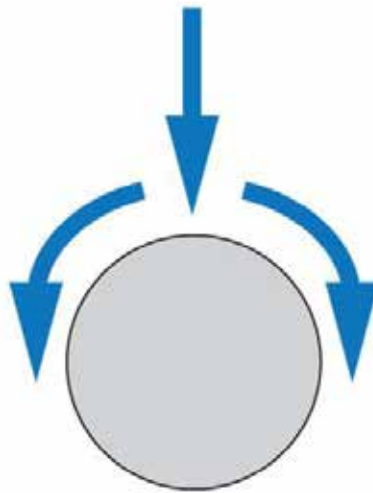

Building Science Corporation

Joseph Lstiburek 92

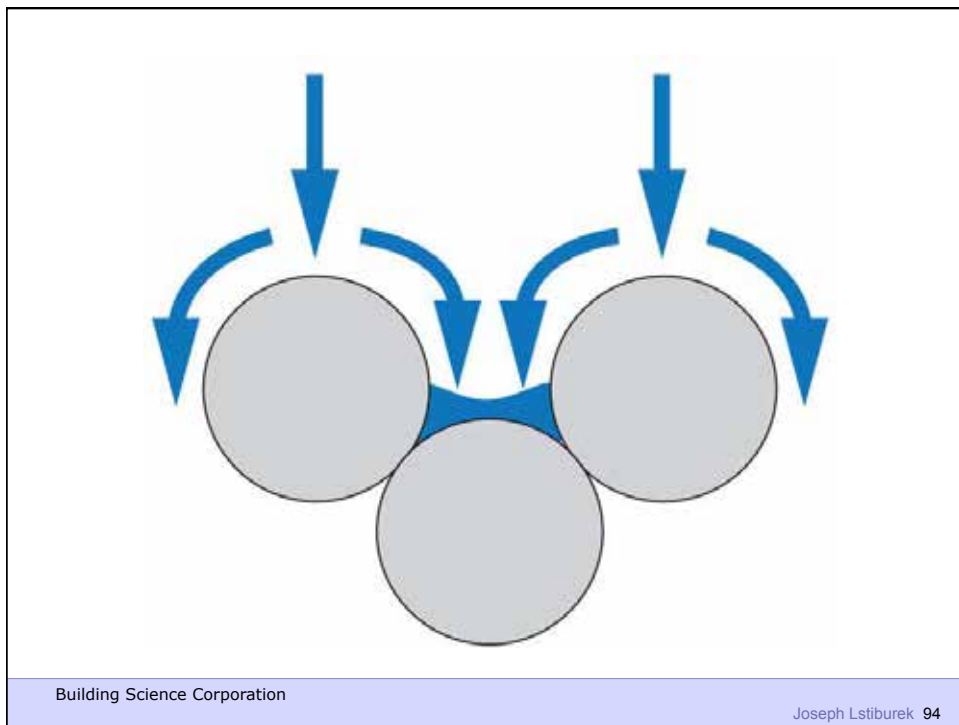
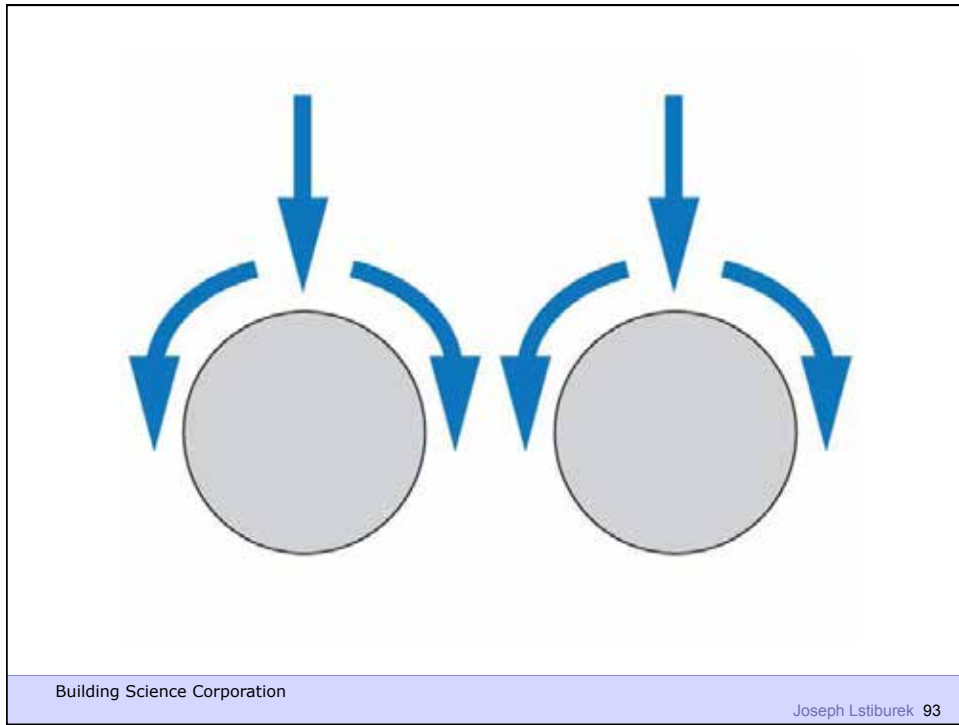

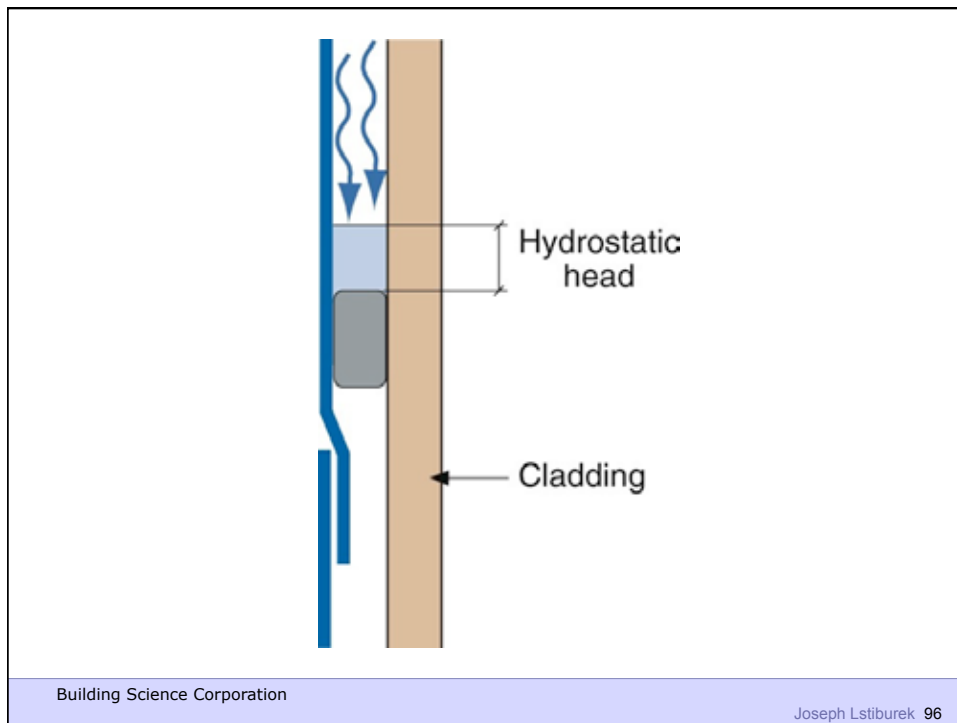
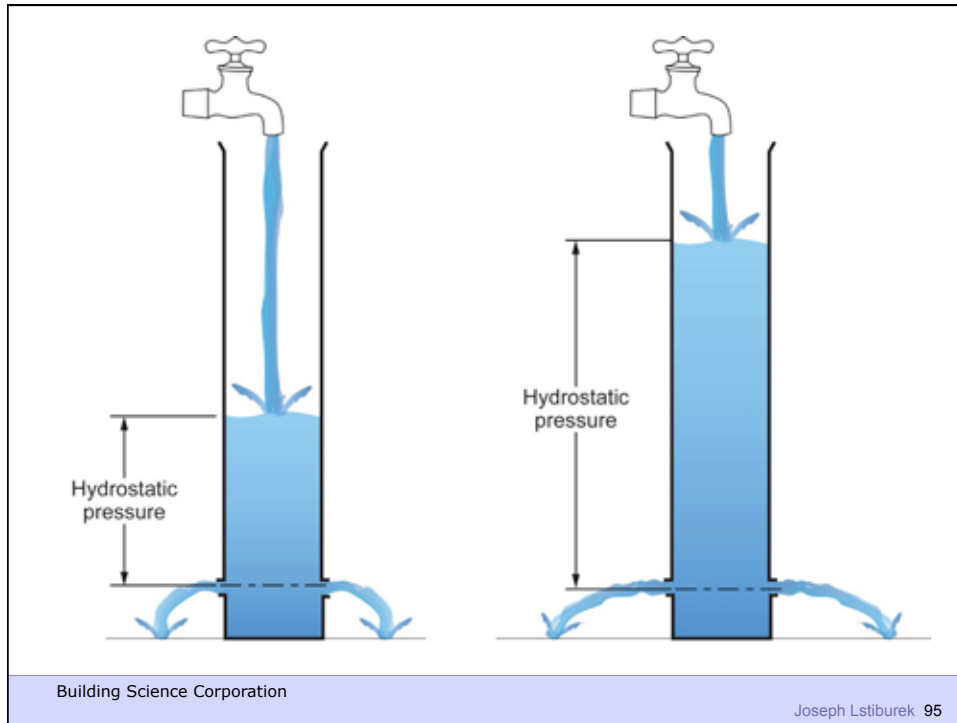



Building Science Corporation

Joseph Lstiburek 97

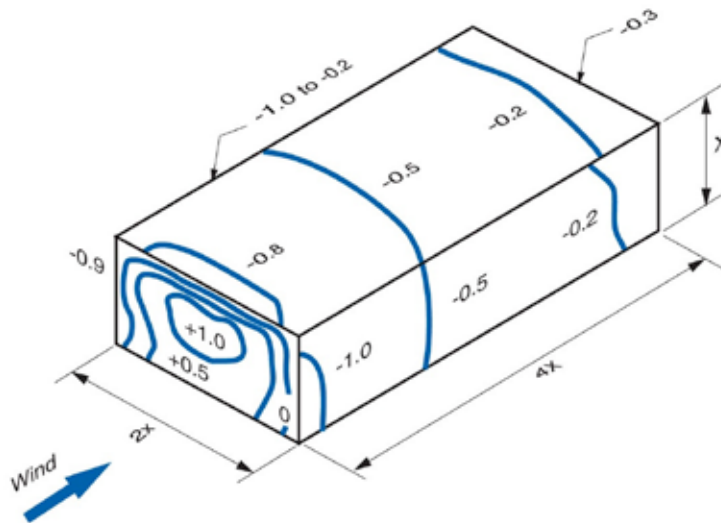

Building Science Corporation

Joseph Lstiburek 98

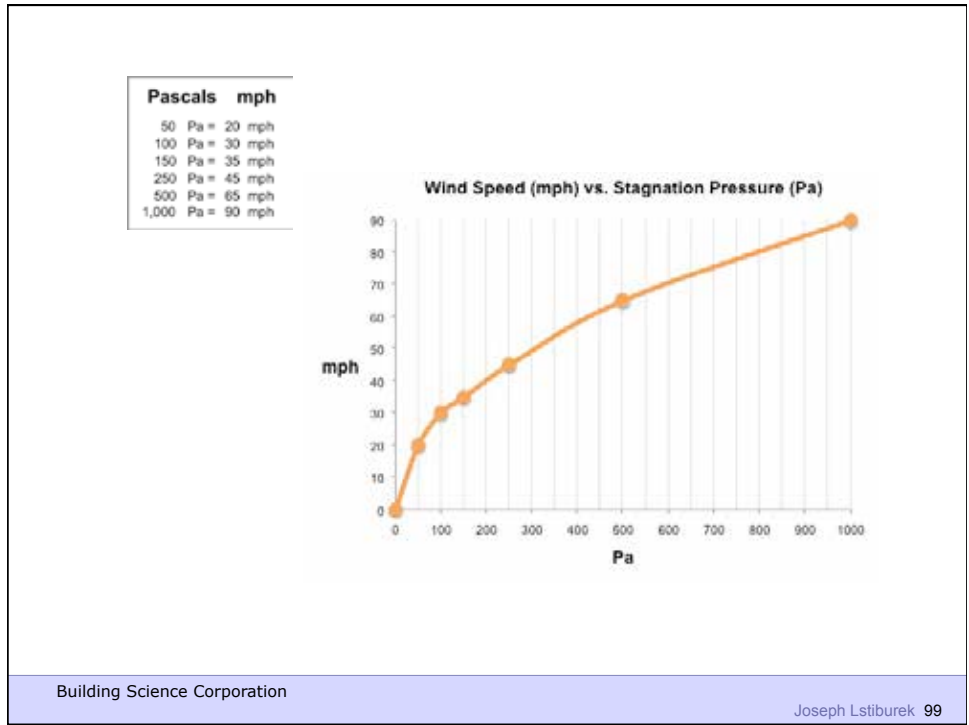



Building Science Corporation

Joseph Lstiburek – Rain Control 101

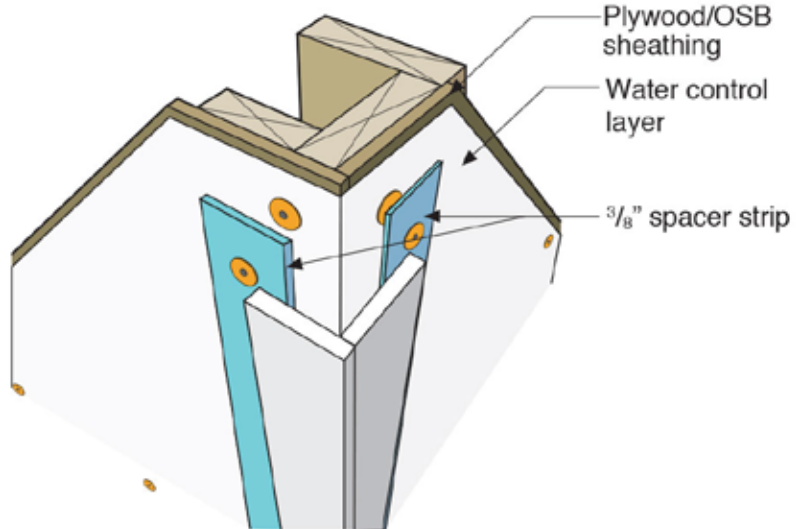

Building Science Corporation

Joseph Lstiburek 102



Building Science Corporation
2010

Joseph Lstiburek 103



Building Science Corporation

Joseph Lstiburek 104



Building Science Corporation

Joseph Lstiburek 105



Building Science Corporation

Joseph Lstiburek 106



Building Science Corporation

Joseph Lstiburek 107



Building Science Corporation

Joseph Lstiburek 108



Building Science Corporation

Joseph Lstiburek 109



Building Science Corporation

Joseph Lstiburek 110



Building Science Corporation

Joseph Lstiburek 111

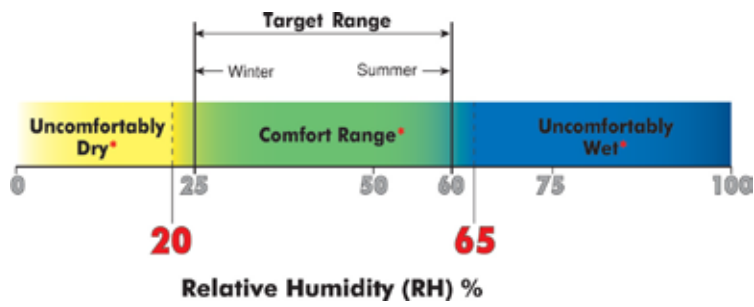

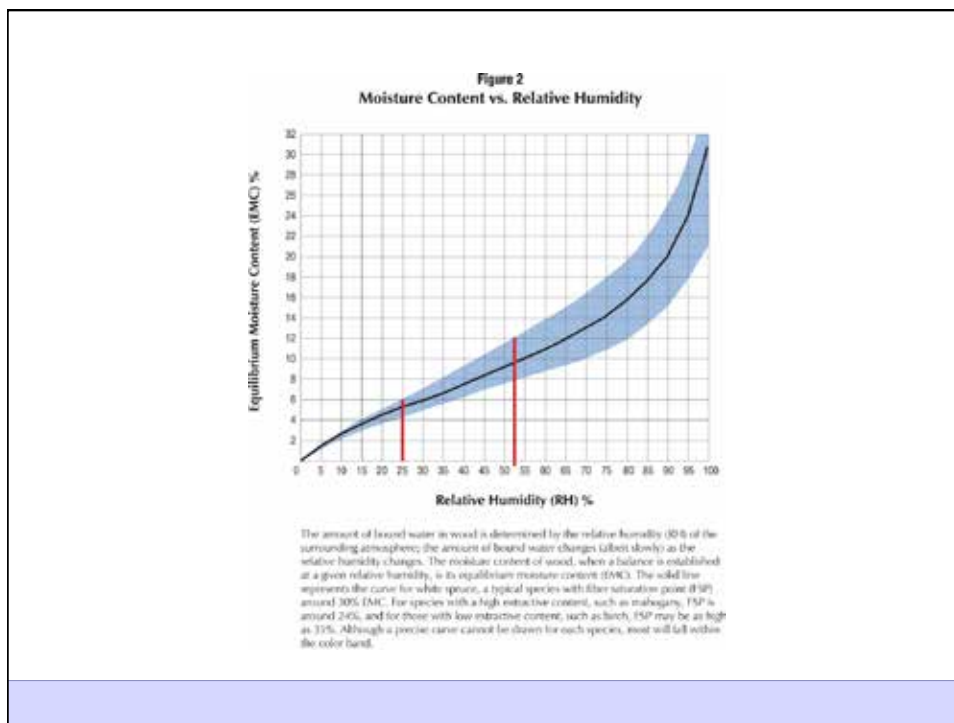
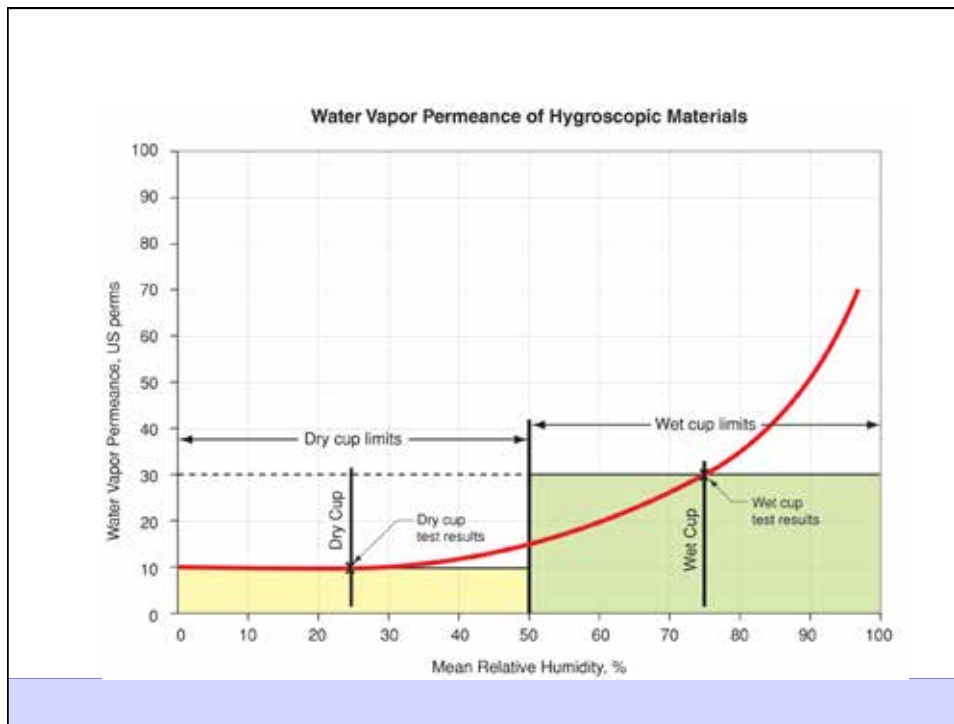



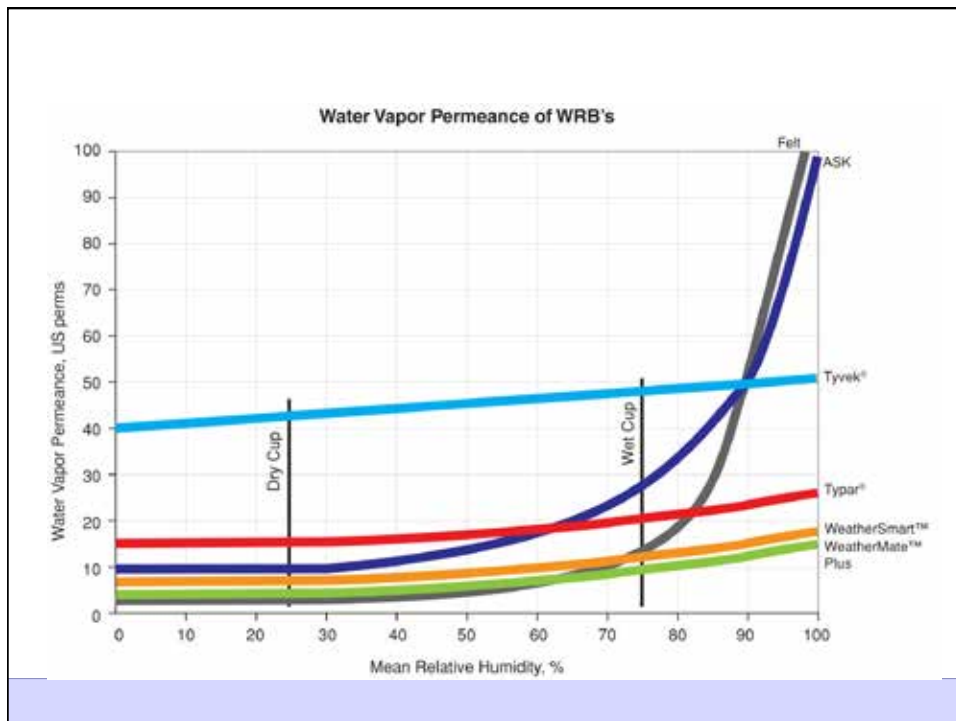
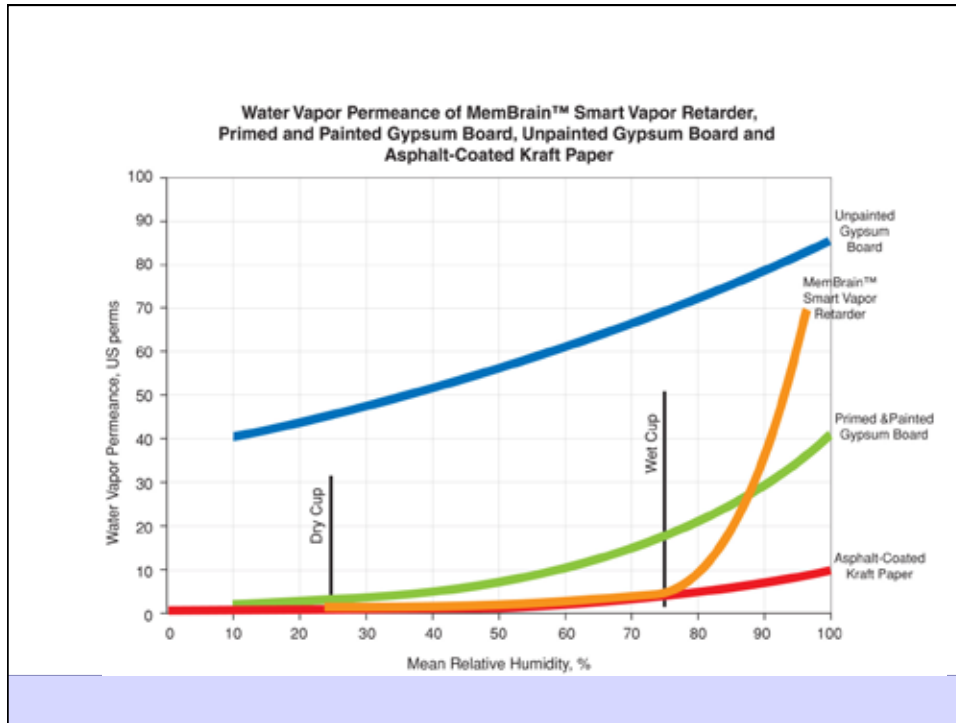

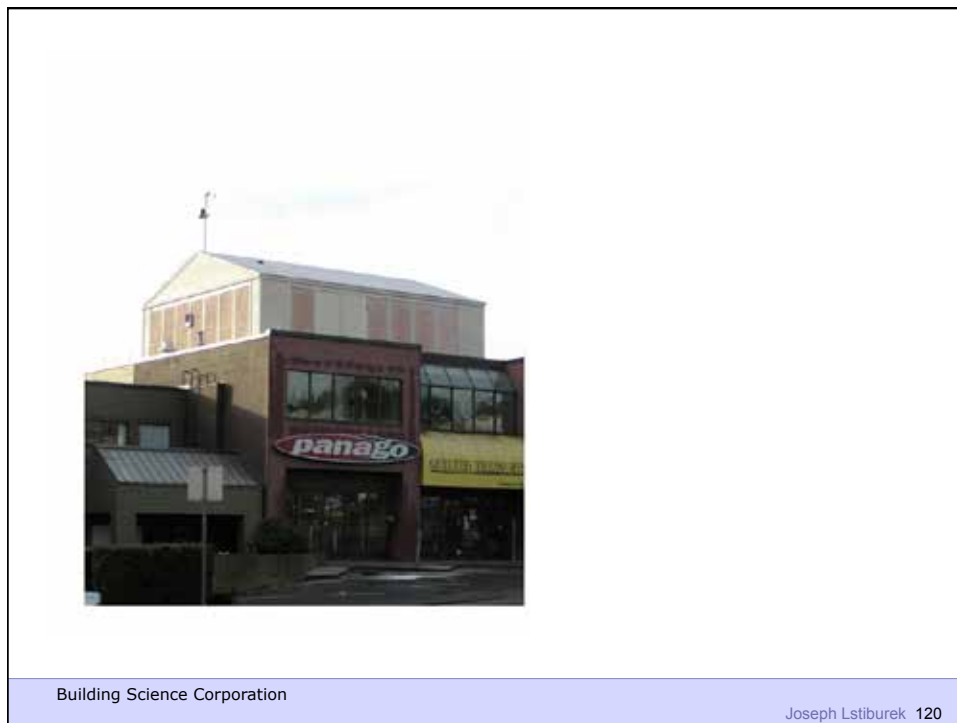
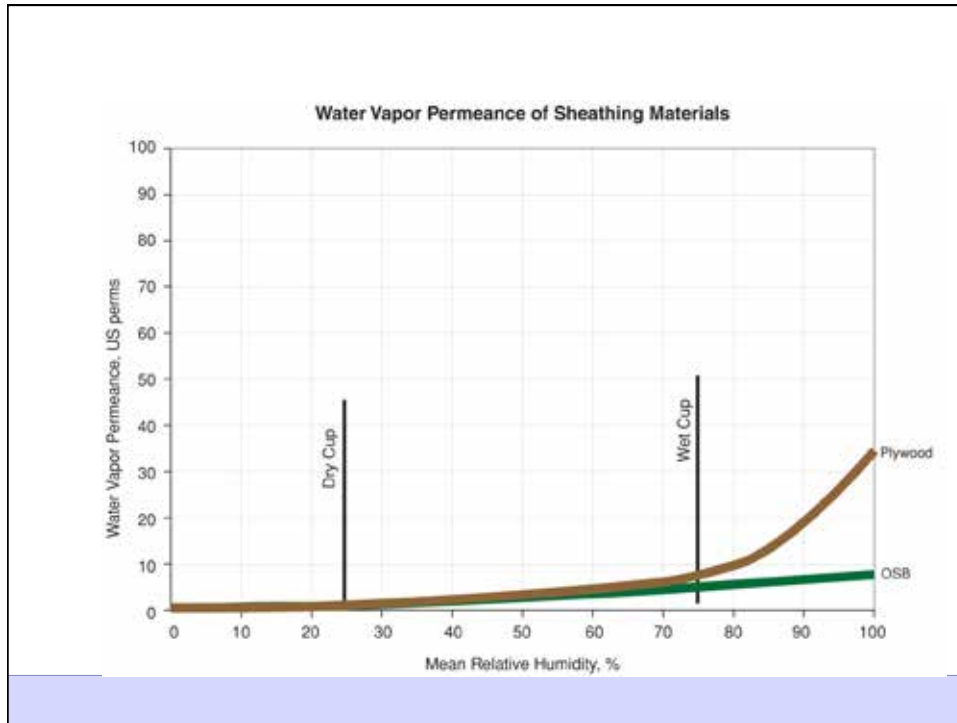

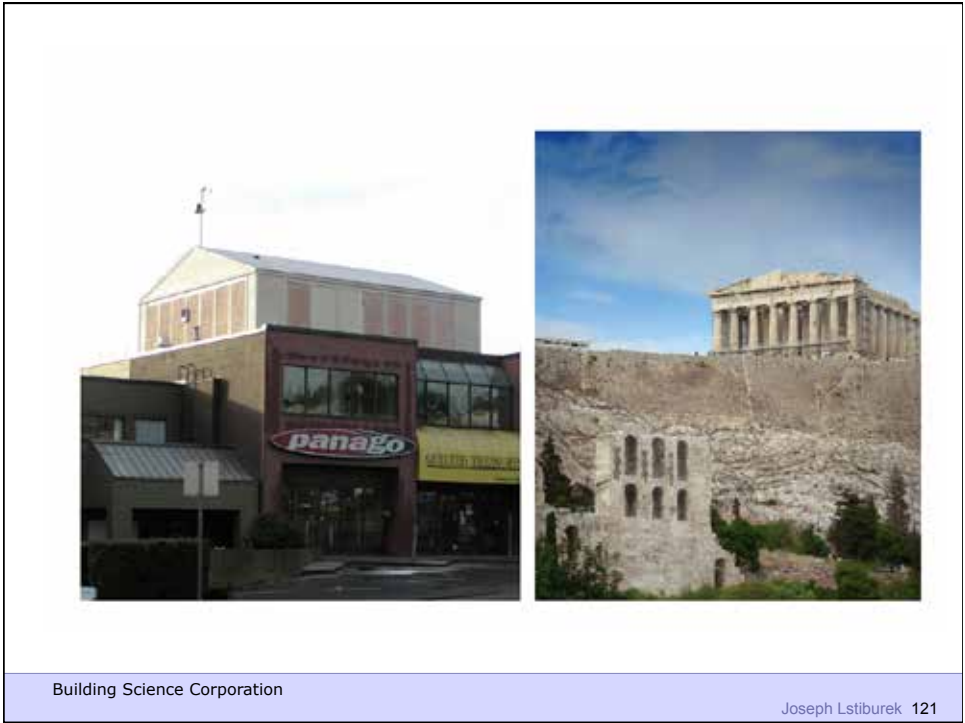



Building Science Corporation

Joseph Lstiburek 123



Building Science Corporation

Joseph Lstiburek 124



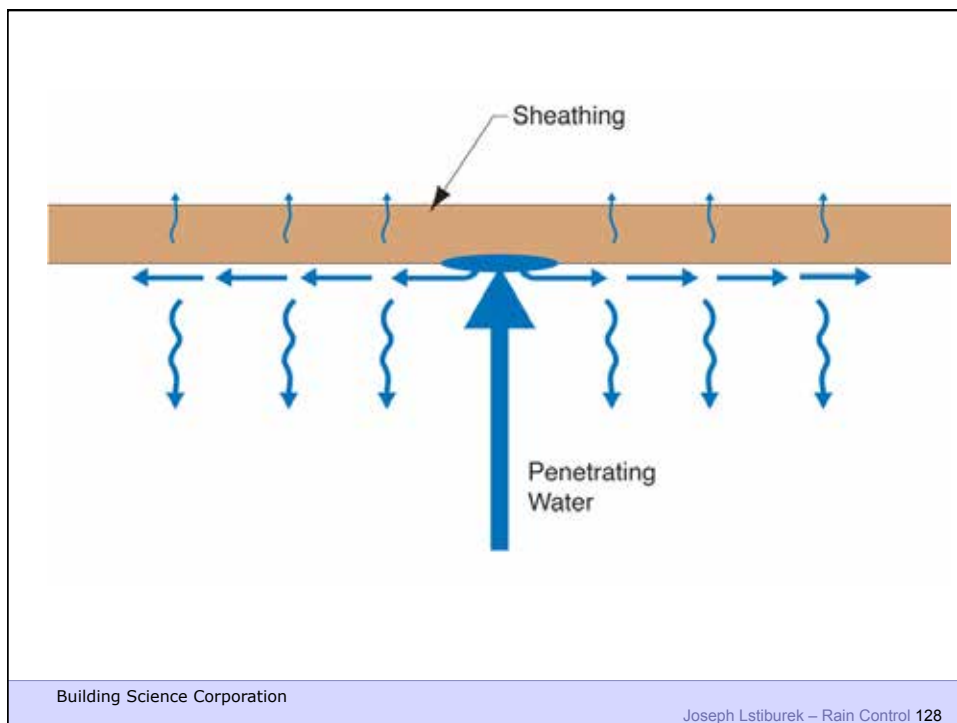
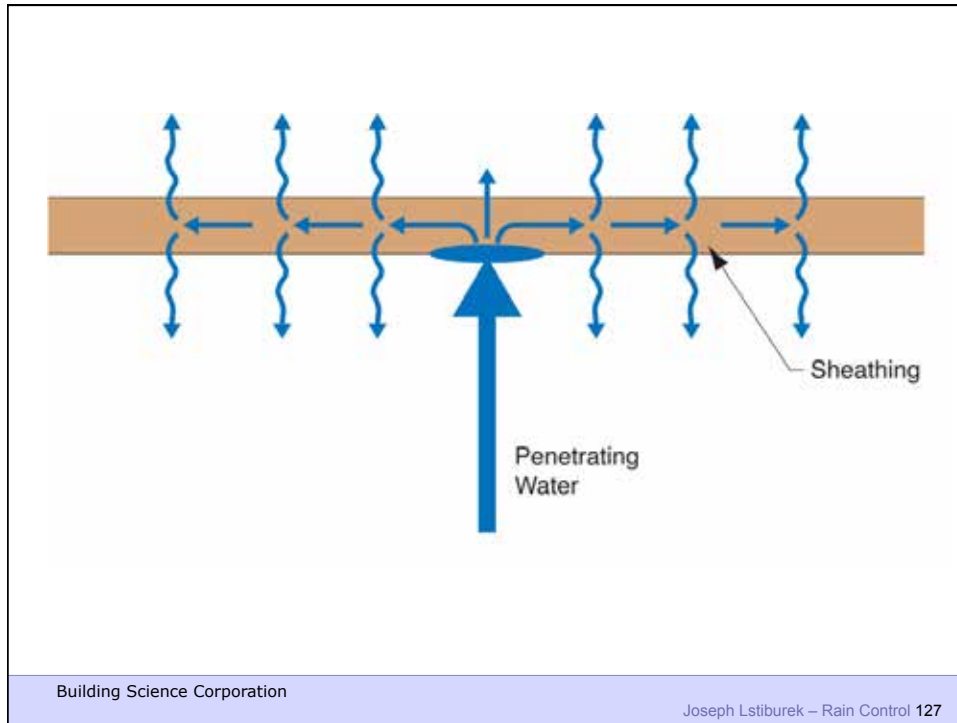



Building Science Corporation

Joseph Lstiburek – Rain Control 129

Rain Screen

Building Science Corporation

Joseph Lstiburek 130

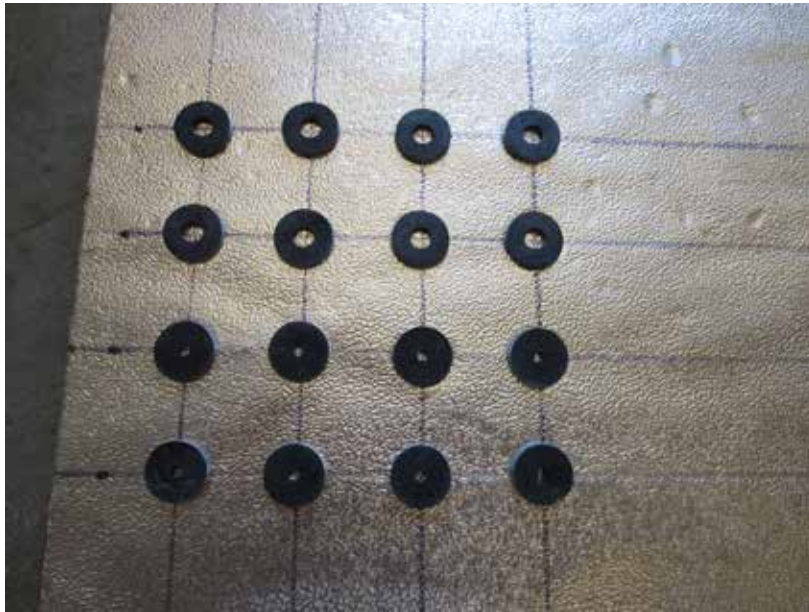

Building Science Corporation

Joseph Lstiburek 131

Beer Screen?

Building Science Corporation

Joseph Lstiburek 132

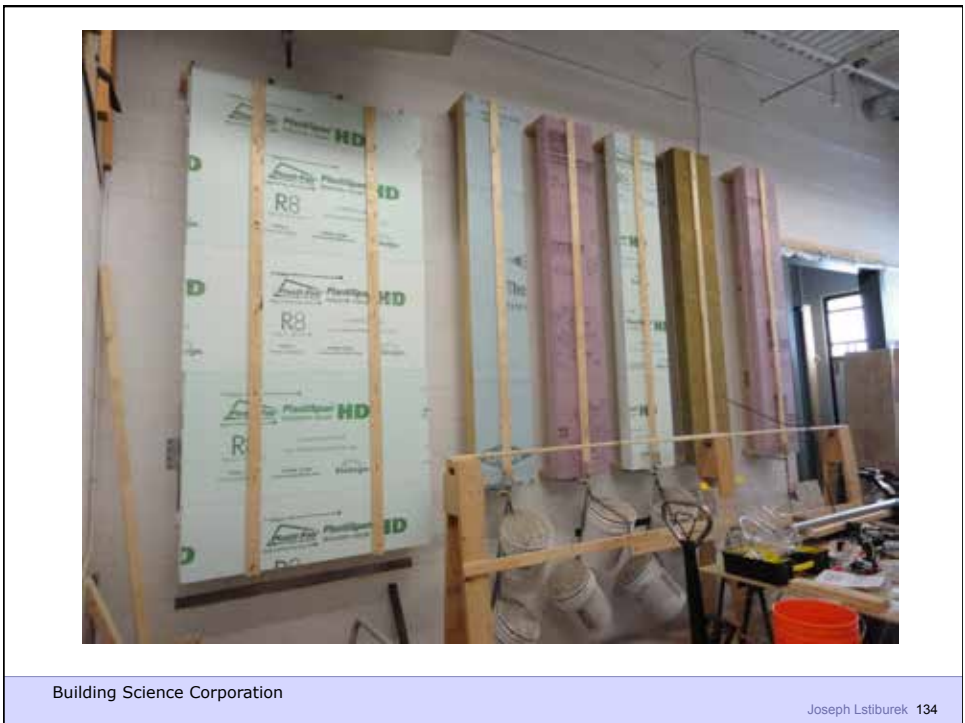
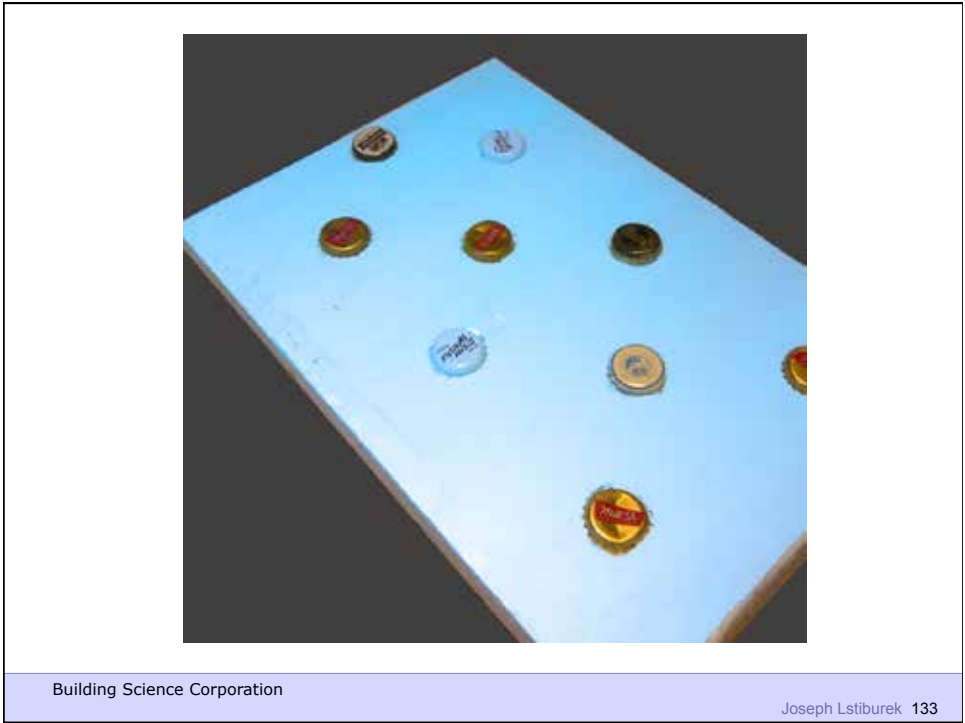

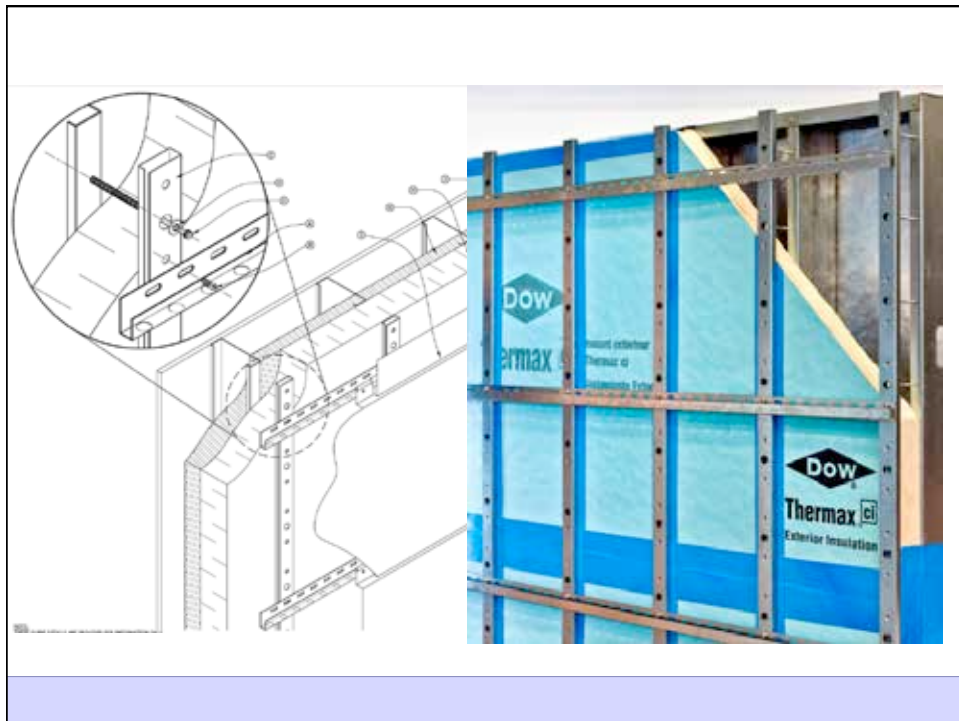

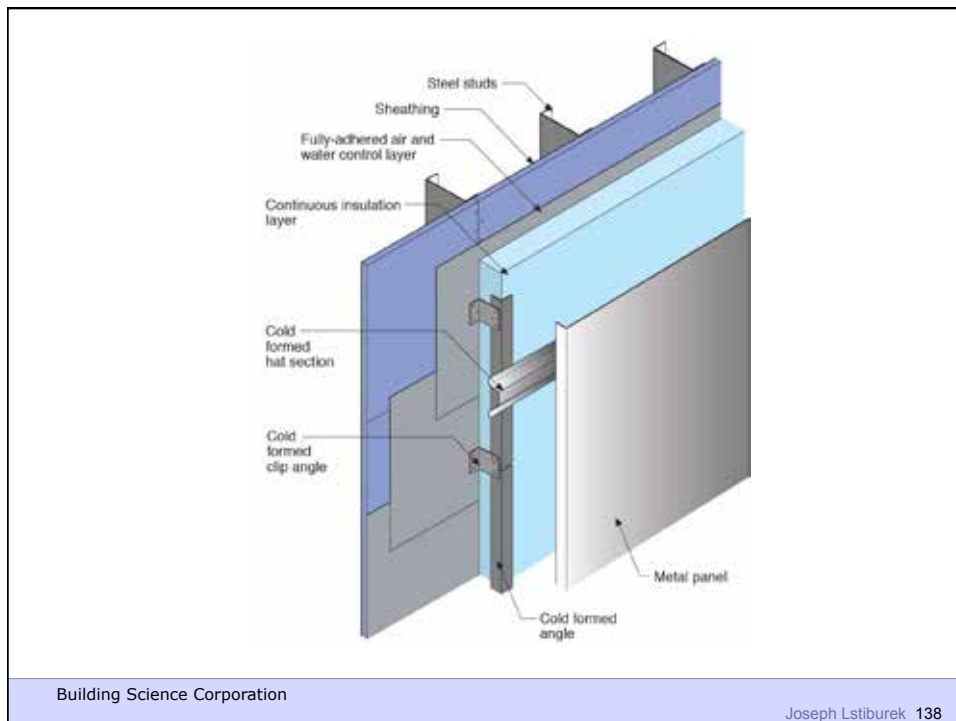
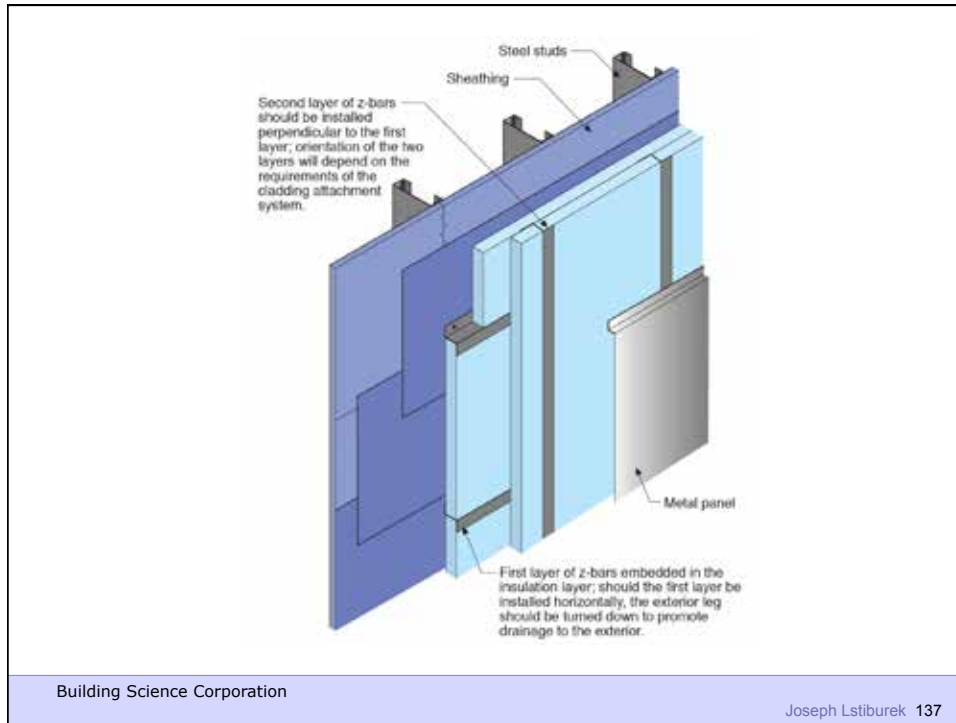

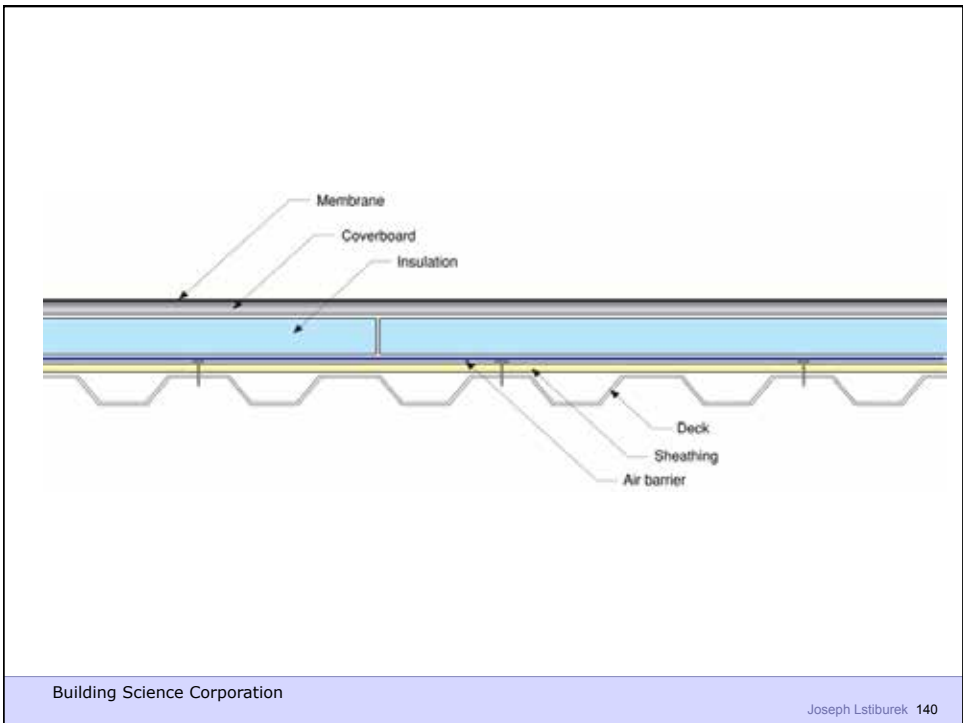
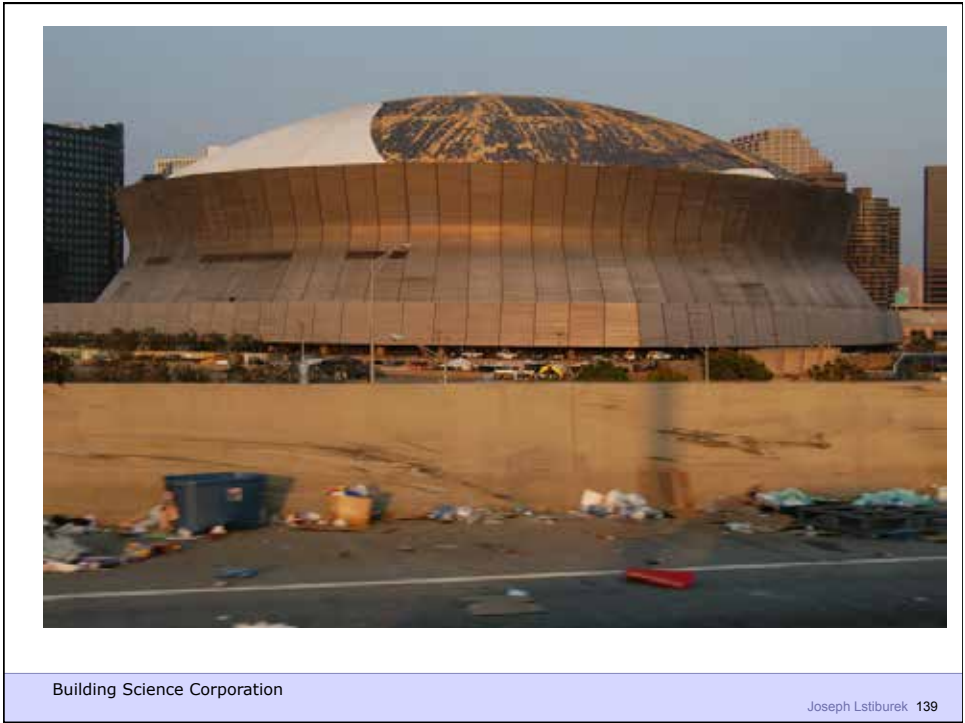

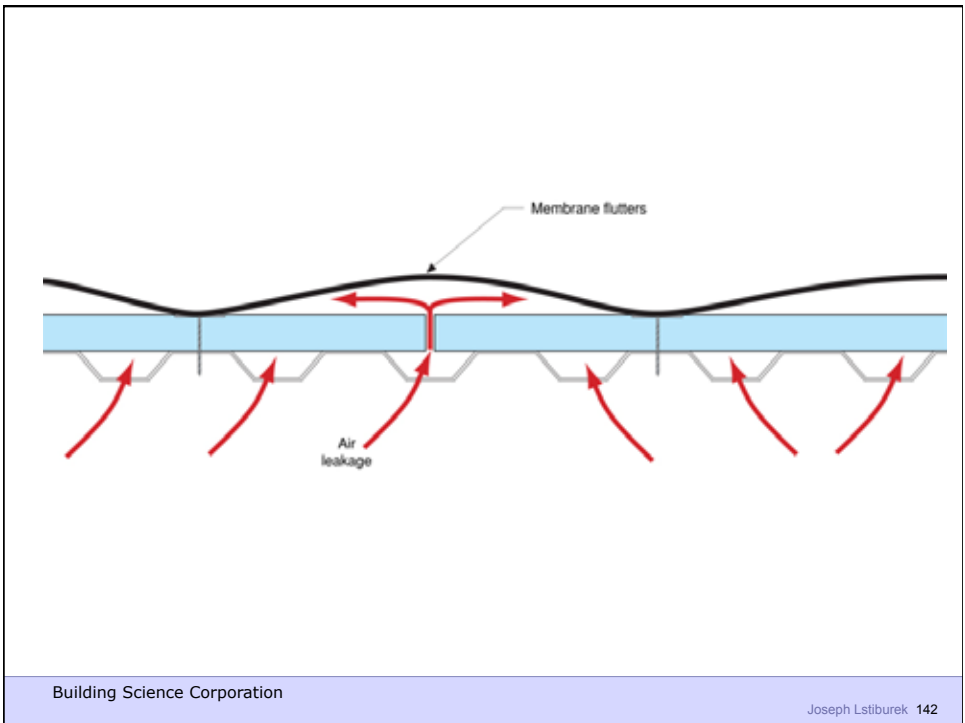





Building Science Corporation

Joseph Lstiburek 145



Building Science Corporation

Joseph Lstiburek 146

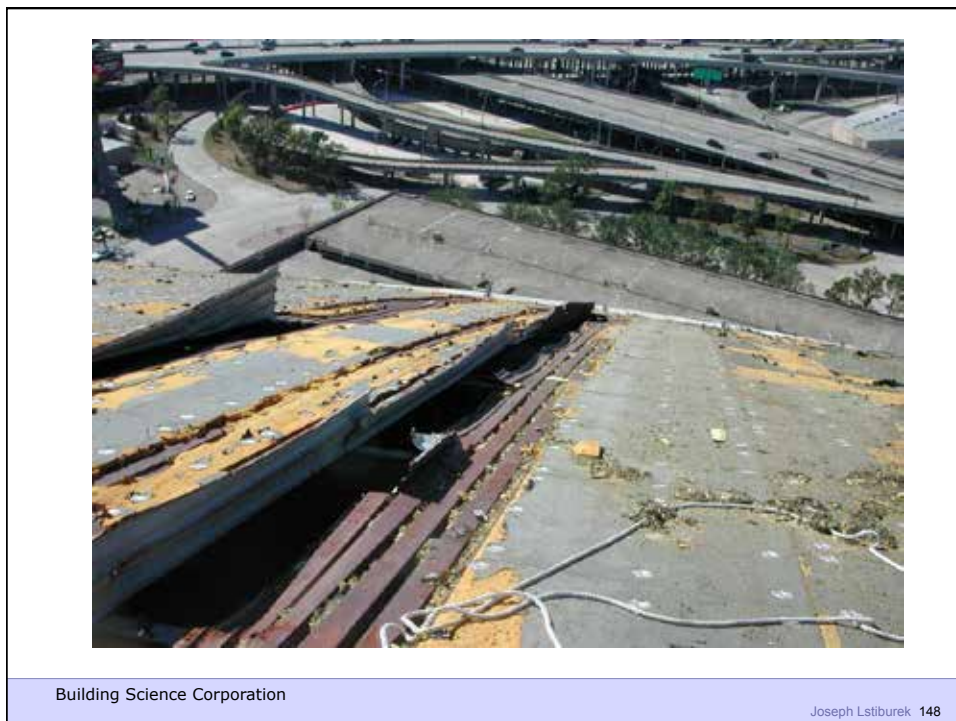
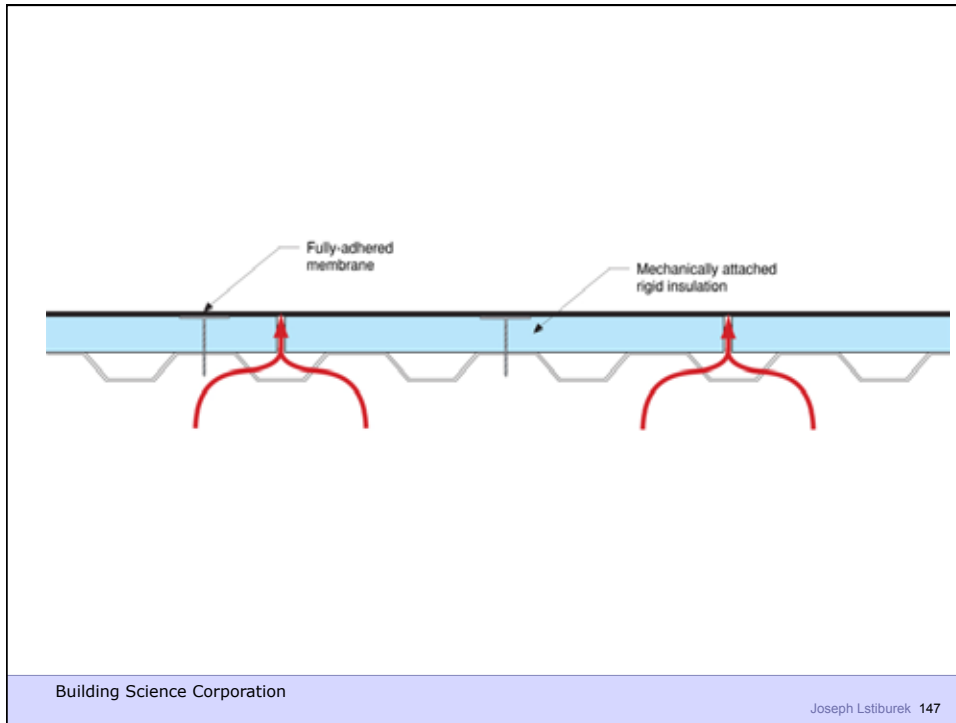

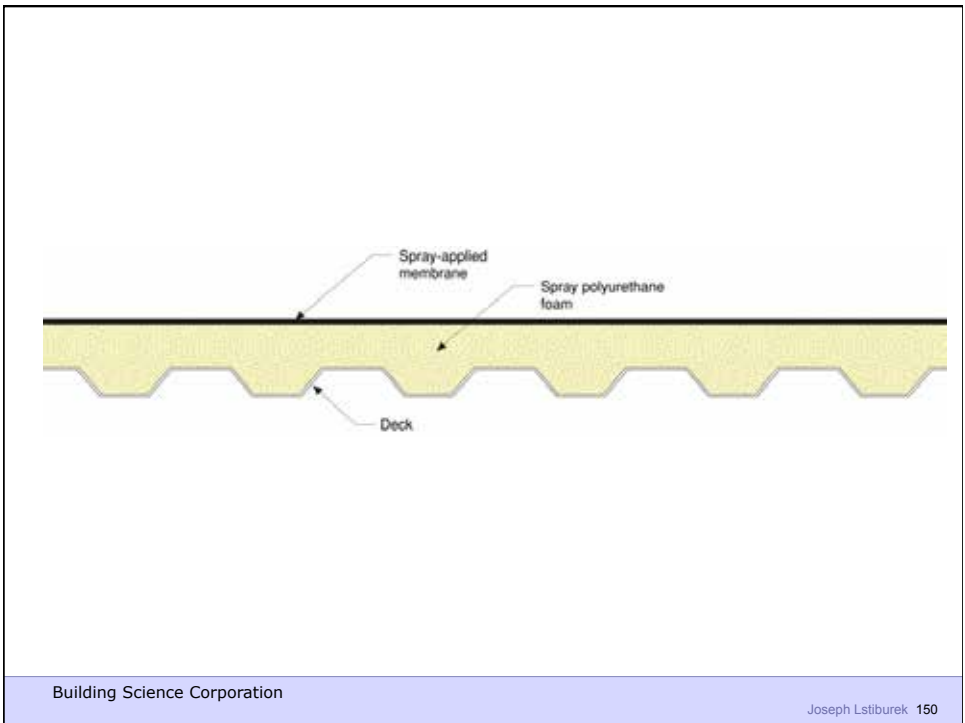
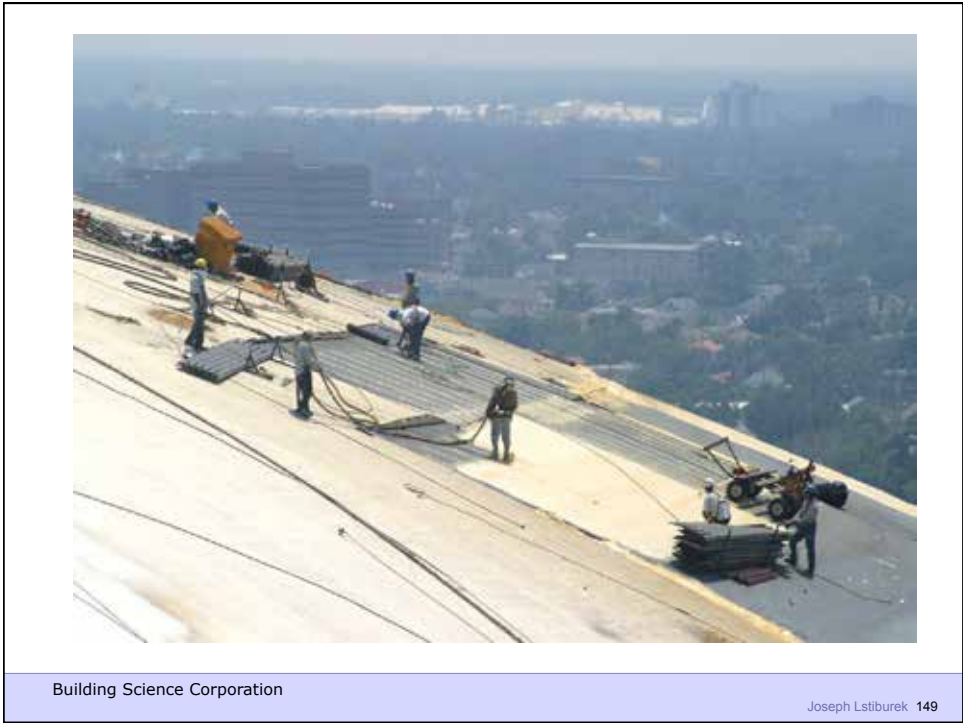



Building Science Corporation

Joseph Lstiburek 151

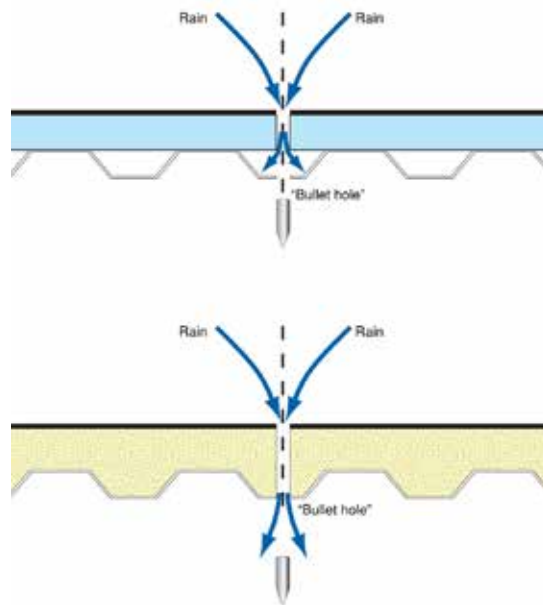

Building Science Corporation

Joseph Lstiburek 152



Building Science Corporation

Joseph Lstiburek 153



Building Science Corporation

Joseph Lstiburek 154

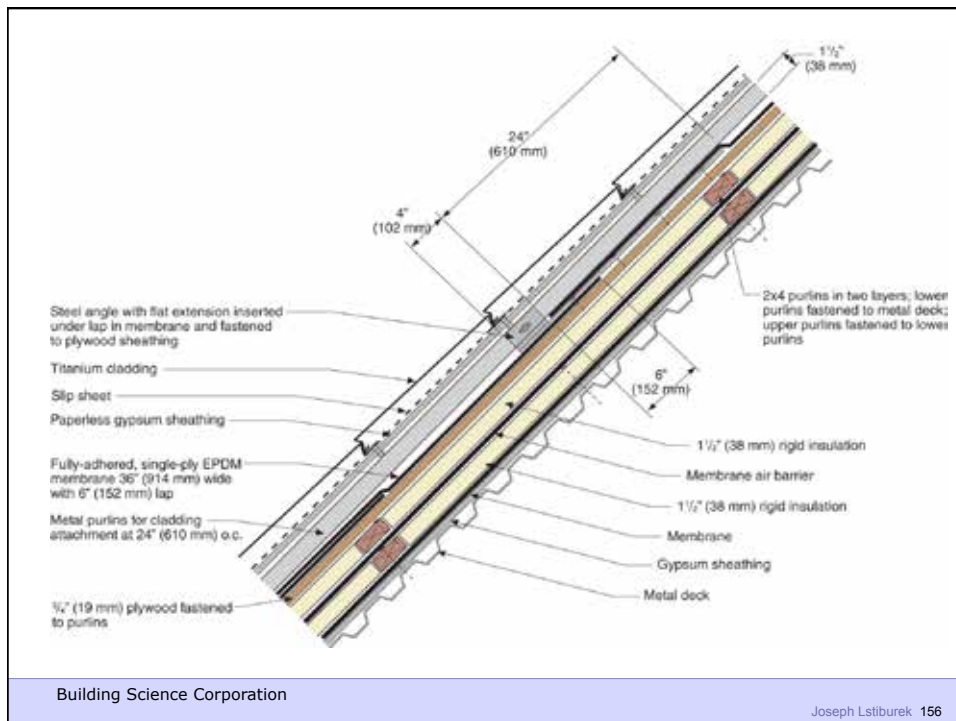
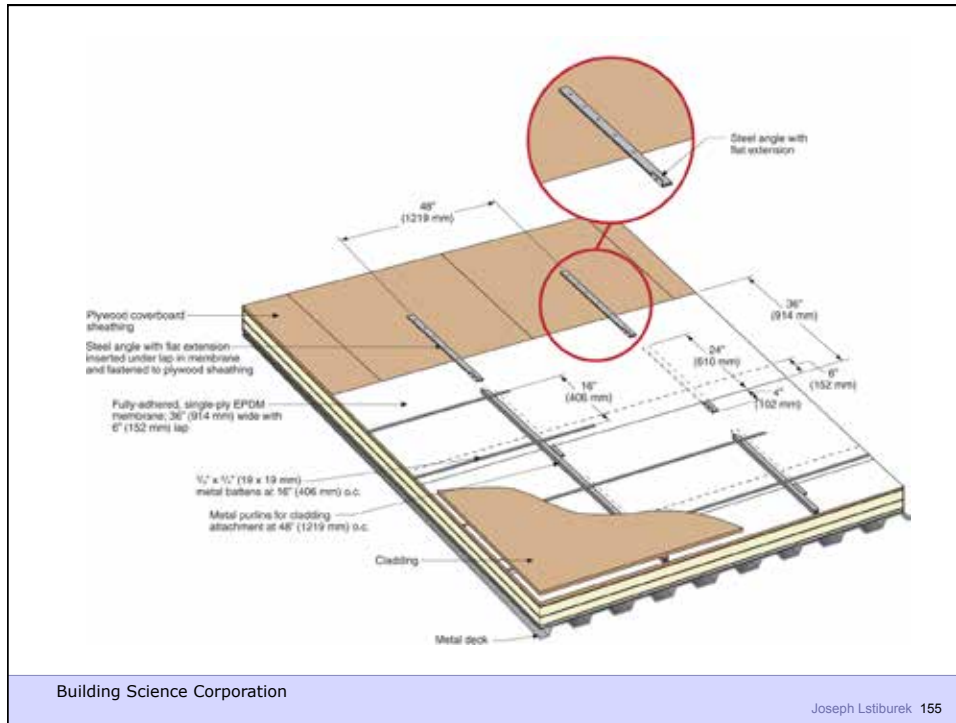

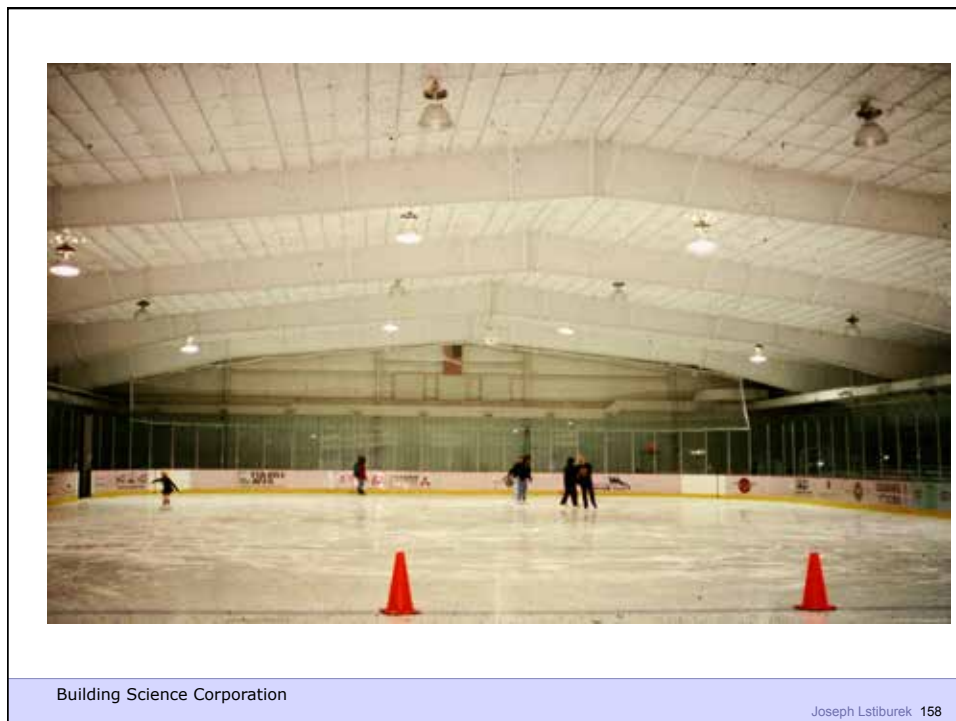
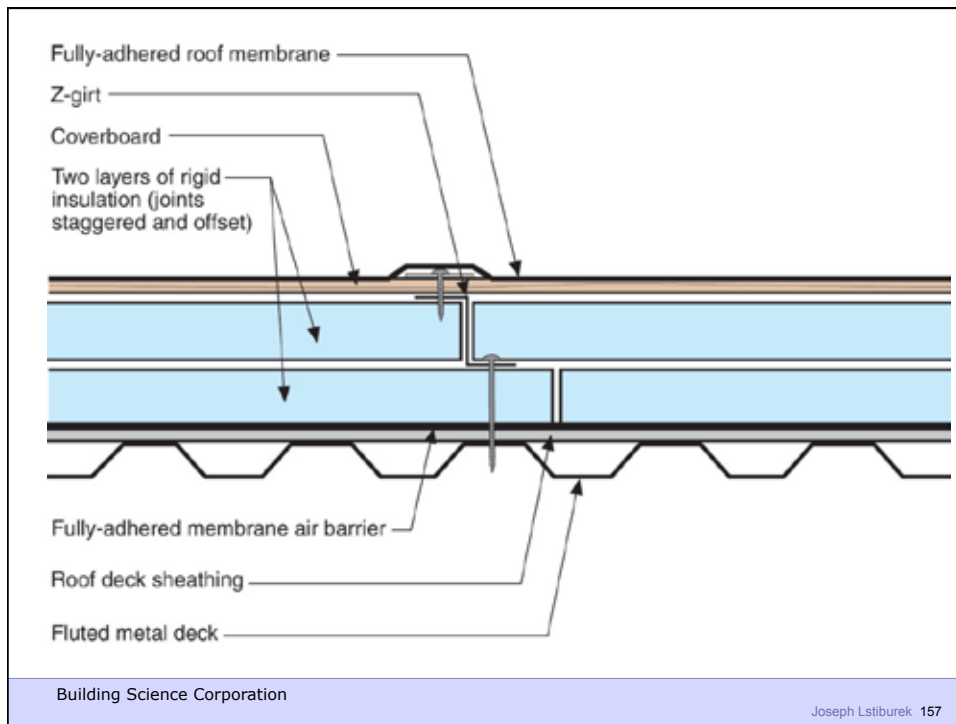



Building Science Corporation

Joseph Lstiburek 159



Building Science Corporation

Joseph Lstiburek 160





Building Science Corporation

Joseph Lstiburek 163



Building Science Corporation

Joseph Lstiburek 164





Building Science Corporation

Joseph Lstiburek 167



Building Science Corporation

Joseph Lstiburek 168



Building Science Corporation

Joseph Lstiburek 169



Building Science Corporation

Joseph Lstiburek 170



Building Science Corporation

Joseph Lstiburek 171

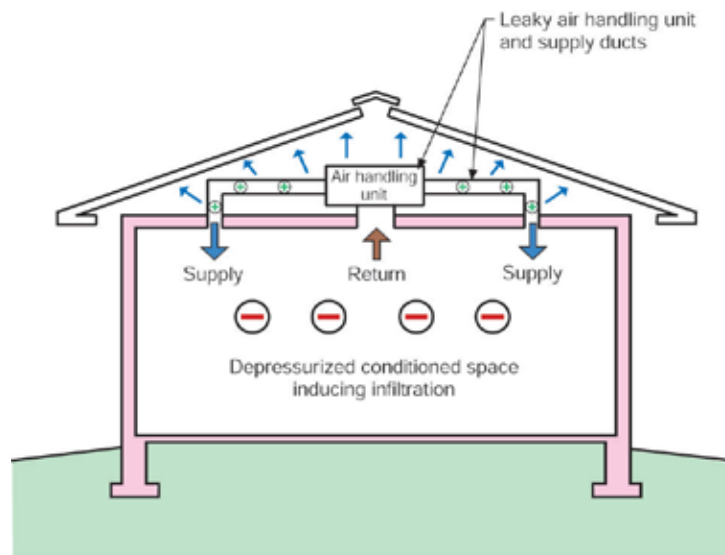

Note: Colored shading depicts the building's thermal barrier and pressure boundary. The thermal barrier and pressure boundary enclose the conditioned space.

Building Science Corporation

Joseph Lstiburek 172

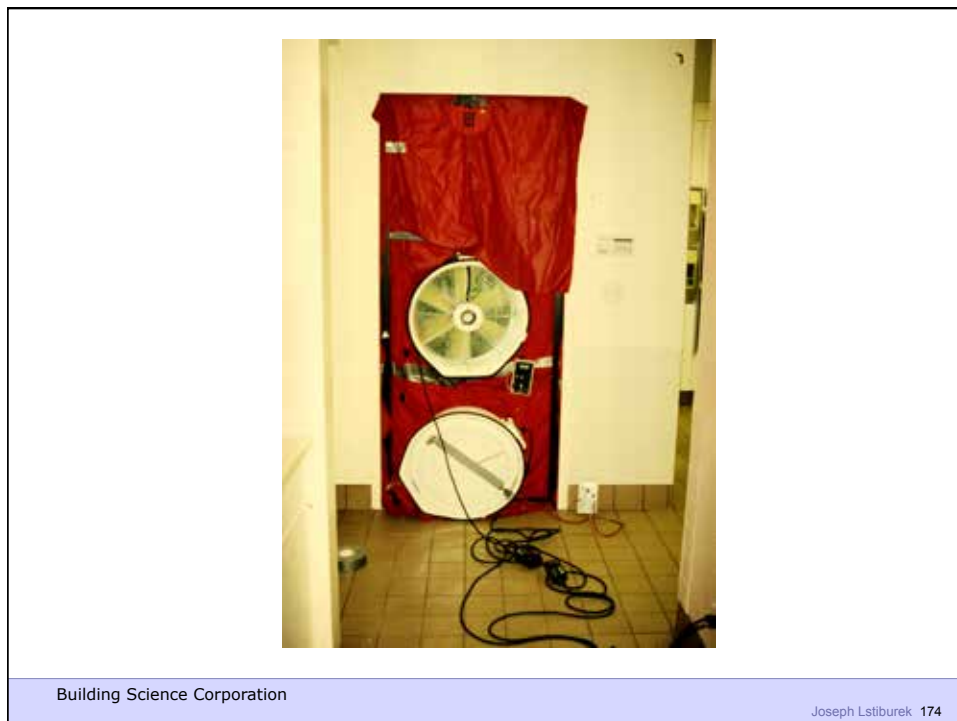
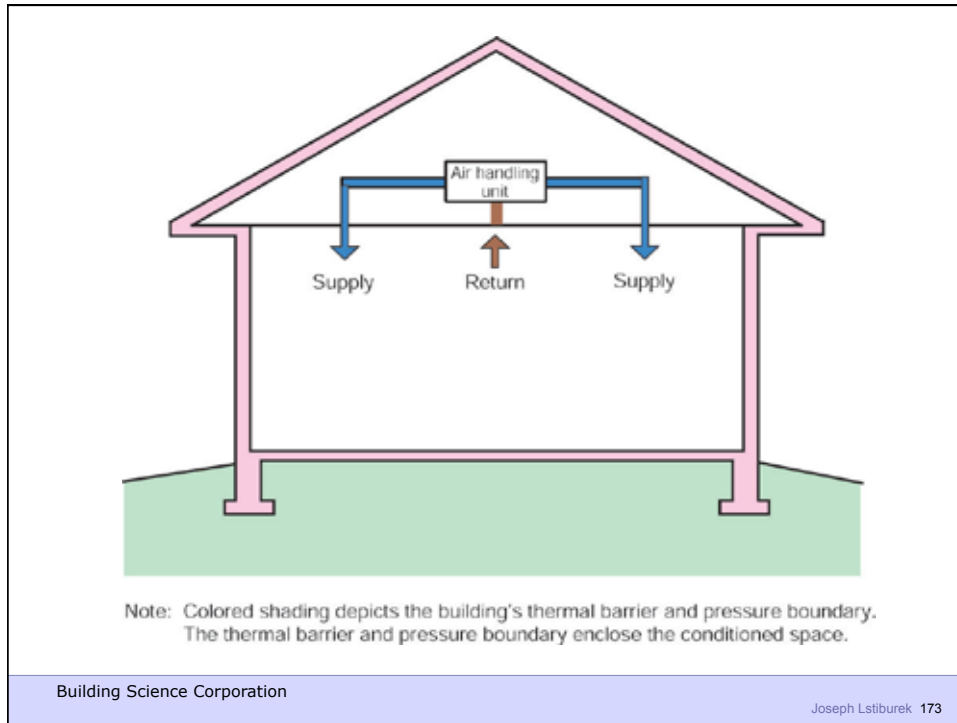



Building Science Corporation

Joseph Lstiburek 175



Building Science Corporation

Joseph Lstiburek 176



Building Science Corporation

Joseph Lstiburek 177



Building Science Corporation

Joseph Lstiburek 178

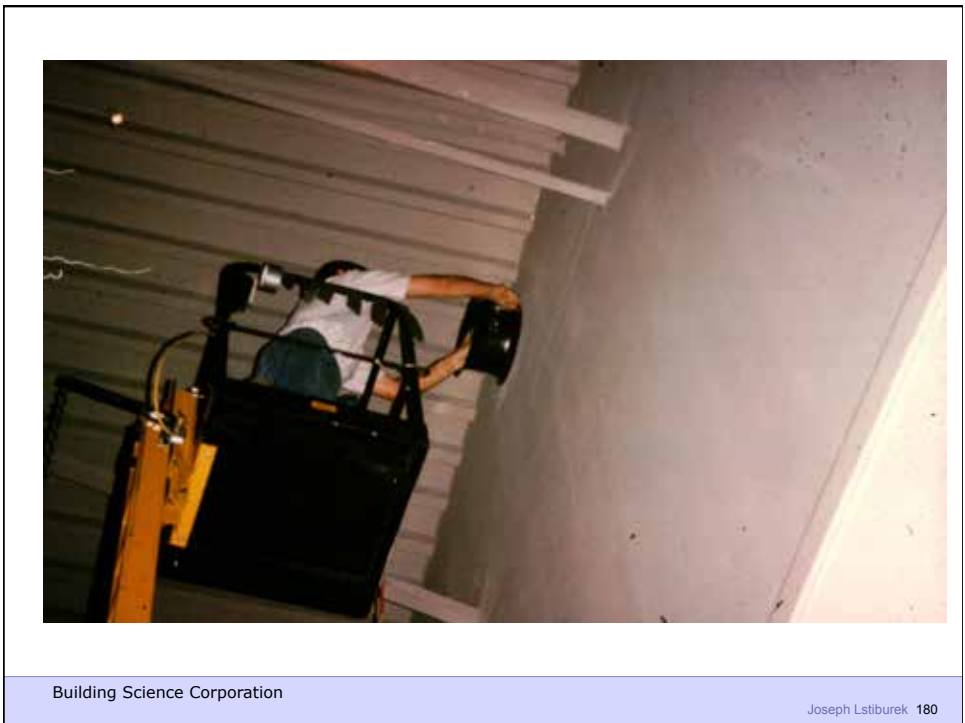



Building Science Corporation

Joseph Lstiburek 181



Building Science Corporation

Joseph Lstiburek 182





Building Science Corporation

Joseph Lstiburek 185



Building Science Corporation

Joseph Lstiburek 186

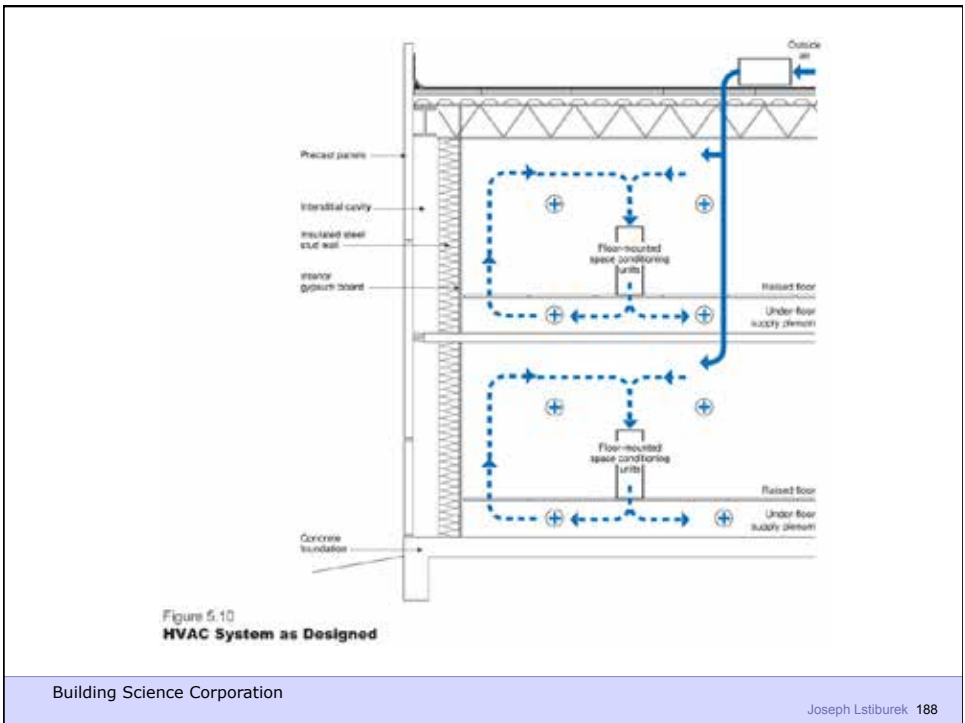

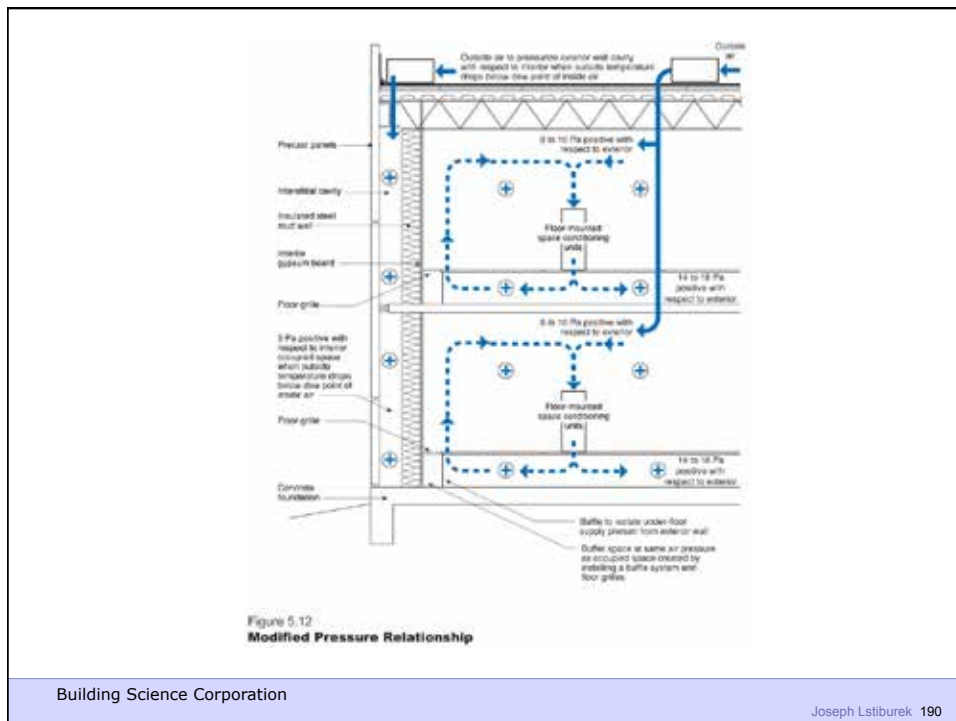
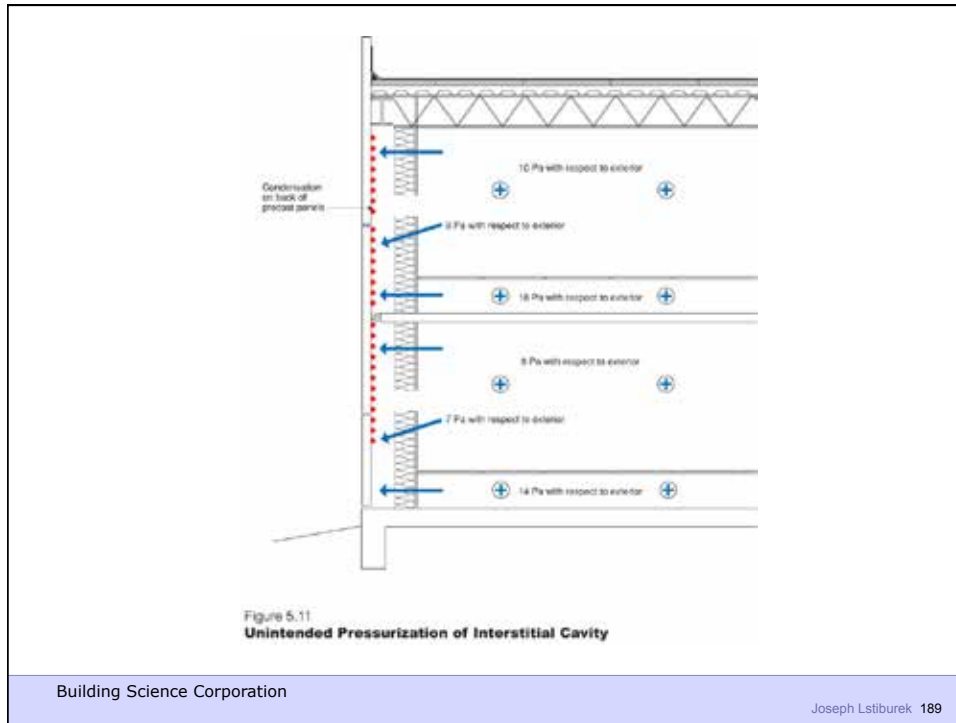

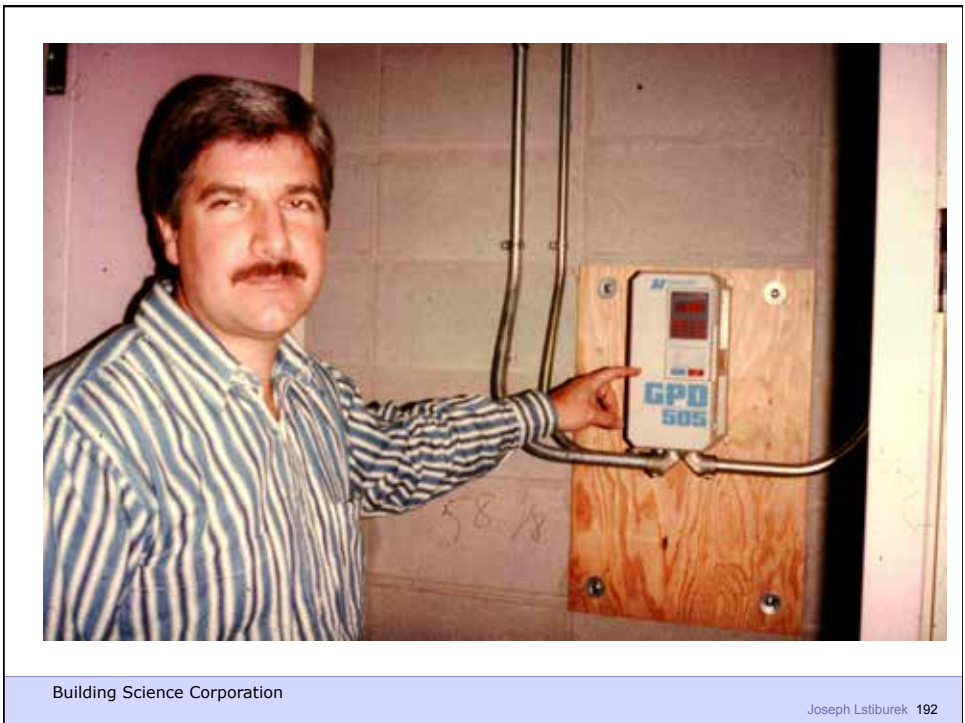



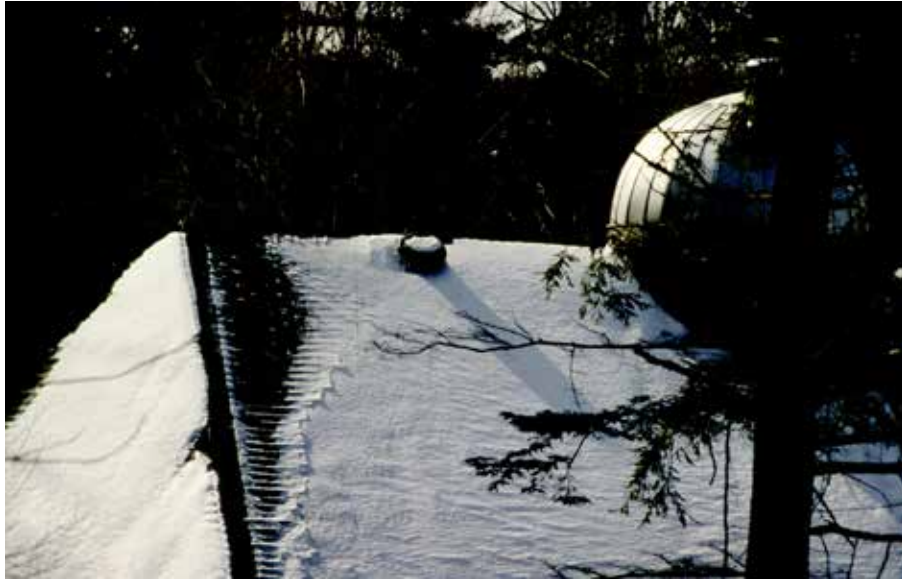

Building Science Corporation

Joseph Lstiburek 195

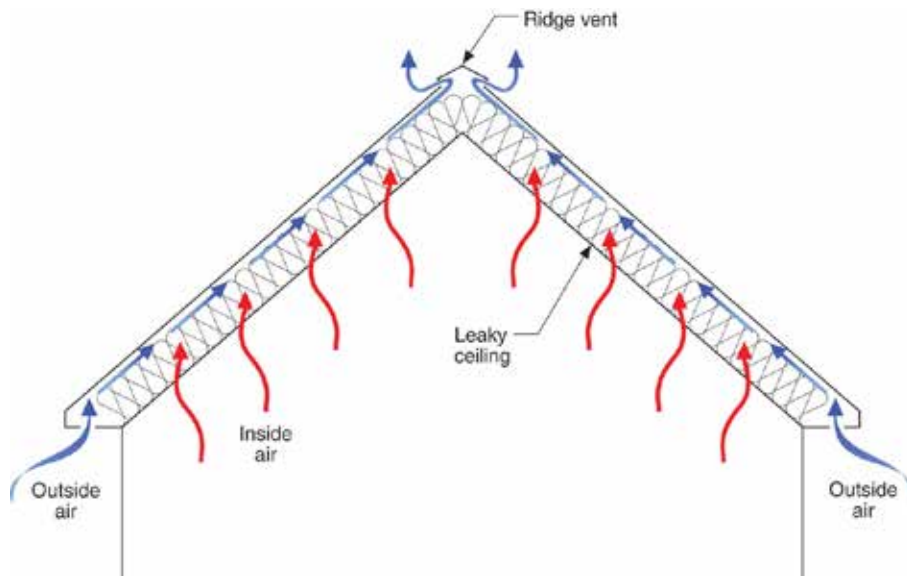

Building Science Corporation

Joseph Lstiburek 196

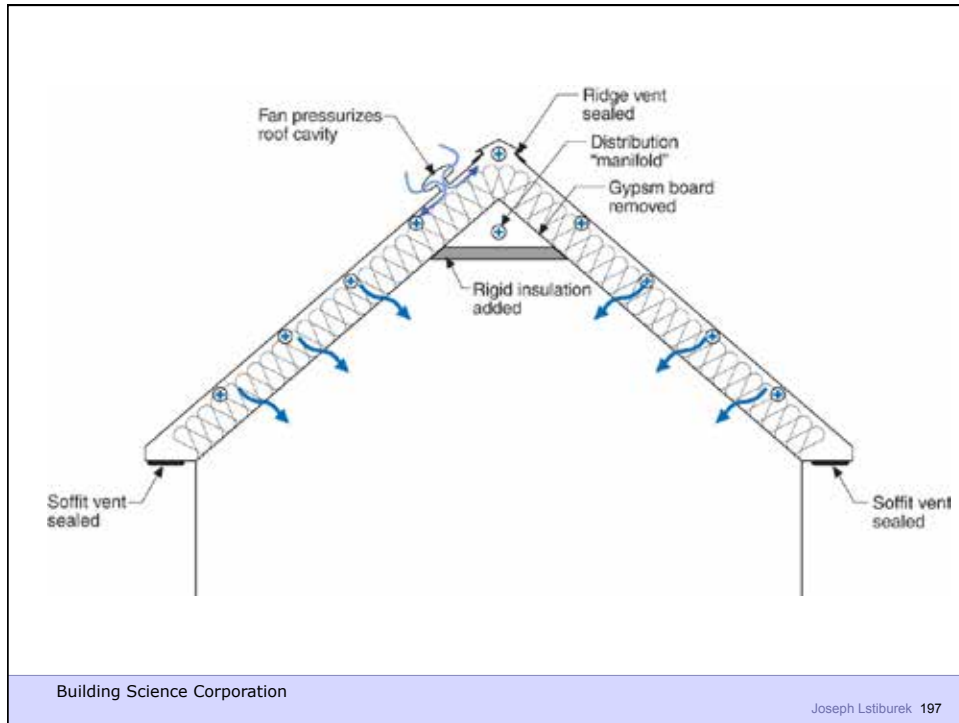





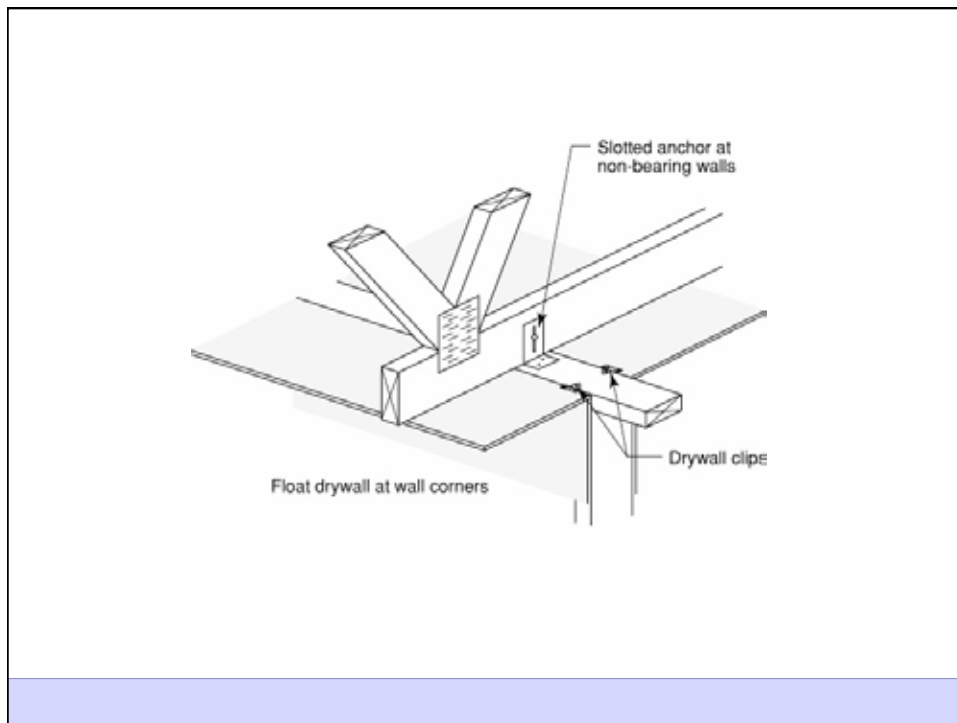
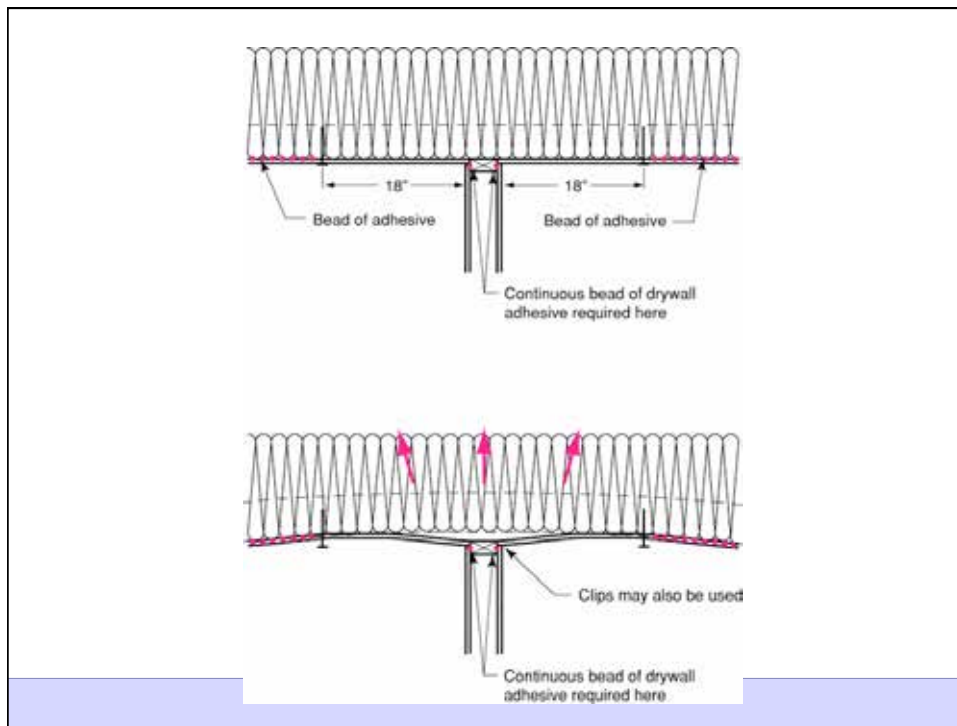

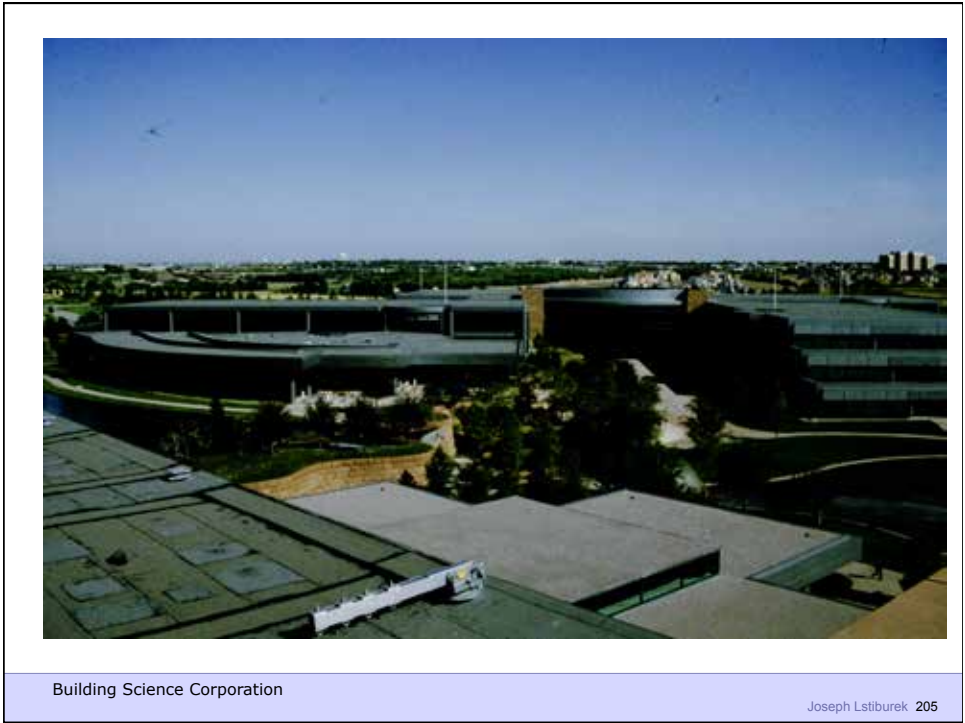

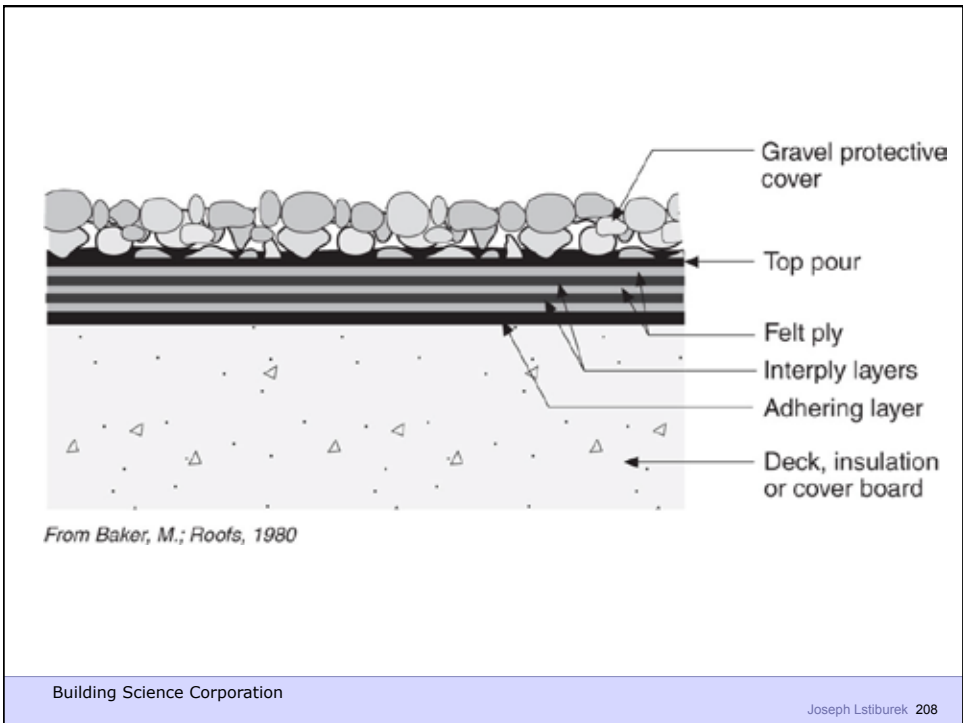

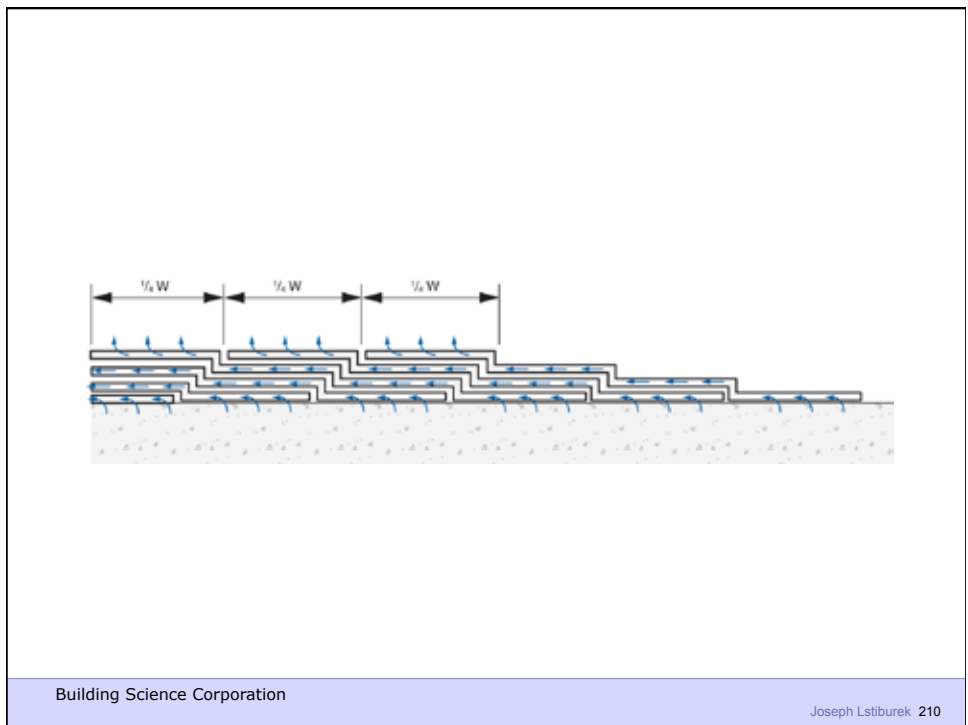
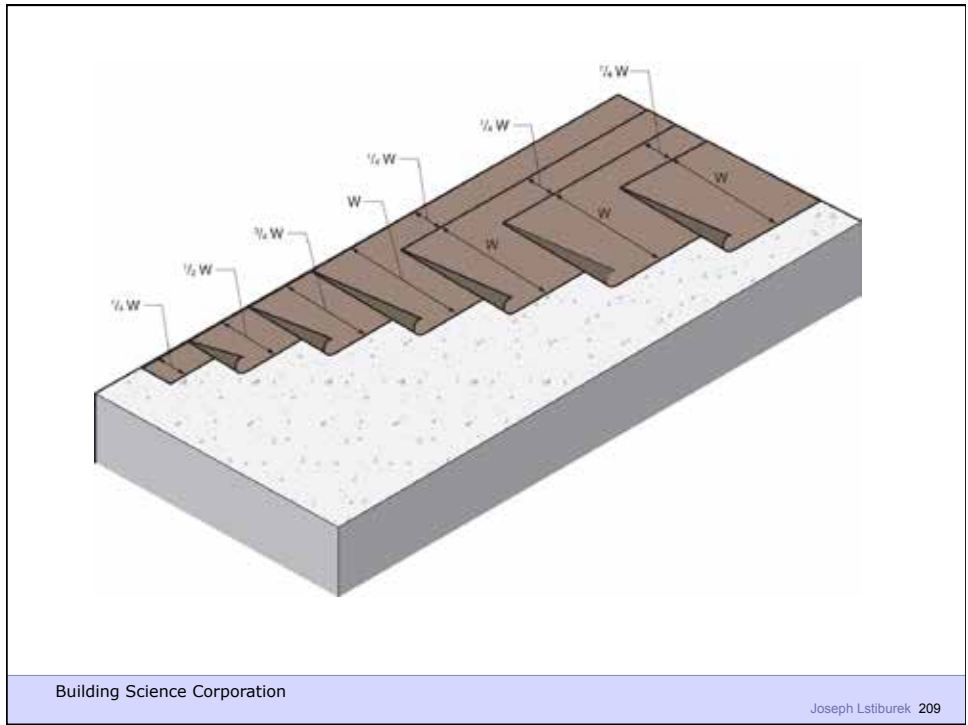

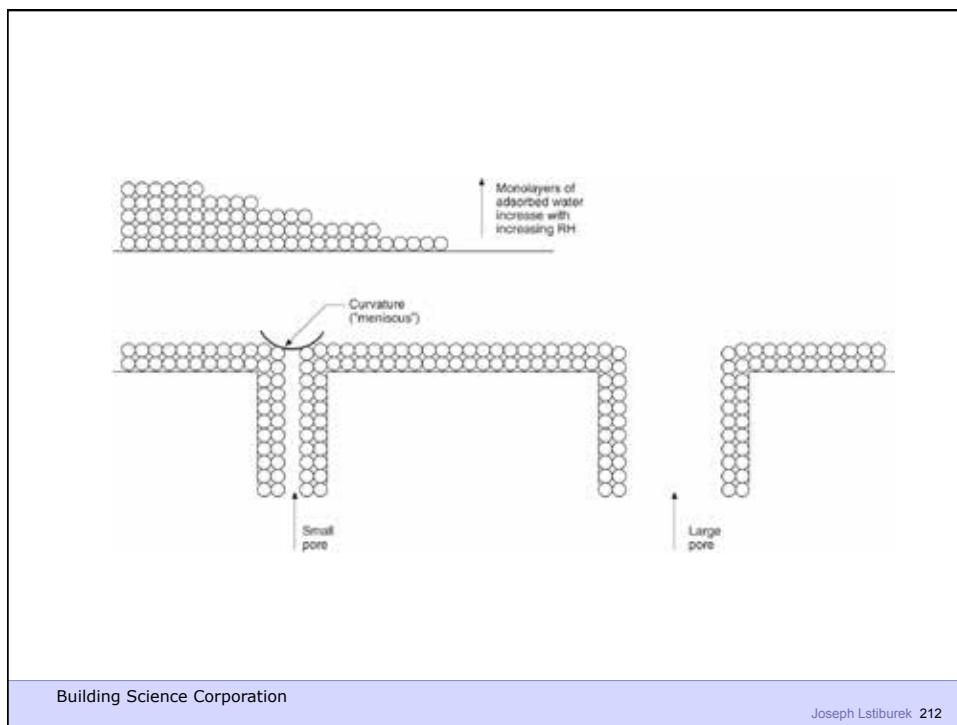
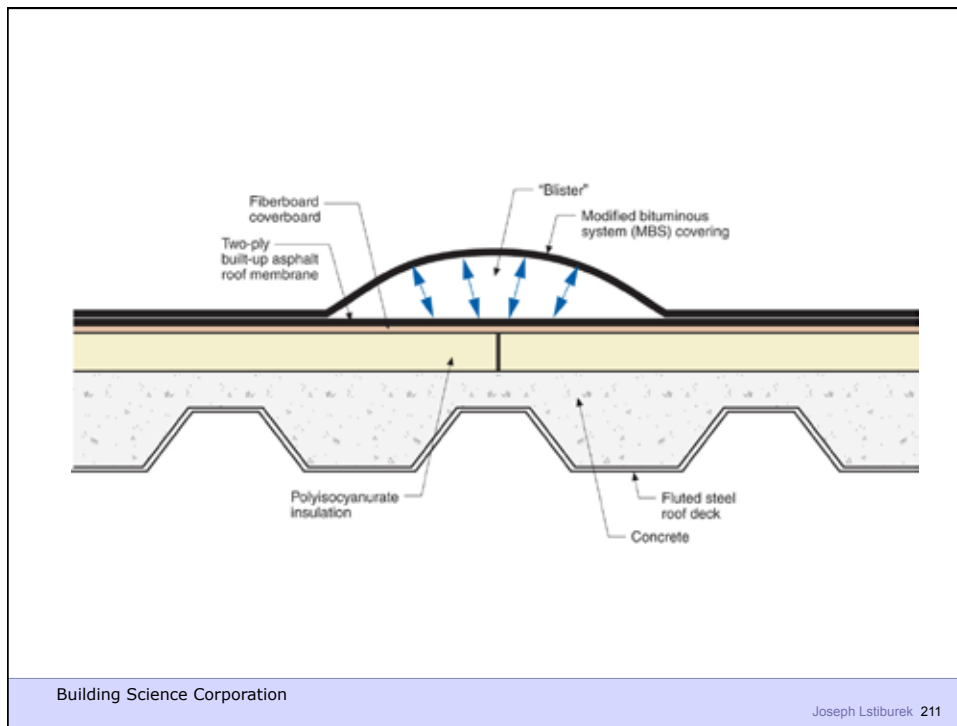

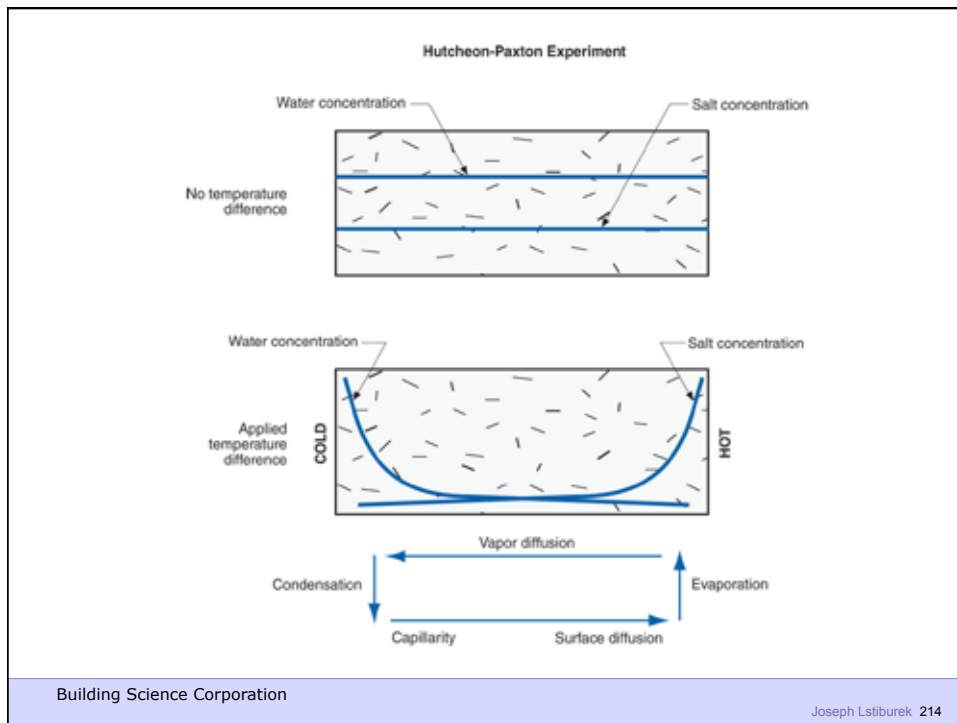
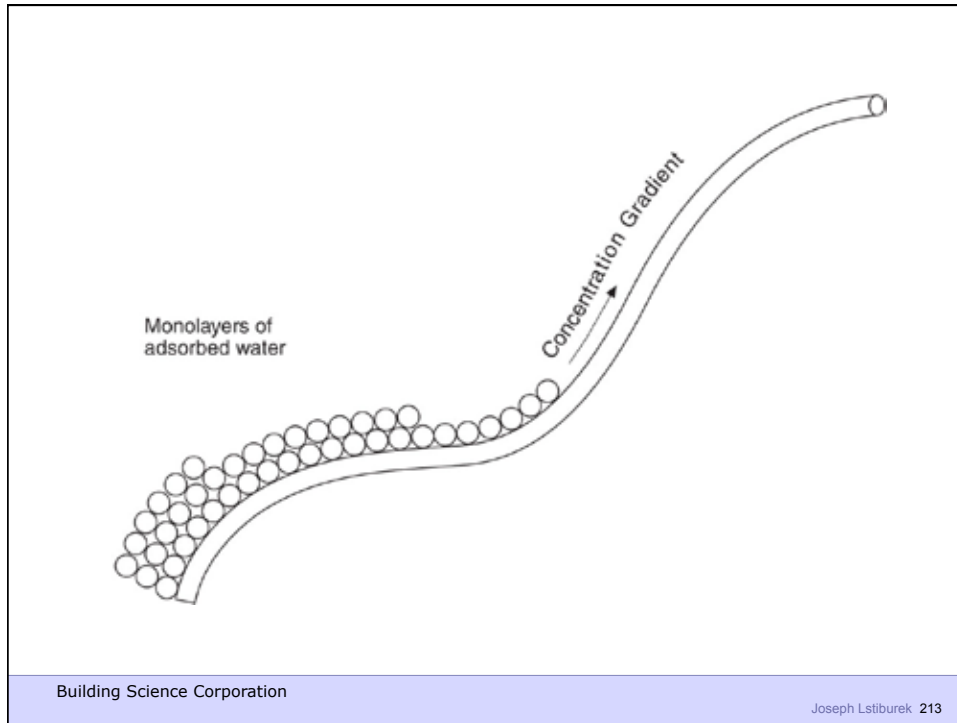



Building Science Corporation

Joseph Lstiburek 215



Building Science Corporation

Joseph Lstiburek 216



Building Science Corporation

Joseph Lstiburek 217

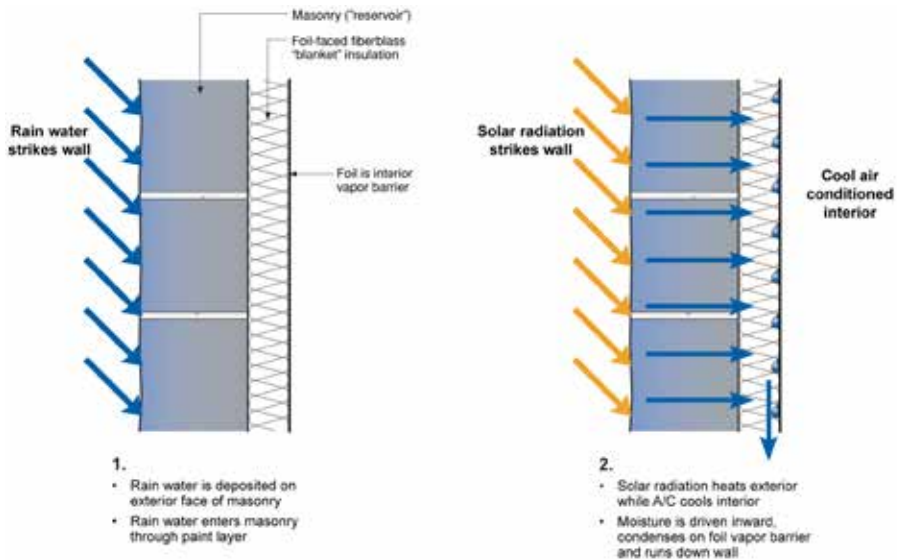

Building Science Corporation

Joseph Lstiburek 218

